

SMART Board®

7000R and 7000R Pro series

interactive displays

INSTALLATION AND MAINTENANCE GUIDE

SBID-7275R | SBID-7286R | SBID-7275R-P | SBID-7286R-P

SBID-7075R | SBID-7086R | SBID-7075R-P | SBID-7086R-P

IDR775-1 | IDR786-1

Was this document helpful?
smarttech.com/docfeedback/171538

SMART®



Learn more

This guide and other resources for SMART Board 7000R and 7000R Pro series interactive displays are available in the Support section of the SMART website (smarttech.com/support). Scan this QR code to view these resources on your mobile device.

Licenses

The terms HDMI and HDMI High-Definition Multimedia Interface, and the HDMI logo are trademarks or registered trademarks of HDMI Licensing LLC in the United States and other countries.

The Bluetooth word mark is owned by the Bluetooth SIG, Inc. and any use of such marks by SMART Technologies ULC is under license.

Trademark notice

SMART Board, SMART Notebook, SMART TeamWorks, SMART Meeting Pro, SMART Ink, HyPr Touch, Silktouch, Object Awareness, Pen ID, smarttech, the SMART logo and all SMART taglines are trademarks or registered trademarks of SMART Technologies ULC in the U.S. and/or other countries. Microsoft and Windows are either registered trademarks or trademarks of Microsoft Corporation in the United States and/or other countries. All other third-party product and company names may be trademarks of their respective owners.

Copyright notice

© 2020 SMART Technologies ULC. All rights reserved. No part of this publication may be reproduced, transmitted, transcribed, stored in a retrieval system or translated into any language in any form by any means without the prior written consent of SMART Technologies ULC. Information in this manual is subject to change without notice and does not represent a commitment on the part of SMART.

This product and/or use thereof is covered by one or more of the following U.S. patents:

www.smarttech.com/patents

April 30, 2020

Important information

STABILITY HAZARD

If not installed properly, this display may fall causing serious injury or death. To prevent injury, the display must be securely attached to the wall following the installation instructions.

WARNING

- Failure to follow the installation instructions included with the display could result in injury and product damage which may not be covered by the warranty.
- Do not open or disassemble the display. You risk electrical shock from the high voltage inside the casing. Opening the casing also voids the warranty.
- Do not stand (or allow children to stand) on a chair to touch the surface of the display. Rather, mount the product at the appropriate height.
- To reduce the risk of fire or electric shock, do not expose the display to rain or moisture.
- If the display requires replacement parts, make sure the service technician uses replacement parts specified by SMART Technologies or parts with the same characteristics as the original.
- Ensure that any cables that cross the floor to the display are properly bundled and marked to avoid a trip hazard.
- Do not insert objects inside the cabinet ventilation holes, because they could touch dangerous voltage points and cause electric shock, fire, or product damage which may not be covered by the warranty.
- Do not place heavy objects on the power cable. Damage to the cable could cause shock, fire, or product damage which may not be covered by the warranty.
- Use only extension cords and outlets that can fully accommodate the display's polarized plug.
- Use the power cable provided with the display. If a power cable is not supplied, contact your supplier. Use only power cables that match the AC voltage of the power outlet and that comply with your country's safety standards.
- If the glass is broken, do not touch the liquid crystal. To prevent injury, handle glass fragments with care when disposing of them.
- Do not move or mount the display by connecting rope or wire to its handles. The display is heavy, and failure of the rope, wire, or handle could lead to injury.

- Use only VESA-approved mounts.
- Disconnect all of the display's power cables from the wall outlet and seek assistance from qualified service personnel if any of the following occur:
 - The power cable or plug is damaged
 - Liquid is spilled into the display
 - Objects fall into the display
 - The display is dropped
 - Structural damage, such as cracking, occurs
 - The display behaves unexpectedly when you follow operating instructions

CAUTION

- Turn off the display before cleaning its screen. Otherwise, you may scramble the desktop icons or inadvertently activate applications when you wipe the screen.
- Avoid setting up and using the display in an area with excessive levels of dust, humidity, and smoke.
- Make sure an electrical socket is near the display and remains easily accessible during use.
- The display should be used only with European TN and TT power distribution systems.

It is not suitable for older, IT-type power distribution systems found in some European countries. "This system (IT-type) is widely used isolated from earth, in some installations in France, with impedance to earth, at 230/400V, and in Norway, with voltage limiter, neutral not distributed, at 230V line-to-line."

Contact qualified personnel if you're uncertain of the type of power system available where you're installing the display.
- The accessory slot's maximum available power is 60 W. The slot is not a limited power source. To reduce the risk of fire, make sure that accessories connecting to the slot satisfy the fire enclosure requirements of IEC 60950-1 and/or IEC 62368-1.
- You must connect the USB cable that came with the display to a computer that has a USB compliant interface and that bears the USB logo. In addition, the USB source computer must be compliant with IEC 60950-1 and/or IEC 62368-1. The source computer must be CE marked and carry safety certification marks for Canada and USA. This is for operating safety and to avoid damage to the display.

Important information

- Wait five minutes before removing the AM50 appliance from the display to allow the appliance to cool.

IMPORTANT

- The following are the normal operating power requirements for the display:

Models	Power requirements
SBID-7275R, SBID-7275R-P, SBID-7075R, and SBID-7075R-P	100V to 240V AC, 50 Hz to 60 Hz, 129 W
SBID-7286R, SBID-7286R-P, SBID-7086R, and SBID-7086R-P	100V to 240V AC, 50 Hz to 60 Hz, 169 W

- For additional requirements and other information, refer to the display's specifications (see *More information* on page 17).

ENERGY STAR®



ENERGY STAR is the government-backed symbol for energy efficiency, providing simple, credible, and unbiased information that consumers and businesses rely on to make well-informed decisions. ENERGY STAR-certified products are the simple choice for energy efficiency, making it

easy for consumers and businesses to make purchases that save them money and protect the environment. The U.S. EPA ensures that each product that earns the label is independently certified to deliver the quality, performance, and savings that users have come to expect.

As shipped, your display delivers ENERGY STAR performance and savings. However, changing some settings may increase energy consumption beyond the limits required for ENERGY STAR certification. For example, increased brightness and contrast will increase power consumption.

Please consider the environment when you choose non-ENERGY STAR settings.

Federal Communication Commission interference statement

FCC

Supplier's Declaration of Conformity

47 CFR § 2.1077 Compliance Information

Unique Identifier: IDR775-1, IDR786-1, IDRMOD1, PR7-1

Responsible Party – U.S. Contact Information

SMART Technologies Inc.
2401 4th Ave., 3rd Floor
Seattle, WA 98121

compliance@smarttech.com

The FCC and ISED registration numbers and warnings can be found through the *Settings* screen under the *Regulatory* tab.

Regulatory Model: IDR775-1

Regulatory Model: IDR786-1

Regulatory Model: PR7-1

This device complies with Part 15 of the FCC Rules. Operation is subject to the following two conditions:

1. This device may not cause harmful interference, and
2. this device must accept any interference received, including interference that may cause undesired operation.

CAUTION

Changes or modifications not expressly approved by the party responsible for compliance could void the user's authority to operate the equipment.

NOTE

This equipment has been tested and found to comply with the limits for a Class A digital device, pursuant to part 15 of the FCC Rules. These limits are designed to provide reasonable protection against harmful interference when the equipment is operated in a commercial environment. This equipment generates, uses, and can radiate radio frequency energy and, if not installed and used in accordance with the instruction manual, may cause harmful interference to radio communications. Operation of this equipment in a residential area is likely to cause harmful interference in which case the user will be required to correct the interference at his own expense.

Regulatory Model: IDRMOD1

This device complies with Part 15 of the FCC Rules. Operation is subject to the following two conditions:

1. This device may not cause harmful interference, and
2. this device must accept any interference received, including interference that may cause undesired operation

CAUTION

Changes or modifications not expressly approved by the party responsible for compliance could void the user's authority to operate the equipment.

Important information

NOTE

This equipment has been tested and found to comply with the limits for a Class A digital device, pursuant to part 15 of the FCC Rules. These limits are designed to provide reasonable protection against harmful interference when the equipment is operated in a commercial environment. This equipment generates, uses, and can radiate radio frequency energy and, if not installed and used in accordance with the instruction manual, may cause harmful interference to radio communications. Operation of this equipment in a residential area is likely to cause harmful interference in which case the user will be required to correct the interference at his own expense.

Restriction

This device is restricted to indoor use when operated in the 5.15 to 5.25 GHz frequency range.

IEEE 802.11b or 802.11g operation of this product in the USA is firmware limited to channels 1 through 13.

Radiation exposure statement

This equipment complies with FCC radiation exposure limits set forth for an uncontrolled environment. This equipment should be installed and operated with minimum distance 20 cm between the radiator and your body. The PEN can be used with 0 cm separation distance between the pen and your body.

Innovation, Science and Economic Development Canada statement

The FCC and ISED registration numbers and warnings can be found through the *Settings* screen under the *Regulatory* tab.

Regulatory Model: IDR775-1

Regulatory Model: IDR786-1

This device complies with ICES-003 of the Innovation, Science and Economic Development Canada Rules. Operation is subject to the following two conditions:

1. This device may not cause harmful interference, and
2. this device must accept any interference received, including interference that may cause undesired operation.

Regulatory Model: PR7-1

This device complies with Industry Canada's RSS-310. Operation is subject to the condition that this device must not cause harmful interference and must accept any interference, including interference that may cause undesired operation of the device.

98-305kHz: <30dBuV/A @10m

Regulatory Model: IDRM01

This device complies with ICES-003 of the Innovation, Science and Economic Development Canada Rules. Operation is subject to the following two conditions:

1. This device may not cause harmful interference, and
2. this device must accept any interference received, including interference that may cause undesired operation.

CAUTION

(i) the device for operation in the band 5150–5250 MHz is only for indoor use to reduce the potential for harmful interference to co-channel mobile satellite systems;

(ii) the maximum antenna gain permitted for devices in the bands 5250–5350 MHz and 5470–5725 MHz shall comply with the e.i.r.p. limit; and

(iii) the maximum antenna gain permitted for devices in the band 5725–5825 MHz shall comply with the e.i.r.p. limits specified for point-to-point and non point-to-point operation as appropriate.

(iv) Users should also be advised that high-power radars are allocated as primary users (i.e., priority users) of the bands 5250–5350 MHz and 5650–5850 MHz and that these radars could cause interference and/or damage to LE-LAN devices.

Radiation exposure statement

This equipment complies with ISED radiation exposure limits set forth for an uncontrolled environment. This equipment should be installed and operated with minimum distance 20 cm between the radiator and your body. The PEN can be used with 0 cm separation distance between the pen and your body.

Innovation, Science et Développement économique Déclaration du Canada

AVERTISSEMENT

(i) les dispositifs fonctionnant dans la bande 5 150–5 250 MHz sont réservés uniquement pour une utilisation à l'intérieur afin de réduire les risques de brouillage préjudiciable aux systèmes de satellites mobiles utilisant les mêmes canaux;

(ii) le gain maximal d'antenne permis pour les dispositifs utilisant les bandes 5 250–5 350 MHz et 5 470–5 725 MHz doit se conformer à la limite de p.i.r.e.;

(iii) le gain maximal d'antenne permis (pour les dispositifs utilisant la bande 5 725–5 825 MHz) doit se conformer à la limite de p.i.r.e. spécifiée pour l'exploitation point à point et non point à point, selon le cas.

(iv) De plus, les utilisateurs devraient aussi être avisés que les utilisateurs de radars de haute puissance sont désignés utilisateurs principaux (c.-à-d., qu'ils ont la priorité) pour les bandes 5 250–5 350 MHz et 5 650–5 850 MHz et que ces radars pourraient causer du brouillage et/ou des dommages aux dispositifs LAN-EL.

Important information

Déclaration d'exposition aux radiations

Cet équipement est conforme aux limites d'exposition aux rayonnements IC établies pour un environnement non contrôlé. Cet équipement doit être installé et utilisé avec un minimum de 20 cm de distance entre la source de rayonnement et votre corps. Le PEN peut être utilisé avec une distance de séparation de 0 cm entre le stylo et votre corps.

EU declaration of conformity

Hereby, SMART Technologies ULC declares that the radio equipment type Interactive WiFi Module IDRMOD-1 and the interactive pen PR7-1 are in compliance with Directive 2014/53/EU. The full text of the EU declaration of conformity is available at the following internet address:

smarttech.com/compliance

The frequency band and the maximum transmitted power in EU are listed below:

PR7-1

98-305kHz: <30dBuV/A @10m

IDRMOD1

2400MHz – 2480MHz: 19dBm (EIRP) 5150MHz – 5850MHz: 13dBm (EIRP)

Restrictions in

BE/BG/CZ/DK/DE/EE/IE/EL/ES/FR/HR/IT/CY/LV/LT/LU/HU/MT/NL/AT/PL/PT/RO/SI/SK/FI/SE/UK/TR/NO/CH/IS/LI. 5150MHz-5350MHz is for indoor use only.



CAUTION: EXPOSURE TO RADIO FREQUENCY RADIATION

This equipment complies with EU radiation exposure limits set forth for an uncontrolled environment. This equipment should be installed and operated with minimum distance 20 cm between the radiator and your body. The PEN can be used with 0 cm separation distance between the pen and your body.

For optimal performance any support equipment connected to this device must be CE compliant

Microsoft® statement regarding Windows® 10 operating system

Windows 10 is automatically updated, which is always enabled. ISP fees may apply. Additional requirements may apply over time for updates.

Contents

- Important information 3**
- Chapter 1: Welcome 9**
 - About this guide 9
 - About the display10
 - Identifying your specific model 15
 - Accessories 15
 - More information 17
- Chapter 2: Installing the display 18**
 - Moving the display to the installation site18
 - Installing the display on a wall 20
 - Installing the display on a stand 24
 - Connecting to a network 25
 - Connecting power and turning on the display for the first time 26
 - Pairing pens with the display 28
- Chapter 3: Connecting computers and other devices 29**
 - Installing SMART software 30
 - Connecting room computers and guest laptops 31
 - Connecting a SMART OPS PC module 37
 - Connecting other devices 38
 - Connector diagrams 43
- Chapter 4: Maintaining the display 48**
 - Turning off, turning on, and resetting the display 48
 - Cleaning and maintaining hardware 49
 - Updating system software 52
- Chapter 5: Troubleshooting 54**
 - The display isn't turning on 54
 - The display is turning on when it shouldn't 55
 - The screen is blank or there's a problem with the image on the screen 55
 - There's no sound or there's a problem with the sound 57
 - Touch isn't working as expected 57
 - The pens and erasers aren't working as expected 58
 - iQ apps aren't working as expected 59
 - SMART software on connected computers isn't working as expected 59
 - The SMART OPS PC module isn't working as expected 60

Contents

Contacting your reseller for additional support	60
Appendix A: Adjusting settings	62
Network settings	62
Personalization	63
Application settings	64
System settings	66
Appendix B: Managing the display using RS-232	71
Configuring the computer's serial interface settings	72
Power states	73
Commands and responses	73
Power state commands	75
Input commands	76
Brightness commands	76
Freeze commands	76
Screen shade commands	77
Volume commands	77
Mute commands	77
Firmware version commands	77
Serial number commands	78
Part number commands	78
Asynchronous state reporting commands	78
Factory reset commands	78
Resolving issues with managing the display using RS-232	79
Appendix C: Hardware environmental compliance	80
Waste Electrical and Electronic Equipment (WEEE)	80
Batteries	80
More information	80

Chapter 1

Welcome

About this guide	9
About the display	10
Touch	10
Writing, drawing, and erasing	11
iQ experience	11
Display	11
Audio	12
Network connectivity	12
Room computers and guest laptops	12
Accessory slot	12
Convenience panel	13
Proximity sensors	13
Ambient light sensor	14
Remote control and IR sensor	14
Mounting hardware	14
Identifying your specific model	15
Accessories	15
SMART OPS PC module	16
SBA-100 projection audio system	16
Stands	16
USB extenders	16
More information	17

This chapter introduces the SMART Board® 7000R and 7000R Pro series interactive displays.

About this guide

This guide explains how to install and maintain a SMART Board 7000R or 7000R Pro series interactive display. It includes the following information:

- How to install the display
- How to connect power and devices
- How to turn on the display for the first time and configure the iQ experience

- How to maintain the display for years of use
- How to troubleshoot issues with the display

In addition, this guide includes information about the display's settings and remote management support.

This guide is intended for those who install and maintain displays in their organizations. Other documentation and resources are available for those who use displays (see *More information* on page 17).

About the display

The SMART Board 7000R or 7000R Pro series interactive display is a powerful but easy-to-use collaboration tool that you can use to achieve better outcomes.

The display includes an extensive set of features and components.

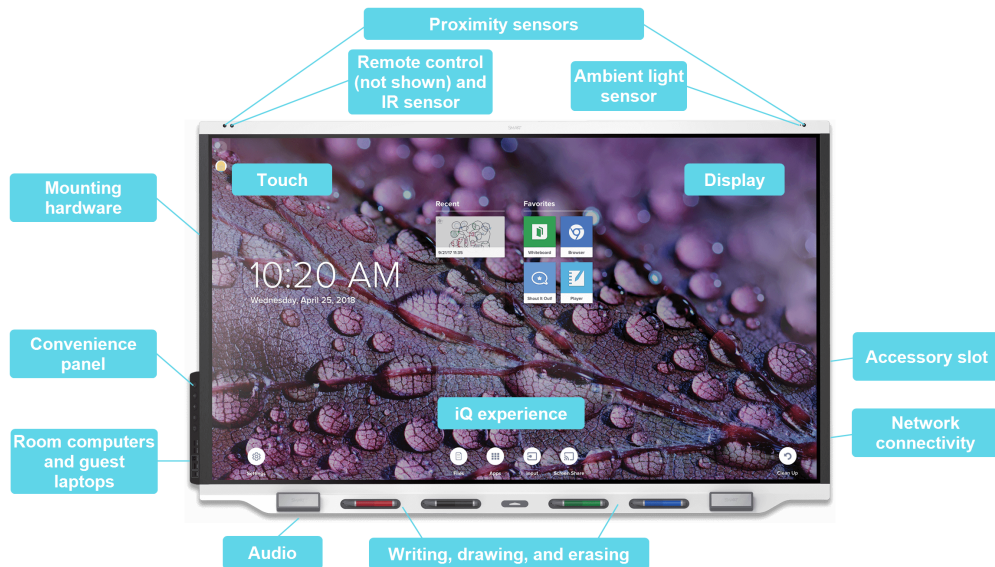

Touch

You can do everything on the display that you can do at your computer—open and close applications, meet with others, create new documents or edit existing ones, visit websites, play and manipulate videos, and so on—by touching the display's surface.

You can use an array of gestures within applications, including panning, scaling, rotating, and zooming in and out.

The display's HyPr Touch™ with EMR technology provides industry-leading touch and digital ink performance, resulting in virtually no lag and zero contact detect height. In addition, its Silktouch™ ultra-smooth finish allows you to use the display for hours without finger burn.

Writing, drawing, and erasing

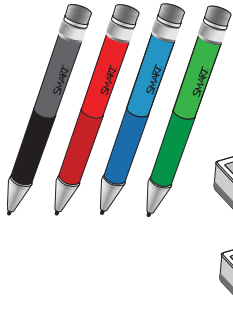

The display comes with black, red, blue, and green pens, which you can use to write or draw on the screen.

In addition to the pens, the display includes two erasers, which you can use to erase digital ink on the screen.

With Object Awareness™, the display responds automatically to the tool or object you're using, whether it's a pen, finger, eraser, or palm. The display's Pen ID™ and Simultaneous Tool Differentiation technologies allow four people to write independently and simultaneously, using

different colored ink.

iQ experience

If enabled, the iQ embedded computer provides one-touch access to collaborative tools, such as a whiteboard, wireless screen sharing, and a web browser. There's no need for wires, cables, or manual software and firmware updates.

NOTE

Some network integration is required for features like Browser and Screen Share.

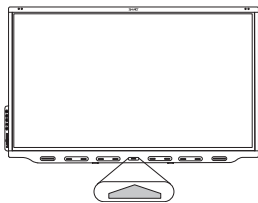

Tap the **Home** button on the display (pictured) or the remote control to open the Home screen (if iQ is enabled) or the Input screen (if iQ is disabled). From the Home screen, you can open the iQ apps, switch inputs, and adjust settings.

Display

The 4K ultra-high-definition LED display provides optimal image clarity and wide viewing angles.

The size of the display varies by model:

Models	Size (diagonal)
SBID-7275R, SBID-7275R-P, SBID-7075R, and SBID-7075R-P	75"
SBID-7286R, SBID-7286R-P, SBID-7086R, and SBID-7086R-P	86"

Audio

The display includes two 15 W integrated speakers, which are designed to provide sound at the front of a room.

TIP

You might want to connect an external audio system if you're providing sound in a larger space (see *Connecting an external audio system* on page 41).

Network connectivity

The display requires a network connection for downloading software and firmware updates, and a number of the iQ apps require a network connection as well.

You can connect to a network using the Wi-Fi module or the LAN RJ45 jack on the display:

- The Wi-Fi module supports both 2.4 and 5 GHz bands.
- The two RJ45 jacks allow you to connect the display and an external device, such as a computer, to a Gigabit Ethernet network.

For more information, see *Connecting to a network* on page 25.

Room computers and guest laptops

You can connect room computers and guest laptops and use the display to view and interact with them.

The display comes with SMART software that you can install on connected computers to take full advantage of the display's features while using the connected computers.

For more information, see *Chapter 3: Connecting computers and other devices* on page 29.

Accessory slot

You can install an OPS-compatible device, such as a SMART OPS PC module, in the accessory slot. The PCM8 series of SMART OPS PC modules provides a complete Windows 10 Pro installation.

For more information about the PCM8 series of SMART OPS PC modules, see *SMART OPS PC module* on page 16.

CAUTION

- The accessory slot's maximum available power is 60 W. The slot is not a limited power source. To reduce the risk of fire, make sure that accessories connecting to the slot satisfy the fire enclosure requirements of IEC 60950-1 and/or IEC 62368-1.
 - Do not remove the OPS PC module or other devices from the accessory slot while they are turned on.
-

NOTE

Unlike with older SMART Board interactive displays, you don't need to install an AM30, AM40, or AM50 appliance in the accessory slot to use the iQ experience on SMART Board 7000R and 7000R series displays. The iQ experience is embedded on these displays (see *iQ experience* on page 11). For this reason, SMART doesn't recommend installing AM30, AM40, or AM50 appliances in these displays' accessory slots.

Convenience panel

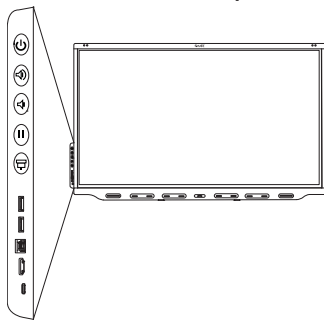

The convenience panel contains buttons for turning the display on and off, controlling the volume, freezing and unfreezing the screen, and showing and hiding a screen shade. It also includes connectors for USB peripherals and a computer or other input source.

Proximity sensors

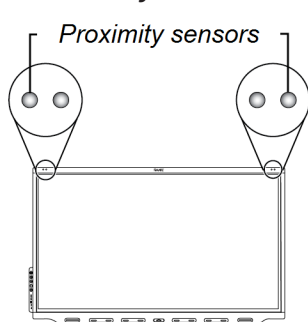

The proximity sensors are located in the top-left and top-right corners of the display's frame.

The proximity sensors can detect people up to 16' (5 m) away when the display is in Standby mode.

When the proximity sensors detect people in the room, the display either turns on or is ready to turn on, depending on how it's configured.

If the room is empty for 60 minutes, the display returns to Standby mode.

NOTE

The sensors can detect people through glass. Consider this when finding a location for the display (see *Choosing a location* on page 21). Don't position the display so that the sensors are facing a window.

Ambient light sensor

Ambient light sensor

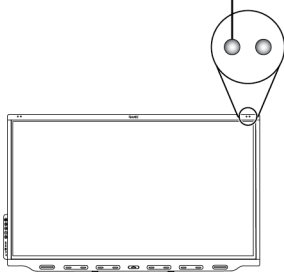

The ambient light sensor is located in the top-right corner of the display's frame.

The ambient light sensor detects the brightness of the room and adjusts the screen's brightness accordingly.

Remote control and IR sensor

IR sensor

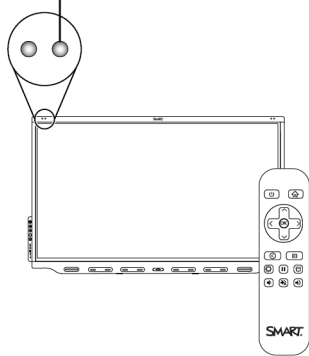

You can use the remote control to turn the display on and off, adjust display settings, and so on.

The IR sensor for the remote control is located in the top-left corner of the display's frame.

Mounting hardware

The display comes with a WM-SBID-200 wall mount, which you can use to mount the display on a wall (see *Installing the display on a wall* on page 20).

Alternatively, you can mount the display on a wall or mobile stand (see *Accessories* on the next page).

Identifying your specific model

SMART offers different models of the SMART Board 7000R and 7000R Pro series interactive display:

Model	Frame style	Screen size (approximate)	iQ
SBID-7275R	White	75"	Yes
SBID-7286R	White	86"	Yes
SBID-7275R-P	Black	75"	Yes
SBID-7275R-PW	White	75"	Yes
SBID-7286R-P	Black	86"	Yes
SBID-7286R-PW	White	86"	Yes
SBID-7075R	White	75"	No
SBID-7086R	White	86"	No
SBID-7075R-P	Black	75"	No
SBID-7075R-PW	White	75"	No
SBID-7086R-P	Black	86"	No
SBID-7086R-PW	White	86"	No

Refer to the specifications for detailed technical information for these models, including product dimensions and weights (see *More information* on page 17).

Accessories

Accessories for the display include:

- SMART OPS PC module
- SBA-100 projection audio system
- Stands
- USB extenders

NOTE

For more information about these and other accessories, see smarttech.com/accessories.

SMART OPS PC module

SMART Open Pluggable Specification (OPS) PC modules provide a hassle-free Windows® 10 Pro installation based on eighth generation Intel® Core™ processors and are designed specifically to work with a SMART display. Available in two standard configurations, all OPS PC modules in the PCM8 series are WHQL certified and fully licensed with Windows 10 Pro. Install the OPS PC module in a display's OPS slot to provide a complete 4K UHD Windows 10 installation at your fingertips, without the need for an external PC or additional cables.

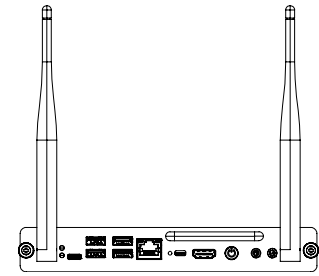

Install familiar Windows applications, such as SMART Notebook®, SMART TeamWorks™, and SMART Meeting Pro® software, and access the internet directly through your display's network connection. Upgrades and service for the OPS PC module are easy to perform without removing the display from its mounting.

SBA-100 projection audio system

For education models only

The SBA-100 projection audio system consists of two 14 W speakers designed for wall-mounted displays. You can control volume using the display's convenience panel or the volume controls on a connected computer.

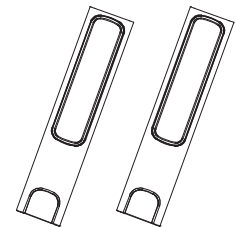

Stands

If you want to move the display from place to place, you can install it on a SMART mobile stand. If you are installing the display on a wall that cannot support the display's full weight, you can install the display on a SMART floor stand.

USB extenders

As noted in *Using recommended cables* on page 36, the [USB connection](#) between the display and computer should be no longer than 16' (5 m). If you need to connect a computer that is more than 16' (5 m) from the display, use the USB-XT extender (smarttech.com/kb/119318).

NOTE

For more information about extending USB connections, see [USB cable extenders](#).

More information

In addition to this guide, SMART provides other documents for the display in the Support section of the SMART website (smarttech.com/support). Scan the QR code on the cover of this guide to view links to SMART Board 7000R and 7000R Pro series interactive display documents and other support resources.

Chapter 2

Installing the display

Moving the display to the installation site	18
Using transportation aides	19
Accommodating doorways, hallways and elevators	19
Dealing with cracked, chipped or shattered glass	20
Saving the original packaging	20
Installing the display on a wall	20
Choosing a location	21
Choosing a height	23
Assessing the wall	23
Selecting mounting hardware	23
Selecting a wall mount	23
Mounting the display	24
Installing the display on a stand	24
Using SMART mobile stands	25
Using a third-party stand	25
Connecting to a network	25
Connecting power and turning on the display for the first time	26
Pairing pens with the display	28

SMART recommends that only trained installers install the display.

This chapter is for installers. Installers should read this information along with the installation instructions included with the display before they begin the installation.

WARNING

Improper installation of the display can result in injury and product damage.

Moving the display to the installation site

After your organization receives the display, you need to move it to the place where you plan to install it.

On occasion, you might also need to move the display to another location after initially installing it.

! **IMPORTANT**

- Move the display at your own risk. SMART cannot accept liability for damages or injury that occur during the display's transportation.
 - When moving the display
 - Follow local safety regulations and standards.
 - Pack the display in its original packaging, including the pallet.
 - Move the display so that its top frame faces up.
 - Have at least two people move the display.
-

TIP

Display packaging may be labeled to indicate which side is the front. Look for "FRONT" on the packaging to help orient the box during transportation.

Using transportation aides

You can use the following aides to move the display:

- Cart
- Furniture dolly
- Mechanical lift

Accommodating doorways, hallways and elevators

In some situations, you might need to remove the display from its packaging to move it through narrow doorways or hallways or on to an elevator. In these situations, keep the foam pieces on the bottom corners of the display. These foam pieces protect the display if you need to set it down during transportation.

You might also need to rotate the display so that its top frame faces to the side. You can do this during transportation, but when you install the display, it must be in landscape orientation (with the top frame facing up).

Dealing with cracked, chipped or shattered glass

The display contains safety-tempered glass. Although this glass is heat-strengthened to help withstand impacts, the glass can crack, chip or shatter if struck with enough force. (Safety glass is designed to break into small pieces rather than sharp shards if it is broken.) Temperature changes can cause a minor crack or chip to become worse, possibly causing the glass to shatter. See the knowledge base article, [Shattered glass on an interactive display](#), for information about conditions that can cause the display's glass to shatter even when it's not in use.

If the display's glass is cracked or chipped, have it professionally inspected and repaired at a SMART authorized repair center. If the display's glass shatters, carefully clean up the area and have the display repaired or replaced.

CAUTION

For safety and to prevent further damage, do not continue to install or use the display if its glass is cracked, chipped or shattered.

Saving the original packaging

Save the original packaging and repack the display with as much of it as possible if you ever need to move the display after installation. This packaging was designed to provide the best possible protection against shock and vibration.

CAUTION

Move the display only in the original packaging or replacement packaging purchased from your authorized SMART reseller. Moving the display without correct packaging can lead to product damage and voids the warranty.

NOTE

If the original packaging isn't available, you can purchase the same packaging directly from your authorized SMART reseller (smarttech.com/where).

Installing the display on a wall

Typically, you install the display on a wall in a classroom or meeting space.

Choosing a location

A display is typically installed at the room's focal point, such as at the front of a classroom or meeting space.

Selecting an appropriate location for the display is crucial for ensuring the best possible experience with the product. Consider the following factors as you choose a location:

Factor	Considerations
Room setup	<ul style="list-style-type: none">• The location allows users, including those in wheelchairs, access to the display. Refer to local regulations regarding accessibility.• The location allows for multiple users to access the display at the same time.• The location accommodates room traffic patterns, and there are no tripping hazards.• The display is not installed where it could be hit by a door or gate.• There are no nearby heat sources directed at the display such as a radiator or heat vent.• There are no nearby shelving units, desks, or other furniture that has doors or drawers that could hit the display.• Furniture, wall décor, and other room features, such as light switches and thermostats, do not block the display and are not blocked by it. (You might be able to move some of these room features to accommodate the display.)
Power and other connections	<ul style="list-style-type: none">• The location is close to:<ul style="list-style-type: none">◦ A power outlet◦ A network outlet (if you plan to use a wired network connection)◦ A room computer (if you plan to connect a room computer)◦ External audio systems and other devices that you want to connect to the display <hr/> <p>NOTES</p> <ul style="list-style-type: none">◦ If the location is not near a power outlet, consult an electrician for the power setup you need.◦ Determine if you'll need additional equipment, such as power bars, additional cables, or cable extenders. <hr/> <ul style="list-style-type: none">• The location is not where the mains power supply enters the building.

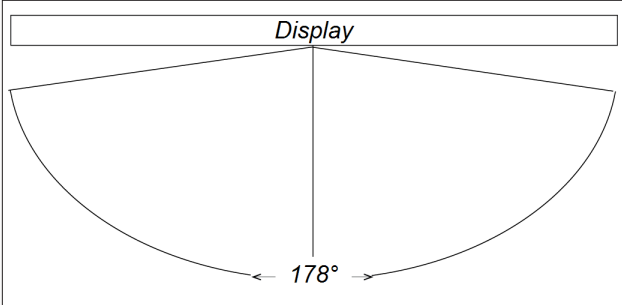
Factor	Considerations
<p>Visibility</p>	<p>The display's screen is clearly visible to all users in the room. SMART recommends users sit within a 178° viewing area:</p>  <p>NOTE</p> <p>The viewing area depends on the display's resolution and a variety of other factors. For more information, see the knowledge base article, Recommended viewing distances and viewing angles for SMART Board interactive flat panels.</p>
<p>Lighting</p>	<p>The location is not near bright light sources, such as windows or strong overhead lighting.</p> <p>Light sources can cause glare on the display's screen, reducing its visibility.</p> <p>TIP</p> <p>To reduce light interference, install blinds or shades on windows or skylights and install switches to dim or turn off any lights shining directly on the display's screen. Keep in mind that sunlight can come through windows at different angles at different times of the year.</p>
<p>Acoustics</p>	<p>The room has good acoustics (see Configuring your SMART Board 7000R or 7000R Pro for the best audio performance).</p>
<p>Environment and ventilation</p>	<ul style="list-style-type: none"> • The location meets the environmental requirements in the display's specifications (see <i>More information</i> on page 17). • The display isn't subjected to strong vibrations or dust. • Ventilation systems don't blow air directly on the display. • There is adequate ventilation or air conditioning around the display so that heat can flow away from it and the mounting equipment. SMART recommends at least 2" (5 cm) of space on all sides of the display for proper airflow. • If you plan to install the display in a recessed area, there is at least 4" (10 cm) of space between the display and the recessed walls to enable ventilation and cooling.

Choosing a height

Consider the general height of the user community when you choose the height for the display.

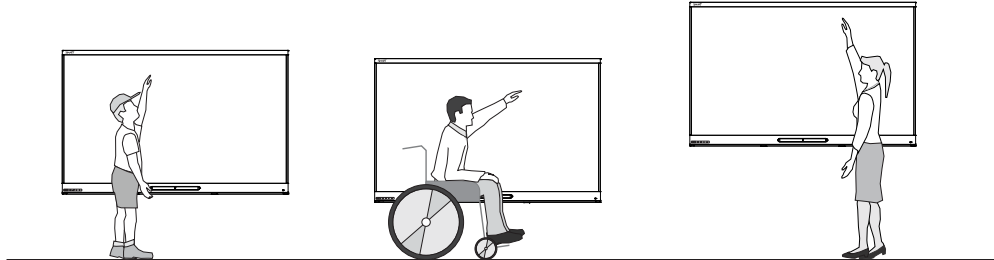

SMART recommends that you mount the display so that its top is 6' 5" (1.9 m) from the floor.

NOTE

If participants will be sitting at a steep angle (such as in a lecture hall), you may have to adjust the installation height or angle.

Assessing the wall

Be sure the wall you're installing the display on can support the weight of the display and mounting equipment. If it can't, consider using a SMART wall stand to transfer some of the weight from the wall to the floor (see [smarttech.com/accessories](https://www.smarttech.com/accessories)).

NOTE

Refer to the display's specifications for its weight (see *More information* on page 17).

In some situations, you may need to request an engineering analysis to determine if the wall can support the display.

Selecting mounting hardware

The mounting hardware required for installation varies according to the type of wall onto which the display is being mounted.

Refer to *Installation best practices for SMART products* ([smarttech.com/kb/171035](https://www.smarttech.com/kb/171035)) for the mounting hardware required for the display.

Selecting a wall mount

It is always best to mount the display on a wall. If the wall can't support the display's weight, you can use additional hardware to transfer some of the weight to the floor.

The display comes with a WM-SBID-200 wall mount. SMART recommends using this wall mount to install the display on a wall.

If you choose a third-party option rather than one of SMART's mounting options, be sure the wall mount can accommodate the display's dimensions and support the display's weight as well as the weight of any attached accessories.

Mounting the display

Mount the display following the included installation instructions. In addition, consider the following:

- Mount the display vertically (90° relative to the floor plus or minus 2° for tolerance) and in landscape orientation. SMART doesn't support mounting the display at other angles or in portrait orientation.

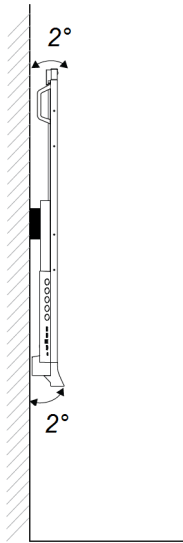

- Use the M8 bolts included with the wall mount to fasten the bracket.

CAUTION

Do not over-tighten the bolts. Use 97.36–177.01 in-lb. (11–20 N·m) fasten force.

- Because the receptacles might not be easily accessible after you mount the display, consider connecting cables for power, room computer and other devices while the display is still in its packaging (see *Chapter 3: Connecting computers and other devices* on page 29).

Installing the display on a stand

If you want to move the display from place to place or if it's not possible to install the display on a wall, you can install it on a stand.

Using SMART mobile stands

SMART mobile stands are designed for SMART interactive displays. They are height-adjustable. Some models include integrated speakers, a locking cabinet to secure equipment, and casters that swivel and lock for easy movement.

For more information about SMART mobile stands, see smarttech.com/accessories.

Using a third-party stand

For information about selecting and using a third-party stand, see [Installing your SMART Board 7000R or 7000R Pro on a stand](#).

Connecting to a network

The display requires a network connection for downloading software and firmware updates, and a number of the iQ apps, including Browser and Screen Share, require a network connection as well. You can connect to a network using the Wi-Fi module or the **LAN** RJ45 jack on the connector panel.

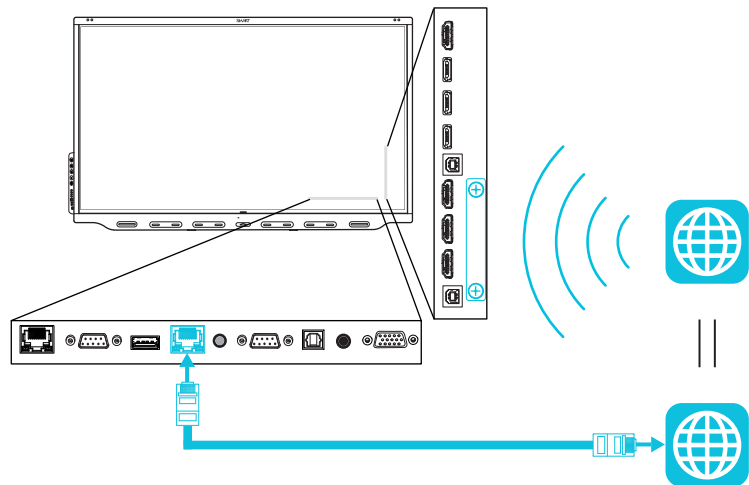

! IMPORTANT

- Use the RJ45 jack labeled **LAN** (pictured above) and not the other RJ45 jack on the connector panel.
- If installed in the accessory slot, the OPS PC module shares the display's network connection. You do not need to connect a network cable to the OPS PC module's RJ45 jack or configure its Wi-Fi separately from the display's Wi-Fi.

TIP

If you're using the display's **LAN** RJ45 jack to connect to a network, you can connect the other RJ45 jack to a computer to provide network access for the computer. This is particularly useful if there is only one wired network connection in the room. (Network access is available when the display is on or in Standby mode but not when it's in Power Save mode.)

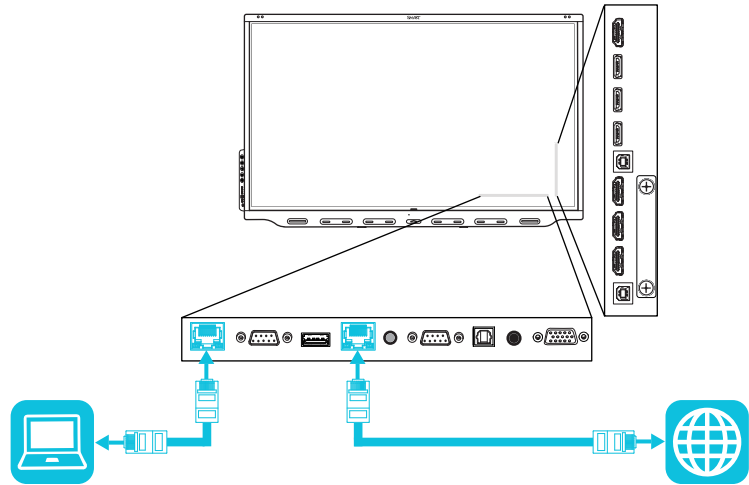

You'll also need to work with your organization's network administrators to configure the network for the display, see [Connecting a SMART display with the iQ experience to a network](#).

Connecting power and turning on the display for the first time

The final step in installing and configuring the display is to connect power and turn it on. When you first turn on the display, a setup wizard appears. Follow the steps in the wizard to complete the setup.

To connect the display to power

Connect the supplied power cable from the AC power inlet on the back of the display to a power outlet.

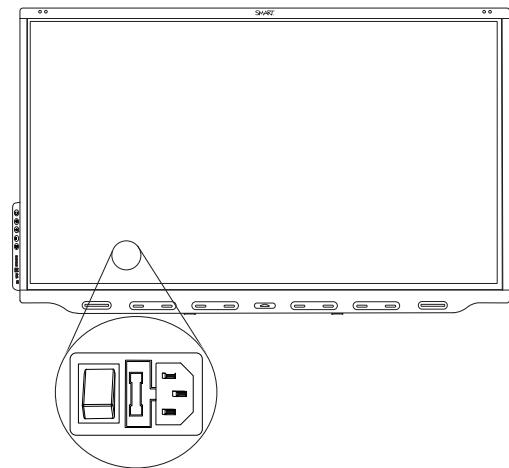

NOTE

Refer to the display's specifications for power requirements and power consumption information (see *More information* on page 17).

To turn on and set up the display for the first time

 **IMPORTANT**

Install the OPS PC module before you turn the display on.

NOTE

If a USB drive is connected to the display's service port, do not remove the USB drive. The USB drive contains an important firmware update.

1. Flick the switch beside the AC power inlet to the ON (I) position.
2. Press the **Power** button  on the front control panel or remote control
3. Select your preferred language, and then tap **Next**.
4. Select your country, and then tap **Next**.
5. Select your time zone, and then tap **Next**.
6. Set the date, and then tap **Next**.
7. Set the time, and then tap **Next**.
8. Name the display, and then tap **Next**.
9. If the display isn't using a wired network connection, select a wireless network, and then tap **Next**.

 **IMPORTANT**

The display needs an internet connection for downloading and installing important updates. Ask the network administrator to confirm that the network has been correctly configured for the iQ experience. For more information about network configuration, see [Connecting a SMART display with the iQ experience to a network](#).

10. Select the apps you want to appear in the Apps Library, and then tap **Next**.

TIP

To change which apps appear in the Apps Library, see *Launcher* on page 64.

11. Tap **Finish**.

The *Welcome* screen appears.

Pairing pens with the display

After you install the display and turn it on for the first time, place the pens in the holders for at least five minutes. This pairs the pens with the display and charges them for testing purposes.

IMPORTANT

- Use only pens designed for SMART Board 7000R and 7000R Pro series interactive displays. Pens for other SMART products, including SMART Board 7000 and 7000 Pro series interactive displays, aren't compatible with SMART Board 7000R and 7000R Pro series interactive displays (see smarttech.com/kb/171230).
 - If you previously paired a pen with a SMART Board 7000R or 7000R Pro series interactive display, you must pair it with another display to use it with that display.
 - To fully charge the pens, keep them in the holders for at least four hours before you start using the display.
-

Chapter 3

Connecting computers and other devices

Installing SMART software	30
Connecting room computers and guest laptops	31
Viewing a connected computer's input	34
Setting a connected computer's resolution and refresh rate	35
Using recommended cables	36
Sharing USB Type-B receptacles	36
Connecting a SMART OPS PC module	37
Viewing the OPS PC module input	38
Connecting external displays	38
Connecting other devices	38
Connecting USB drives, peripherals, and other devices	38
Connecting an external display	40
Connecting an external audio system	41
Connecting room control systems	42
Connector diagrams	43
Connector panel	43
Convenience panel	45
SMART OPS PC module (optional)	46

WARNING

Ensure that any cables that cross the floor to the display are properly bundled and marked to avoid a trip hazard.

Installing SMART software

The display comes with the following software, which you can install on connected computers:

Software	Description	Notes
SMART Learning Suite	A suite of desktop and online software that combines lesson delivery, activities, assessments, and collaborative workspaces. Includes SMART Notebook software and SMART Learning Suite Online.	Education models only. SMART Notebook basic version also available.
SMART TeamWorks room edition	Software that simplifies meetings and facilitates deeper, more natural interaction with on-site and remote participants.	Pro models only.
SMART Meeting Pro	Software that enables you to capture ideas in a virtually unlimited interactive workspace.	Pro models only.
SMART Product Drivers	Software that enables the computer to detect input from the display.	Included with SMART Learning Suite, SMART TeamWorks, and SMART Meeting Pro software
SMART Ink	Software that enables you to write and draw in digital ink over applications, files, folders, websites, and any other open window.	Included with SMART Learning Suite, SMART TeamWorks, and SMART Meeting Pro software
SMART Remote Management	Cloud-based mobile device management software for remotely maintaining, supporting, controlling, and securing the display and your other devices.	N/A

TIP

You can purchase additional licenses or subscriptions to SMART software to install on other computers.

Contact your authorized SMART reseller (smarttech.com/where) for information about purchasing SMART software.

You can download SMART software from smarttech.com/downloads and install it following the instructions in [Installing and maintaining SMART Notebook](#), [Downloading and installing SMART TeamWorks](#), or [Installing and maintaining SMART Meeting Pro](#).

Connecting room computers and guest laptops

You can connect cables for room computers and guest laptops. By installing cables in advance, you make use of connectors that might not be accessible after the display is wall-mounted. You can then run the cables across floors or behind walls as needed.

NOTES

- Install SMART software on any computers you connect to the display (see *Installing SMART software* on the previous page).
- As shown below, HDMI 1 and HDMI 2 share the Touch 1 USB Type-B receptacle, and HDMI 3 and VGA share the Touch 2 USB Type-B receptacle (see *Sharing USB Type-B receptacles* on page 36).
- You can charge devices connected to the USB Type-C receptacle up to 60 W.

The following are the locations of the connectors and the connector and cable information for the display's input sources:

- USB Type-C

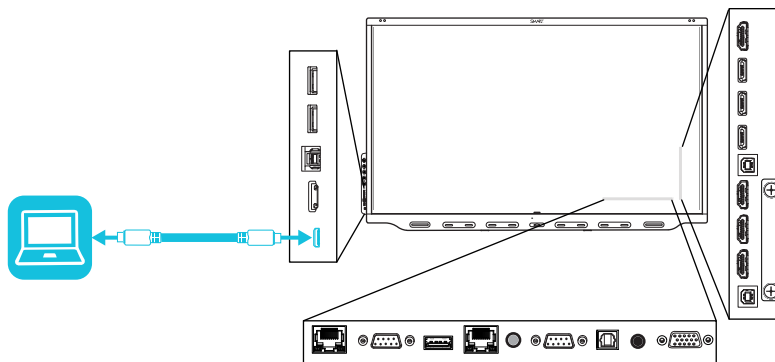

Connector	Standard	Connection type	Cable
USB Type-C	USB 3.1	Video/audio/touch	USB Type-C

- HDMI 1

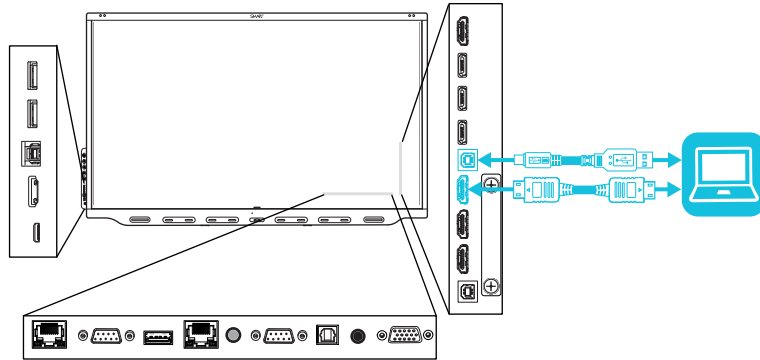

Connector	Standard	Connection type	Cable
HDMI 1	HDMI 2.0	Video/audio	HDMI
Touch 1 (USB Type-B)	Up to USB 3.0	Touch	USB 2.0/USB 3.0

- HDMI 2

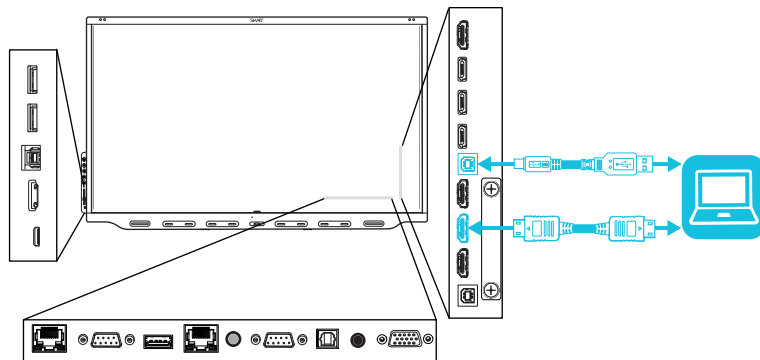

Connector	Standard	Connection type	Cable
HDMI 2	HDMI 2.0	Video/audio	HDMI
Touch 1 (USB Type-B)	Up to USB 3.0	Touch	USB 2.0/USB 3.0

- HDMI 3

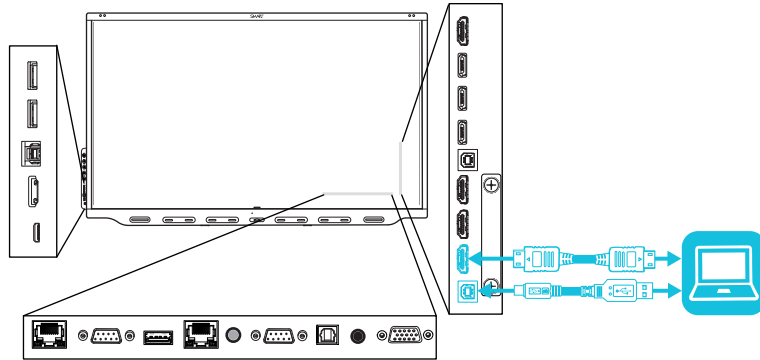

Connector	Standard	Connection type	Cable
HDMI 3	HDMI 2.0	Video/audio	HDMI
Touch 2 (USB Type-B)	Up to USB 3.0	Touch	USB 2.0/USB 3.0

- HDMI 4

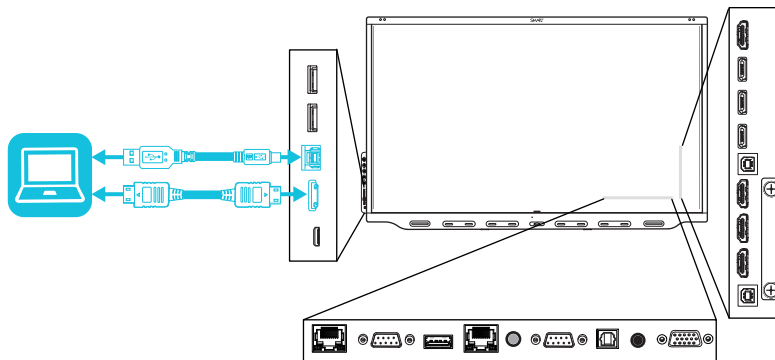

Connector	Standard	Connection type	Cable
HDMI 4	HDMI 2.0	Video/audio	HDMI
Convenience panel USB Type-B	Up to USB 3.0	Touch	USB 2.0/USB 3.0

- VGA

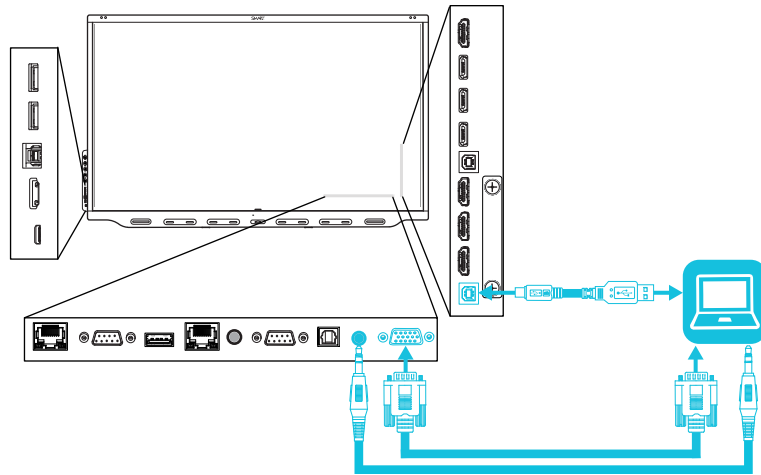







Connector	Standard	Connection type	Cable
VGA	VGA	Video	VGA
Audio In (Stereo 3.5 mm)	Stereo 3.5 mm	Audio	Stereo 3.5 mm
Touch 2 (USB Type-B)	Up to USB 3.0	Touch	USB 2.0/USB 3.0

Viewing a connected computer's input

Use the Input app to view a connected computer's input on the display.

To view a connected computer's input

1. Connect the computer to the display.
2. Do one of the following:

If iQ is enabled	If iQ is disabled
Tap the Home button  below the screen, and then tap Input  .	Tap the Home button  below the screen.
OR	OR
Press the Input button  on the remote control.	Press the Home button  or the Input button  on the remote control.

The display shows thumbnails of the devices that are connected to the display's inputs:

- A gray thumbnail indicates no device is connected to an input.
- A blue thumbnail indicates a device is connected to an input but is in Sleep mode.
- A thumbnail showing a preview screen indicates an active device is connected to an input.

TIP

If iQ is disabled and you want a computer's input to appear whenever you wake up the display, tap the star in the upper-left corner of the computer's thumbnail.

3. Tap the computer's thumbnail.

Setting a connected computer's resolution and refresh rate

The following table presents the recommend resolutions and refresh rates for the display's input sources:

Input source	Resolution	Refresh rate
USB Type-C	3840 × 2160	60 Hz (YCbCr) 30 Hz (RGB)
HDMI 1 HDMI 2 HDMI 3 HDMI 4	3840 × 2160	60 Hz
VGA	1920 × 1080	60 Hz

If possible, set any connected computers to these resolutions and refresh rates. See the connected computers' operating system documentation for instructions.

Using recommended cables

SMART recommends the following varieties of cable:

Cable type	Maximum length	Recommendation
HDMI	23' (7 m) ¹	Use only certified HDMI cables that have been tested to support the performance standard you require.
VGA	23' (7 m)	Use VGA cables with all pins in their connectors fully populated and wired.
Stereo 3.5 mm	20' (6 m)	[N/A]
USB 2.0	16' (5 m)	Use a USB extender if the distance between the computer and the display is greater than 16' (5 m). For more information, see <i>USB extenders</i> on page 16. USB 2.0 cables support Hi-Speed (480 Mbps), whether connected to a USB 2.0 or USB 3.0 receptacle. For SuperSpeed (5 Gbps), connect a USB 3.0 cable to a USB 3.0 receptacle.
USB 3.0	9' (3 m)	SMART supports only installations that use directly connected video and USB cables, AC-powered extenders, or USB extenders purchased from SMART. You might be able to use higher-grade cables that are longer than specified. If you have problems with such a cable or an extender of any type, test the connection with a shorter cable before contacting SMART Support.
USB Type-C	6' (2 m)	To use a USB Type-C cable for video, you need: <ul style="list-style-type: none">• A cable that supports USB 3.1 (Gen 1 or Gen 2)• A computer that supports Display Port Alternate Mode Passive USB Type-C cables are sufficient for 60 W charging. You might be able to use higher-grade cables that are longer than specified. If you have problems with such a cable or an extender of any type, test the connection with a shorter cable before contacting SMART Support.

Using cables that exceed these maximum lengths may produce unexpected results, degraded picture quality or degraded USB connectivity.

Sharing USB Type-B receptacles

The HDMI and VGA connectors on the connector panel share USB Type-B receptacles:

¹The performance of cables longer than 23' (7 m) is highly dependent on the cable's quality.

USB Type-B receptacle	Video connectors
Touch 1	<ul style="list-style-type: none">• HDMI 1• HDMI 2
Touch 2	<ul style="list-style-type: none">• HDMI 3• VGA

If two computers are connected to video connectors that share the same USB Type-B receptacle, you must disconnect the USB cable from the first computer and connect it to the second computer if you want to switch from one computer's input to the other's. For example, if a room computer is connected to HDMI 1 and a guest laptop is connected to HDMI 2, you must disconnect the USB cable from the room computer and connect it to the guest laptop when you want to switch to the guest laptop's input.

Connecting a SMART OPS PC module

If your organization has purchased a SMART OPS PC module, you or your organization's installers can install the OPS PC module in the display's accessory slot following the OPS PC module's installation instructions (smarttech.com/kb/171544). You can then view the OPS PC module's input on the display.

For more information about the PCM8 series of SMART OPS PC modules, see *SMART OPS PC module* on page 16.

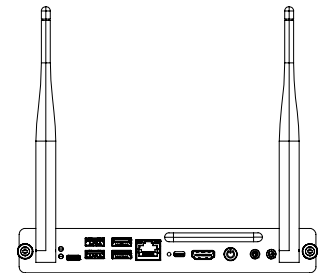

CAUTION

Do not install the OPS PC module or remove it from the accessory slot while the display is turned on. Ensure the power switch on the back of the display beside the AC power inlet is in the OFF (O) position.







TIP

You can install the SMART software that is included with the display on the OPS PC module. For more information about installing software, see *Installing SMART software* on page 30.

Viewing the OPS PC module input

To view the OPS PC module input

1. Do one of the following:

If iQ is enabled	If iQ is disabled
Tap the Home button  below the screen, and then tap Input  .	Tap the Home button  below the screen.
OR	OR
Press the Input button  on the remote control.	Press the Home button  or the Input button  on the remote control.

A screen appears, showing thumbnails of the inputs connected to the display, including the OPS PC module.

TIP

If iQ is disabled and you want the OPS PC module's input to appear whenever you wake up the display, tap the star in the upper-left corner of the OPS PC module's thumbnail.

2. Tap the OPS PC module input.

Connecting external displays

You can connect an external display to duplicate or extend the OPS PC module's desktop.

For more information, see *Connecting an external display* on page 40.

Connecting other devices

In addition to computers, you can connect the following devices to the display:

- USB drives, peripherals, and other devices
- External displays
- External audio systems
- Room control systems

Connecting USB drives, peripherals, and other devices

The display includes two USB 3.0 Type-A receptacles on the convenience panel and three USB 3.0 Type-A receptacles on the connector panel. You can connect USB drives, peripherals (such as keyboards), and other devices to these connectors and use the devices with the iQ experience, connected computers, and

devices installed in the accessory slot (such as the SMART OPS PC module).

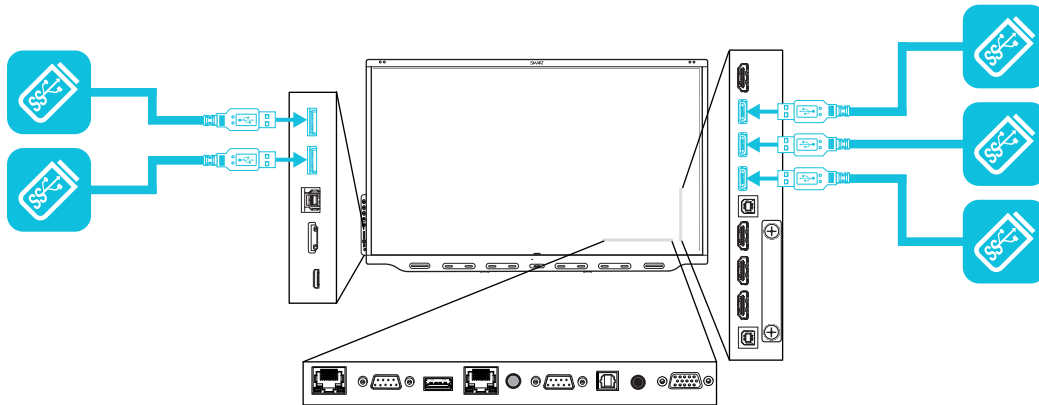

The following table shows which USB 3.0 Type-A receptacles you can use with each input source and the supported USB speed:

Input source	USB 3.0 Type-A receptacles on the convenience panel	USB 3.0 Type-A receptacles on the connector panel
iQ	✓ (SuperSpeed)	✓ (SuperSpeed)
HDMI 1	✓ (Hi-Speed)	
HDMI 2	✓ (Hi-Speed)	
HDMI 3	✓ (Hi-Speed)	
HDMI 4	✓ (SuperSpeed)	✓ (SuperSpeed)
USB Type-C	✓ (SuperSpeed)	✓ (SuperSpeed)
VGA	✓ (Hi-Speed)	
Accessory slot	✓ (SuperSpeed)	✓ (SuperSpeed)

NOTE

If a SMART OPS PC module is installed in the accessory slot, you can connect USB drives, peripherals, and other devices to the USB 2.0 Type-A, USB 3.0 Type-B, and USB Type-C receptacles on the OPS PC module to access those devices from the OPS PC module input.

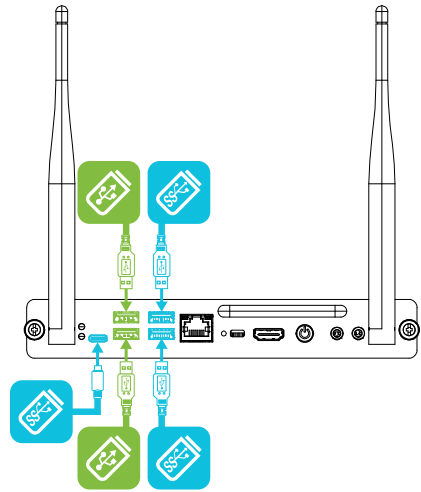

Connecting an external display

You can connect an external display using the HDMI 2.0 out connector on the connector panel (pictured). The external display will show the same image. This is useful when you're using the display in an auditorium or other large space where it would be beneficial to have a second display.

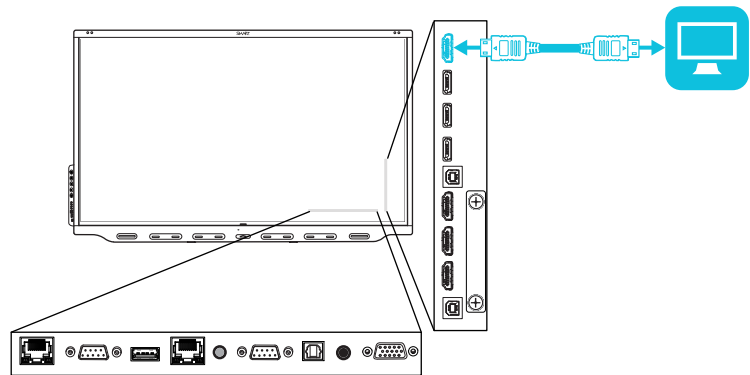

You can set the default resolution for the HDMI 2.0 out connector in the settings (see *Display* on page 66).

TIP

If a SMART OPS PC module is installed in the accessory slot, you can connect an external display to the HDMI 1.4 out connector on the OPS PC module rather than the one on the display. This allows you to duplicate or extend the OPS PC module's desktop to the external display.

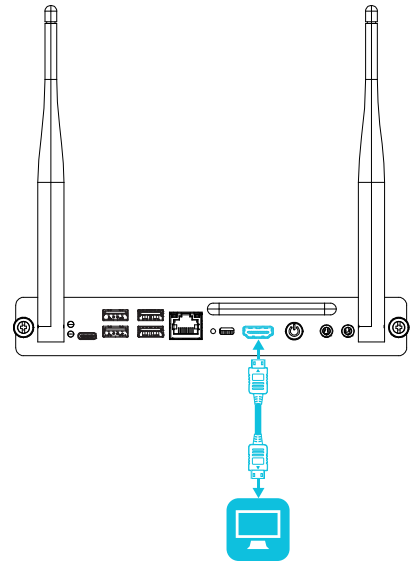

Connecting an external audio system

The display includes two 15 W speakers, which are designed to provide sound at the front of a room. You might want to connect the SBA-100 projection audio system (see *SBA-100 projection audio system* on page 16) or a third-party external audio system if you're providing sound in a larger space.

You can connect an external audio system to the display using the stereo 3.5 mm out connector (pictured). Alternatively, you can connect an external audio system directly to a room computer.

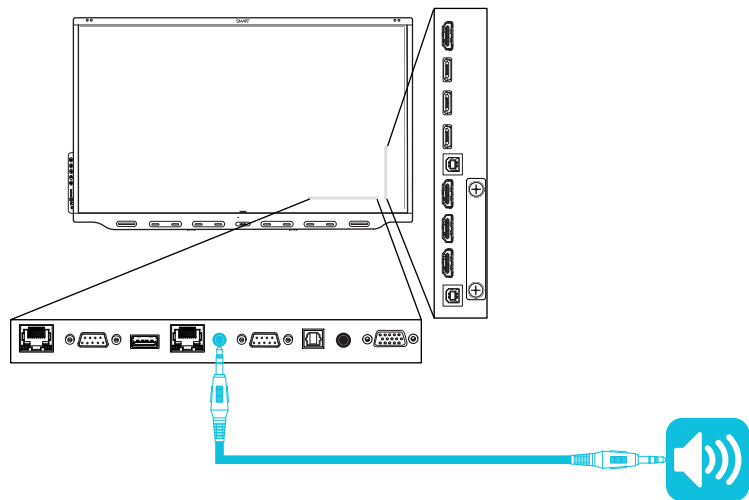

In addition to the stereo 3.5 mm out connector, the display provides a Sony/Philips Digital Interface (S/PDIF) out connector (pictured). S/PDIF is a digital audio transmission medium. You need an audio receiver that supports S/PDIF to decode this connection to analog for use with an external sound bar or other audio system.

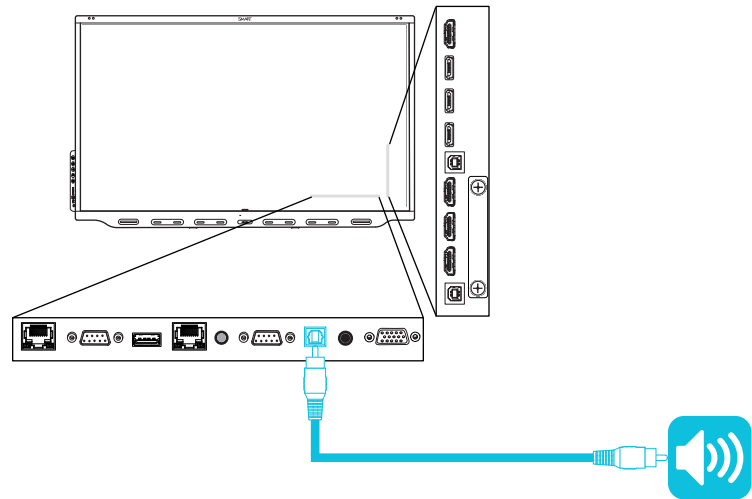

Connecting room control systems

A room control system enables users to control a room's lighting, audio system and, possibly, the display. Some installations may require you to integrate the display with a room control system.

You can use the display's RS-232 IN connector to connect a third-party external control system to the display (see *Appendix B: Managing the display using RS-232* on page 71).

NOTE

Displays are not compatible with centralized remote control systems, such as a universal remote control.

Connector diagrams

Connector panel

The following diagram and table present the connectors on the display's connector panel:

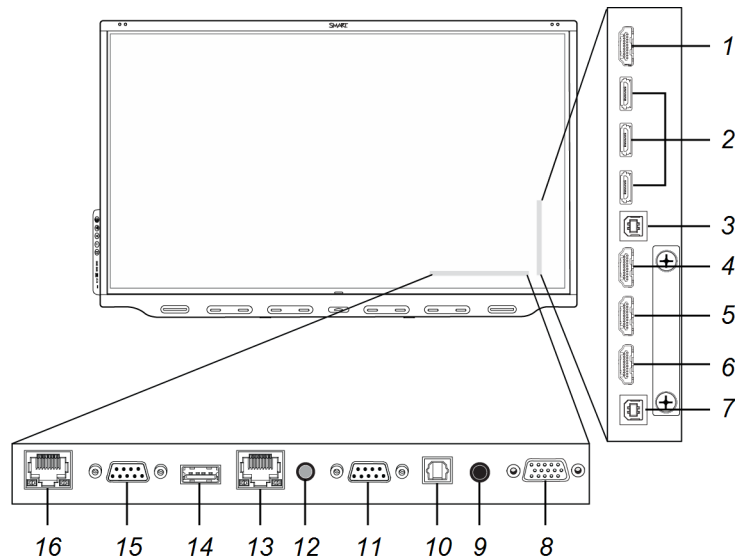

No.	Connector	Connects to	Notes
1	HDMI 2.0 out	External display	See page 40 and HDMI cables and connectors .
2	USB 3.0 Type-A (×3)	Supported USB drives, peripherals, and other devices	See <i>Connecting USB drives, peripherals, and other devices</i> on page 38 and USB cables and connectors .
3	USB Type-B	Touch 1 input	Use this touch input with the HDMI 1 or HDMI 2 video and audio inputs. See page 31 and USB cables and connectors .
4	HDMI 2.0 in	HDMI 1 input (video and audio)	Use this video and audio input with the Touch 1 input. See page 31 and HDMI cables and connectors .
5	HDMI 2.0 in	HDMI 2 input (video and audio)	Use this video and audio input with the Touch 1 input. See page 31 and HDMI cables and connectors .

No.	Connector	Connects to	Notes
6	HDMI 2.0 in	HDMI 3 input (video and audio)	Use this video and audio input with the Touch 2 input. See page 31 and HDMI cables and connectors .
7	USB Type-B	Touch 2 input	Use this touch input with the HDMI 3 or VGA video and audio inputs. See page 31 and USB cables and connectors .
8	VGA in	VGA input (video)	Use this video input with the Touch 2 input. See page 31 and VGA cables and connectors .
9	Stereo 3.5 mm in	VGA input (audio)	Use this audio input with the Touch 2 input. See page 31 and Analog audio cables and connectors .
10	S/PDIF out	Digital audio output	See page 41 and Digital audio cables and connectors .
11	RS-232 in	Room control system	See <i>Appendix B: Managing the display using RS-232</i> on page 71 and RS-232 cables and connectors .
12	Stereo 3.5 mm out	External audio system	See page 41 and Analog audio cables and connectors .
13	RJ45	Network	See page 25 and Ethernet (network) cables and connectors .
14	USB 2.0 Type-A	[N/A]	This connector is a service port.
15	RS-232 out	[N/A]	This connector is not currently supported.
16	RJ45	Room computer or guest laptop	See page 25 and Analog audio cables and connectors .

Convenience panel

The following diagram and table present the connectors on the display's convenience panel:

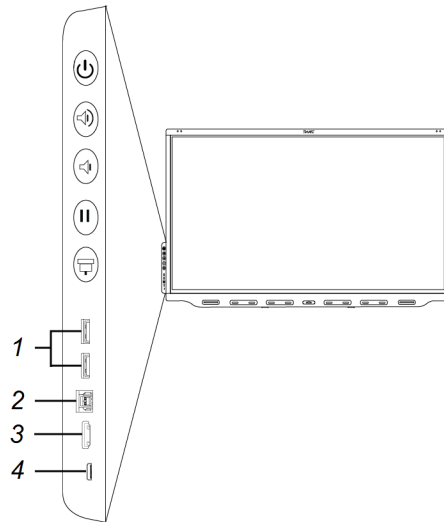

No.	Connector	Connects to	Notes
1	USB 3.0 Type-A (×2)	Supported USB drives, peripherals, and other devices	See <i>Connecting USB drives, peripherals, and other devices</i> on page 38 and USB cables and connectors .
2	USB Type-B	HDMI 4 input (touch)	See page 31 and USB cables and connectors .
3	HDMI 2.0 in	HDMI 4 input (video and audio)	See page 31 and HDMI cables and connectors .
4	USB Type-C	USB Type-C input	See page 31 and USB cables and connectors .

SMART OPS PC module (optional)

The following diagram and table present the connectors on the optional SMART OPS PC module:

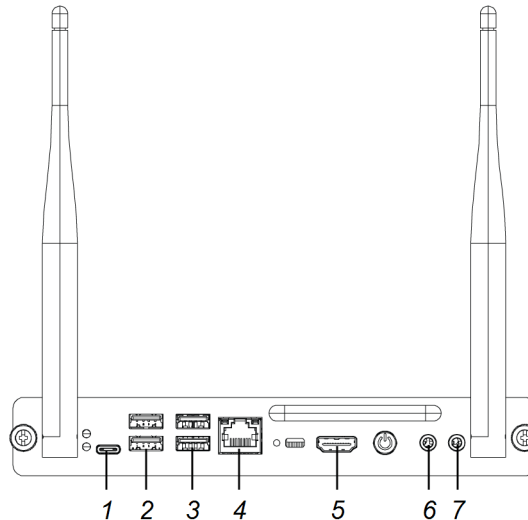

No.	Connector	Connects to	Notes
1	USB Type-C	Supported USB drives, peripherals, and other devices	See <i>Connecting USB drives, peripherals, and other devices</i> on page 38 and USB cables and connectors .
2	USB 2.0 Type-A (×2)	Supported USB drives, peripherals, and other devices	See <i>Connecting USB drives, peripherals, and other devices</i> on page 38 and USB cables and connectors .
3	USB 3.0 Type-A (×2)	Supported USB drives, peripherals, and other devices	See <i>Connecting USB drives, peripherals, and other devices</i> on page 38 and USB cables and connectors .
4	RJ45	[N/A]	The OPS PC module uses the display's network connection (if available), so you typically don't need to connect the OPS PC module directly to a network.
5	HDMI out	External display	See <i>Connecting an external display</i> on page 40 and HDMI cables and connectors .

No.	Connector	Connects to	Notes
6	Stereo 3.5 mm out	External speakers or headphones	[N/A]
7	Stereo 3.5 mm in	Microphone	[N/A]

Chapter 4

Maintaining the display

Turning off, turning on, and resetting the display	48
Cleaning and maintaining hardware	49
Checking the display installation	49
Cleaning the screen	50
Maintaining ventilation	50
Preventing condensation	50
Replacing the pens and erasers	51
Removing and transporting the display	51
Updating system software	52
Applying an automatic system software update manually	52
Updating system software manually	53

With proper maintenance, the display will provide years of use.

Turning off, turning on, and resetting the display

In most situations, you can put the display to sleep when not using it following the instructions in the *SMART Board 7000R and 7000R Pro series interactive displays user guide* (smarttech.com/kb/171539).

In some situations, such as when you transport the display or clean its screen, you need to turn the display off. You can turn it back on after.

You can also reset the display.

To turn the display off

1. Press the **Power** button  on the convenience panel or the remote control for five seconds.

A slider appears on the screen.

2. Move the slider to the right.

3. Flick the switch beside the AC power inlet to the OFF (O) position.

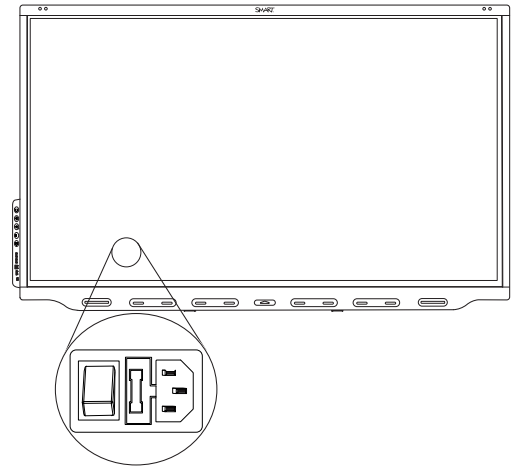

NOTE

Wait at least 30 seconds before turning the display back on.

To turn the display back on

1. Flick the switch beside the AC power inlet to the ON (I) position.
2. Press the **Power** button  on the convenience panel or the remote control.

To reset the display

Press and hold the **Power** button  on the convenience panel or the remote control for 10 seconds.

The display resets.

Cleaning and maintaining hardware

Checking the display installation

Inspect the display installation frequently to ensure that the display remains securely installed.

- Check the mounting location for signs of damage or weakness that can occur over time.
- Check for loose screws, gaps, distortions or other issues that could occur with the mounting hardware.

If you find an issue, contact a trained installer.

Cleaning the screen

Follow these instructions to clean the screen without damaging its anti-glare coating or other product components.

CAUTION

- Do not use permanent or dry-erase markers on the screen. If dry-erase markers are used on the screen, remove the ink as soon as possible with a lint-free, non-abrasive cloth.
- Do not rub the screen with dense or rough material.
- Do not apply pressure to the screen.
- Do not use cleaning solutions or glass cleaners on the screen, because they can deteriorate or discolor the screen.

To clean the screen

1. Turn off the display (see *Turning off, turning on, and resetting the display* on page 48).
2. Wipe the screen with a lint-free, non-abrasive cloth.

NOTE

You can also use a damp cloth with a drop of dish soap.

Maintaining ventilation

The display requires proper ventilation. Dust buildup in the ventilation holes compromises cooling and can lead to product failure.

- Clean accessible ventilation holes monthly with a dry cloth.
- Use a vacuum cleaner with a narrow hose end fitting to clear the back ventilation holes regularly. You might have to remove the display from the wall.

For more information about removing the display, see *Removing and transporting the display* on the next page.

CAUTION

Avoid setting up or using the display in an area with excessive levels of dust, humidity, or smoke.

Preventing condensation

If the display has been moved from a cold environment to a warmer one (for example, from storage to the installation site), let the display sit for a few hours to allow it to acclimate to the new temperature. Failing to do so can cause humidity to build up in the space between the front glass and the LCD.

If condensation appears under the screen after you turn on the display, select an active video source and leave the display on for 48 hours. If the condensation doesn't dissipate, contact SMART Support if the display is still under warranty.

If there is enough moisture between the layers to cause the moisture to drip and run, remove power immediately and contact SMART Support if the display is still under warranty.

Replacing the pens and erasers

To prevent damage to the display's anti-glare coating, replace a pen if its nib or eraser pad become worn. You can purchase replacement pens and erasers from the Store for SMART Parts (see smarttech.com/support/parts-store).

IMPORTANT

Use only pens designed for SMART Board 7000R and 7000R Pro series interactive displays. Pens for other SMART products, including SMART Board 7000 and 7000 Pro series interactive displays, aren't compatible with SMART Board 7000R and 7000R Pro series interactive displays (see smarttech.com/kb/171230).

NOTE

For pen and eraser part numbers, refer to the service parts diagrams.

Removing and transporting the display

If the display is wall mounted, you might need to remove it from its current location and transport it to another location on occasion.

To remove the display safely, use two or more trained installers.

WARNING

- Do not attempt to move the display by yourself. The display is very heavy.
- Do not move the display by connecting a rope or wire to the handles on the back. The display can fall and cause injury and product damage.

IMPORTANT

Follow any documentation included with the third-party mounting hardware.

To remove the display

1. Turn off any connected computers.
2. Turn off the display (see *Turning off, turning on, and resetting the display* on page 48).
3. Flick the switch beside the AC power inlet to the OFF (O) position.
4. Remove all accessible cables and connectors.
5. Remove the iQ appliance from the accessory slot.
6. Lift the display from its mounting location.

 **WARNING**

Do not place the display on a sloping or unstable cart, stand, or table. The display could fall, resulting in injury and severe product damage.

 **CAUTION**

Do not leave the display face up, face down or upside down for an extended period. This could cause permanent damage to the screen.

7. Remove the mounting brackets.

To transport the display

See *Moving the display to the installation site* on page 18.

Updating system software

When an update to the system software or firmware is available, the display downloads the update in the background then waits for four hours of inactivity. When that happens, the display shows a two-minute countdown before beginning the update. The countdown can be interrupted at any time. The update begins when the countdown finishes. The display shows a blank screen for four minutes. When the update is complete, the display shows the Whiteboard and any content that was on Whiteboard before the update.

NOTE

You can configure your organization's network to allow or prevent automatic system software and firmware updates (see [Connecting to a network](#)).

Applying an automatic system software update manually

If the display has downloaded but not yet applied the system software, you can start the update process manually from Settings.

To apply an automatic system software update manually

1. From the Home screen, tap **Settings** .
2. Scroll to **Auto Update**.
3. Under *Check for Updates Now*, tap **Apply Update Now**.

The display turns off and then turns back on. The display then applies the update.

Updating system software manually

You can download system software updates at smarttech.com/downloads and update your display using a USB drive.

Chapter 5

Troubleshooting

- The display isn't turning on 54
- The display is turning on when it shouldn't 55
- The screen is blank or there's a problem with the image on the screen 55
- There's no sound or there's a problem with the sound 57
- Touch isn't working as expected 57
- The pens and erasers aren't working as expected 58
- iQ apps aren't working as expected 59
- SMART software on connected computers isn't working as expected 59
- The SMART OPS PC module isn't working as expected 60
- Contacting your reseller for additional support 60

This chapter explains how to resolve a variety of common issues with the display and SMART OPS PC module (if installed). If the symptoms you're encountering aren't covered below or the solutions to the symptoms don't work, refer to the SMART knowledge base for additional troubleshooting information

community.smarttech.com/s/topic/0TOU0000000kAJ0OAM/interactive-displays







The display isn't turning on

Symptom	Troubleshooting steps
The power light isn't lit.	<ul style="list-style-type: none">• Make sure the power cable is securely fastened to the power outlet and the display. <hr/> <p>NOTE</p> <p>If the power cable is connected to a power bar, make sure the power bar is securely fastened to the power outlet and turned on.</p> <hr/> <ul style="list-style-type: none">• Make sure the switch beside the AC power inlet is in the ON (I) position.• Make sure the power outlet is working by testing it with a different device.• Make sure the power cable is working by testing it with a different device.
The power light is lit, but the screen is blank.	<ul style="list-style-type: none">• Pick up a pen or press the Power button on the convenience panel or the remote control.• Make sure the proximity sensors aren't blocked.• Restart the display. <i>See Turning off, turning on, and resetting the display on page 48.</i>• Determine if the problem is with the video. <i>See The screen is blank or there's a problem with the image on the screen below.</i>

The display is turning on when it shouldn't

Symptom	Troubleshooting steps
The display turns on or enters Ready mode when it shouldn't.	<ul style="list-style-type: none">• Check for and, if possible, move the display away from the following:<ul style="list-style-type: none">◦ Direct sunlight◦ Bright lights◦ Forced air ducts◦ Plasma displays◦ Infrared audio systems and other infrared sources◦ Polished floors, glass walls, or other reflective surfaces• Be aware that the proximity sensors' range is 16' (5 m).

The screen is blank or there's a problem with the image on the screen

Symptom	Troubleshooting steps
The screen is blank.	<ul style="list-style-type: none"> • Make sure the screen is working by tapping the Home button  below the screen or pressing the Home button  on the remote control to open the Home screen. • Make sure any connected computers are on and not in Sleep mode. • Restart the display and any connected computers. <i>See Turning off, turning on, and resetting the display on page 48.</i> • Replace the video cables connecting any computers to the display to determine if the issue is with the cables.
A computer is connected to the display, but only a connection message appears on the screen.	<ul style="list-style-type: none"> • Make sure the computer is connected to the currently selected input. • If the currently selected input is a computer, make sure the computer is not in Sleep mode.
<p>The image on the screen is distorted.</p> <p>OR</p> <p>There are lines, snow or, other visual noise on the screen.</p> <p>OR</p> <p>The image is flickering or flashing.</p> <p>OR</p> <p>The image is dim.</p>	<ul style="list-style-type: none"> • Tap the Home button  below the screen or press the Home button  on the remote control to open the Home screen. If it appears correctly, the issue is with the video input. • Switch to a different input and then back to the first input. • Make sure any connected computers are on and not in Sleep mode. • Restart the display and any connected computers. <i>See Turning off, turning on, and resetting the display on page 48.</i> • Set any connected computers' resolution and refresh rate to values that the display supports. • Replace the video cables that connect any computers to the display to determine if the issue is with the cables.
There are bright spots on the screen.	<ul style="list-style-type: none"> • Tap the Home button  below the screen or press the Home button  on the remote control to open the Home screen. If it appears correctly, the issue is with the video input. • Take a photograph of the screen and send it to SMART support. If SMART support determines that the issue is with the screen and the display is under warranty, you may be eligible for a replacement.
Colors don't appear correctly.	<ul style="list-style-type: none"> • Be aware that if two or more displays are mounted side-by-side, there could be minor differences in colors across the displays. This issue is not unique to SMART products. • If the screen is completely lacking one color on the screen or the color problems occur on the Home screen, see Contacting your reseller for additional support on page 60. • If you're using a VGA video input, use a different cable or connect a different source to see if the issue is with the cable or input source.

Symptom	Troubleshooting steps
The image is cut off or shifted to the left or right.	<ul style="list-style-type: none"> Adjust any connected computers' video settings, particularly zoom, crop, and underscan. See the computer's operating system documentation. If any connected computers' desktops are entirely black, change them to dark gray or a different color. If any connected computers' desktops are extended across multiple screens, duplicate the desktops across the screens or set the display as the only screen.
The image doesn't fill the entire screen.	<ul style="list-style-type: none"> Adjust any connected computers' video settings, particularly overscan. See the computer's operating system documentation. Make sure the connected computer's video connector is configured to output a supported video signal. See No video display output from a laptop.
A persistent image appears on the display.	See Image persistence or burn in on LCD displays .

There's no sound or there's a problem with the sound

Symptom	Troubleshooting steps
There's no sound. OR There is sound, but the volume is low. OR The sound is distorted or muffled.	<ul style="list-style-type: none"> If you're using an external audio system, make sure it is turned on. Make sure the cables connecting the display to the computer are securely fastened. <hr/> <p>NOTES</p> <ul style="list-style-type: none"> The display's stereo 3.5 mm in connector works with the VGA input only. Connecting an audio cable to the display's stereo 3.5 mm out connector disables the internal speakers. If you're using the display's S/PDIF out connector to connect a sound bar or receiver for external speakers, see <i>Connecting an external audio system</i> on page 41. <hr/> <ul style="list-style-type: none"> If you're using the display's stereo 3.5 mm out connector, adjust the volume on the display and the connected computer and make sure neither are muted. If you're using the display's S/PDIF out connector, adjust the volume on the external audio system and make sure the audio system isn't muted. Adjust the display's audio settings. See <i>Audio</i> on page 67. If you're using the integrated speakers, set the volume for the computer and any running applications to 80%, and then adjust the display's volume. <p>OR</p> <p>If you're using an external audio system, set the volume for the computer, any running applications and the display to 80%, and then adjust the external audio system's volume.</p>
There is a whine or buzzing sound coming from the back of the display.	<ul style="list-style-type: none"> Be aware that these sounds are normal. All displays emit some electrical noise. Such sounds may be more noticeable with some displays than with others. However, if you hear noise from the front of the display, further investigation is required. Connect all devices to the same power outlet or power bar.

Touch isn't working as expected

Symptom	Troubleshooting steps
The display doesn't respond to touch.	<ul style="list-style-type: none">• Make sure SMART Product Drivers 12.14 or later are installed and running on any connected computers.• Make sure the USB cable between the display and the computer doesn't exceed the supported maximum cable length. See <i>Using recommended cables</i> on page 36.• Make sure any connected computers have detected the display's USB connection and SMART Product Drivers 12.14 or later is installed.• On Windows computers, open Device Manager and make sure there is no red X or yellow explanation mark (!) over the display's icon.• On Mac computers, open System Information and make sure there are no error messages in the display's row.• For Mac computers with macOS Mojave, see How to resolve issues with installing and using SMART Learning Suite software on macOS Mojave.
The display responds to touch intermittently. OR When you touch the screen, the pointer doesn't appear in the correct place.	<ul style="list-style-type: none">• Restart the display. See <i>Turning off, turning on, and resetting the display</i> on page 48.• Make sure SMART Product Drivers and SMART Ink are installed and running on any connected computers.• Confirm with the installers that the computer is connected to the display with only a single cable.• Remove infrared sources, such as incandescent or arc lights, desk lamps, and infrared audio devices, or move the display to another location in the room.• Remove any USB extenders to help isolate the USB cable.• Update the firmware.

The pens and erasers aren't working as expected

Symptom	Troubleshooting steps
The display doesn't respond to touch or writing with a pen.	<ul style="list-style-type: none">• Make sure any connected computers have detected the display's USB connection and SMART Product Drivers 12.14 or later is installed.• On Windows computers, open Device Manager and make sure there is no red X or yellow explanation mark (!) over the display's icon.• On Mac computers, open System Information and make sure there are no error messages in the display's row.• Reinstall or update SMART Product Drivers and SMART Ink on any connected computers.• Make sure SMART Product Drivers is version 12.14 or later.
The display responds to touch but not to writing with a pen.	<ul style="list-style-type: none">• Reinstall or update SMART Product Drivers and SMART Ink on any connected computers.

Symptom	Troubleshooting steps
When you write on the screen, the ink appears in the wrong place. OR Writing is intermittent. OR Ink disappears as you write. OR Ink colors change unexpectedly.	<ul style="list-style-type: none"> Restart the display. See <i>Turning off, turning on, and resetting the display</i> on page 48. Confirm with the installers that the computer is connected to the display with only a single cable. Make sure SMART Product Drivers and SMART Ink are installed and running on any connected computers. Use a known working pen from another display to check if the issue is being caused by the pen. Remove infrared sources, such as incandescent or arc lights, desk lamps, and infrared audio devices, or move the display to another location in the room. Update the firmware.
You change the width or color of a pen's digital ink, but the width and color revert to the pen's defaults when you next pick up the pen from its holder on the display.	<ul style="list-style-type: none"> Be aware that a pen's color and thickness revert to the pen's default values when you place the pen back in its holder. You can change the pen's default color and thickness through SMART Product Drivers (see Changing pen, eraser, and button settings).
You're experiencing other issues with the pens.	<ul style="list-style-type: none"> Use only SMART Board 7000R or 7000R Pro series interactive display pens with the display. Pens from other interactive displays aren't compatible. Return the pen to its magnetic holder to calibrate it. Make sure the pen's pressure sensitive switch isn't damaged or dirty. If one pen isn't working, make sure the pen is paired with the display and is fully charged. If all pens aren't working, return the pens to their magnetic holders and restart the display.
You can't write or draw in Microsoft Office.	<ul style="list-style-type: none"> Make sure Microsoft Office 2013 or later is installed. Reinstall or update SMART Product Drivers and SMART Ink.

iQ apps aren't working as expected

Symptom	Troubleshooting steps
iQ apps aren't working as expected.	See Troubleshooting the iQ experience .

SMART software on connected computers isn't working as expected

Symptom	Troubleshooting steps
SMART Notebook software isn't working as expected.	See Troubleshooting SMART Notebook .

Symptom	Troubleshooting steps
SMART Learning Suite Online isn't working as expected.	See Troubleshooting common issues in SMART Learning Suite Online .
SMART TeamWorks software isn't working as expected.	See Troubleshooting SMART TeamWorks .
SMART Meeting Pro software isn't working as expected.	See Basic troubleshooting for SMART Meeting Pro .
SMART Ink isn't working as expected.	See Troubleshooting SMART Ink .
SMART Product Drivers isn't working as expected.	See Troubleshooting SMART Product Drivers .

The SMART OPS PC module isn't working as expected

Symptom	Troubleshooting steps
The on-screen keyboard isn't visible.	<ul style="list-style-type: none"> • Enable the on-screen keyboard: <ol style="list-style-type: none"> a. Select Start > Settings. The <i>Settings</i> window appears. b. Tap Ease of Access, and then tap Keyboard. c. Enable Use the On-Screen Keyboard. For more information, see Use the On-Screen Keyboard (OSK) to type. • Enable tablet mode: <p>Tap the notification icon  in the bottom-right corner of the screen and then select Tablet mode.</p> For more information, see Turn tablet mode on or off.
Windows 10 or the OPS PC module is unresponsive.	<ul style="list-style-type: none"> • Restart the OPS PC module: <ol style="list-style-type: none"> a. Press and hold the power button on the OPS PC module. b. Wait two minutes. c. Press the power button to turn on the OPS PC module. • If restarting the OPS PC module doesn't resolve the issue, contact SMART support.
There is an issue with Bluetooth.	See Fix Bluetooth problems in Windows 10: FAQ .
There is an issue with the network connection.	See Fix network connection issues in Windows .

Contacting your reseller for additional support

If an issue you're experiencing with the display persists or isn't covered in this chapter or the knowledge base, contact your authorized SMART reseller (smarttech.com/where) for support.

Your reseller might ask you for the serial number for the display. The serial number is on a label located on the left side of the display (pictured).

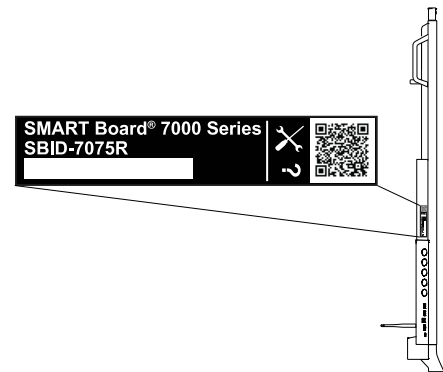

TIPS

- Scan the QR code on the label to view the SMART Board 7000R or 7000R Pro series interactive display support pages on the SMART website.
 - You can also find the serial number in the iQ settings (see *Serial Number* on page 70).
-

Appendix A

Adjusting settings

Network settings	62
Personalization	63
Application settings	64
System settings	66

You can access settings using the  icon on the Home screen.

NOTES

- Settings can apply to a user or to the entire system. User-level settings change depending on the user who is signed in. System-level settings apply to all users. See the settings for more information.
- Some settings aren't available while you're signed in to your SMART account. Sign out of your SMART account on the display to see all settings.

Network settings

Option	Values	Function	Notes	User or system setting
▶ Wi-Fi				
• Wi-Fi	On Off	Enables or disables Wi-Fi on the display.	Turn on Wi-Fi to discover networks.	System
• [Wi-Fi network name]	[N/A]	Shows information about the connected wireless network.	[N/A]	System
• Wi-Fi MAC address	[N/A]	Shows MAC address for the network the display is connected to.	[N/A]	System
• Wi-Fi IP address	[N/A]	Shows IP address for the network the display is connected to.	[N/A]	System

Option	Values	Function	Notes	User or system setting
▶ SMART iQ Ethernet				
• Advanced options	[N/A]	Options available when an Ethernet cable is connected	[N/A]	System
• Static IP (Use DHCP)	On Off	Enables or disables DHCP to assign the display an IP address.	[N/A]	User
• Proxy (Use proxy)	On Off	Enables or disables a proxy server for connecting to the network.	[N/A]	User
• Proxy (Auto-configure)	On Off	Enables or disables automatic configuration of the proxy server for connecting to the network.	[N/A]	User
• MAC address	[N/A]	Shows information about the network the display is connected to.	[N/A]	System
• Static IP	[N/A]	Shows information about the network the display is connected to.	[N/A]	System
• Proxy	[N/A]	Shows information about the network the display is connected to.	[N/A]	System
▶ SMART Board scaler ethernet				
• MAC address	[N/A]	Shows information about the network the display's scaler is connected to.	[N/A]	System
• IP address	[N/A]	Shows information about the network the display's scaler is connected to.	[N/A]	System
• Bluetooth	[N/A]	Shows information about the display's Bluetooth.	Turn on Bluetooth to view available Bluetooth devices.	System
▶ SMART Cloud				
• SMART Cloud Status	[Status]	Shows the status of SMART Cloud.	[N/A]	System
• Service Region	[N/A]	Shows the service region.	[N/A]	System

Personalization

NOTE

If iQ is disabled, Personalization settings are not available.

Option	Values	Function	Notes	User or system setting
<ul style="list-style-type: none"> Wallpaper 	[Wallpapers]	Select the wallpaper that appears in the background.	<ul style="list-style-type: none"> 1920 × 1080 images work best The display supports .png and .jpg file formats See Changing the display's wallpaper. 	User

Application settings

NOTE

If iQ is disabled, Application settings are not available.

Option	Values	Function	Notes	User or system setting
▶ Launcher				
<ul style="list-style-type: none"> SMART Notebook Player 	On Off	Enables or disables SMART Notebook Player in the Apps Library.	[N/A]	User
<ul style="list-style-type: none"> Browser 	On Off	Enables or disables Browser in the Apps Library.	[N/A]	User
<ul style="list-style-type: none"> Input 	On Off	Enables or disables Input in the Apps Library.	[N/A]	[N/A]
<ul style="list-style-type: none"> Screen Share 	On Off	Enables or disables Screen Share in the Apps Library.	[N/A]	User
▶ SMART Whiteboard				
<ul style="list-style-type: none"> Whiteboard Storage 	[N/A]	[N/A]	[N/A]	User
<ul style="list-style-type: none"> Library 	On Off	Enables or disables saving kapp Whiteboard sessions.	[N/A]	User
<ul style="list-style-type: none"> Save Whiteboards in Library 	For 1 week For 1 Month Indefinitely	Sets how long kapp Whiteboard sessions are saved.	[N/A]	User
<ul style="list-style-type: none"> Mobile App 				

Appendix A
Adjusting settings

Option	Values	Function	Notes	User or system setting
<ul style="list-style-type: none"> Saving Whiteboards 	On Off	Enables or disables the Capture function in the SMART kapp app.	If this option is off, the QR code is not visible. The SMART kapp app cannot connect to the display and your mobile device cannot save snapshots of the display in the app.	User
<ul style="list-style-type: none"> Sharing Whiteboards 	On Off	Enables or disables the Invite function on the SMART kapp app.	If this option is off, you cannot invite people to your session.	User
<ul style="list-style-type: none"> Annotation 				
<ul style="list-style-type: none"> Enable annotation layers 	On Off	Enables or disables annotations on the Browser and Screen Share apps.	[N/A]	User
<ul style="list-style-type: none"> ▶ Screen Share 				
<ul style="list-style-type: none"> Require Permission 	On Off	Enables or disables automatic connection from a device sharing its screen.	[N/A]	System
<ul style="list-style-type: none"> AirPlay 	On Off	Enables or disables the AirPlay protocol.	AirPlay is enabled by default.	System
<ul style="list-style-type: none"> Google Cast 	On Off	Enables or disables the Google Cast protocol.	Google Cast is enabled by default.	System
<ul style="list-style-type: none"> Miracast 	On Off	Enables or disables the Miracast protocol.	<p>Miracast is enabled by default.</p> <p>ⓘ IMPORTANT</p> <p>Devices that use AirPlay and Google Cast can't connect to the display while a Miracast device is connected.</p>	System
<ul style="list-style-type: none"> Performance Logging 	On Off	SMART Support may ask users to enable Performance Logging to help diagnose issues.	Performance Logging is disabled by default.	System

Option	Values	Function	Notes	User or system setting
<ul style="list-style-type: none"> Miracast Connection Handling 	On Off	When enabled, the display disconnects from the network when a device shares its screen using Miracast.	<p>SMART recommends enabling this setting for areas with high network saturation or busy networks.</p> <p>! IMPORTANT</p> <p>Only one device can connect to the display when Miracast is enabled.</p>	System
<ul style="list-style-type: none"> Reset Screen Share 	[N/A]	Closes and restarts the Screen Share app and its discovery services.	You can restart Screen Share as a troubleshooting step if a mobile device or computer can't find or connect to the display.	System

System settings

Option	Values	Function	Notes	User or system setting
▶ System				
<ul style="list-style-type: none"> SMART Board with iQ 	On Off	Enables or disables the iQ experience.	[N/A]	System
<ul style="list-style-type: none"> Default input 	Inputs available on the display.	Select the default input the display will use when starting.	The iQ embedded experience is the default input.	System
▶ Display				
• Screen Adjustment				
<ul style="list-style-type: none"> Brightness 	0–100	Sets the overall brightness of the image.	[N/A]	System
<ul style="list-style-type: none"> Contrast 	0–100	Sets the difference in brightness between the lightest and darkest parts of the image.	[N/A]	User
• Power Management				
<ul style="list-style-type: none"> Turn on when people are nearby 	On Off	Sets the display to turn on if the presence detection sensors detects users in the room.	This option is off by default.	System

Appendix A
Adjusting settings

Option	Values	Function	Notes	User or system setting
<ul style="list-style-type: none"> Sleep 	Disabled 1 minute 5 minutes 30 minutes 60 minutes 90 minutes	Sets the number of minutes of inactivity before the display goes to sleep.	The default is 60 minutes.	System
<ul style="list-style-type: none"> HDMI Output 				
<ul style="list-style-type: none"> Default resolution 	Auto 4K60 1080p60 720p60 640x480p60	Sets the HDMI out resolution.	[N/A]	System
▶ Audio				
<ul style="list-style-type: none"> Speakers 				
<ul style="list-style-type: none"> Built-in Speakers 	On Off	Enables or disables the display's internal speakers.	When analog speakers are connected to the display, the display's internal speakers are disabled automatically.	System
<ul style="list-style-type: none"> Audio Properties 				
<ul style="list-style-type: none"> Balance 	0–100	Sets the audio output from the speakers.	Drag the slider all the way to the left to have all audio from the left speaker. Drag the slider all the way to the right to have all the audio from the right speaker.	System
<ul style="list-style-type: none"> Bass 	0–100	Sets the bass level.	[N/A]	System
<ul style="list-style-type: none"> Treble 	0–100	Sets the treble level.	[N/A]	System

Appendix A
Adjusting settings

Option	Values	Function	Notes	User or system setting
▶ Date & Time				
<ul style="list-style-type: none"> Automatic Date & Time 	On Off	Sets the display's date and time automatically.	Configure the network to allow Network Time Protocol (NTP) requests to internet time servers. See Connecting to a network .	System
<ul style="list-style-type: none"> Date 	[N/A]	Sets the display's date.	Disable Automatic date & time to set the date manually.	System
<ul style="list-style-type: none"> Time 	[N/A]	Sets the display's time.	Disable Automatic date & time to set the time manually.	System
<ul style="list-style-type: none"> 24 Hour Time 	On Off	Shows the display's time using the 24-hour clock.	[N/A]	User
<ul style="list-style-type: none"> Time Zone 	[N/A]	Sets the display's time zone.	[N/A]	System
<ul style="list-style-type: none"> Language 	[Languages]	Sets the language for the settings menu.	[N/A]	User
<ul style="list-style-type: none"> Country 	[Countries]	Sets the display's country.	[N/A]	System
▶ Diagnostics				
<ul style="list-style-type: none"> Factory Reset 	[N/A]	Resets all options to their default values.	Only administrators should reset the display.	[N/A]
<ul style="list-style-type: none"> Save Log File 	[N/A]	Copy diagnostic logs to a USB drive.	[N/A]	[N/A]
<ul style="list-style-type: none"> Improve the Experience 	On Off	Sends usage statistics and error reports to SMART.	[N/A]	User
<ul style="list-style-type: none"> Support ID 	[Support ID]	Shows the support ID associated with the display.	[N/A]	[N/A]
▶ Security				
<ul style="list-style-type: none"> Lock Down Settings 	[N/A]	Lock down the display's settings using a certificate on a USB drive.	See Locking down the Settings app for more information.	System
<ul style="list-style-type: none"> Install certificates 	[N/A]	Install certificates to connect to a network.	[N/A]	System

Appendix A
Adjusting settings

Option	Values	Function	Notes	User or system setting
• Clean up				
• Clean Up Policy	Disabled Manually reset with the Clean Up button in the launcher 1 hour 2 hours 3 hours 1 day	Sets how often the display cleans up.	[N/A]	User
• Clean Up the whiteboard	[N/A]	Saves the Whiteboard session to the Library and erases the Whiteboard.	[N/A]	User
• Clean Up the browser	[N/A]	Closes the browser tabs and clears the history, cache, and cookies.	[N/A]	User
• Clean Up other applications	[N/A]	Closes open applications.	[N/A]	User
▶ Software Update				
• Updates Channel	Stable Channel Beta Channel	Sets which IQ system software updates the display receives.	When switching from the Beta channel to the Stable channel, a factory reset occurs. See page 68 for more information about factory reset. For more information about the Beta Channel, see Switching to the Beta channel .	System
• System Updates Channel	Stable Channel Beta Channel	Sets which display updates the display receives.	[N/A]	System
• Check for Updates Now	[N/A]	Checks for updates to the system software. NOTE The display must be connected to the internet to check for system software updates or a USB drive with the system software update file is connected to the display.	If an update is available, the text changes to Apply update now.	[N/A]

Appendix A
Adjusting settings

Option	Values	Function	Notes	User or system setting
▶ Remote Management				
• Launch Remote Management Settings	[N/A]	Configure the display's connection settings with the Radix Viso server.	This option is only enabled when Remote Management is enabled.	System
• Remote Management Enabled	On Off	Enables or disables Remote Management on the display.	[N/A]	User
• Radix Viso version	[N/A]	Shows the Radix Viso version.	[N/A]	System
▶ About				
• Board Name	[N/A]	Select a name for your display.	[N/A]	System
• Help	[N/A]	Shows the SMART support site.	[N/A]	[N/A]
• Send Feedback	[N/A]	Send feature request to SMART.	[N/A]	[N/A]
• Board Details	[N/A]	[N/A]	[N/A]	[N/A]
• Build Number	[N/A]	Shows the iQ system software's version number.	[N/A]	[N/A]
• Serial Number	[N/A]	Shows the display's serial number.	[N/A]	[N/A]
• Firmware Details	[N/A]	[N/A]	[N/A]	[N/A]
• Pen tray firmware version	[N/A]	Shows the display's pen tray firmware version.	[N/A]	[N/A]
• Touch controller version	[N/A]	Shows the display's touch controller version.	[N/A]	[N/A]
• Scaler version	[N/A]	Shows the display's scaler version.	[N/A]	[N/A]
• Home button firmware version	[N/A]	Shows the display's home button firmware version.	[N/A]	[N/A]
• Legal Information	[N/A]	[N/A]	[N/A]	[N/A]
• End User License Agreement	[N/A]	Shows the SMART end user license agreement.	[N/A]	[N/A]
• Open Source Licenses	[N/A]	Shows the open source licenses.	[N/A]	[N/A]
• SMART Intellectual Property	[N/A]	Shows the SMART intellectual property information.	[N/A]	[N/A]

Appendix B

Managing the display using RS-232

Configuring the computer's serial interface settings	72
Power states	73
Commands and responses	73
Power state commands	75
Input commands	76
Brightness commands	76
Freeze commands	76
Screen shade commands	77
Volume commands	77
Mute commands	77
Firmware version commands	77
Serial number commands	78
Part number commands	78
Asynchronous state reporting commands	78
Factory reset commands	78
Resolving issues with managing the display using RS-232	79

You can connect an RS-232 cable from a computer's serial output to the display's RS-232 in connector to remotely select video inputs, turn the display on or off, and get information about the display's current settings, such as volume and power state.

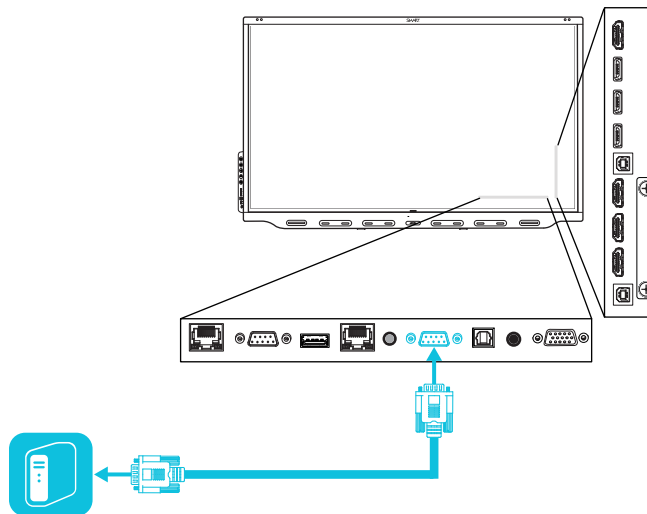

! **IMPORTANT**

Use only a standard RS-232 cable. Do not use a null modem cable. Null modem cables typically have ends of the same type.

TIP

SMART also offers SMART Remote Management cloud-based device-management software, which you can use to manage SMART Board interactive displays with iQ and devices running Windows, Chrome™ OS, Android™, and iOS operating systems. For more information, see [SMART Remote Management](#).

Configuring the computer's serial interface settings

Configure the computer's serial interface before sending commands to the display.

To configure the computer's serial interface

1. Turn on the display.
2. Turn on the computer, and then start the serial communications program or terminal emulation program.
3. Activate local echo.
4. Configure the serial interface settings using the following values, and then press ENTER.

Baud rate	19200
Data length	8
Parity bit	None
Stop bit	1



A command prompt (>) appears on the following line, and the display can now accept commands from the computer.

NOTE

If no message appears or an error message appears, the serial interface isn't configured correctly. Repeat steps 3 and 4.

Power states

The display has six power states:

Power state	Description
ON	The display is in normal operating mode.
READY	The screen is off, but the display is ready to turn on when one of the following occurs: <ul style="list-style-type: none">• A user presses the Power button  on the convenience panel or the remote control.• A user picks up a pen or the eraser.• You send the <code>set powerstate=on</code> command.
STANDBY	The screen is off, and the display is in a low power state. The display enters READY or ON state when one of the following occurs: <ul style="list-style-type: none">• The proximity sensors detect people in the room.• A user presses the Power button  on the convenience panel or the remote control.• You send the <code>set powerstate=ready</code> or <code>set powerstate=on</code> command.
UPDATEON	The display is updating firmware. Do not turn off the display.
UPDATEREADY	The display is updating firmware while the screen is off. Do not turn off the display.

With the exception of `get powerstate` and `set powerstate`, commands are available only when the display is in READY or ON power state.

Commands and responses

To access display information or to adjust display settings using the room control system, type commands after the command prompt (`>`) and wait for the response from the display.

CORRECT

```
>get volume  
volume=55  
>
```

If you type a command that the room control system doesn't recognize, you receive an invalid command response.

In the example below, the user used `--50` instead of `-50`.

INCORRECT

```
>set volume=-50  
invalid cmd: setvolume=-50  
>
```

NOTES

- Use ASCII formatted commands.
- Commands aren't case-sensitive and extra spacing is ignored.
- You can use the BACKSPACE key when typing commands.
- Review each entry carefully before you press ENTER.
- Don't send another command until you receive the response and the next command prompt.

To retrieve a setting's current value

Use a `get` command.

This example shows how to get the volume:

```
>get volume  
volume=55  
>
```

To assign a value to a setting

Use a `set` command.

This example sets the volume to 65:

```
>set volume=65  
volume=65  
>
```

To increase or decrease the value of a setting

Use the set command to increase or decrease the value by a designated number.

This example increases the volume by 5:

```
>set volume+5  
volume=70  
>
```

This example decreases the volume by 15:

```
>set volume-15  
volume=55  
>
```

Power state commands

Get command	Set command	Response
get powerstate	<p>set powerstate[Value] Where [Value] is one of the following:</p> <ul style="list-style-type: none">• =on• =ready• =standby <hr/> <p>NOTE</p> <p>If the display is in UPDATEON or UPDATEREADY state, it might not change power states after receiving the command.</p>	<p>powerstate=[Value] Where [Value] is one of the following:</p> <ul style="list-style-type: none">• on• ready• standby• update

Input commands

Get command	Set command	Response
get input	set input[Value] Where [Value] is one of the following: <ul style="list-style-type: none"> • =hdmi1 • =hdmi2 • =hdmi3 • =hdmi4 • =vga1 • =ops1 • =usb1 • =android 	input=[Value] Where [Value] is one of the following: <ul style="list-style-type: none"> • hdmi1 • hdmi2 • hdmi3 • hdmi4 • vga1 • ops1 • usb1 • android • none

Brightness commands

Get command	Set command	Response
get brightness	set brightness[Value] Where [Value] is one of the following: <ul style="list-style-type: none"> • +[Value] • -[Value] • =[5-100] 	brightness=[Value] Where [Value] is a number between 5 and 100

Freeze commands

Get command	Set command	Response
get videofreeze	set videofreeze[Value] Where [Value] is one of the following: <ul style="list-style-type: none"> • =on • =off 	videofreeze=[Value] Where [Value] is one of the following: <ul style="list-style-type: none"> • on • off

Screen shade commands

Get command	Set command	Response
get screenshade	set screenshade[Value] Where [Value] is one of the following: <ul style="list-style-type: none">• =on• =off	screenshade=[Value] Where [Value] is one of the following: <ul style="list-style-type: none">• on• off

Volume commands

Get command	Set command	Response
get volume	set volume[Value] Where [Value] is one of the following: <ul style="list-style-type: none">• +[Value]• -[Value]• =[0-100]	volume=[Value] Where [Value] is a number between 0 and 100

Mute commands

Get command	Set command	Response
get mute	set mute[Value] Where [Value] is one of the following: <ul style="list-style-type: none">• =on• =off	mute=[Value] Where [Value] is one of the following: <ul style="list-style-type: none">• on• off

Firmware version commands

Get command	Response
get fwversion	fwversion=[Value] Where [Value] is the firmware version.

Serial number commands

Get command	Response
get serialnum	serialnum=[<i>Value</i>] Where [<i>Value</i>] is the serial number.

Part number commands

Get command	Response
get partnum	partnum=[<i>Value</i>] Where [<i>Value</i>] is the part number, including the revision.

Asynchronous state reporting commands

Get command	Set command	Response
get statereporting	set statereporting[<i>Value</i>] Where [<i>Value</i>] is one of the following: <ul style="list-style-type: none">• =on• =off	statereporting=[<i>Value</i>] Where [<i>Value</i>] is one of the following: <ul style="list-style-type: none">• on• off

Factory reset commands

Set command	Response
set factoryreset=[<i>Value</i>] Where [<i>Value</i>] is the serial number.	factoryreset=[<i>Value</i>] Where [<i>Value</i>] is the serial number.

Resolving issues with managing the display using RS-232

The following table presents common issues with managing the display using RS-232 and explains how to resolve them:

Symptom	Troubleshooting steps
Managing the display using RS-232 isn't working as expected.	<ul style="list-style-type: none">• Make sure all the cable connections are secure.• Restart the display and the remote management system. See <i>Turning off, turning on, and resetting the display</i> on page 48.• Configure the serial interface settings. See <i>Configuring the computer's serial interface settings</i> on page 72.
You're experiencing other issues with managing the display using RS-232, or the previous steps don't resolve the issue.	See <i>Chapter 5: Troubleshooting</i> on page 54.

Appendix C

Hardware environmental compliance

SMART Technologies supports global efforts to ensure that electronic equipment is manufactured, sold and disposed of in a safe and environmentally friendly manner.

Waste Electrical and Electronic Equipment (WEEE)

Electrical and electronic equipment and batteries contain substances that can be harmful to the environment and to human health. The crossed-out wheeled bin symbol indicates that products should be disposed of in the appropriate recycling stream and not as regular waste.



Batteries

The product contains a CR1220 coin cell battery. The remote contains two AAA batteries. Recycle or dispose of batteries properly.

Perchlorate material

The coin cell battery contains perchlorate material. Special handling may apply. See dtsc.ca.gov/hazardouswaste/perchlorate.

More information

See smarttech.com/compliance for more information.

SMART TECHNOLOGIES

smarttech.com/support

smarttech.com/contactsupport

smarttech.com/kb/171538