

visual engineering  
**LIGHTWARE**

**User's Manual**



**HDMI20-OPTC-TX220-PRO, -RX220-PRO**  
**HDMI20-OPTC-TX220-FOX, -RX220-FOX**  
**HDMI20-OPTC-TX220-NTQ, -RX220-NTQ**  
**HDMI20-OPTC-TX220-PCN, -RX220-PCN**

Multimode Single Fiber Optical Extender

## Important Safety Instructions

### Class I apparatus construction

This equipment must be used with a mains power system with a protective earth connection. The third (earth) pin is a safety feature, do not bypass or disable it. The equipment should be operated only from the power source indicated on the product.

To disconnect the equipment safely from power, remove the power cord from the rear of the equipment, or from the power source. The MAINS plug is used as the disconnect device, the disconnect device shall remain readily operable.

There are no user-serviceable parts inside of the unit. Removal of the cover will expose dangerous voltages. To avoid personal injury, do not remove the cover. Do not operate the unit without the cover installed.

The appliance must be safely connected to multimedia systems. Follow instructions described in this manual.

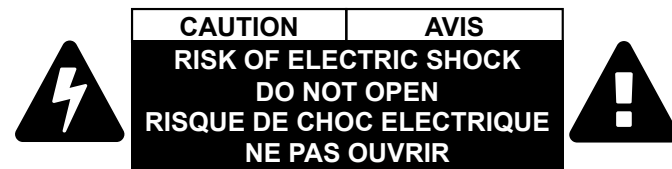

### Ventilation

For the correct ventilation and to avoid overheating ensure enough free space around the appliance. Do not cover the appliance, let the ventilation holes free and never block or bypass the ventilators (if any).

### WARNING

To prevent injury, the apparatus is recommended to securely attach to the floor/wall or mount in accordance with the installation instructions. The apparatus shall not be exposed to dripping or splashing and that no objects filled with liquids, such as vases, shall be placed on the apparatus. No naked flame sources, such as lighted candles, should be placed on the apparatus.

## Waste Electrical & Electronic Equipment WEEE

This marking shown on the product or its literature, indicates that it should not be disposed with other household wastes at the end of its working life. To prevent possible harm to the environment or human health from uncontrolled waste disposal, please separate this from other types of wastes and recycle it responsibly to promote the sustainable reuse of material resources. Household users should contact either the retailer where they purchased this product, or their local government office, for details of where and how they can take this item for environmentally safe recycling. Business users should contact their supplier and check the terms and conditions of the purchase contract. This product should not be mixed with other commercial wastes for disposal.



### Caution for the Receiver (RX): Laser product



### Caution for the Transmitter (TX): Laser product



## Common Safety Symbols

Symbol	Description
	Alternating current
	Protective conductor terminal
	Caution, possibility of electric shock
	Caution
	Laser radiation

## Symbol Legend

The following symbols and markings are used in the document:

**WARNING!** Safety-related information which is highly recommended to read and keep in every case!

**ATTENTION!** Useful information to perform a successful procedure; it is recommended to read.

**INFO:** A notice which contains additional information. Procedure can be successful without reading it.

**DEFINITION:** The short description of a feature or a function.

**TIPS AND TRICKS:** Ideas which you may have not known yet but can be useful.

## Navigation Buttons

 Go back to the previous page. If you clicked on a link previously, you can go back to the source page by clicking the button.

 Navigate to the Table of Contents.

 Step back one page.

 Step forward to the next page.

## Document Information

All presented functions refer to the indicated products. The descriptions have been made during testing these functions in accordance with the indicated Hardware/Firmware/Software environment:

Item	Version
Lightware Device Controller (LDC) software	1.26.1
Lightware Device Updater2 Software	1.2.2
Controller firmware	1.2.0
Hardware	1.2

Document revision: **1.3**

Release date: 25-03-2020

Editor: Laszlo Zsedenyi, Judit Barsony

## About Printing

Lightware Visual Engineering supports green technologies and eco-friendly mentality. Thus, this document is made for digital usage primarily. If you need to print out few pages for any reason, follow the recommended printing settings:

- Page size: A4
- Output size: Fit to page or Match page size
- Orientation: Landscape

**TIPS AND TRICKS:** Thanks to the size of the original page, the border around the content (grey on the second picture below) makes possible to organize the pages better. After punching the printed pages, they can be placed easily into a ring folder.

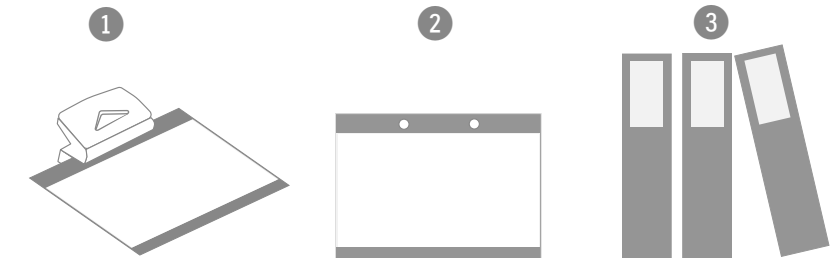

## Table of Contents

<b>1. INTRODUCTION</b> .....	<b>6</b>	<b>4. OPERATION</b> .....	<b>22</b>	<b>5.9. SETTINGS MENU</b> .....	<b>39</b>
1.1. DESCRIPTION.....	6	4.1. POWERING ON.....	22	5.9.1. Status Tab.....	39
1.2. BOX CONTENTS.....	6	4.2. FRONT PANEL OPERATIONS.....	22	5.9.2. Network Tab.....	39
1.3. COMPATIBLE DEVICES.....	6	4.2.1. Function Button - Transmitter.....	23	5.9.3. Front Panel Tab.....	39
1.4. MODEL DENOMINATION.....	6	4.2.2. Function Button - Receiver.....	23	5.9.4. Backup Tab (Configuration Cloning).....	40
1.5. ABOUT THE SERIAL NUMBER.....	6	4.2.3. Boot Button.....	23	5.9.5. System.....	41
1.6. FEATURES OF THE DEVICE.....	7	4.3. FRONT PANEL LCD MENU OPERATIONS.....	24	<b>5.10. ADVANCED VIEW WINDOW</b> .....	<b>41</b>
1.7. MODEL COMPARISON.....	8	4.3.1. System Settings Menu.....	24	<b>6. LW3 PROGRAMMERS' REFERENCE</b> .....	<b>42</b>
1.8. TYPICAL APPLICATION.....	8	4.3.2. Ports Menu.....	25	<b>6.1. OVERVIEW</b> .....	<b>42</b>
1.8.1. Integrated System Application.....	8	4.3.3. EDID Menu.....	25	<b>6.2. PROTOCOL RULES</b> .....	<b>42</b>
1.8.2. Standalone Application.....	9	4.3.4. Health Menu.....	26	6.2.1. LW3 Tree Structure and Command Structure (examples).....	42
<b>2. INSTALLATION</b> .....	<b>10</b>	4.3.5. Remote Menu.....	26	6.2.2. General Rules.....	42
<b>2.1. MOUNTING OPTIONS</b> .....	<b>10</b>	<b>5. SOFTWARE CONTROL – LIGHTWARE DEVICE CONTROLLER</b> ...27		6.2.3. Command Types.....	43
2.1.1. Truss Mounting - Receiver.....	10	<b>5.1. INSTALL AND UPGRADE</b> .....	<b>27</b>	6.2.4. Prefix Summary.....	43
2.1.2. Standard Rack Installation.....	10	<b>5.2. RUNNING THE LDC</b> .....	<b>27</b>	6.2.5. Error Messages.....	43
<b>2.2. CONNECTING STEPS</b> .....	<b>12</b>	<b>5.3. ESTABLISHING THE CONNECTION</b> .....	<b>28</b>	6.2.6. Escaping.....	43
<b>3. PRODUCT OVERVIEW</b> .....	<b>13</b>	<b>5.4. CROSSPOINT MENU - HDMI20-OPTC-TX220-PRO</b> .....	<b>29</b>	6.2.7. Signature.....	44
<b>3.1. FRONT VIEW</b> .....	<b>13</b>	<b>5.5. PORT PROPERTIES WINDOW</b> .....	<b>30</b>	6.2.8. Subscription.....	44
<b>3.2. REAR VIEW - TRANSMITTERS</b> .....	<b>14</b>	5.5.1. HDMI Input Port -Transmitter.....	30	6.2.9. Notifications about the Changes of the Properties.....	44
<b>3.3. REAR VIEW - RECEIVERS</b> .....	<b>15</b>	5.5.2. HDMI Output Port - Transmitter.....	30	6.2.10. Legend for the Control Commands.....	44
<b>3.4. ELECTRICAL CONNECTIONS</b> .....	<b>16</b>	5.5.3. Optical Input Port - Receiver.....	31	<b>6.3. SYSTEM COMMANDS</b> .....	<b>45</b>
3.4.1. Power Connectors.....	16	5.5.4. HDMI Output Port - Receiver.....	31	6.3.1. Querying the Product Name.....	45
3.4.2. Optical Connectors.....	16	<b>5.6. EDID MENU</b> .....	<b>32</b>	6.3.2. Setting the Device Label.....	45
3.4.3. HDMI Input and Output Ports.....	16	5.6.1. Sources and Destinations.....	32	6.3.3. Querying the Serial Number.....	45
3.4.4. Ethernet (LAN) Port.....	16	5.6.2. EDID Operations.....	32	6.3.4. Querying the Firmware Version.....	45
3.4.5. USB Connector.....	17	5.6.3. EDID Summary Window.....	33	6.3.5. Resetting the Extender.....	45
3.4.6. RS-232 Port.....	17	5.6.4. Editing an EDID.....	33	6.3.6. Restoring the Factory Default Settings.....	45
<b>3.5. MULTIMODE SINGLE FIBER EXTENDER CONCEPT</b> .....	<b>17</b>	5.6.5. Creating an EDID.....	34	6.3.7. Locking Front Panel.....	46
3.5.1. Summary of Interfaces - Transmitter.....	17	<b>5.7. CONTROL MENU</b> .....	<b>34</b>	6.3.8. Enabling Dark Mode.....	46
3.5.2. Summary of Interfaces - Receiver.....	17	5.7.1. RS-232 Tab.....	34	6.3.9. Setting the Dark Mode Delay.....	46
<b>3.6. OPTICAL INTERFACE</b> .....	<b>18</b>	5.7.2. Ethernet Tab.....	35	6.3.10. Setting the Dark Mode on the Remote Device.....	46
<b>3.7. VIDEO AND AUDIO INTERFACE</b> .....	<b>19</b>	<b>5.8. EVENT MANAGER</b> .....	<b>35</b>	6.3.11. Setting the Rotary Direction of the Jog Dial Knob.....	46
3.7.1. Output Conversion Modes.....	19	5.8.1. The Event Editor.....	36		
3.7.2. Autoselect Feature.....	19	5.8.2. Create or Modify an Event.....	36		
<b>3.8. CONTROL FEATURES</b> .....	<b>20</b>	5.8.3. Special Tools and Accessories.....	38		
3.8.1. USB Control Interface.....	20	5.8.4. Clear One or More Event(s).....	38		
3.8.2. Ethernet Interface.....	20	5.8.5. Export and Import Events.....	38		
3.8.3. Serial Interface.....	21				

<b>6.4. VIDEO PORT AND CROSSPOINT SETTINGS.....</b>	<b>47</b>	<b>7. FIRMWARE UPGRADE.....</b>	<b>59</b>
6.4.1. Querying the Crosspoint Setting.....	47	7.1. BACKWARD COMPATIBILITY.....	59
6.4.2. Switching Video Input.....	47	7.2. ABOUT THE FIRMWARE PACKAGE (LFP2 FILE).....	59
6.4.3. Muting Input Port.....	47	7.3. INSTALLATION.....	59
6.4.4. Unmuting Input Port.....	47	7.4. FIRMWARE UPGRADING STEPS.....	60
6.4.5. Locking Input Port.....	47	7.5. KEEPING THE CONFIGURATION SETTINGS.....	61
6.4.6. Unlocking Input Port.....	47	<b>8. TROUBLESHOOTING.....</b>	<b>62</b>
6.4.7. HDCP Setting.....	47	<b>9. TECHNOLOGIES.....</b>	<b>64</b>
6.4.8. Querying the Status of Source Ports.....	48	9.1. EDID MANAGEMENT.....	64
6.4.9. Querying the Status of Destination Ports.....	49	9.1.1. Understanding the EDID.....	64
6.4.10. Querying the Video Autoselect Settings.....	49	9.1.2. Advanced EDID Management.....	64
6.4.11. Changing the Autoselect Mode.....	49	9.2. HDCP MANAGEMENT.....	65
6.4.12. Setting the Output Conversion Mode.....	49	9.2.1. Protected and Unprotected Content.....	65
6.4.13. Setting the Output Conversion Mode of the Remote Device.....	50	9.2.2. Disable Unnecessary Encryption.....	65
<b>6.5. NETWORK CONFIGURATION.....</b>	<b>50</b>	9.3. PIXEL ACCURATE RECLOCKING.....	66
6.5.1. Querying the IP Address.....	50	9.4. SERIAL MANAGEMENT.....	67
6.5.2. Changing the IP Address (Static).....	50	9.4.1. General Information.....	67
6.5.3. Querying the Subnet Mask.....	50	9.4.2. Types of Serial Cables.....	67
6.5.4. Changing the Subnet Mask (Static).....	50	9.4.3. RS-232 Signal Transmission over Lightware Extender Devices ..	67
6.5.5. Querying the Gateway Address.....	50	<b>10. APPENDIX.....</b>	<b>68</b>
6.5.6. Changing the Gateway Address (Static).....	50	10.1. SPECIFICATION.....	68
6.5.7. Querying the DHCP State.....	51	10.2. MAXIMUM EXTENSION DISTANCES.....	69
6.5.8. Changing the DHCP State.....	51	10.3. CONTENT OF BACKUP FILE.....	70
6.5.9. Enabling Ethernet Port.....	51	10.4. FACTORY DEFAULT SETTINGS.....	70
<b>6.6. RS-232 PORT CONFIGURATION.....</b>	<b>51</b>	10.5. FACTORY EDID LIST.....	72
6.6.1. Querying the RS-232 Operation Mode.....	51	10.6. MECHANICAL DRAWINGS.....	73
6.6.2. Setting the RS-232 Operation Mode.....	51	10.6.1. Transmitter.....	73
6.6.3. Setting the BAUD Rate.....	51	10.6.2. Receiver.....	73
6.6.4. Setting the Databit.....	52	<b>10.7. FURTHER INFORMATION.....</b>	<b>74</b>
6.6.5. Setting the Stopbits.....	52		
6.6.6. Setting the Parity.....	52		
6.6.7. Enabling Command Injection Mode.....	52		
<b>6.7. SENDING MESSAGE VIA THE COMMUNICATION PORTS.....</b>	<b>53</b>		
6.7.1. Sending Message via an RS-232 Port.....	53		
6.7.2. Sending Message via TCP Port.....	53		
6.7.3. Sending Message via UDP Port.....	54		
<b>6.8. EDID MANAGEMENT.....</b>	<b>55</b>		
6.8.1. Querying the Emulated EDIDs.....	55		
6.8.2. Querying the Validity of a Dynamic EDID.....	55		
6.8.3. Querying the Preferred Resolution of an User EDID.....	55		
6.8.4. Emulating an EDID to an Input Port.....	55		
6.8.5. Copying an EDID to User Memory.....	56		
6.8.6. Deleting an EDID from User Memory.....	56		
6.8.7. Resetting the Emulated EDIDs.....	56		
<b>6.9. LW3 COMMANDS - QUICK SUMMARY.....</b>	<b>57</b>		

# 1

## Introduction

Thank you for choosing Lightware's HDMI20-OPTC series device. In the first chapter we would like to introduce the device highlighting the most important features in the below listed sections:

- ▶ DESCRIPTION
- ▶ BOX CONTENTS
- ▶ COMPATIBLE DEVICES
- ▶ MODEL DENOMINATION
- ▶ ABOUT THE SERIAL NUMBER
- ▶ FEATURES OF THE DEVICE
- ▶ MODEL COMPARISON
- ▶ TYPICAL APPLICATION

### 1.1. Description

Thank you for choosing Lightware HDMI20-OPTC series products.

The HDMI20-OPTC series extenders are HDMI 2.0 compatible extender pair for video, RS-232 and Gigabit Ethernet signals, supporting uncompressed 4K UHD resolution at 60Hz 4:4:4. This extender pair is particularly recommended for rental and staging applications, 4K live events, and for future-proof operation centers. The extender can transmit HDMI 2.0 signals with 18Gbps over one multimode fiber to a distance of up to 700 meters.

Using the factory, custom or transparent EDID emulation the user can fix and lock EDID data on the HDMI connector. Advanced EDID Management forces the required resolution from any video source and fixes the output format conforming to the system requirements. The unit offers bi-directional and transparent RS-232 transmission and two separate Gigabit Ethernet signals over the fiber connection.

All devices can be mounted on a rack shelf or used standalone, rack ears also serve easy handling and bump protection, mounting threads on top and one of the sides to conform strict installation safety regulations.

### 1.2. Box Contents

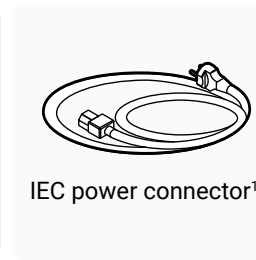
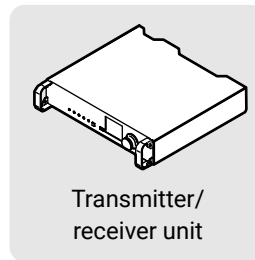

<sup>1</sup> For HDMI20-OPTC-TX220-PRO, -RX220-PRO, HDMI20-OPTC-TX220-FOX, -RX220-FOX, HDMI20-OPTC-TX220-NTQ, -RX220-NTQ models.

<sup>2</sup> For HDMI20-OPTC-TX220-PCN, -RX220-PCN models.

### 1.3. Compatible Devices

HDMI20-OPTC series devices are compatible with each other. For more information, please check the compatibility table on [www.lightware.com](http://www.lightware.com).

### 1.4. Model Denomination

HDMI20-OPTC-TX220-PRO

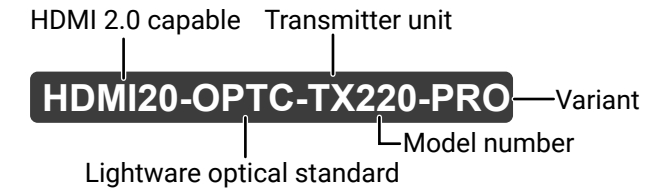

HDMI20-OPTC-RX220-PRO

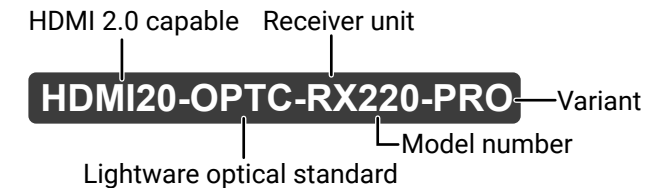

### 1.5. About the Serial Number

Lightware devices contain a label indicating the unique serial number of the product. The structure is the following:

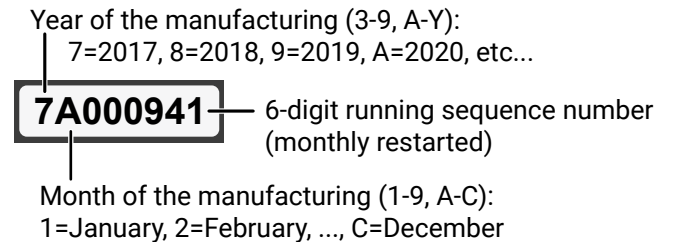

## 1.6. Features of the Device



### 4K Video without Compression

Supporting uncompressed 4K UHD resolution at 60Hz 4:4:4 colorspace.



### Signal Transmission up to 700m

Video, audio, Ethernet, RS-232 signal over fiber.



### 18 Gbit/sec Bandwidth

The extender can transmit HDMI 2.0 signals with 18Gbps.

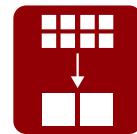

### Conversion to 4:2:0

The receiver is able to subsample the video stream in YCbCr colorspace from 4:4:4 to 4:2:0.



### HDMI 2.0 to 2x HDMI 1.4 Splitting

The device supports left and right column processing of an HDMI 2.0 4K@60Hz 4:4:4 input signal, allowing for the transmission of an 18 Gbps HDMI 2.0 signal over two HDMI 1.4 compliant links. The two halves can then be recombined at the signal destination.

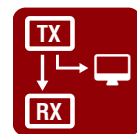

### Local Output

User can attach a local monitor to observe the video signal sent through the fiber optical cable. The resolution and clock frequency are the same on HDMI and fiber optical connectors, no internal scaling or conversion is applied.



### Graphic Display and Rotary Jog Dial Control Knob

Easy setting and menu navigation are assured by the color graphic display and the comfortable jog dial control.



### Dark Mode

Rental application requires this function, which keeps the LEDs unlit to hide the device during the event.



### Event Manager

The Event Manager tool takes care of all the necessary control in a smaller configuration by performing predefined actions in response to device status changes. Hence, in a less complex environment, there is no need to invest in additional control solutions, which makes the receiver the best choice for numerous applications.



### Mounting Threads

Mounting threads on top and one of the sides to conform strict installation safety regulations.

### 1.7. Model Comparison

Model name	Power connector	Optical Connector	Video Port	Ethernet port	Serial port	USB port
HDMI20-OPTC-TX220-PRO, -RX220-PRO	Standard IEC (C14 type)	Neutrik opticalCON DUO	HDMI	Neutrik etherCON	D-SUB	USB mini B
HDMI20-OPTC-TX220-FOX, -RX220-FOX		Fiberfox				
HDMI20-OPTC-TX220-NTQ, -RX220-NTQ		Neutrik opticalCON QUAD				
HDMI20-OPTC-TX220-PCN, -RX220-PCN	Neutrik powerCON TRUE 1	Neutrik opticalCON DUO				

### 1.8. Typical Application

- Rental and staging
- Long distance lossless HDMI or DVI signal transmission
- Professional AV systems, conference rooms

#### 1.8.1. Integrated System Application

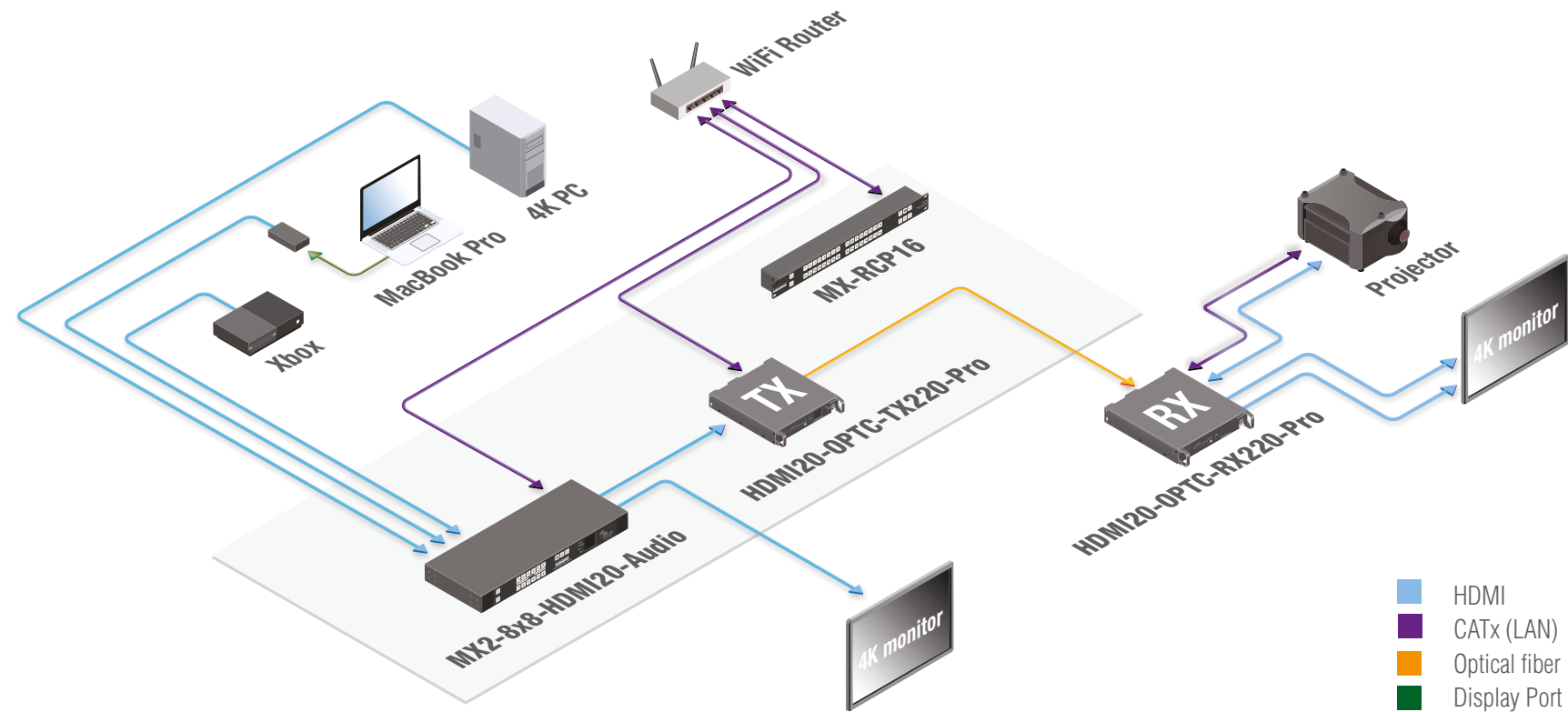



## 1.8.2. Standalone Application

### Typical Application Description

The two Ethernet connectors on each extender make possible to daisy chain the devices and build a local network where all the transmitters (1..3) and receivers (1..3) are available via LAN.

They can be controlled by Lightware Device Controller (LDC) software from the laptop. Optical fiber cable transmits the HDMI, embedded audio, Ethernet, and RS-232 signal to the receivers, so in this case, the sinks can be controlled by Ethernet commands from the control device (laptop).

In this example, all the sources send HDMI 2.0 4K@60Hz 4:4:4 A/V signal to the transmitters which extend the stream to the receivers via multimode fiber cable.

Receiver 1..3 represent three applications of the output modes:

- RX1 is in **transparent mode** (no conversion mode), the sinks are stacked projectors. The video signal is HDMI 2.0 4K@60Hz 4:4:4 on the Output 1A and the Output 2 ports.
- RX2 is in **downsample convert mode** (convert to YCbCr 4:2:0). The LED screen 2 is 4K compatible and connected to the Output 2 port. LED screen 1 is not HDMI 2.0 4K@60Hz 4:4:4 compliant, so the video processor in the receiver converts the HDMI signal from 4:4:4 to 4:2:0, and this way the sink will be able to accept the signal on the Output 1B.
- RX3 is in **split mode**. The receiver supports vertical splitting of the HDMI 2.0 4K@60Hz 4:4:4 input signal to left and right halves allowing for the transmission of a 18Gbps HDMI 2.0 signal over two HDMI1.4 compliant links. The sink is a projector which is able to recombine two half signals. Video signal is transmitted to the Output 2 without any changing.

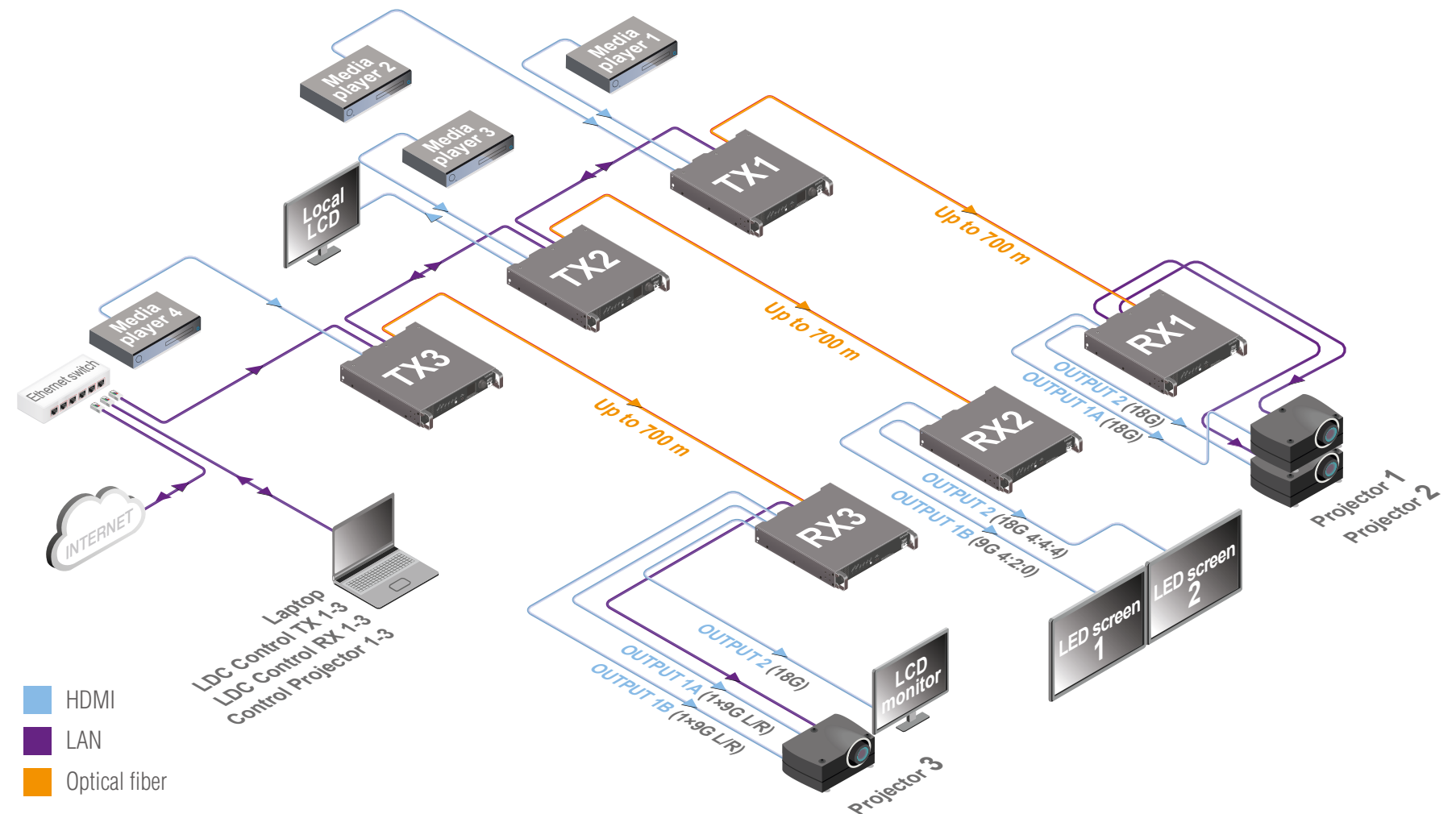

# 2

## Installation

The chapter is about the installation of the device and connecting to other appliances, presenting also the mounting options and further assembly steps:

- ▶ MOUNTING OPTIONS
- ▶ CONNECTING STEPS

### 2.1. Mounting Options

Extenders can mount in several ways, depending on the application. They can be mounted into the rack in pairs, receivers can be used standalone. Rack ears also serve easy handling and bump protection, mounting threads on top and one of the sides to conform strict installation safety regulations.

**ATTENTION!** To ensure the correct ventilation and avoid overheating let enough free space in front of the appliance and keep the ventilation holes free.

#### 2.1.1. Truss Mounting - Receiver

Mounting thread on top and on one of the sides for safe and secure installation. Rigging the handles with a safety wire rope is highly recommended for safety reasons.

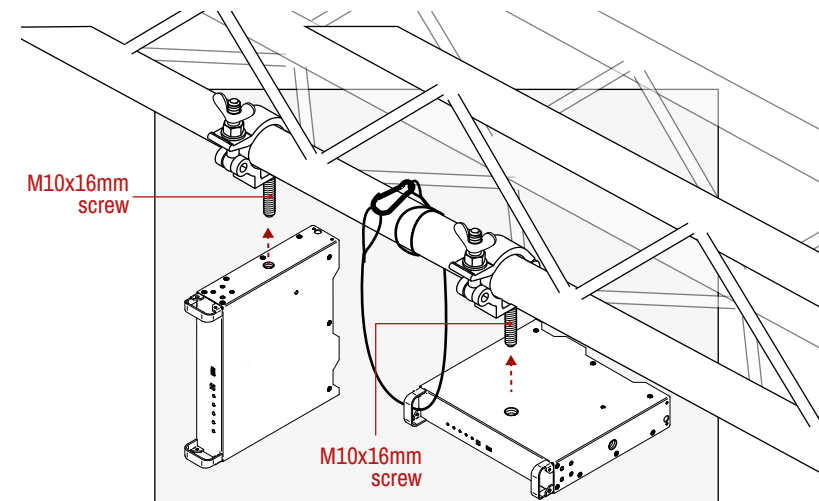

To order mounting accessories please contact [sales@lightware.com](mailto:sales@lightware.com). (Truss clamp and safety wire rope are not available at sales.)

#### 2.1.2. Standard Rack Installation

Rack mounting kit includes all necessary accessories for [Standard Rack Installation](#):

- 2 pcs. rack ears,
- 12 pcs. black, M4x8mm hexagon socket countersunk head screws.

Rack mounting kit is not supplied with the product, it can be purchased separately, please contact [sales@lightware.com](mailto:sales@lightware.com).

**Step 1.** Take two devices directly each other.

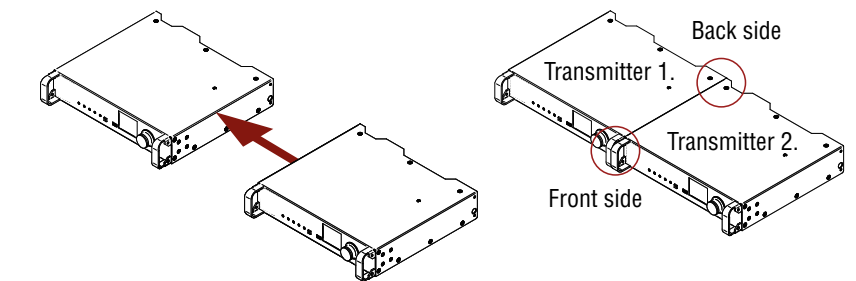

**Step 2.** Two mounting holes on the front ears and two on the back of the chassis is for fastening the two units to each other with 2x 2 pcs. M4x8 mm screws. This way you get a one-rack wide and 1U high device.

**Front side**

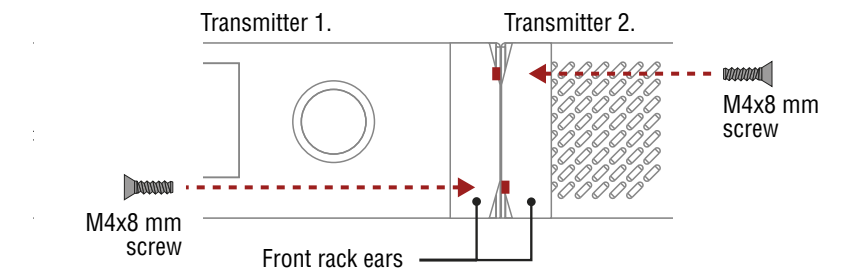

**Back side**

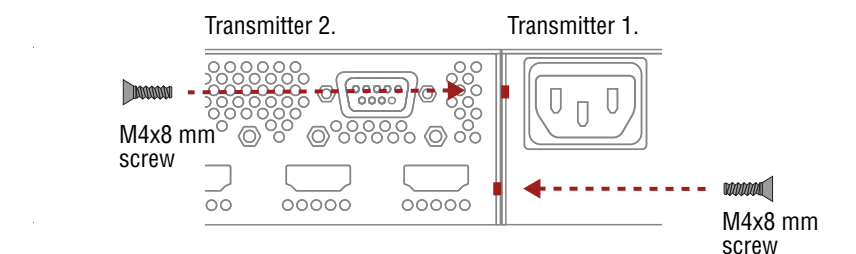

**ATTENTION!** Take care of the mounting direction of the screws!

**Front side**

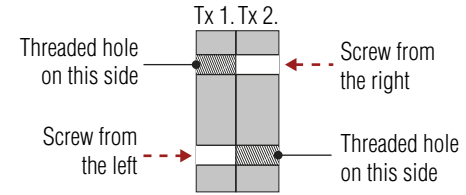

**Back side**

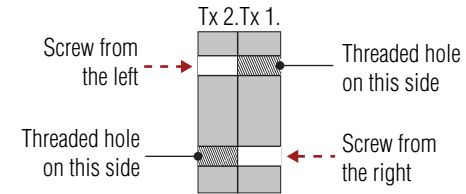

**Mounting direction of the screws**

**Step 3.** Take the rack ears on the left and right side of the extender pair as shown in the picture. Insert the screws into the holes and fix the front ears to the devices.

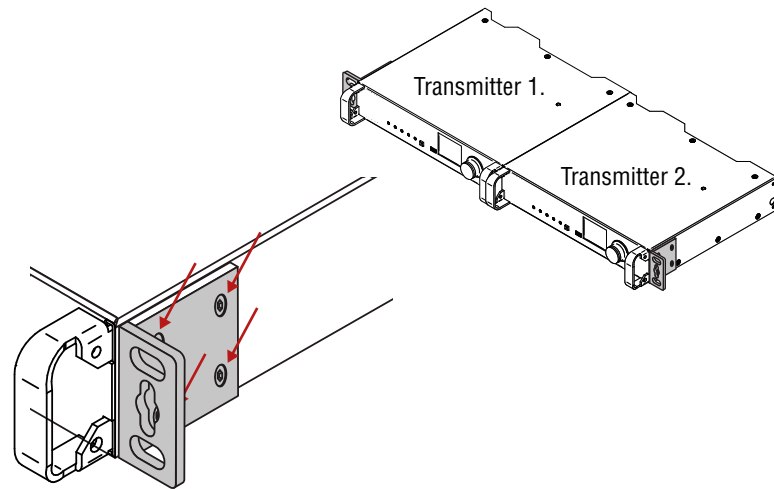

**Assembly of the mounting ears**

**Step 4.** As a final step, mount the unit in the rack.

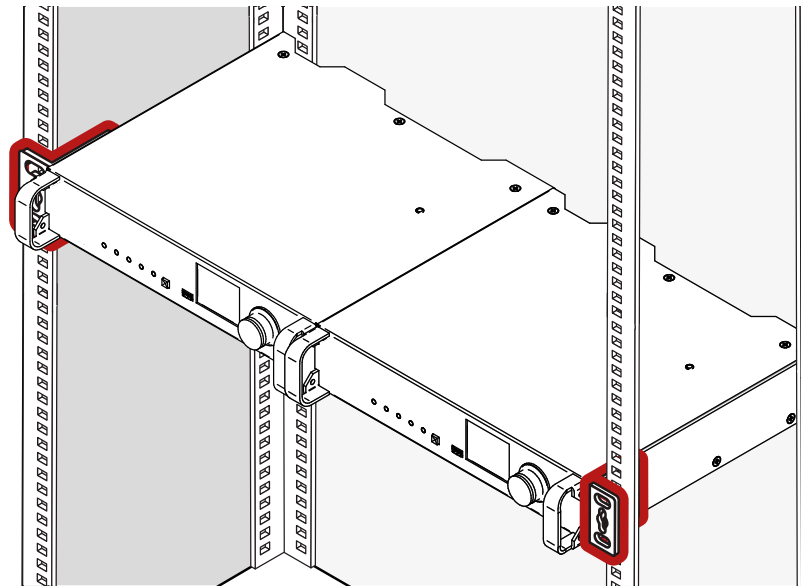

**Standard rack installation**

**ATTENTION!** Always use all the four screws for fixing the rack ears to the rack rail. Choose properly sized screws for mounting. Keep minimum two thread left after the nut screw.

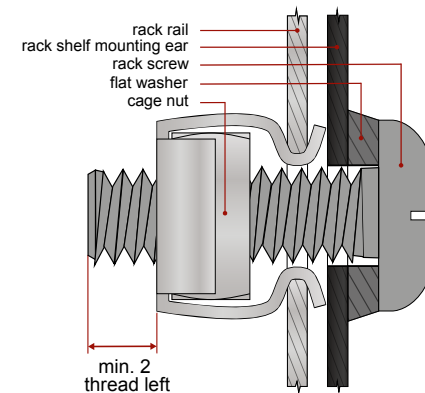

**Mounting the rack ears to the rack rail**

## 2.2. Connecting Steps

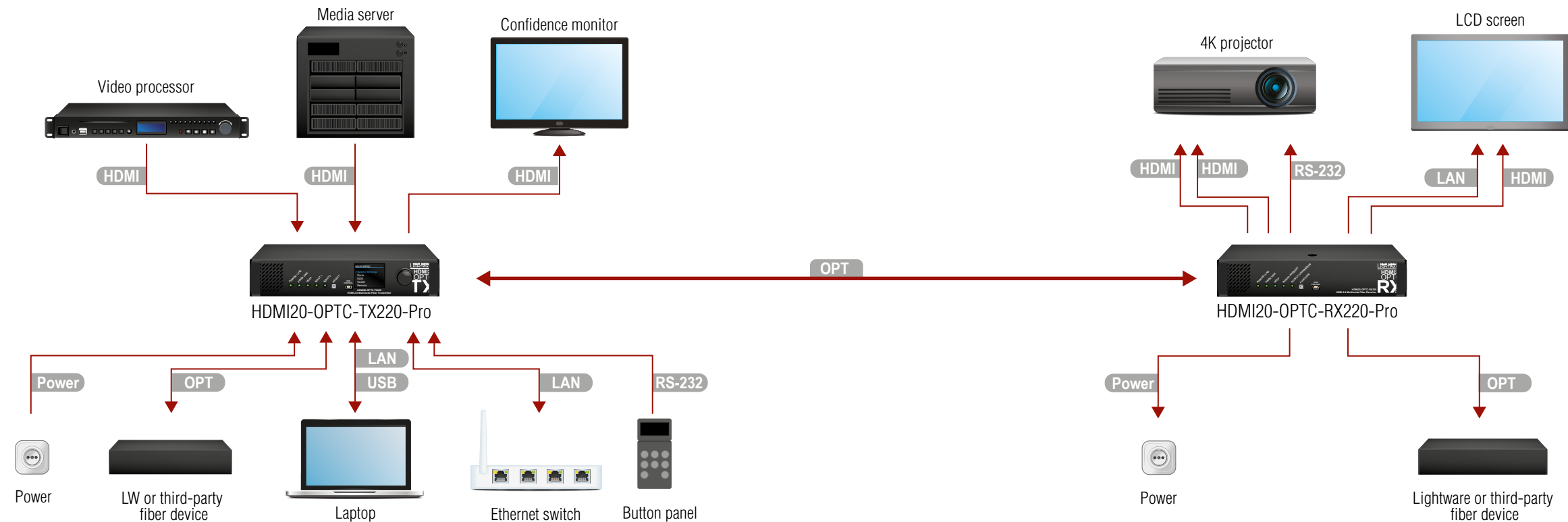

- OPT** Connect a multimode (MM) fiber cable to the channel A of the transmitter.
- OPT** Optionally connect a compatible Lightware device or a third-party device to the break-out LC connector. It is internally linked to the channel B of the Neutrik connector.
- HDMI** Connect an HDMI source (e.g. video processor or media server) to any of the inputs of the transmitter.
- HDMI** Optionally connect an HDMI sink (e.g. confidence monitor) to the HDMI output of the transmitter. The displayed signal of the output port is equal to the extended video signal.
- LAN** Optionally connect Ethernet devices (e.g. switch, laptop, computer etc.) to the available Neutrik etherCON connector(s) of the extender(s). All connected devices will work as if they are connected to the same network. Ethernet connectors are not Power over Ethernet (PoE) compatible.
- USB** Optionally connect a USB mini-B type cable between the transmitter unit and the computer in order to control the device (in this case only the transmitter).
- RS-232** Optionally for RS-232 extension: connect a controller unit (e.g. button panel) to the RS-232 port of the transmitter with a null modem serial cable.
- Power** Connect the power cord to the AC power socket to the transmitter unit. It is recommended to power on the devices as the final step.

- OPT** Connect a multimode (MM) fiber cable to the channel B of the receiver.
- OPT** Optionally connect a compatible Lightware device or a third-party device to the break-out LC connector. It is internally linked to the channel A of Neutrik connector.
- HDMI** Connect an HDMI sink (e.g. 4K projector) to the HDMI 1A and the 1B output ports and the other sink (e.g. LCD screen) to the HDMI 2 output port.
- LAN** In order to control, optionally connect Ethernet devices (e.g. 4K LCD screen) to the available Neutrik etherCON connector of the extender.
- RS-232** Optionally for RS-232 extension: connect a controlled device (e.g. projector) to RS-232 port of the receiver with a serial cable.
- Power** Connect the power cord to AC power socket to the receiver unit. It is recommended to power on the devices as the final step.

**ATTENTION!** Connecting the transmitter and receiver to the same LAN beside they are connected to each other via fiber is not recommended. In case of Ethernet loop, the extenders are not available via LAN.

**ATTENTION!** Always use high-quality HDMI cable for connecting the sources with the transmitters, and sinks with the receivers.

# 3

## Product Overview

The following sections are about the physical structure of the device, input/output ports, and connectors:

- ▶ FRONT VIEW
- ▶ REAR VIEW - TRANSMITTERS
- ▶ REAR VIEW - RECEIVERS
- ▶ ELECTRICAL CONNECTIONS
- ▶ MULTIMODE SINGLE FIBER EXTENDER CONCEPT
- ▶ OPTICAL INTERFACE
- ▶ VIDEO AND AUDIO INTERFACE
- ▶ CONTROL FEATURES

### 3.1. Front View

INFO: All models have the same look and controls on the front panel.

#### HDMI20-OPTC-TX220 series

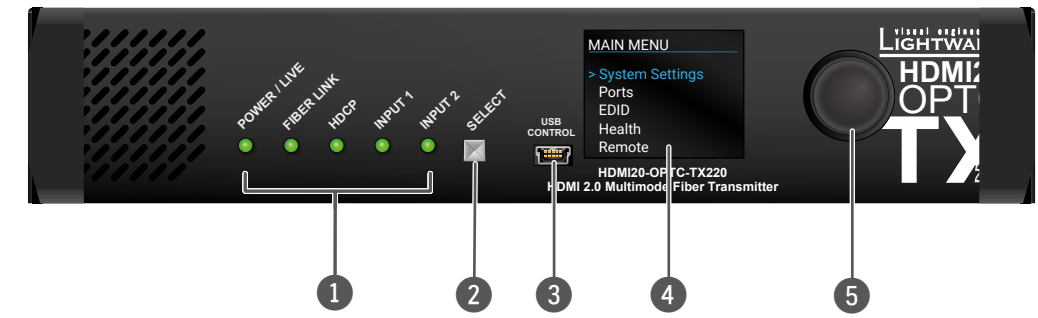

#### HDMI20-OPTC-RX220 series

INFO: All models have the same look and controls on the front panel.

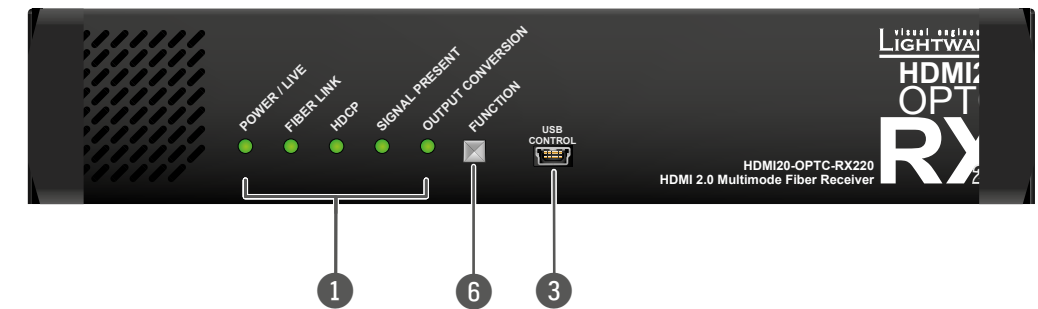

- 1 Status LEDs** The LEDs give feedback about the state, connections and certain settings of the unit. For details, see [Status LEDs - Transmitter](#) and [Status LEDs - Receiver](#) section.
- 2 Select button** **Transmitter:** Select button toggles between the Input 1 and Input 2.
- 6 Function button** **Receiver:** Function button sets the output conversion mode. See the details in [Output Conversion Modes](#) section.
- 3 USB Port** USB mini-B port for local controlling the unit by Lightware Device Controller software.
- 4 LCD display** **Transmitter:** Display of the front panel menu.
- 5 Jog dial knob** **Transmitter:** Browse the menu by turning the knob, click on the desired item to check or change it.

## 3.2. Rear View -Transmitters

### HDMI20-OPTC-TX220-PRO

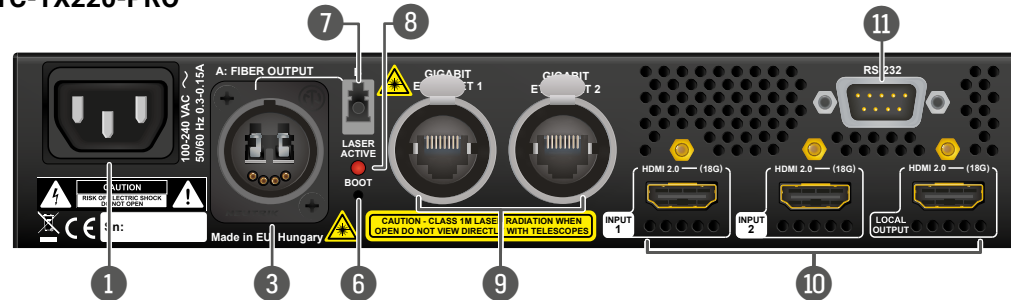

### HDMI20-OPTC-TX220-FOX

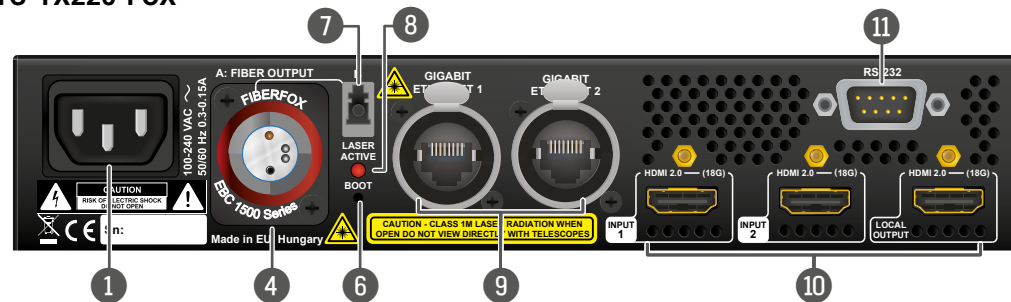

### HDMI20-OPTC-TX220-NTQ

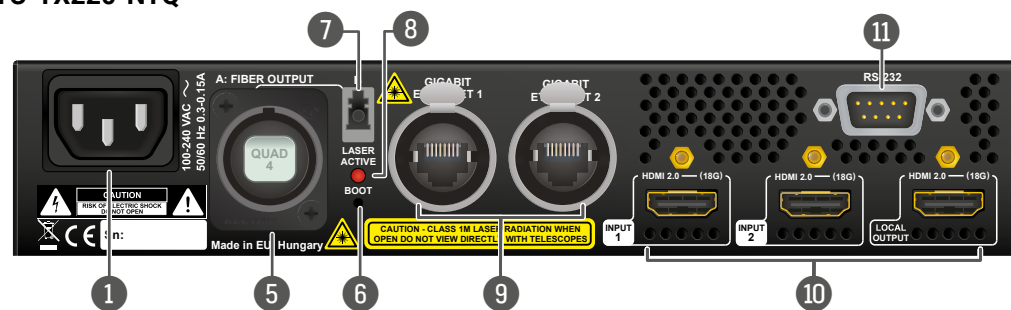

### HDMI20-OPTC-TX220-PCN

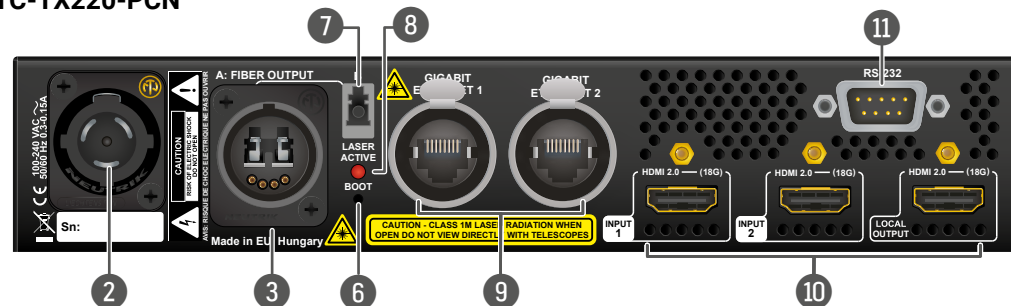

- |  |   |
|--|---|
| <p>1 AC Connector</p> <p>2 AC Connector (PCN)</p> <p>3 Fiber Connector (PRO, PCN)</p> <p>4 Fiber Connector (FOX)</p> <p>5 Fiber Connector (NTQ)</p> <p>6 Boot button</p> <p>7 Break-out connector</p> <p>8 Laser LED</p> <p>9 LAN</p> <p>10 HDMI connector</p> <p>11 Serial port</p> | <p>Standard IEC C14 connector accepting 100-240 V, 50 or 60 Hz.</p> <p>NT POWER CON TRUE 1 connector accepting 100-240 V, 50 or 60 Hz.</p> <p>Fiber connector for optical data transmission. The <b>channel A</b> carries the signal from the transmitter to <b>channel B</b> in the receiver. In <b>HDMI20-OPTC-220-PRO</b> and <b>-PCN</b> models, the fiber connector type is Neutrik opticalCON DUO Connector.</p> <p>In <b>HDMI20-OPTC-220-FOX</b> models, the fiber connector type is Fiberfox Connector.</p> <p>In <b>HDMI20-OPTC-220-NTQ</b> models, the fiber connector type is Neutrik opticalCON QUAD Connector.</p> <p>Hidden button for special bootload function.</p> <p>The break-out LC connector is internally connected to the <b>channel B</b> of Neutrik connector in the transmitter and the <b>channel A</b> in the receiver. It is to carry any optical signal from the break-out LC connector.</p> <p>It gives feedback about the operation of the optical module. When the laser is active (Laser LED is ON), it radiates invisible waves from the optical connector. Avoid eye exposure to beam!</p> <p>Two Neutrik etherCON connectors for Gigabit Ethernet (to control the unit or for pass-through). Both are in the same local network. Remote powering (PoE) is not possible.</p> <p>Two HDMI 2.0 input ports and one HDMI 2.0 output port for local display.</p> <p>D-SUB connector for bidirectional RS-232 communication (control/command injection/pass-through mode).</p> |
|--|---|

INFO: All models have the same functionality, the difference is only the connector types.

### 3.3. Rear View - Receivers

HDMI20-OPTC-RX220-PRO

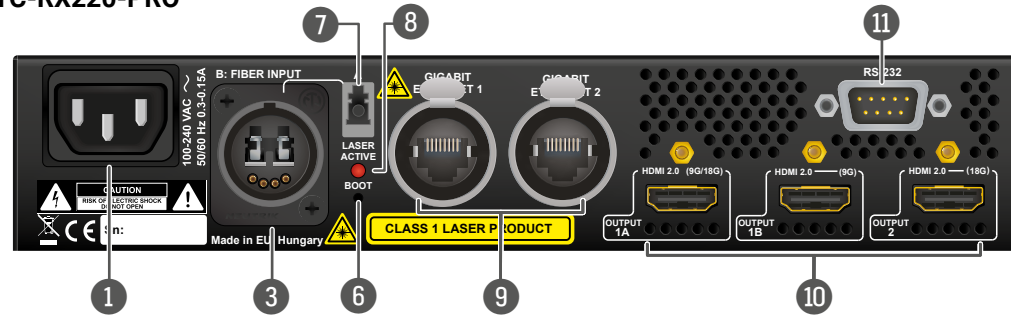

HDMI20-OPTC-RX220-FOX

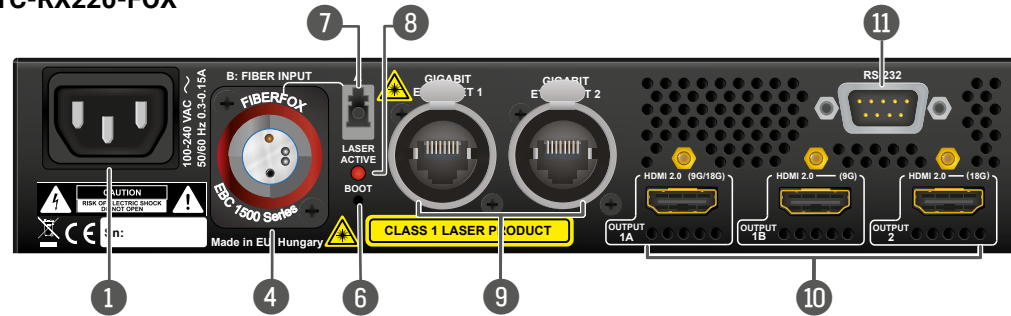

HDMI20-OPTC-RX220-NTQ

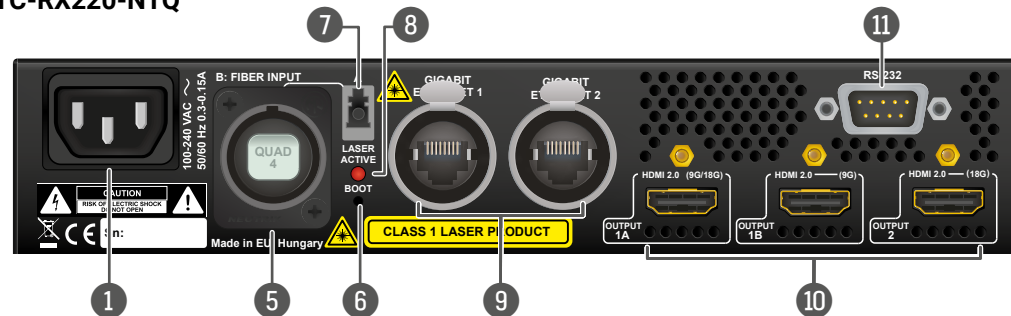

HDMI20-OPTC-RX220-PCN

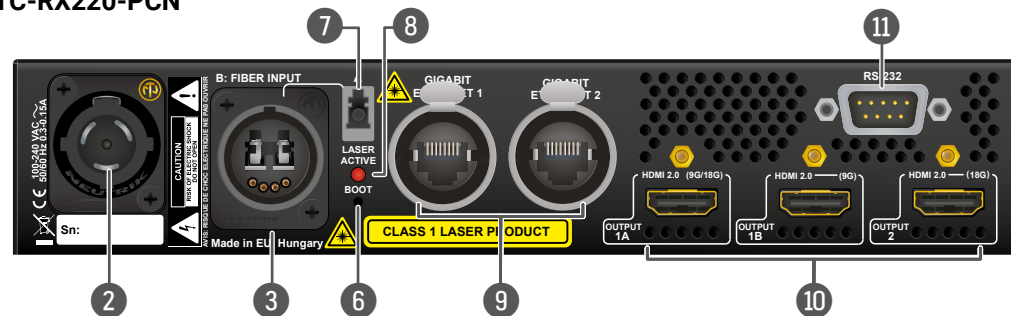

- 1 **AC Connector** Standard IEC C14 connector accepting 100-240 V, 50 or 60 Hz.
- 2 **AC Connector (PCN)** NT powerCON TRUE 1 connector accepting 100-240 V, 50 or 60 Hz.
- 3 **Fiber Connector (PRO, PCN)** Fiber connector for optical data transmission. The **channel A** carries the signal from the transmitter to **channel B** in the receiver. In **HDMI20-OPTC-220-PRO** and **-PCN** models, the fiber connector type is Neutrik opticalCON DUO Connector.
- 4 **Fiber Connector (FOX)** In **HDMI20-OPTC-220-FOX** models, the fiber connector type is Fiberfox.
- 5 **Fiber Connector (NTQ)** In **HDMI20-OPTC-220-NTQ** models, the fiber connector type is Neutrik opticalCON QUAD Connector.
- 6 **Boot button** Hidden button for special bootload function.
- 7 **Break-out connector** The break-out LC connector is internally connected to the **channel B** of Neutrik connector in the transmitter and the **channel A** in the receiver. It is to carry any optical signal from the break-out LC connector.
- 8 **Laser LED** It gives feedback about the operation of the optical module. When the laser is active (Laser LED is ON), it radiates invisible waves from the optical connector. Avoid eye exposure to beam!
- 9 **LAN** Two Neutrik etherCON connectors for Gigabit Ethernet (to control the unit or for pass-through). Both are in the same local network. Remote powering (PoE) is not possible.
- 10 **HDMI connector** Three HDMI video output ports.
- 11 **Serial port** D-SUB connector for bidirectional RS-232 communication (control/command injection/pass-through mode).

INFO: All models have the same functionality, the difference is only the connector types.

### 3.4. Electrical Connections

#### 3.4.1. Power Connectors

HDMI20-OPTC series has AC connectors, accepts 100-240 V, 50 or 60 Hz. Two different power connector type is available:

##### Standard IEC C14 Connector

The HDMI20-OPTC-220-PRO, HDMI20-OPTC-220-FOX, HDMI20-OPTC-220-NTQ series extenders are supplied with IEC C14 power connector.

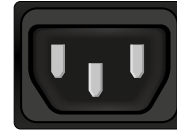

##### Neutrik PowerCON TRUE 1 Connector

The HDMI20-OPTC-220-PCN extenders are supplied with NT PowerCON TRUE 1 Connector (NAC3MPX type).



#### 3.4.2. Optical Connectors

HDMI20-OPTC series extenders transmit the video, embedded audio, Ethernet, and serial signal using multimode 50/125 fiber optical cable.

##### Neutrik OpticalCON Duo Connector

HDMI20-OPTC-220-PRO and HDMI20-OPTC-220-PCN extenders supplied with Neutrik opticalCON connector (NO2-4FDW type LC duplex) and LC ODVA connector have two fiber channels, channel A and channel B. Only one channel is used (from channel A on the transmitter to channel B on the receiver). The copper pins of the Neutrik connector are not in use. Neutrik opticalCON DUO is compatible with 2x LC connector.



##### Fiberfox Connector

HDMI20-OPTC-220-FOX extenders supplied with MINI expanded beam fiber optic Fiberfox connector (EBC-1502 type). It has two fiber channels: channel A and channel B. Only one channel is used (from channel A on the transmitter to channel B on the receiver). The copper pins of the connector are not in use.



##### Neutrik OpticalCON QUAD Connector

HDMI20-OPTC-220-NTQ extenders supplied with Neutrik opticalCON QUAD connector (NO4FDW-A type) with four fiber channel. The sealing cover helps to protect against the dust and dirt.



##### LC Connector

One channel of the Neutrik connector is not used by the extenders for signal transmission and it is internally connected to the LC break-out connector in all models. For more information about break-out connector see [Application Example with Break-out Connector](#) section.



**WARNING! Avoid eye exposure to beam! Direct intrabeam viewing normally hazardous.**

INFO: Fiber optic cables can be easily damaged if they are improperly handled or installed. Handle the optical cables with care to avoid damage.

#### 3.4.3. HDMI Input and Output Ports

The extender provides standard 19-pole HDMI connector with screw lock.

**ATTENTION!** Always use high-quality HDMI cable for connecting sources and displays.



#### 3.4.4. Ethernet (LAN) Port

HDMI20-OPTC series extenders are supplied Neutrik etherCON connector (NE8FBH-S type) for Ethernet/ LAN connection. The Ethernet port can be connected to an indoor LAN hub, switch or router by a CATx cable. However, both cable types (straight or cross) are supported and handled by the device, below pin assignment is recommended.

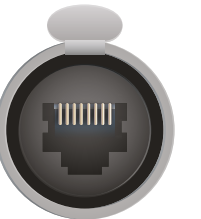

Pin	TIA/EIA T568 A	Color and name	TIA/EIA T568 B	Color and name
1		white/green stripe		white/orange stripe
2		green solid		orange solid
3		white/orange stripe		white/green stripe
4		blue solid		blue solid
5		white/blue stripe		white/blue stripe
6		orange solid		green solid
7		white/brown stripe		white/brown stripe
8		brown solid		brown solid



### 3.4.5. USB Connector

HDMI20-OPTC series have standard USB mini-B receptacle.

### 3.4.6. RS-232 Port

The extenders have RS-232 pass-through function or can be remote controlled through industry standard 9-pole D-SUB male connector.

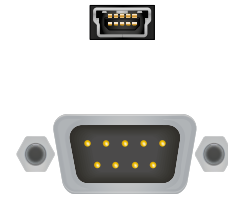

D-sub connector pin assignment for standard RS-232	
Pin nr.	Pinout
1	NC - non-connected
2	RX data receive (input)
3	TX data transmit (output)
4	DTR (Internally connected to Pin 6)
5	GND signal ground (shield)
6	DSR (Internally connected to Pin 4)
7	RTS (Internally connected to Pin 8)
8	CTS (Internally connected to Pin 7)
9	NC - non-connected

INFO: HDMI20-OPTC series extenders are DTE unit according to its pin-out. For more information see [Serial Management](#) section.

INFO: Factory default settings are the same in the transmitter and receiver: 57600 Baud, 8 bit, 1stop bit, no parity.

## 3.5. Multimode Single Fiber Extender Concept

HDMI20-OPTC series devices are a HDMI 2.0-compatible single fiber extender pair. They are able to transmit digital video, embedded audio, RS-232 and Gigabit Ethernet signals via multimode optical cable up to 700m. They are designed for rental purposes, supporting uncompressed 4K UHD resolution at 60Hz at 4:4:4 colorspace.

The extenders use only the one channel of the optical cable, and the other channel is internally connected to break-out connector. See details about in [Application Example with Break-out Connector](#) section.

### 3.5.1. Summary of Interfaces - Transmitter

**Inputs:**

- HDMI →
- Ethernet 2x →
- RS-232 →
- OPTC (break-out) →

**+ Control Interfaces:**

- USB



**Outputs:**

- OPTC
  - HDMI
  - Ethernet
  - RS-232
- HDMI

### 3.5.2. Summary of Interfaces - Receiver

**Inputs:**

- HDMI →
  - Ethernet →
  - RS-232 →
- OPTC →

**+ Control interfaces:**

- USB



**Outputs:**

- HDMI
- Ethernet 2x
- RS-232
- OPTC (break-out)

### 3.6. Optical Interface

HDMI20-OPTC extenders support multimode fiber optical interface to transmit or receive digital video, embedded audio, RS-232 and Ethernet signals. For more details about the supported cable extension distances see [Maximum Extension Distances](#) section.

#### Port Diagram of Optical Interface

The Neutrik opticalCON DUO cable has two fiber channels, named **channel A** and **channel B**. Since Lightware fiber extenders use only one fiber for signal transmission, the other fiber can be used by other optical devices. The unused fiber channel is accessible by the break-out connector.

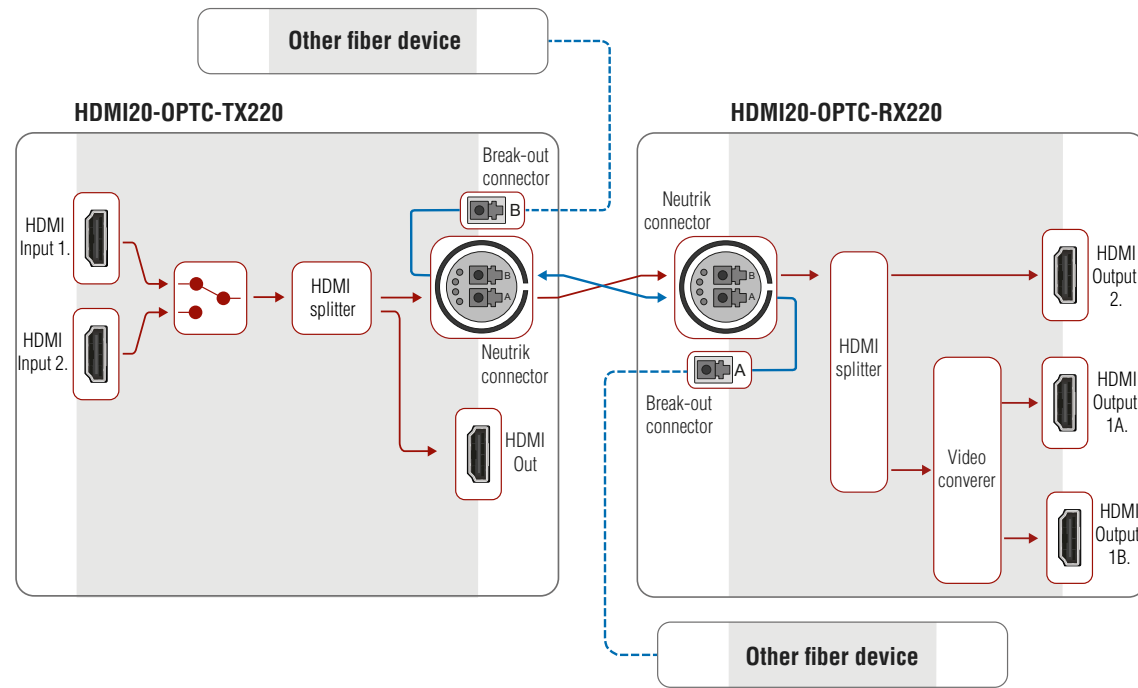

INFO: Red line shows the main direction of the video signal. The blue line represents the optical signal via break-out connector, which direction is not specified.

#### Application Example with Break-out Connector

Using this feature, it is possible to transmit two different A/V signal from one transmitter pair to another receiver pair with only one Neutrik opticalCON DUO cable. See the application example below.

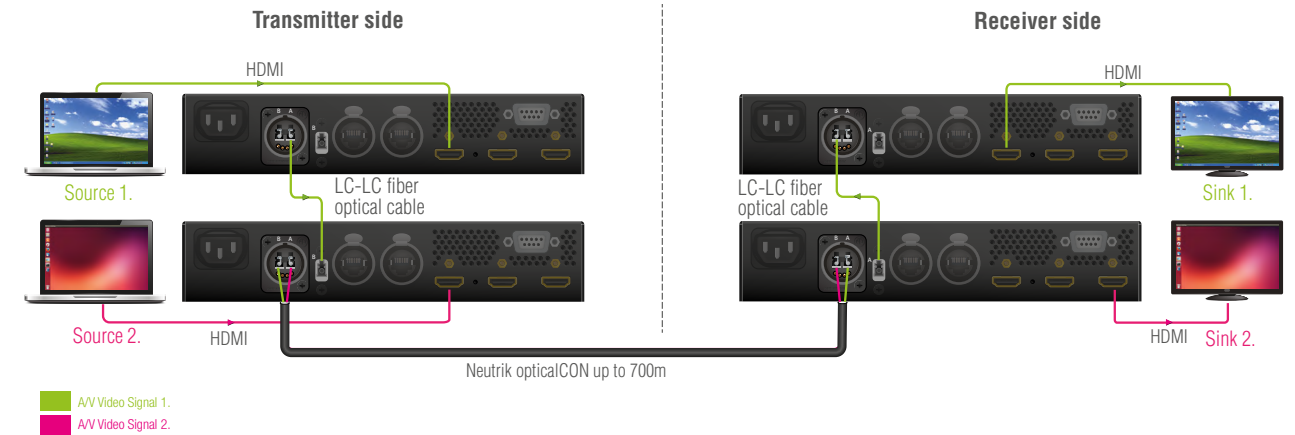

#### Transmitter Unit (HDMI20-OPTC-TX220)

The transmitter's laser driver sends the signal through **Channel A**. **Channel B** is directly connected to the break-out connector with a fiber optical cable inside the unit. Any optical signal can be transferred through this channel in any direction.

#### Receiver Unit (HDMI20-OPTC-RX220)

The receiver's laser sensor gets the signal through **Channel B**. **Channel A** is directly connected to the break-out connector with a fiber optical cable inside the unit. Any optical signal can be transferred through this channel in any direction.

INFO: Break-out connector can be used in the same way in all variants.

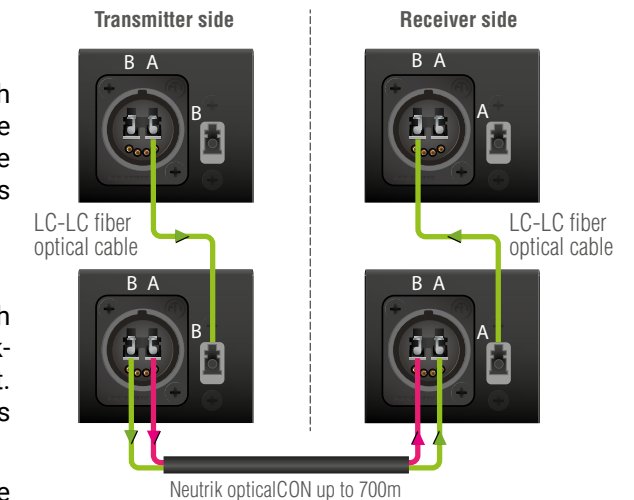

### 3.7. Video and Audio Interface

The HDMI20-OPTC series transmitter can receive signal from two types of sources:

- DVI-D
- HDMI (with embedded audio)

The HDMI20-OPTC series receiver can output HDMI video signal (with embedded audio).

#### Port Diagram of Video and Audio Interface

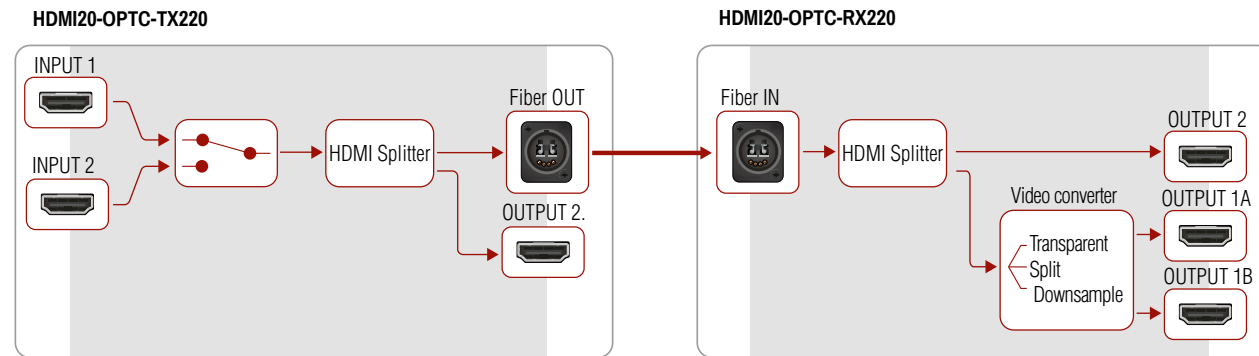

#### Transmitter Side

The video signal is received at the Input 1 or the Input 2. The HDMI splitter duplicates the signal and sends the same HDMI stream to the local HDMI output and the fiber output.

#### Receiver Side

The video and the embedded audio signal arrives via optical cable into the HDMI splitter. It duplicates HDMI stream and transmits the signal without modifying it to the HDMI Out 2 port. The HDMI splitter transmits the same signal into the video converter where three output conversion modes can be set.

#### 3.7.1. Output Conversion Modes

Conversion modes refer to the receiver side and this property can be set in the front panel menu of the transmitter (see [Conversion Submenu](#)), available in the Lightware Device Controller Software (see [HDMI Output Port - Receiver](#)) and also in the LW3 tree, both the transmitter and the receiver.

In **Transparent mode** (no conversion mode), the video signal is transmitted to the HDMI Output 1A and the HDMI Output 1B without any changing.

**INFO:** Maximal data transmission capacity of Output 1B is 9 Gbps, if the video signal is above this bandwidth, there will be no picture on the display.

**Split mode** means splitting of the original video signal into left and right halves and sending the split signal to the HDMI Output 1A and the HDMI Output 1B.

In **Downsample convert mode** (convert to YCbCr 4:2:0) the video converter subsamples the 4:4:4 signal to 4:2:0 on the 1A and 1B Output port.

**INFO:** Split and downsample convert modes are available at maximum 8-bit color depth.

#### 3.7.2. Autoselect Feature

Besides manual crosspoint selection you can choose the Autoselect option on the video ports. There are three types of Autoselect as follows:

- **First detect mode:** selected input port is kept connected to the output while it has an active signal
- **Priority detect mode:** always the highest priority active input is selected to transmit.
- **Last detect mode:** always the last attached input is selected to transmit.

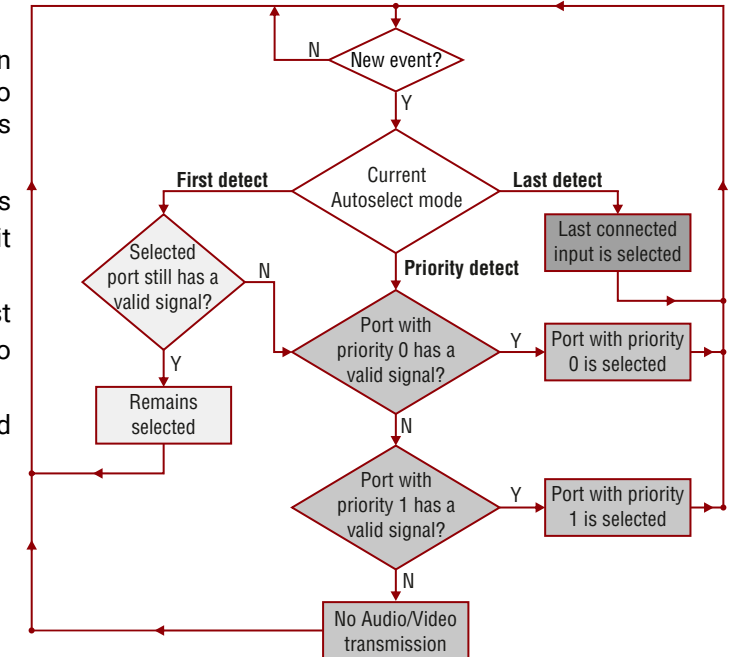

#### Video Interface - Example

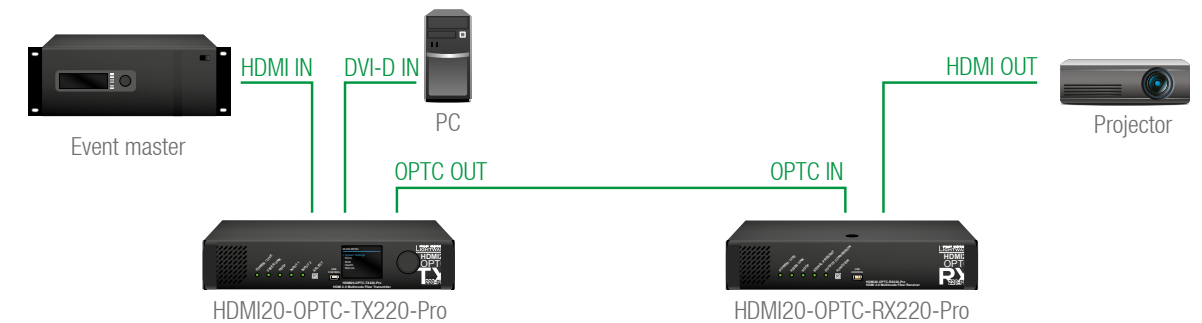

#### The Concept

The HDMI signal with embedded audio comes from the Event master to Input 1. The other source is a PC, which sends DVI-D signal to Input 2. Both of them are connected to the transmitter, where the autoselect mode is enabled with priority 0 on the Input 1, so the Input 1 is selected.

**INFO:** Only one input can be selected at the same time.

### 3.8. Control Features

The devices can be controlled over Ethernet, USB, and RS-232 ports as well. The following sections are about to describe the available features and settings by these interfaces.

#### 3.8.1. USB Control Interface

The device can be controlled over front panel USB port (mini B-type connector). This interface supports LW3 protocol. The interface can be used to establish a connection to Lightware Device Controller software.

**INFO:** USB control operates locally, USB data is not transmitted via optical cable between the transmitter and the receiver.

#### 3.8.2. Ethernet Interface

The device can be controlled via Ethernet port (Neutrik etherCON connector). This interface supports any third-party system controller with LW3 command protocol. The interface can be used to configure the device with Lightware Device Controller and establish the connection to Lightware Device Updater software and perform firmware upgrade.

Two Neutrik etherCON connectors provide a wide range of application possibilities:

- Control the device
- Firmware upgrade
- Create a local network
- Daisy chain connection

#### Port Diagram of Ethernet Interface

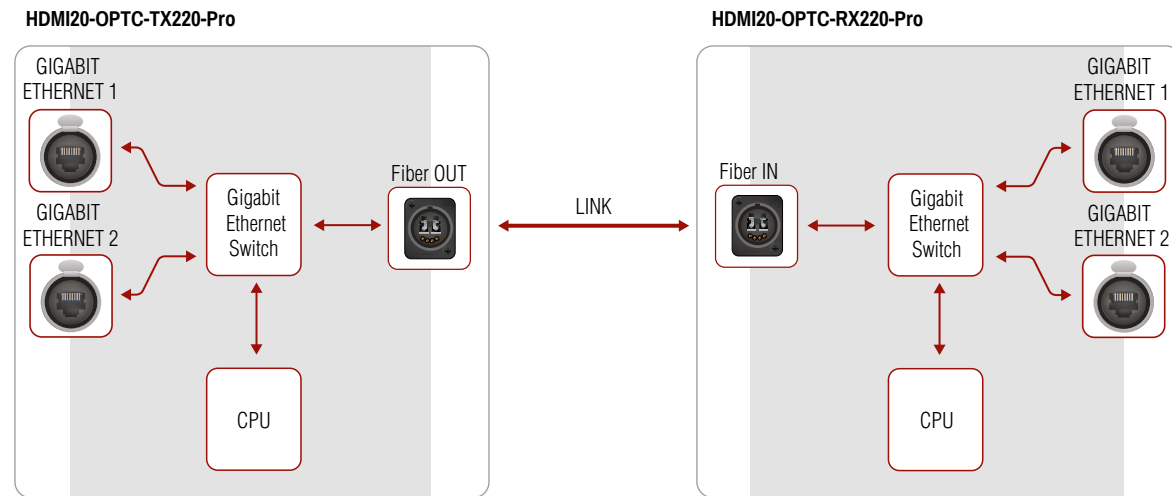

#### Ethernet Interface - Example



**Transmitters** are connected to each other via LAN, the **receivers** connected to the **transmitters** via optical fiber and all the **projectors** connected to the **receivers** via LAN.

This way the **Laptop** can control the system with Ethernet commands:

- HDMI20-OPTC.TX220-PRO (1-3.).
- HDMI20-OPTC.RX220-PRO (1-3.).
- Projector (1-6.).

### 3.8.3. Serial Interface

INFO: HDMI20-OPTC series extenders are DTE unit according to their pin-out. For more details about pin assignment see [RS-232 Port](#) section.

Serial data communication can be established via local RS-232 port (D-SUB male connector). Three different RS-232 modes can be set for the serial port: pass-through mode, control mode, command injection mode, see the figure below.

#### Port Diagram of Serial Interface

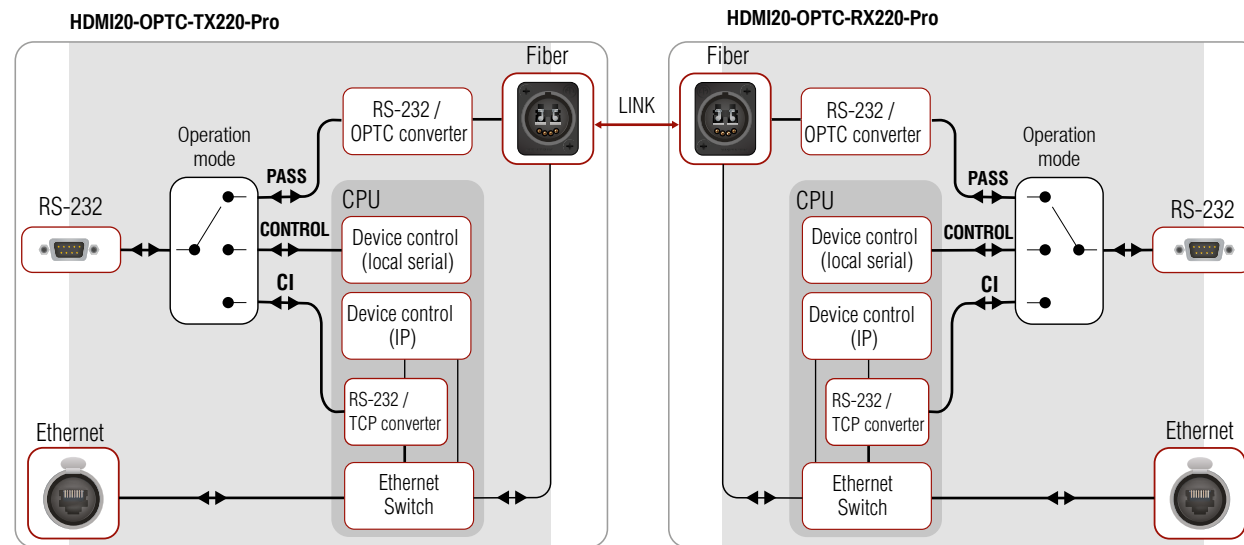

The following operation modes are defined:

- **PASS:** The local serial port is in **Pass-through mode**.
- **CONTROL:** The local serial port is in **Control mode**.
- **CI:** The local serial port is in **Command Injection mode**.

#### Pass-through Mode

In pass-through mode, the given device forwards the data that is coming from one of its ports to another same type of port. The command is not processed by the CPU. Incoming serial data is forwarded from one port to another port.

**ATTENTION!** Both the transmitter and the extender have to be set **Pass-through mode**, in case of sending RS-232 commands from the TX side to the third party device on the RX side.

#### Control Mode

The incoming data from the given local port is processed and interpreted by the CPU. The mode allows to control the extender directly. LW3 protocol commands are accepted.

#### Command Injection Mode

In this mode, the extender works as a TCP/IP <-> RS-232 bidirectional converter. The TCP/IP data signal is converted to RS-232 data and vice versa. TCP/IP port numbers are defined for the serial ports for this purpose. E.g. the default Command Injection port number of the local RS-232 port is 8001.

INFO: The commands in this mode not transmitted via fiber, they operates between the local ports.

#### RS-232 Signal Transmission - Example 1

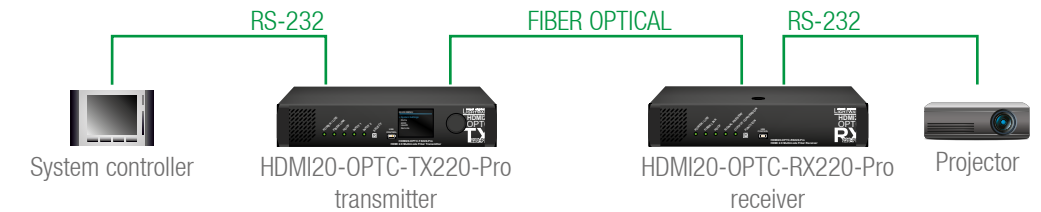

#### The Concept

You can control the **Projector** over the extenders with the **System controller**. The controller is connected to the local RS-232 port of the **Transmitter** which transmits the signal toward the **Receiver** over the fiber optical line. The **Projector** is connected to the local RS-232 port of the **Receiver**. The serial connection is bidirectional which means the controller gets back the responses of the projector.

In this case the RS-232 port of the transmitter and receiver has to be set to **Pass-through mode**.

# 4

## Operation

This chapter is about the powering and operating of the device describing the functions which are available by the front/rear controls:

- ▶ [POWERING ON](#)
- ▶ [FRONT PANEL OPERATIONS](#)
- ▶ [FRONT PANEL LCD MENU OPERATIONS](#)

### 4.1. Powering on

Connect the power cord to the AC input connector; the extender is immediately powered on. After the self-test, the last configuration is loaded automatically.

### 4.2. Front Panel Operations

**ATTENTION!** When Dark mode is enabled, no LEDs are on, even though the device is fully functional.

#### Status LEDs - Transmitter

POWER/LIVE			FRONT
	green	blinking	The transmitter unit is powered and ready to use.
	green	on	The transmitter unit is out of operation.
		off	The transmitter unit is NOT powered or out of operation.
FIBER LINK			FRONT
	green	on	The connection is established between the transmitter and the receiver and they can communicate to each other.
		off	When the TX and RX are not connected.
	yellow	blinking	It shows connection error in the RX and TX.
HDCP			FRONT
	green	on	Video signal is HDCP-encrypted.
		off	There is no HDCP encryption in the video signal.
	yellow	blinking	It shows HDCP error.
INPUT1, INPUT2			FRONT
	green	on	This port is selected and there is a valid video signal on it.
	green	blinking	When the port is selected and there is no valid video signal on it.
	yellow	on	When the port is not selected, but there is a valid video signal on it.
		off	This port is not selected and there is no signal on it.
LASER ACTIVE			REAR
	red	on	It gives feedback about the operation of the optical module, that means the laser radiates invisible waves. Avoid direct eye contact with the optical connectors!
		off	Laser module is not active.

#### Status LEDs - Receiver

POWER/LIVE			FRONT
	green	blinking	The receiver unit is powered and ready to use.
		off	The receiver unit is NOT powered or out of operation.
FIBER LINK			FRONT
	green	on	The connection is established between the transmitter and the receiver and they can communicate to each other.
		off	When the TX and RX are not connected.
	yellow	blinking	It shows connection error in the RX and TX.
HDCP			FRONT
	green	on	Video signal is HDCP-encrypted.
		off	There is no HDCP encryption in the video signal.
	yellow	blinking	It shows HDCP error.
SIGNAL PRESENT			FRONT
	green	on	Valid video signal is present.
		off	No video signal is present.
	yellow	blinking	It shows error in the video signal transmission.
OUTPUT CONVERSION			FRONT
	green	on	Split mode is active.
		off	Transparent mode (no conversion) is active.
	yellow	on	Downsample convert (convert to YCbCr 4:2:0) mode is active.
LASER ACTIVE			REAR
	red	on	It gives feedback about the operation of the optical module, that means the laser radiates invisible waves. Avoid direct eye contact with the optical connectors!
		off	Laser module is not active.

**INFO:** When LEDs blink green three times after clicking on the Input/Function button, they show that the front panel lock is enabled.

#### 4.2.1. Function Button - Transmitter

 Select button is for switching between the Input 1 and the Input 2. Autoselect mode can not be activated by pushing the **Select** button, but this function can be disabled by choosing Input 1 or Input 2 with the **Select** button.

INFO: Autoselect mode can be set with Lightware Device Controller software (see [HDMI Output Port - Transmitter](#) and [Optical Output Port - Transmitter](#) section) or with protocol commands (see [Changing the Autoselect Mode](#) section).

##### Enable Dynamic (DHCP) IP Address

The device gets a static IP address as a factory default setting. If this setting does not fit to the circumstances during install or usage, DHCP\* can be enabled from the front panel:

- Step 1.** Make sure the device is powered on and operational.
- Step 2.** Press and keep pressed the **Select** button for 5 seconds.
- Step 3.** After 5 seconds front panel LEDs start blinking; release the button and press it 3 times again quickly (within 1,5 seconds).
- Step 4.** The LEDs get dark, DHCP gets enabled.
- Step 5.** As a final step, device restarts and is available with the new IP address.

\* Static IP address also can be modified. This setting is available on the front panel menu or in Lightware Device Controller software.

##### Restore Factory Default Settings

To restore factory default values, do the following steps:

- Step 1.** Make sure the device is powered on and operational.
- Step 2.** Press and keep pressed the **Select** button for 10 seconds. After 5 seconds front panel LEDs start blinking but keep on pressing the button.
- Step 3.** After 5 seconds the blinking gets faster; release the button and press it 3 times again quickly (within 1,5 seconds).
- Step 4.** The LEDs get dark, the device restores the factory default settings and reboots.

Factory default settings are listed in the [Factory Default Settings](#) section.

#### 4.2.2. Function Button - Receiver

 Function button sets the output conversion mode. See details about these modes in [Output Conversion Modes](#) section.

##### Enable Dynamic (DHCP) IP Address

The device gets a static IP address as a factory default setting. If this setting does not fit to the circumstances during install or usage, DHCP\* can be enabled from the front panel:

- Step 1.** Make sure the device is powered on and operational.
- Step 2.** Press and keep pressed the **Function** button for 5 seconds.
- Step 3.** After 5 seconds front panel LEDs start blinking; release the button and press it 3 times again quickly (within 1,5 seconds).
- Step 4.** The LEDs get dark, DHCP gets enabled.
- Step 5.** As a final step, device restarts and is available with the new IP address.

\* Static IP address also can be modified. This setting is available on the front panel menu or in Lightware Device Controller software.

##### Restore Factory Default Settings

To restore factory default values, do the following steps:

- Step 1.** Make sure the device is powered on and operational.
- Step 2.** Press and keep pressed the **Function** button for 10 seconds. After 5 seconds front panel LEDs start blinking but keep on pressing the button.
- Step 3.** After 5 seconds the blinking gets faster; release the button and press it 3 times again quickly (within 1,5 seconds).
- Step 4.** The LEDs get dark, the device restores the factory default settings and reboots.

Factory default settings are listed in the [Factory Default Settings](#) section.

#### 4.2.3. Boot Button

Hidden button for special bootload function. Use only for the particular request of the Lightware Support Team.

### 4.3. Front Panel LCD Menu Operations

The front panel has a color LCD that shows the most important settings and parameters structured in a menu. The jog dial control knob can be used to navigate between the menu items or change the value of a parameter. The knob can be pressed to enter a menu or edit/set a parameter.

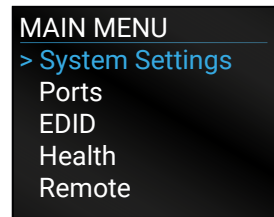

Menu navigation & change parameter

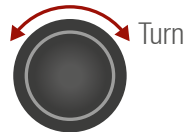

Menu selection & set parameter

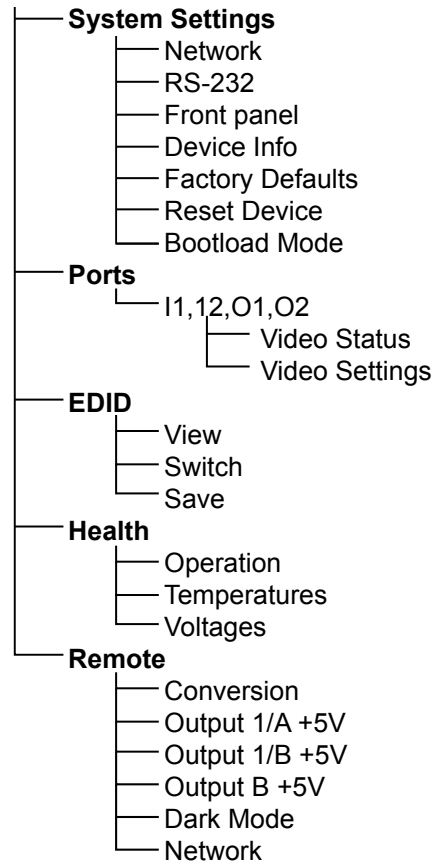

#### Parameter Selection

The **blue** colored line means the selected menu/parameter, the **green** one means the current setting.

**TIPS AND TRICKS:** The faster you rotate the jog dial, the faster the parameter list is scrolled.

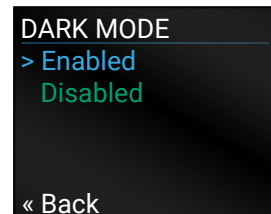

#### 4.3.1. System Settings Menu

##### Network Submenu

The parameters of the network connection can be set in this submenu. IP, Subnet, Gateway and MAC parameters show the current settings. If the DHCP option is disabled, three more parameters are listed which can be set for a static IP address:

- Static IP,
- Static Subnet,
- Static Gateway.

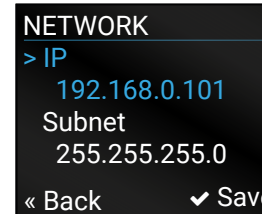

**ATTENTION!** If you change the network settings, always press the Save option under Network menu (not only in the submenu of the parameter) to apply the new settings.

##### RS-232 Submenu

Adjustable parameters of the local RS-232 port:

- Mode (Pass-through/ Control/ Command injection),
- Baud Rate (4800/ 7200/ 9600/ 14400/ 19200/ 38400/ 57600/ 115200)
- Protocol (LW2/ LW3).

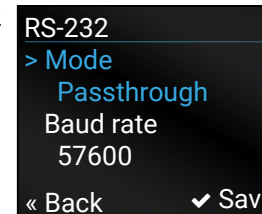

##### Front Panel Submenu

The following front panel-related parameters can be set in this submenu:

- Display Backlight (1-10)
- Dark Mode (Enabled/ Disabled)

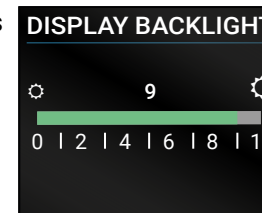

The brightness of the LCD can be set from 1 to 10 on a scale.

All the LEDs and the background light of the LCD on the transmitter unit are turned off 60 s after enabling the dark mode.

**TIPS AND TRICKS:** Press any buttons or turn the jog dial knob to **wake up** the device. The first contact activates the LEDs and LCD and does not execute the original function.

**INFO:** The dark mode setting of the receiver is available in the [Remote Menu](#).

- Rotary Direction (CW Down/ CCW Down)

##### Device Info Submenu

In this submenu you can check basic information about the transmitter unit:

- Serial number
- Hardware Version
- Firmware Version
- Video MCU #1
- Video MCU #2

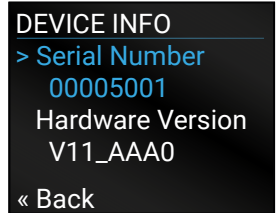

##### Factory Defaults Submenu

Factory default settings will be restored by choosing **Yes**.

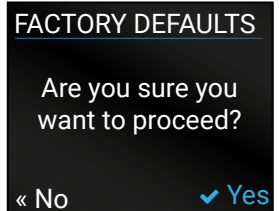

##### Reset Device Submenu

There is a possibility to reset the device.

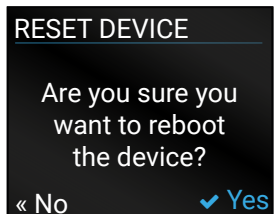

##### Bootload Mode Submenu

Special function for entering the bootload mode.

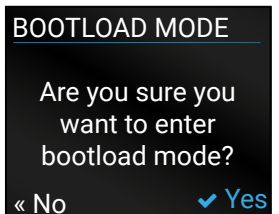



### 4.3.2. Ports Menu

When entering the menu the available video input and output ports are listed. The icons display information about the port and the video signal (see below table). Select the desired port and enter to see the submenu.

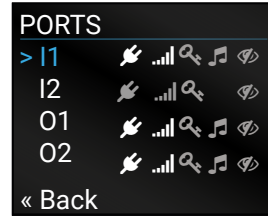

Grey icon	Description	White icon	Description
	Source/sink is <b>not</b> connected		Source/sink is connected
	No audio signal in the video stream		Audio is embedded in the video stream
	Signal is <b>not</b> present		Signal is present
	Signal is <b>not</b> encrypted with HDCP		Signal is encrypted with HDCP
	The port is unmuted		The port is muted

### Video Status Submenu for Input Ports

The most important status information can be seen of the chosen input port.

The table below relates to the input ports of both the transmitter and receiver.

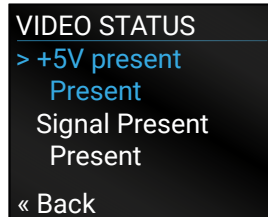

Parameter	I1	I2
+5V present	Present/ Not present	Present/ Not present
Signal Present	Present/ Not present/ Unknown	Present/ Not present/ Unknown
HDCP Status	none/ HDCP 1.4/HDCP 2.2	none/ HDCP 1.4
Embedded Audio	Present/ Not present/ Unknown	Present/ Not present/ Unknown
Pixel Clock (MHz)	No signal/ [x] MHz	No signal/ [x] MHz
Active Resolution	Unknown/ No signal/ [x]x[y][i\p][f]	-
Total Resolution	Unknown/ No signal/ [x]x[y]	-

### Video Settings Submenu for Input Ports

- I1: HDCP Enable (Disabled / HDCP 1.4 only / HDCP 2.2 or 1.4)
- I2: HDCP Enable (Disabled / HDCP 1.4 only)

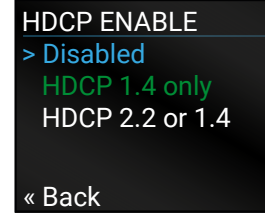

### Video Status Submenu for Output Ports

The most important status information can be seen of the chosen output port.

The table below relates to the output ports of both the transmitter and receiver.

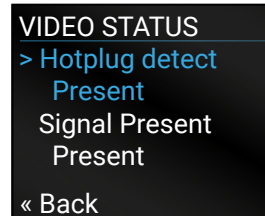

Parameter	O1 (OPTOUT)	O2 (HDMIOUT)
Hotplug detect	Present/ Not present	Present/ Not present
Signal Present	Present/ Not present/ Unknown	Present/ Not present/ Unknown
HDCP Status	none/ HDCP 1.4/HDCP 2.2	none/ HDCP 1.4/ HDCP 2.2
HDCP capability	-	none/ HDCP 1.4/ HDCP 2.2
Embedded Audio	Present/ Not present/ Unknown	Present/ Not present/ Unknown
Pixel Clock (MHz)	No signal [x] MHz	No signal [x] MHz
Active Resolution	Unknown/ No signal [x]x[y][i\p][f]	Unknown/ No signal [x]x[y][i\p][f]
Total Resolution	Unknown/ No signal/ [x]x[y]	Unknown/ No signal/ [x]x[y]

### Video Settings Submenu for Output Ports

- Signal Type (Auto / DVI)
- +5V Enable (Always on / Always off / Auto)
- HDCP Mode (Auto / Always on)

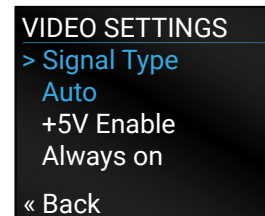

### 4.3.3. EDID Menu

Advanced EDID Management is available in the front panel LCD menu which allows to view an EDID, switch, or save it to the User EDID memory. See more information about EDID technology in [EDID Management](#). The EDID memory structure of the device can be found in [Sources and Destinations](#) chapter.

#### View Submenu

Select the desired EDID memory block: **Factory EDIDs**, **Last Attached EDIDs**, **User EDIDs**, or **Emulated EDIDs**. Select the **Name** item and press the knob. Use the jog dial to step between the EDIDs. The following information can be checked:

- Preferred Resolution
- Monitor Name
- Audio Info

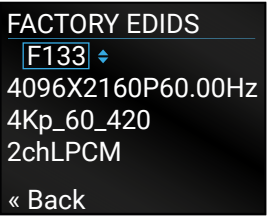

#### Switch Submenu

The submenu looks similar to the View submenu but in this case, the Destination is also listed. To change an EDID do the followings:

- Step 1. Navigate to the **EDID/Switch** submenu.
- Step 2. Select the **Name** item and press the knob. Use the jog dial to select the desired **EDID** (F1-F146, U1-U14, or D1-D2) and press the knob.
- Step 3. Select the **Destination** item and press the knob. Use the jog dial to select the desired **EDID memory** (E1, E2, All) and press the knob.
- Step 4. Navigate to the **Switch** option and press the knob.

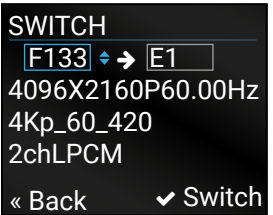

#### Save Submenu

The EDID of a connected sink can be saved to the User EDID memory as follows:

- Step 1. Navigate to the EDID/Save submenu.
- Step 2. Select the **Name** item and press the knob. Use the jog dial to select the desired **EDID** (D1-D2\*) and press the knob.
- Step 3. Select the **Destination** item and press the knob. Use the jog dial to select the desired **EDID memory** (U1-U14) and press the knob.
- Step 4. Navigate to the **Save** option and press the knob.

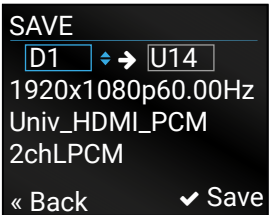

\* D1 is for Optical output and D2 is for local HDMI output.

#### 4.3.4. Health Menu

##### Operation Submenu

The following information is displayed about the transmitter unit in this menu:

- Uptime: the elapsed time since the last booting.
- Operation time: displays the summary of the operation hours.

```
OPERATION
> Uptime
  0 days 02:33:23
Operation Time
  5 days 06:12:44
« Back
```

##### Temperatures Submenu

This submenu gives a feedback about the current temperatures of the internal parts in the unit:

- CPU / System / Air intake / Video chip / Ethernet switch / Video MCU #1 / Video MCU #2.

##### Voltages Submenu

The following information is displayed in Voltages Submenu:

- Main 5V / Main 3.3V, Video IC #11.3V V/1 / Video IC #11.3V V/2 / Video IC #2 1.3V/1 / Video IC #2 1.3V/2

#### 4.3.5. Remote Menu

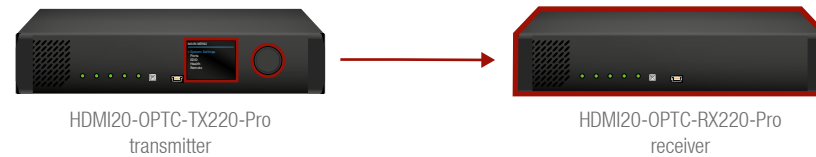

**ATTENTION!** This settings related to the connected **receiver**.

Adjustable parameters of the receiver:

##### Conversion Submenu

The following conversion modes can be set in the receiver:

- Off
- YUV 4:2:0
- Split left/right
- Split right/left

See more details about this mode in [Output Conversion Modes](#) section.

##### Output 1/A +5V, Output 1/B +5V, Output 2 +5V Submenu

- Always on
- Always off
- Auto

##### Dark Mode (Enabled/Disabled) Submenu

All the LEDs on the receiver unit are turned off 60 seconds after enabling the dark mode. Waking up the device is available by disabling the dark mode.

##### Network Submenu

The parameters of the **receiver's** network connection can be set in this submenu. IP, Subnet, Gateway and MAC parameters show the current settings. If the DHCP option is disabled, three more parameters are listed which can be set for a static IP address:

- Static IP,
- Static Subnet,
- Static Gateway.

```
NETWORK
> IP
  192.168.0.102
Subnet
  255.255.255.0
« Back      ✓ Save
```

**ATTENTION!** If you change the network settings, always press the Save option under Network menu (not only in the submenu of the parameter) to apply the new settings.

# 5

## Software Control – Using Lightware Device Controller

The extender can be controlled by a computer through the LAN, RS-232 and USB ports using Lightware Device Controller (LDC). The software can be installed on a Windows PC or macOS X. The application can be downloaded from [www.lightware.com](http://www.lightware.com). The Windows and the Mac versions have the same look and functionality.

- ▶ [INSTALL AND UPGRADE](#)
- ▶ [RUNNING THE LDC](#)
- ▶ [ESTABLISHING THE CONNECTION](#)
- ▶ [CROSSPOINT MENU - HDMI20-OPTC-TX220-PRO](#)
- ▶ [PORT PROPERTIES WINDOW](#)
- ▶ [EDID MENU](#)
- ▶ [CONTROL MENU](#)
- ▶ [EVENT MANAGER](#)
- ▶ [SETTINGS MENU](#)
- ▶ [ADVANCED VIEW WINDOW](#)

### 5.1. Install and Upgrade

**INFO:** After the installation, the Windows and the Mac application has the same look and functionality.

#### Installation for Windows OS

Run the installer. If the User Account Control drops a pop-up message click **Yes**.

During the installation you will be prompted to select the type of the installation: **normal** and the **snapshot** install:

Normal install	Snapshot install
Available for Windows and macOS X	Available for Windows
The installer can update only this instance	Cannot be updated
Only one updateable instance can exist for all users	More than one different version can be installed for all users

*Comparison of installation types*

**ATTENTION!** Using the Normal install as the default choice is highly recommended.

#### Installation for macOS X

Mount the DMG file with double clicking on it and drag the LDC icon over the Applications icon to copy the program into the Applications folder. If you want to copy the LDC into another location just drag the icon over the desired folder.

**INFO:** The MAC installer is equal with the Normal install in case of Windows and results an updateable version with the same attributes.

#### Upgrading of LDC

**Step 1.** Run the application.

The **Device Discovery** window appears automatically and the program checks the available updates on Lightware's website and opens the update window if the LDC found updates.

The current and the update version number can be seen at the top of the window and they are shown in this window even with the snapshot install.

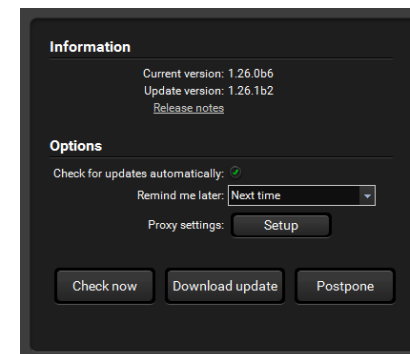

The **Update** window can also be opened by clicking the **About icon** (?) and the **Update** button.

**Step 2.** Set the desired update setting in the **Options** section.

- When the **Check for updates automatically** option is marked, the LDC tries to find a new version after startup.
- If you want to postpone the update, set the reminder by the **drop down list**.
- If necessary, the proxy settings are available by clicking the **Setup** button.

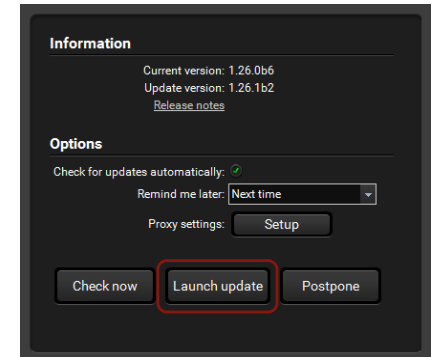

**Step 3.** Click the **Download update** button to start the upgrading.

**Step 4.** When the download process finished, the **Download Update** button changes to **Launch update**. Click it on to install the new version.

### 5.2. Running the LDC

The common way to start the software is double-click on the LDC icon. But the LDC can be run by command line parameters as follows:

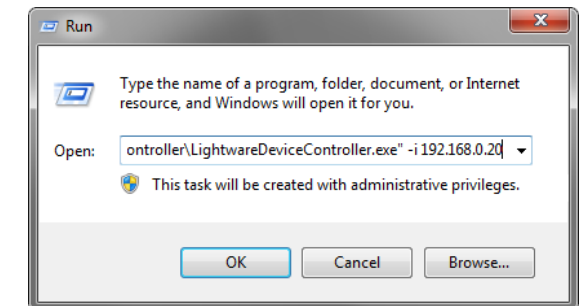

#### Connecting to a Device with Static IP Address

**Format:** LightwareDeviceController -i <IP\_address>:<port>

**Example:** LightwareDeviceController -i 192.168.0.20:6107

The LDC is connected to a device with the indicated static IP address directly; the Device Discovery window is not displayed. When the port number is not set, the default port is used: 6107 (LW3 protocol)

### 5.3. Establishing the Connection

**Step 1.** Connect the device to a computer via USB, RS-232 or Ethernet.

**Step 2.** Run the controller software; device discovery window appears automatically.

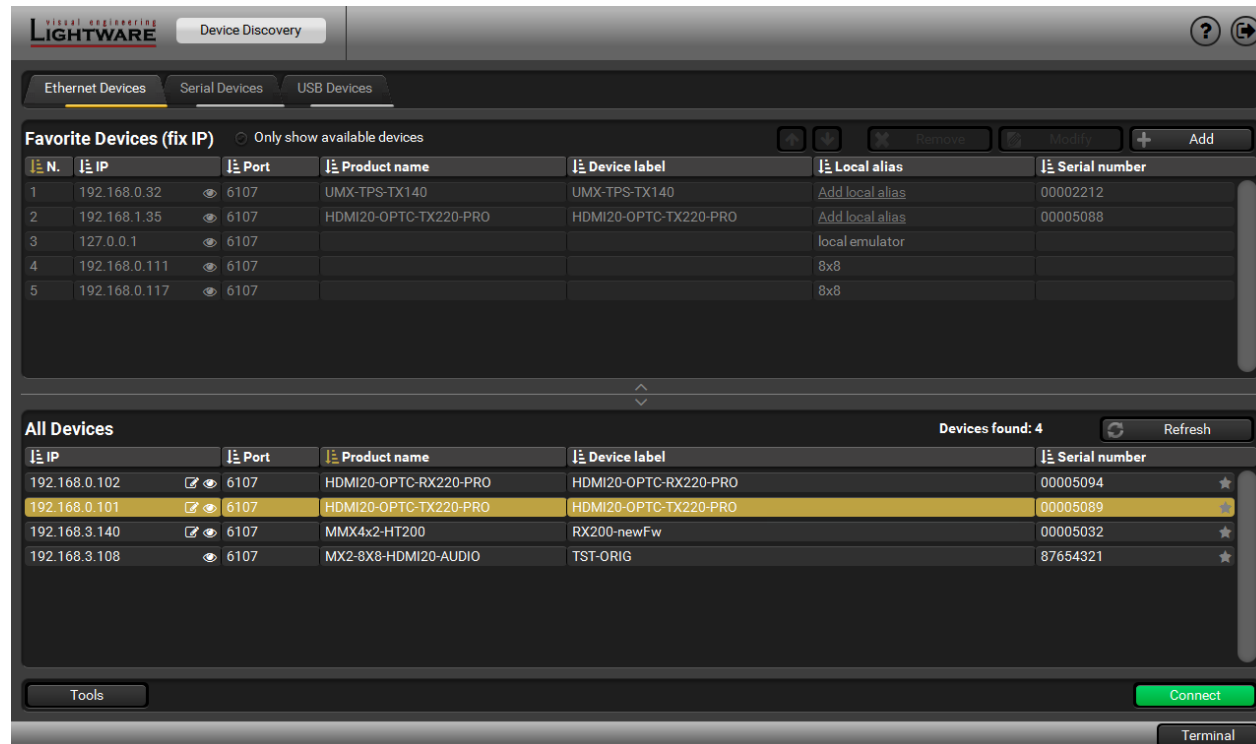

**Device Discovery Window in LDC**

**Step 3.** Select the unit from the discovered Ethernet devices or under USB devices; when the device is connected through RS-232 click on the **Query** button next to the desired serial port to display the device's name and serial number. Double click on the receiver or select the device and click on the **Connect** button.

**ATTENTION!** When the device is connected via the local RS-232 port, make sure that Control mode and LW3 protocol are set on the serial port.

#### Change IP Address



To modify IP address settings quickly it is not necessary to enter the device's settings/network menu, you can set them by clicking the pencil icon beside the IP address. In this window you can see only the new settings.

This will change the IP address settings of the selected device remotely.

DHCP  Fix IP

Serial number: 00004148

IP Address: 192.168.0.100

Network mask:

Default gateway:

#### Identifying the Device



Clicking on the  icon results in the blinking of the LDC screen for 10 seconds. The feature helps to identify the device itself in the rack shelf.

#### Further Tools

The **Tools** menu contains the following options:

- **Log Viewer:** The tool can be used for reviewing log files which have been saved previously.
- **Create EDID:** This tool opens the Easy EDID Creator wizard which can be used for creating unique EDIDs in a few simple steps. Functionality is the same as the Easy EDID Creator, for the detailed information see [Creating an EDID](#) section.
- **Demo Mode:** This is a virtual MX-FR17 matrix router with full functionality built into the LDC. Functions and options are the same as a real MX-FR17 device.

The **Terminal** window is also available by pressing its button on the bottom.

### 5.4. Crosspoint Menu - HDMI20-OPTC-TX220-PRO

#### Video Tab

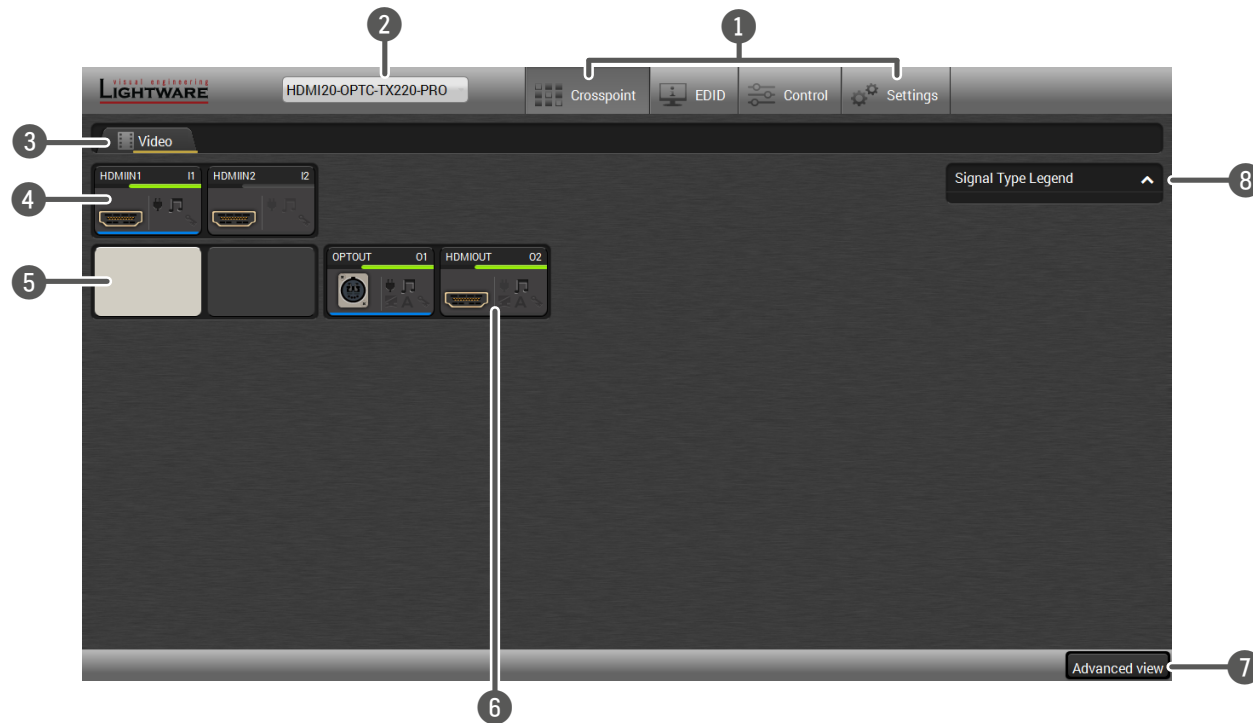

Video Tab in Crosspoint Menu

- 1 **Main menu** The available menu items are displayed. The active one is shown with dark grey background color.
- 2 **Information ribbon** It shows the device label which can be edited in the Settings menu - [Status Tab](#). A drop-down menu is displayed by clicking on this ribbon. You can turn back to the Device Discovery Window or open the connected TX or RX in a new window (if it is in the same LAN).
- 3 **Tab selector ribbon** Submenu selection by clicking on the tab.
- 4 **Input ports** Click on the port to open the Port properties window.
- 5 **Connections** Light grey square means the port is available but there is no connection between the input and the output. White square means there is a connection between the input and the output port.
- 6 **Output ports** Click on the port to open the Port properties window.
- 7 **Advanced view** Click on the button to display the Advanced view page. It shows the Terminal window and the LW3 protocol tree.
- 8 **Legend panel** The applied colors of the input/ output ports are described in this panel.

#### Port Tiles

The colors of the port tiles and the displayed icons represent different states and information:

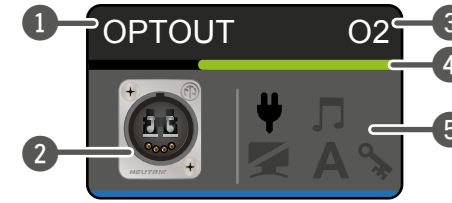

- 1 Port name
- 2 Port icon
- 3 Port number
- 4 Signal present indicator  
**green:** present / **grey:** not present
- 5 State indicators

#### State Indicators

Icon	Icon is grey	Icon is black
	Source/sink is <b>not</b> connected	Source/sink is connected (+5V / Hotplug detected)
	Audio is <b>not</b> embedded in the video stream	Audio is embedded in the video stream
	Port is unmuted	Port is muted
	HDCP encryption is <b>not</b> enabled	HDCP encryption is enabled
Icon	Icon is grey	Icon is green
	Autoselect setting is disabled	Autoselect setting is enabled

## 5.5. Port Properties Window

### 5.5.1. HDMI Input Port - Transmitter

By clicking on one of the HDMI input tile, the most important video related information and settings are available in the port properties window.

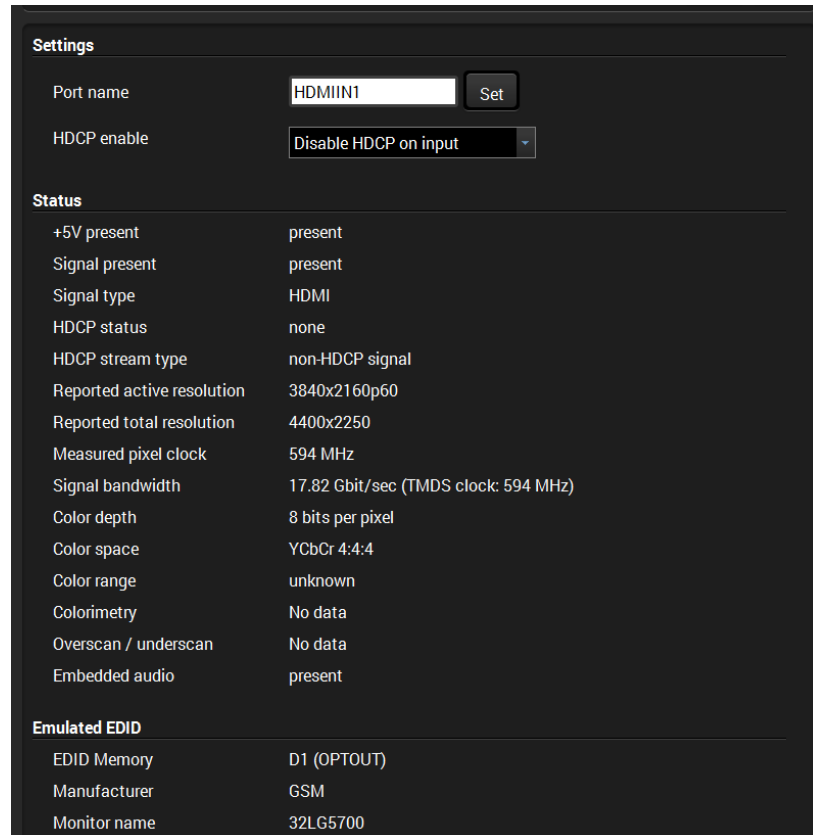

#### Available Settings:

- Port name
- HDCP Enable (Disable HDCP input / Allow HDCP 1.4 only / Allow HDCP 2.2 and HDCP 1.4).

Port number	max. HDCP version
I1	HDCP 2.2
I2	HDCP 1.4

- Reloading factory defaults (see more details in [Factory Default Settings](#) section).

**INFO:** Factory default settings have not effect on the emulated EDID.

### 5.5.2. HDMI Output Port - Transmitter

Click on the local HDMI output port to open the port properties window. The most important information and settings are available from the panel.

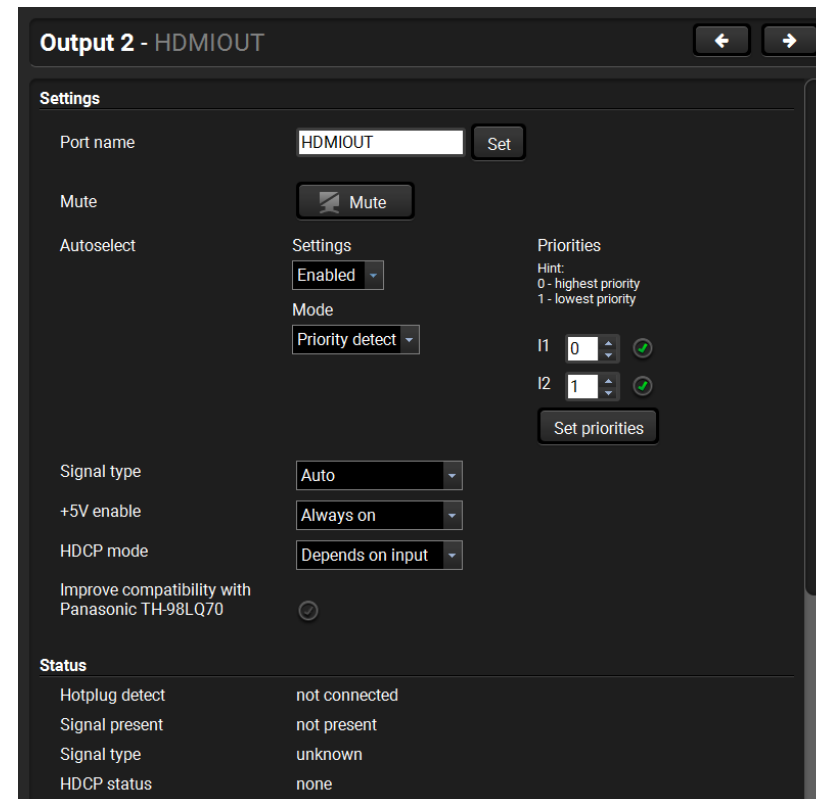

#### Available settings:

- Change the name of the port;
- Mute/unmute the port;
- Autoselect settings: enable / disable, mode, and priorities. (See more details in [Autoselect Feature](#) section)
- Auto/DVI/HDMI signal type;
- Enabling the +5V: Auto / Always on / Always off;
- HDCP mode: Depends on input / Maximum possible
- Enable compatibility support of Panasonic TH-98LQ70

**Depends on input:** The encryption level depends on the settings of the input port and the source content/device. If the incoming signal is not encrypted, then the outgoing signal will not be encrypted either.

**Maximum possible:** The highest supported level of encryption.

- Factory default settings for the selected port.

### Optical Output Port - Transmitter

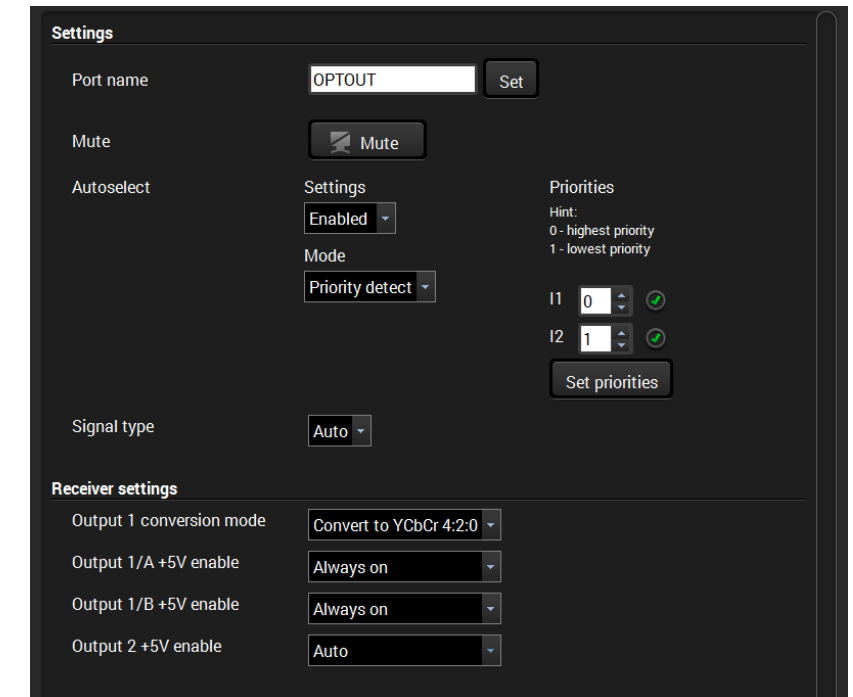

#### Available settings (related to the transmitter):

- Change the name of the port;
- Mute/unmute the port;
- Autoselect settings: enable / disable, mode, and priorities. This setting is always the same on both outputs. (See more details in [Autoselect Feature](#) section)
- Auto/DVI/HDMI signal type;
- Factory default settings for the selected port.

#### Available settings (related to the receiver):

- Output 1 conversion mode: No conversion / Convert to YCbCr 4:2:0 / Split A: left, B: right / Split A: right, B: left. For more information see [Output Conversion Modes](#) section.
- Output 1/A +5V enable: Auto / Always on / Always off
- Output 1/B +5V enable: Auto / Always on / Always off
- Output 2 +5V enable: Auto / Always on / Always off

### 5.5.3. Optical Input Port - Receiver

**Input 1 - OPTIN**

Settings

Port name:

Status

Remote device present	present
Signal present	present
Signal type	HDMI
HDCP status	none
HDCP stream type	non-HDCP signal
Reported active resolution	3840x2160p60
Reported total resolution	4400x2250
Measured pixel clock	594 MHz
Signal bandwidth	17.82 Gbit/sec (TMDS clock: 594 MHz)
Color depth	8 bits per pixel
Color space	YCbCr 4:4:4
Color range	unknown
Colorimetry	No data
Overscan / underscan	No data
Embedded audio	present

Emulated EDID

EDID Memory	D1 (HDMIOUT1A)
Manufacturer	GSM
Monitor name	32LG5700
Preferred resolution	1920x1080p59.93Hz

Other

Factory defaults

#### Available Settings:

- Port name;
- Reloading factory defaults (see factory default settings in the [Factory Default Settings](#) section).

INFO: Factory default settings have not effect on the emulated EDID.

### 5.5.4. HDMI Output Port - Receiver

**Output 1 - HDMIOUT1A**

Settings

Port name:

Mute:

Signal type:

+5V enable:

HDCP mode:

Conversion mode:

Improve compatibility with Panasonic TH-98LQ70:

Status

Hotplug detect	not connected
Signal present	not present
Signal type	unknown
HDCP status	none
HDCP stream type	non-HDCP signal
HDCP capability	none
Reported active resolution	No signal
Reported total resolution	No signal
Measured pixel clock	0 MHz
Signal bandwidth	N/A
Color depth	unknown
Color space	unknown
Color range	unknown
Colorimetry	No data
Overscan / underscan	No data
Embedded audio	unknown

Other

Factory defaults

#### Available Settings:

- Change the name of the port;
- Mute/unmute the port;
- Auto/DVI/HDMI signal type;
- Enabling the +5V: Auto / Always on / Always off
- HDCP mode: Depends on input / Maximum possible

**Depends on input:** The encryption level depends on the settings of the input port and the source content/device. If the incoming signal is not encrypted, then the outgoing signal will not be encrypted either.

**Maximum possible:** The highest supported level of encryption.

- Output 1 conversion mode: No conversion / Convert to YCbCr 4:2:0 / Split A: left, B: right / Split A: right, B: left. For more information see [Output Conversion Modes](#) section.

INFO: Conversion mode setting effects only on HDMIOUT1A (O1) and HDMIOUT1B (O2) port, so HDMIOUT2 (O3) port does not have not this setting.

- Enable compatibility support of Panasonic TH-98LQ70
- Factory default settings for the selected port.

## 5.6. EDID Menu

Advanced EDID Management can be accessed by selecting the EDID menu. There are two panels: left one contains **Source EDIDs**, right one contains **Destination** slots where the EDIDs can be emulated or copied.

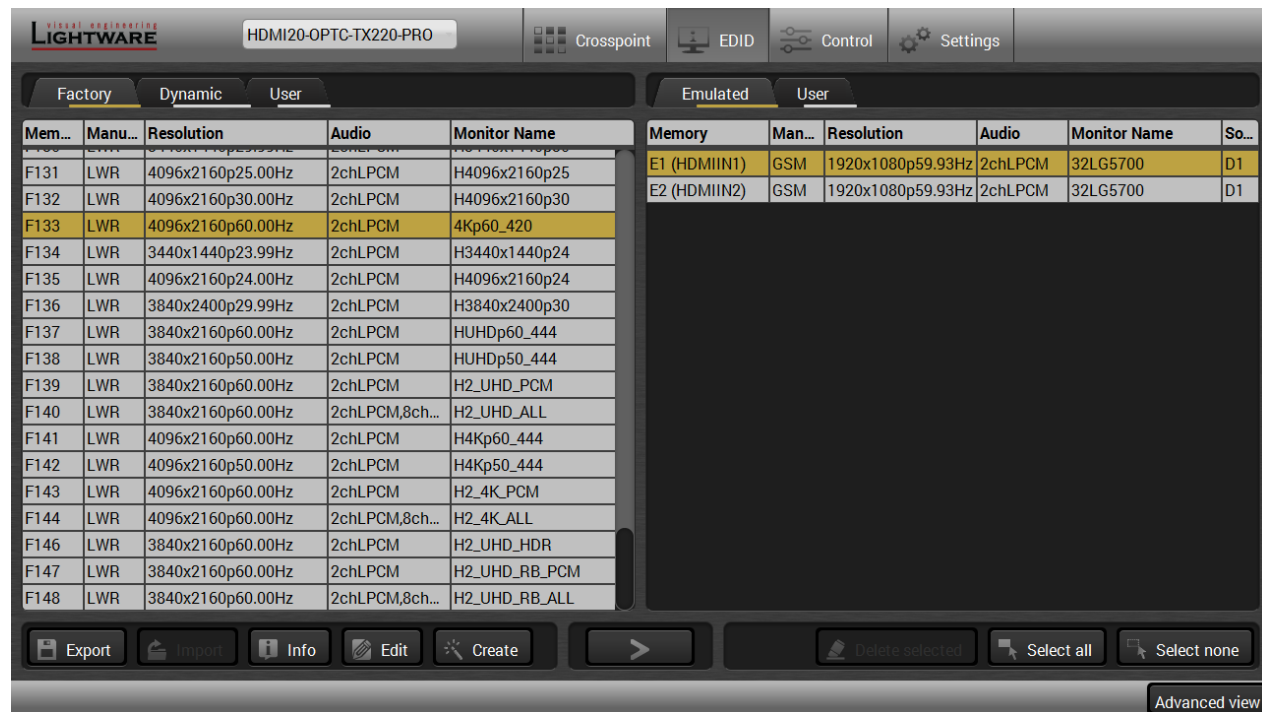

### Control buttons

	Exporting an EDID (save to a file)		Executing EDID emulation or copying (Transfer button)
	Importing an EDID (load from a file)		Deleting EDID (from User memory)
	Display EDID Summary window		Selecting all memory places in the right panel
	Opening Advanced EDID Editor with the selected EDID		Selecting none of the memory places in the right panel
	Opening Easy EDID Creator		

### 5.6.1. Sources and Destinations

The EDID memory consists of four parts:

- **Factory EDID list (F1-F146)** the pre-programmed EDIDs, see the [Factory EDID List](#) in the Appendix section.
- **Dynamic EDID list (D1-D2)**: the EDID of the last attached display device. The extender stores the last EDID from the previously connected sink on each output port. Thus, an EDID can be shown even if there is no device is connected to the output port at that moment.
- **User memory locations (U1 – U14)**: they can be used to save custom EDIDs. Any EDID from the User/Factory/Dynamic EDID lists can be copied to the user memory.
- **Emulated EDID list (E1-E2)**: the currently emulated EDID for the input. The source column displays the memory location that the current EDID was routed from. The source reads the EDID from the Emulated EDID memory on the input port.

There are two types of emulation: **static** and **dynamic**.

- **Static EDID emulation**: an EDID from the Factory or User EDID list is selected. Thus, the Emulated EDID remains the same until the user emulates another EDID.
- **Dynamic EDID emulation**: it can be enabled by selecting D1-D2 EDID memory. The attached monitor's EDID is copied to the input; if a new monitor is attached to the output, the emulated EDID is changed automatically.

**INFO:** The default emulated EDID is D1 both the transmitter and the receiver. The EDID, which is from the attached monitor of HDMIOUT1A (O1) port of the receiver, is copied to all the input ports.

### 5.6.2. EDID Operations

#### Changing the Emulated EDID

- Step 1.** Choose the desired tab (**Factory**, **Dynamic**, or **User** EDID list) on the left panel and select an **EDID**.
- Step 2.** Select the **Emulated** tab on the right panel.
- Step 3.** Select the **target port** on the right panel (one or more ports can be selected); the EDID(s) will be highlighted with a yellow cursor.
- Step 4.** Press the **Transfer** button to change the emulated EDID.

#### Learning an EDID

The process is the same as changing the emulated EDID; the only difference is the **Destination** panel: press the **User** button. Thus, one or more EDIDs can be copied into the user memory either from the factory memory or from a connected sink (Dynamic).

#### Exporting an EDID

Source EDID can be downloaded as a file (\*.bin, \*.dat or \*.edid) to the computer.

- Step 1.** Select the desired **EDID** from the **left panel** (the line will be highlighted with yellow).
- Step 2.** Press the **Export** button to open the dialog box and **save** the file to the computer.





### Importing an EDID

Previously saved EDID (\*.bin, \*.dat or \*.edid file) can be uploaded to the **user memory**:

**Step 1.** Select the **User** tab in the left panel and select a memory slot.

**Step 2.** Press the **Import** button below the Source panel.

**Step 3.** Browse the file in the opening window then press the **Open** button. Browsed EDID is imported into the selected User memory.



**ATTENTION!** The imported EDID overwrites the selected memory place even if it is not empty.

### Deleting EDID(s)

The EDID(s) from User memory can be deleted as follows:

**Step 1.** Select the **User** tab in the left panel.

**Step 2.** Select the desired memory slot(s); one or more can be selected (**Select all** and **Select None** buttons can be used). The EDID(s) will be highlighted with yellow.

**Step 3.** Press the **Deleted selected** button to delete the EDID(s).



### 5.6.3. EDID Summary Window

Select an EDID from Source panel and press the **Info** button to display EDID summary.

General	General
General	EDID version: 1
Power Management	EDID revision: 3
Gamma / Colors	Manufacturer ID: GSM (Goldstar Company Ltd)
Established Timings	Product ID: 085B
Standard Timings	Monitor serial number: 356928
Preferred Timing Mode	Year of manufacture: 2017
2nd Descriptor Field	Week of manufacture: 3
3rd Descriptor Field	Signal interface: Digital
4th Descriptor Field	Separate Sync H&V: -
CEA General	Composite sync on H: -
CEA Video	Sync on green: -
CEA Audio	Serration on VS: -
CEA Speaker Allocation	Color depth: Undefined
CEA HDMI VSDB	Interface standard: Not defined
CEA HDMI Forum VSDB	Color spaces: RGB 4:4:4 & YCrCb 4:4:4
CEA YCbCr 4:2:0 VDB	Aspect ratio: 0.57
CEA YCbCr 4:2:0 Capability Map	Display size: 60 cm X 34 cm
CEA Colorimetry	
CEA High Dynamic Range	
CEA Detailed Timing Descriptors	

### 5.6.4. Editing an EDID

Select an EDID from the left panel and press the **Edit** button to display Advanced EDID Editor window. The editor can read and write all descriptors, which are defined in the standards, including the additional CEA extension. Any EDID from the device's memory or a saved EDID file can be loaded into the editor. The software resolves the raw EDID and displays it as readable information to the user. All descriptors can be edited, and saved in an EDID file, or uploaded to the User memory.

Basic EDID	EDID Byte Editor
Vendor / Product Information	0 00 FF FF FF FF FF 00 1E 6D
Display Parameters	10 08 5B 40 72 05 00 03 1B 01 03
Power Management and Features	20 80 3C 22 78 EA 30 35 A7 55 4E
Gamma / Color and Established Timings	30 A3 26 0F 50 54 21 08 00 71 40
Standard Timings	40 81 80 81 C0 A9 C0 D1 C0 81 00
Preferred Timing Mode	50 01 01 01 01 04 74 00 30 F2 70
2nd Descriptor Field	60 5A 80 B0 58 8A 00 58 54 21 00
3rd Descriptor Field	70 00 1E 56 5E 00 A0 A0 A0 29 50
4th Descriptor Field	80 30 20 35 00 58 54 21 00 00 1A
CEA Extension	90 00 00 00 FD 00 38 3D 1E 87 1E
General	100 00 0A 20 20 20 20 20 20 00 00
Video Data	110 00 FC 00 4C 47 20 55 6C 74 72
Audio Data	120 61 20 48 44 0A 20 01 D2
Speaker Allocation Data	
HDMI VSDB	
HDMI Forum VSDB	
YCbCr 4:2:0 VDB	
YCbCr 4:2:0 Capability Map	
Colorimetry	
High Dynamic Range	
Detailed Timing Descriptor #1	
Detailed Timing Descriptor #2	
Detailed Timing Descriptor #3	
Detailed Timing Descriptor #4	
Detailed Timing Descriptor #5	
Detailed Timing Descriptor #6	
Save EDID	

EDID Editor Window

### 5.6.5. Creating an EDID

Since above mentioned Advanced EDID Editor needs more complex knowledge about EDID, Lightware introduced a wizard-like interface for fast and easy EDID creation. With Easy EDID Creator it is possible to create custom EDIDs in four simple steps. By clicking on the **Create** button below the left panel, Easy EDID Creator is opened in a new window.

**Select Resolution & Interface**

Welcome to the Easy EDID Creator!

With this software you are able to create a unique EDID according to your demands. Details can be added or changed in the Advanced EDID Editor later if needed.

Please select the format type and the preferred resolution. If you don't find the proper mode in the list, use the Custom format type setting, enter the resolution and the program will estimate the best blanking times.

Important notes:

- If you want to send audio then you must select HDMI or DisplayPort. DVI and VGA do not support audio transmission.
- Most DVI displays are not able to process HDMI signals. If you have a DVI display, please check its specifications.
- The supported color depth will be 24bits/pixel by default.

Format type:

Resolution:

Interface type:

*Easy EDID Creator Wizard*

## 5.7. Control Menu

### 5.7.1. RS-232 Tab

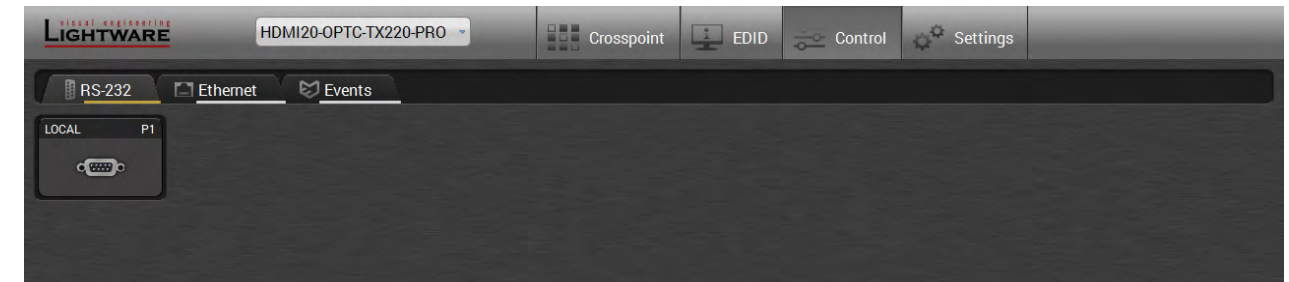

*RS-232 tab in Control menu*

The following settings and functions are available on the local RS-232 port:

- Port name
- Operation mode: Pass-through, Control, Command Injection, (for more details see [Serial Interface](#) section);
- Baud rate: 4800, 7200, 9600, 14400, 19200, 38400, 57600, 115200;
- Data bits: 8 or 9;
- Parity: None, Odd, or Even;
- Stop bits: 1, 1.5, or 2;
- Command injection: enable or disable;
- Command injection port number;
- Control protocol: LW2 or LW3;
- Message sending via serial port;
- Reloading factory defaults (see the [Factory Default Settings](#) section).

**Port 1 - LOCAL**

**Settings**

Port name:

Operation mode:

Baud rate:

Data bits:

Parity:

Stop bits:

Configuration: 57600, 8N1

**Command injection**

Enable command injection:

Port:

Status: Disabled

**Control protocol**

Required protocol:

Actual protocol: LW2

**Send message**

Send message:

**Other**

Factory defaults:

### 5.7.2. Ethernet Tab

Four ports are displayed in the Ethernet tab: Ethernet (P1, P2), OPT1, and CPU. The Ethernet ports (P1 and P2) display the status of the Ethernet, speed, and the duplexity of the connection. The following settings are also available:

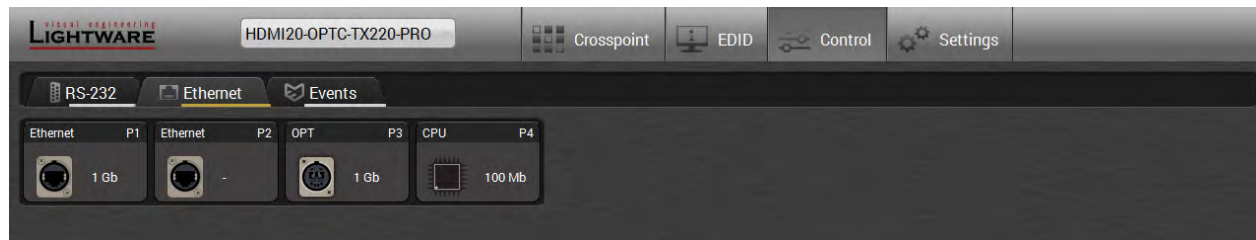

- Enable / disable the port (for loop protection);
- Reloading factory defaults (see factory default settings in the [Factory Default Settings](#) section).

**ATTENTION!** If the Ethernet port is set to disabled, this may break the connection with the device.

**INFO:** OPT1 and CPU Ethernet port can not be disabled.

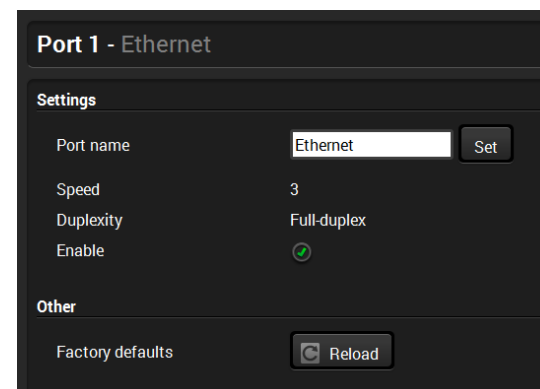

### 5.8. Event Manager

The feature means that the device can sense changes on its ports and able to react according to the pre-defined settings. The development idea of the Event manager is based on users' feedbacks. In many cases internal events (such as signal present) are necessary to display but it is not easy when the device is hard to access (e.g. built under the desk).



**INFO:** For tips and tricks and detailed description about the application of Event Manager, please download the Event Manager User's Guide from the Download section on the [www.lightware.com](http://www.lightware.com).

The Event manager can be configured to perform an action if a condition has been detected. E.g. the desired setup is that after a certain type of signal has been detected on I1 port, the port has to be switched to O1. The settings can be done via the LDC in the Control/Events tab, or by LW3 protocol commands. Configurable events number depends on the device what you are using actually.

Numerous new ideas and requests have been received in connection with the features and settings of the Event manager since the first release. Therefore, the user interface has been re-designed and many new functions implemented. The Event editor can be opened by pressing the Edit button at each Event.

There is a **grey bar** on the left of the Event panel in each line. If a condition and an action are set and the Event is enabled, the bar is displayed in **green**.

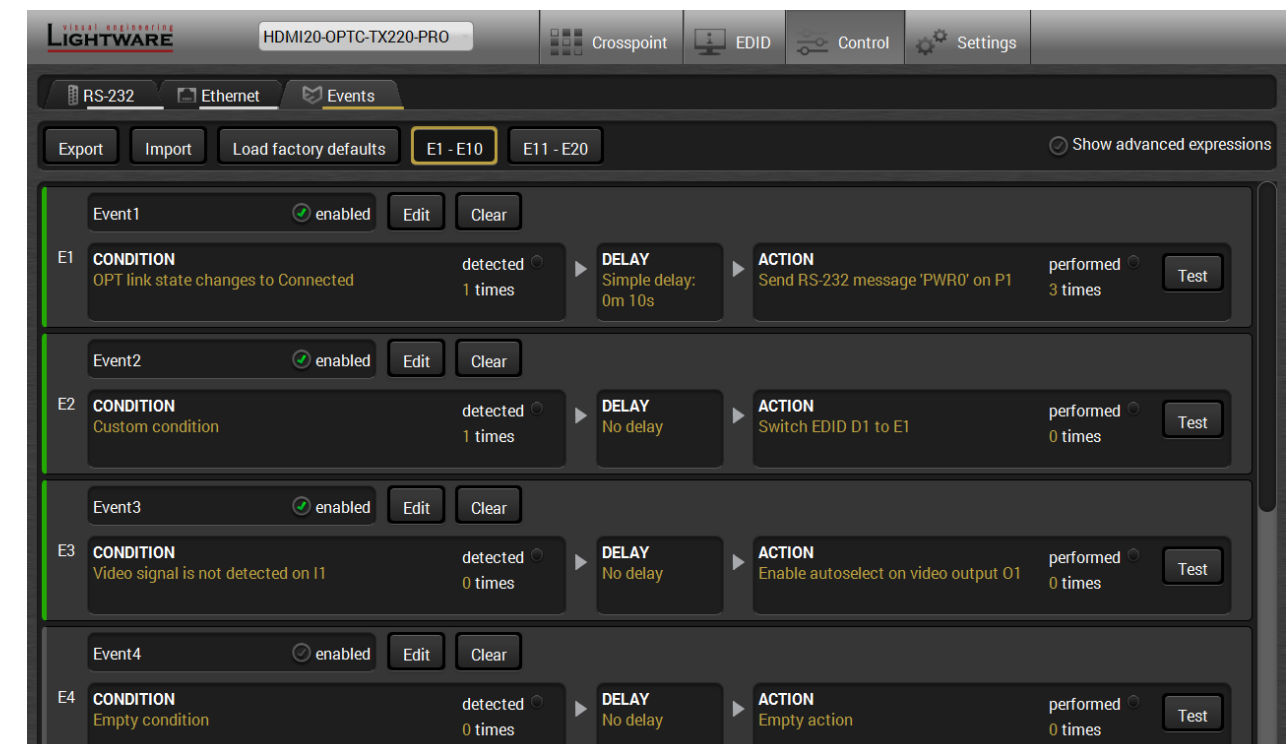

Control menu, Event Manager tab

### 5.8.1. The Event Editor

Press the **Edit** button in the desired Event line to open the Event editor window.

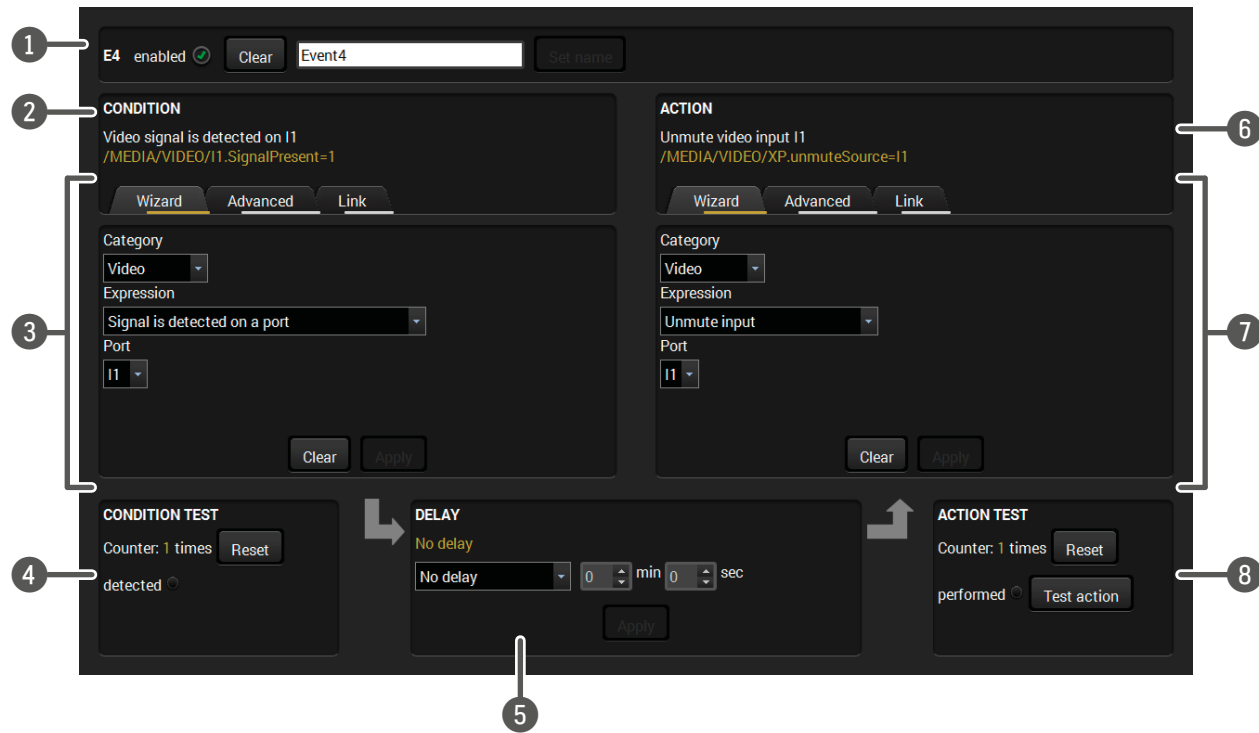

- 1 **Event header** The name of the Event is displayed. Type the desired name and press the Set name button. The Event can be cleared by the Clear button. Use the tick mark to enable/disable the Event.
- 2 **Condition header** If the condition is set, the description (white colored text) and the exact LW3 protocol expression (yellow colored text) can be seen. If the advanced mode was used the description is "Custom condition".
- 3 **Condition panel** The Wizard, the Advanced or the Link tool is available to set the condition. The parameters and settings are displayed below the buttons.
- 4 **Condition test** The set condition can be tested to see the working method in the practice.
- 5 **Delay settings** The action can be scheduled to follow the condition after the set time value.
- 6 **Action header** If the action is set, the description (white colored text) and the exact LW3 protocol expression (yellow colored text) can be seen. If the advanced mode was used the description is "Custom action".
- 7 **Action panel** The Wizard, the Advanced or the Link tool is available to set the action. The parameters and settings are displayed below the buttons.
- 8 **Action test** The set action can be tested to see the working method in the practice.

### 5.8.2. Create or Modify an Event

#### Wizard Mode

The wizard mode lists the most common conditions and actions, so the user does not have to look for LW3 nodes and properties.

**Step 1.** Click on the **Edit** button of the desired Event; the **Event editor** is displayed.

**Step 2.** The wizard mode is displayed as default. Select the desired **Category** first (e.g. Audio or Video).

**Step 3.** Select the desired **Expression** from the drop-down menu. If any other parameter is necessary to set, it is going to be displayed.

**Step 4.** Press the **Apply** button to store the settings of the Condition.

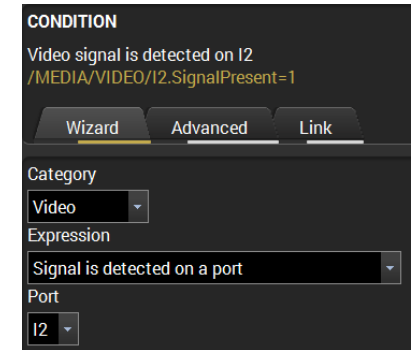

Conditions and actions in wizard mode in the transmitter			
<b>Condition</b>			
Category	Expression	Ports	
General	Select button is pressed		
	OPT link state changes to Connected		
	OPT link state changes to Disconnected		
Video	Signal is detected on a port	I1, I2, O1, O2	
	Signal is not detected on a port	I1, I2, O1, O2	
	Signal type changes to DVI	I1, I2, O1, O2	
	Signal type changes to HDMI	I1, I2, O1, O2	
	Signal type changes to Undefined (no signal)	I1, I2, O1, O2	
<b>Action</b>			
Category	Expression	Input	Output
Video	Switch input to output	I1, I2	O1, O2
	Enable autoselect on output		O1, O2
	Disable autoselect on output		O1, O2
	Mute input	I1, I2	
	Mute output		O1, O2
	Unmute input	I1, I2	
	Unmute output		O1, O2
		Port	Message
RS-232	Send RS-232 message	P1	
		Source EDID	Destination EDID
EDID	Switch EDID	F1-146	E1, E2
		D1-2	
		U1-14	

Conditions and actions in wizard mode in the receiver			
Condition			
Category	Expression	Ports	
General	Function button is pressed		
	OPT link state changes to Connected		
	OPT link state changes to Disconnected		
Video	Signal is detected on a port	I1, 01, 02, 03	
	Signal is not detected on a port	I1, 01, 02, 03	
	Signal type changes to DVI	I1, 01, 02, 03	
	Signal type changes to HDMI	I1, 01, 02, 03	
	Signal type changes to Undefined (no signal)	I1, 01, 02, 03	
Action			
Category	Expression	Input	Output
Video	Switch input to output	I1	01, 02, 03
	Enable autoselect on output		01, 02, 03
	Disable autoselect on output		01, 02, 03
	Mute input	I1	
	Mute output		01, 02, 03
	Unmute input	I1	
	Unmute output		01, 02, 03
		Port	Message
RS-232	Send RS-232 message	P1	
		Source EDID	Destination EDID
EDID	Switch EDID	F1-146	E1
		D1-2	
		U1-14	

### Advanced Mode

The goal of this mode is the same as of the wizard: set the properties and methods for conditions and actions. The difference is the number of the available and usable properties and methods of the LW3 protocol. Advanced mode allows almost all of it.

**Step 1.** Click on the **Edit** button of the desired Event; the **Event editor** is displayed.

**Step 2.** The wizard mode is the default, press the **Advanced** button. The LW3 protocol tree is displayed showing the list of the properties in the drop-down menu. Navigate to the desired node.

**Step 3.** Select the desired **Property** from the menu. The **manual** of the property is displayed below to help to select the necessary property and to set the value.

**Step 4.** Set the desired **value** and **operator**, then press the **Apply** button to store settings.

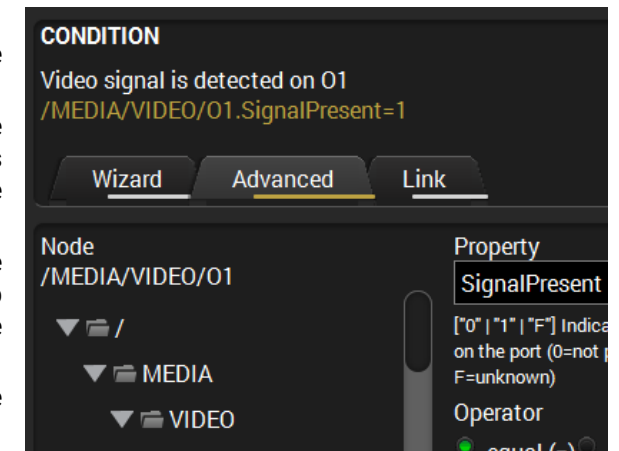

### The Link Tool

The interface allows creating more actions to the same condition. In that case, a condition can trigger more actions. To set such an Event, the Link tool has been introduced.

**Step 1.** Click on the **Edit** button of the desired Event; the **Event editor** is displayed.

**Step 2.** The wizard mode is displayed as default, press the **Link** button.

**Step 3.** All the saved Events are analyzed and the **conditions** are listed (it takes some seconds to finish). The **Show advanced expressions** option allows showing the exact path and set the value of the given property.

**Step 4.** Select the desired **Condition** and press the **Apply** button to store the settings.

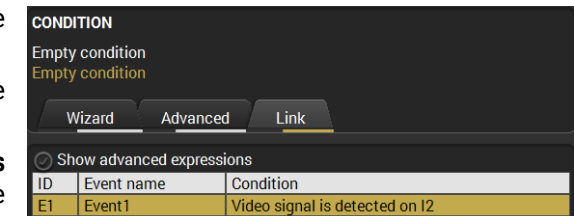

### 5.8.3. Special Tools and Accessories

#### The Name of the Event

The name of a port can be changed by typing the new name and clicking the **Set name** button. The following characters are allowed when naming:

Letters (A-Z) and (a-z), numbers (0-9), special characters: hyphen (-), underscore (\_), and space ( ).

#### Enable or Disable an Event

The set Event can be enabled or disabled in the Event list, or directly in the Event editor window by setting the **tick mark** beside the name.

#### Testing the Condition

When the desired Condition is arranged, the setting can be tested. The Event list and the Event editor contains a small panel that shows if the set condition is detected and how many times. The **Counter** can be reset by the button in Event editor. If the Condition is true, the **detected** mark turns green for two seconds and the **Counter** is increased.

#### Testing the Action

The method is the same as testing the Condition, but in this case, the Action can be triggered manually by pressing the **Test** button.

**TIPS AND TRICKS:** The Test button is also placed on the Action panel in the Event list. Thus, you can check the Actions without opening the Event editor.

#### Delay the Action

In most cases the Action is performed immediately after the Condition is detected. But sometimes a delay is necessary between the Condition and the Action. Therefore, the new Event manager contains the Delay panel which allows that feature with below settings:

- **No delay:** when the Condition is detected, the Action is launched.
- **Simple delay:** when the Condition is detected, the Action is launched after the set time interval.
- **Still exists:** when the Condition is detected, the Action is launched after the set time interval only if the Condition still exists.
- **Continuously exists:** when the Condition is detected, the Action is launched after the set time interval only if the Condition has been existing continuously.

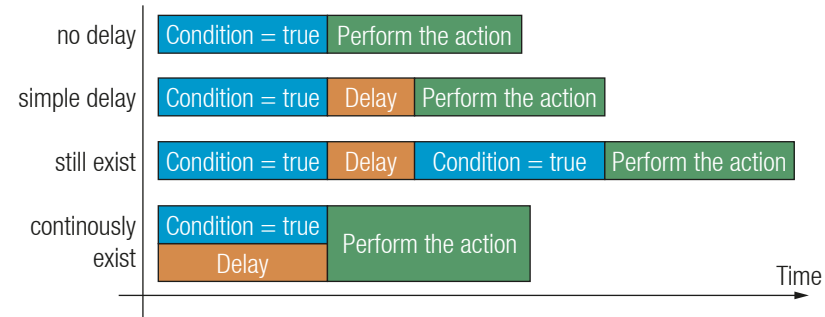

**The Available Delay Settings of an Event**

**TIPS AND TRICKS:** **Show advanced expressions** option is a useful tool when you look for the path or value of a property but just the expression is displayed. The option is available in the Event list window or when Link tool is used.

### 5.8.4. Clear One or More Event(s)

#### Clear an Event

Press the **Clear** button in the Event list or in the header section in the Event editor.

#### Clear all Events

When all the Events must be cleared press the **Load factory defaults** button above the Event list. You will be prompted to confirm the process.

### 5.8.5. Export and Import Events

The feature allows saving all the Events. The backup file can be uploaded to the same device type.

#### Export all the Events

**Step 1.** Press the **Export** button above the Event list.

**Step 2.** The Save as dialog box will appear. Set the desired folder and file name, then press the **Save** button.

The generated file is a simple text file which contains LW3 protocol commands. The file can be viewed by a simple text editor, e.g. Notepad.

**ATTENTION!** Editing the file is recommended only for expert users.

#### Import all the Events

**Step 1.** Press the **Import** button above the Event list.

**Step 2.** The Open dialog box will appear. Select the desired folder and file, then press the **Open** button.

## 5.9. Settings Menu

### 5.9.1. Status Tab

The most important hardware and software related information can be found on this tab: hardware and firmware version, serial numbers, temperatures, operation time, voltage information, and fan status. Device label can be changed to unique description by the **Set** button.

General	
Product name	HDMI20-OPTC-TX220-PRO
MAC address	a8:d2:36:00:36:0a
Hardware version	V11_AAA0
Device label	HDMI20-OPTC-TX220 <input type="button" value="Set"/>
Part number	91550045
Serial number	ETALON_7A105530
Front panel HW version	V10_CAB0

Remote	
Remote device	HDMI20-OPTC-RX220-PRO
Remote serial	ETALON_7A105525

Operation	
System uptime	4595
Operation time	101191
High temperature operation time	0

Firmware version	
CPU firmware version	1.1.2b3 r41
Video MCU #1 version	1.1.2b3 r36
Video MCU #2 version	1.1.2b3 r36

Temperatures	
CPU temperature	49 °C (22 °C min, 52 °C max)
System temperature	49 °C (23 °C min, 52 °C max)
Air intake temperature	38.7 °C (22 °C min, 41 °C max)
Video chip temperature	47 °C (19 °C min, 49.99 °C max)
Ethernet switch temperature	35.99 °C (19 °C min, 45.58 °C max)
Video MCU #1 temperature	49 °C (22.17 °C min, 51 °C max)
Video MCU #2 temperature	40 °C (18.01 °C min, 44.5 °C max)

Voltages	
Main 5V	5.06 V (5.04 V min, 5.09 V max)
Main 3.3V	3.32 V (3.31 V min, 3.33 V max)
Video chip #1 1.3V	1.31 V (1.31 V min, 1.32 V max)
Video chip #1 1.2V	1.18 V (1.18 V min, 1.2 V max)
Video chip #2 1.3V/1	1.27 V (1.27 V min, 1.28 V max)

### 5.9.2. Network Tab

IP address and DHCP settings can be set on this tab. Always press the **Apply changes** button to save changes. Factory default settings can be recalled with a dedicated button.

General	
Current IP address	192.168.0.101
Current subnet mask	255.255.255.0
Current gateway address	192.168.0.1
Obtain IP address automatically (DHCP, AutoIP)	<input type="radio"/>
Static IP address	<input type="text" value="192.168.0.101"/>
Static subnet mask	<input type="text" value="255.255.255.0"/>
Static gateway address	<input type="text" value="192.168.0.1"/>
LW2 port	10001
LW3 port	6107
HTTP port	80
Apply changes	<input type="button" value="Apply changes"/> <input type="button" value="Cancel"/> <input type="button" value="Load factory defaults"/>

### 5.9.3. Front Panel Tab

Certain settings in connection with the front panel LCD are available in the LDC as well.

Front panel settings	
LCD Brightness	5 <input type="range" value="5"/>
Lock front panel	<input checked="" type="checkbox"/>
Dark mode enable	<input checked="" type="checkbox"/>
Dark mode enable on remote device	<input checked="" type="checkbox"/>

When Dark mode is enabled, all LEDs on the unit switch OFF after 1 minute, if no buttons are pressed. Pressing any button brings back status info on LEDs without performing the function of the button itself. Dark mode has to be enabled on TX and RX separately.

- **LCD brightness:** the slider can be set from 0 to 10. When the value is 0, the LCD is totally dark.
- **Lock front panel:** disables the control functions (button and jog dial knob) on the front panel.
- **Enable dark mode:** enable/disable lighting of the LEDs on the front panel of transmitter. See more about the dark mode in [Front Panel Submenu](#) section. The LEDs switch off after 60 s delay.
- **Enable dark mode on a remote device\*:** turn on/off the lighting of the LEDs on the front panel of the receiver (which connected directly to the transmitter via fiber).

\*Remote setting of the dark mode is available only in the transmitter.

### 5.9.4. Backup Tab (Configuration Cloning)

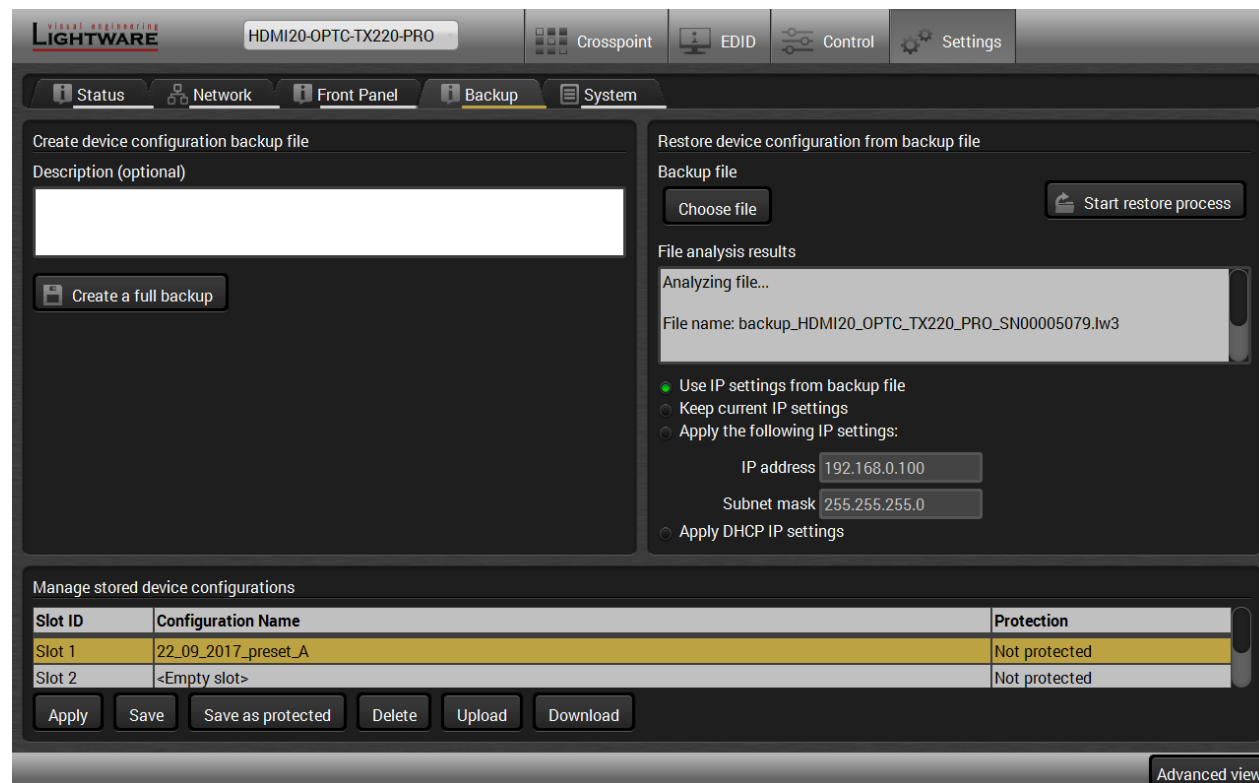

**Backup tab**

The configuration cloning of Lightware LW3 devices is a simple method that eliminates the need to repeatedly configure certain devices to have identical (non-factory) settings. If the devices are installed in the same type of system multiple times then it is enough to set up only one device to fit the user's needs and then copy those settings to the others, thus saving time and resources.

#### Cloning Steps in a Nutshell

Installing multiple devices with the same customized configuration settings can be done in a few easy steps:

- Step 1.** Configure one device with all your desired settings with the LDC software.
- Step 2.** Backup the full configuration file to your computer.
- Step 3.** If needed, make some modifications to the configuration file using a text editor (e.g. Notepad). E.g. modifying the static IP address is needed when DHCP is not used.
- Step 4.** Connect to the other device which has to be configured and upload (restore) your configuration file.
- Step 5.** Done! You can have as many totally identical, customized devices as you like.

#### Save the Settings of the Device (Backup)

- Step 1.** Apply the desired settings in the extender (port parameters, crosspoint, etc.)
- Step 2.** Select the **Settings / Backup** tab from the menu.
- Step 3.** Write a short **description** in the text box on the left (optional).
- Step 4.** Press the **Create a full backup** button. You will be prompted to save the file to the computer. The default file name is the following:

BACKUP\_<DEVICE TYPE>\_SN<SERIAL NUMBER>.LW3

- Step 5.** Set the desired **file name**, select the folder and **save** the file.

**TIPS AND TRICKS:** Using the exact product type in the filename is recommended since it makes the file usage more comfortable.

#### About the Backup File

The backup file is a simple text file which contains LW3 protocol commands. The first line is the description, and the further lines are the commands which will be executed during the restore process. The file can be viewed (and/or edited) by a simple text editor, e.g. Notepad.

**ATTENTION!** Editing the command lines is only recommended for expert users.

#### Upload the Settings to a Device (Restore)

**WARNING!** Please note that the settings will be permanently overwritten with the restored parameters in the device. Withdrawal is not possible.

**ATTENTION!** The cloning is successful when the backup file is downloaded from the same type of source device as the destination device.

#### The Restoring Process

- Step 1.** Select the **Settings / Backup** tab from the menu.
- Step 2.** Click on the **Choose file** button on the right panel and **browse** the desired file.
- Step 3.** The file is checked and the result will be displayed in the textbox below. If the file is correct, the settings can be restored.
- Step 4.** Choose **IP settings** what you want to use after backup. You can apply settings from the backup file, keep actual settings, set it manually in a dialog box or apply DHCP.
- Step 5.** Press the **Start restore process** button and click on the **Yes** button when asked.



### Create and Restore Backups from the Device Memory

HDMI20-OPTC series extenders are able to store backups in their own memory and these can be recalled from there so user does not need to save backup files to the local computer. Four slots are available for this purpose.

Slot ID	Configuration Name	Protection
Slot 1	Preset_0720	Not protected
Slot 2	backup_0125	Protected
Slot 3	<Empty slot>	Not protected
Slot 4	<Empty slot>	Not protected

Buttons: Apply, Save, Save as protected, Delete, Upload, Download

You can save presets as not protected with using **Save** button and as protected with using the **Save as protected** button. To restore a preset select the slot of the desired backup and click on the **Apply** button. You can save presets from a file from your local computer by clicking on the **Upload** button and you can also save a preset from the device's memory to a backup file with using the **Download** button. If you do not need a saved preset any more, select it and click on the **Delete** button.

**WARNING! Loading factory default settings will erase not protected presets which have been saved in the device memory!**

#### 5.9.5. System

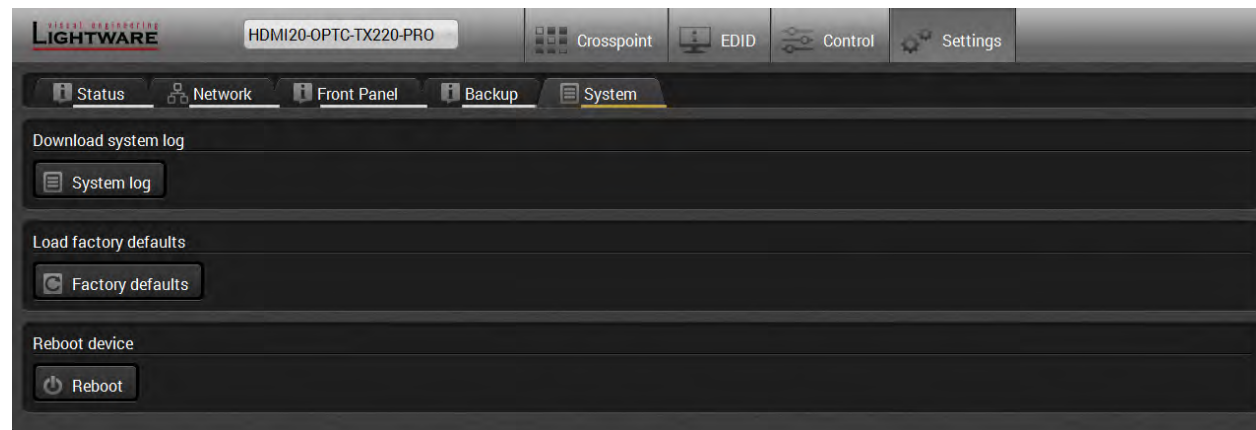

Three functions are available under System tab:

- **Download system log** - saving the log file of the device.
- **Load factory defaults** - recalling factory defaults settings and values. All factory default settings are listed in the [Factory Default Settings](#) section.
- **Reboot** - rebooting the system.

### 5.10. Advanced View Window

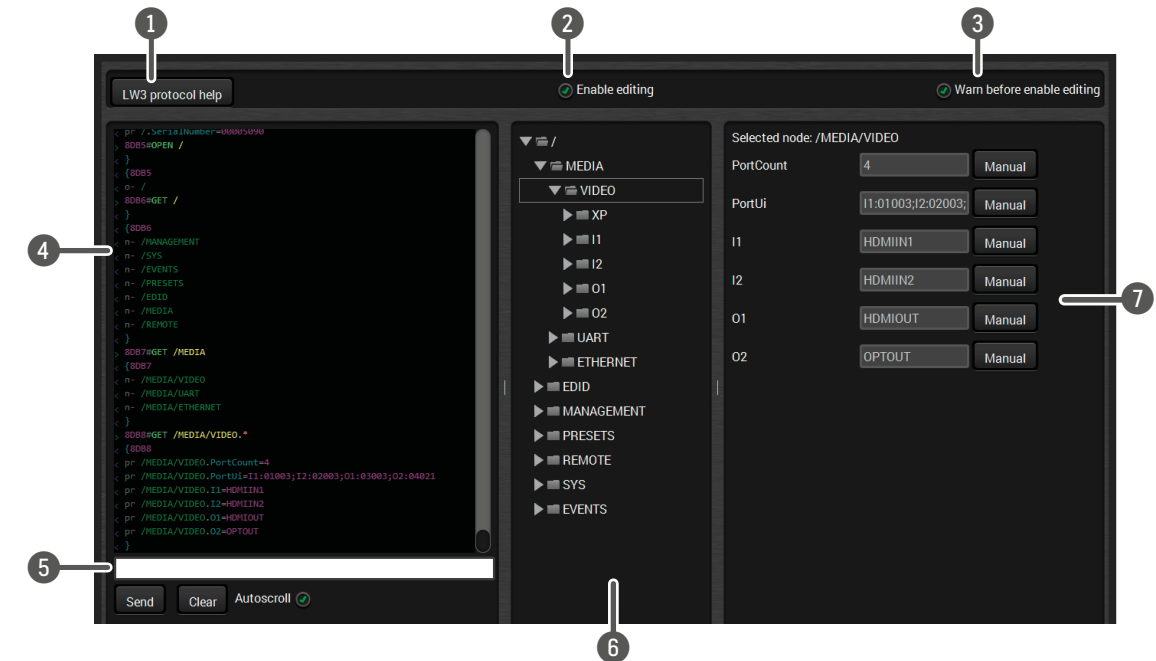

- LW3 protocol help** Pushing the button results a help window opening which describes the most important information about LW3 protocol commands in HTML format.
- Edit mode** The default appearance is the read-only mode. If you want to modify the values or parameters, tick the option. You will be prompted to confirm your selection.
- Warning mode** If this pipe checked in, a warning window pops up when you enable Edit mode.
- Terminal window** Commands and responses with time and date are listed in this window. Sent command starts with '>' character, received response starts with '<' character. The color of each item depends on the type of the command and response. The content of the window can be emptied by the **Clear** button. If the **Autoscroll** option is ticked, the list is scrolled automatically when a new line is added.
- Command line** Type the desired command and execute it by the **Send** button. .
- Protocol tree** LW3 protocol tree; select an item to see its content.
- Node list** Correspondent parameters and nodes are shown which are connected to the selected item in the protocol tree.
  - Manual button:** Manual (short description) of the node can be called and displayed in the terminal window.
  - Set button:** Saves the value/parameter typed in the textbox.
  - Call button:** Calls the method, e.g. reloads factory default settings.

# 6

## LW3 Programmers' Reference

The device can be controlled through Lightware 3 (LW3) protocol commands to ensure the compatibility with other Lightware products. The supported LW3 commands are described in this chapter.

- ▶ [OVERVIEW](#)
- ▶ [PROTOCOL RULES](#)
- ▶ [SYSTEM COMMANDS](#)
- ▶ [VIDEO PORT AND CROSSPOINT SETTINGS](#)
- ▶ [NETWORK CONFIGURATION](#)
- ▶ [RS-232 PORT CONFIGURATION](#)
- ▶ [SENDING MESSAGE VIA THE COMMUNICATION PORTS](#)
- ▶ [EDID MANAGEMENT](#)
- ▶ [LW3 COMMANDS - QUICK SUMMARY](#)

### 6.1. Overview

The Lightware Protocol #3 (LW3) is implemented in almost all new Lightware devices (matrix switchers, signal extenders and distribution amplifiers) since 2012. The protocol is ASCII-based and all commands are terminated with a carriage return (Cr, '\r') and line feed (Lf, '\n') pair. It is organized as a tree structure that provides outstanding flexibility and user-friendly handling with 'nodes', 'properties' and 'methods'. The **Advanced View** of the Lightware Device Controller software is the perfect tool for browsing and learning how the LW3 protocol can be used in practice.

### 6.2. Protocol Rules

#### 6.2.1. LW3 Tree Structure and Command Structure (examples)

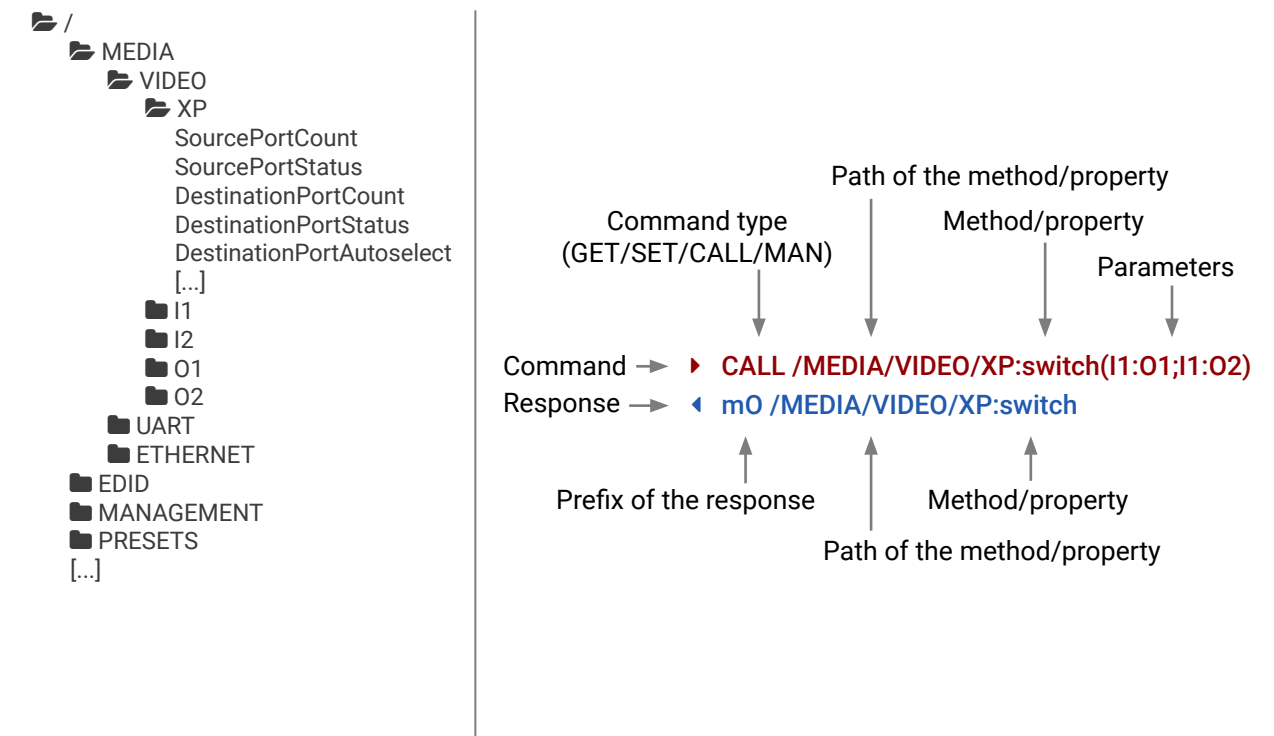

#### 6.2.2. General Rules

- All names and parameters are **case-sensitive**.
- The nodes are separated by a slash (/) character.
- The node name can contain the elements of the English alphabet and numbers.
- Use the **TCP port no. 6107** when using LW3 protocol over Ethernet.
- When a command is issued by the device, the received response cannot be processed by the CPU.
- The node paths describe the exact location of the node, listing each parent node up to the root.

### 6.2.3. Command Types

#### GET command

The **GET** command can be used to get the child nodes, properties and methods of a specific node. It can also be used to get the value of a property. Use the dot character (.) when addressing a property:

- ▶ **GET /.SerialNumber**
- ◀ **pr /.SerialNumber=87654321**

#### GETALL command

The **GETALL** command can be used to get all child nodes, properties and methods of a node with one command.

- ▶ **GETALL /MEDIA/UART**
- ◀ **ns /MEDIA/UART/P1**
- ◀ **ns /MEDIA/UART/P2**
- ◀ **pr /MEDIA/UART.PortCount=2**
- ◀ **pr /MEDIA/UART.PortUi=P1:12209;P2:12224**
- ◀ **pr /MEDIA/UART.P1=Local RS-232**
- ◀ **pr /MEDIA/UART.P2=TPS out RS-232**

#### SET command

The **SET** command can be used to modify the value of a property. Use the dot character (.) when addressing the property:

- ▶ **SET /MEDIA/VIDEO/I1.ColorSpaceMode=0**
- ◀ **pw /MEDIA/VIDEO/I1.ColorSpaceMode=0**

#### CALL command

A method can be invoked by the **CALL** command. Use the colon character (:) when addressing the method:

- ▶ **CALL /MEDIA/VIDEO/XP:switch(I1:01)**
- ◀ **mO /MEDIA/VIDEO/XP:switch**

#### MAN command

The manual is a human readable text that describes the syntax and provides a hint for how to use the primitives. For every node, property and method in the tree there is a manual, type the MAN command to get the manual:

- ▶ **MAN /MEDIA/VIDEO/O1.Pwr5vMode**
- ◀ **pm /MEDIA/VIDEO/O1.Pwr5vMode ["0" | "1" | "2"] 0 - Auto, 1 - Always On, 2 - Always Off**

### 6.2.4. Prefix Summary

**DEFINITION:** The prefix is a 2-character long code that describes the type of the response.

The following prefixes are defined in the LW3 protocol:

Prefix	Description	Prefix	Description
n-	a node	pm	a manual for the property
nE	an error for a node	m-	a method
nm	a manual for a node	mO	a response after a success method execution
pr	a read-only property	mF	a response after a failed method execution
pw	read-write property	mE	an error for a method
pE	an error for the property	mm	a manual for a method

### 6.2.5. Error Messages

There are several error messages defined in the LW3 protocol, all of them have a unique error number.

- ▶ **CALL /MEDIA/VIDEO/XP:switch(IA:01)**
- ◀ **mE /MEDIA/VIDEO/XP:switch %E004:Invalid value**

### 6.2.6. Escaping

**DEFINITION:** An escape sequence is a sequence of characters that does not represent itself when used inside a character or string literal, but is translated into another character or a sequence of characters.

Property values and method parameters can contain characters which are used as control characters in the protocol. They must be escaped. The escape character is the backslash (\) and escaping means injecting a backslash before the character that should be escaped (like in C language).

Control characters are the following: \ { } # % ( ) \r \n \t

The **original** message:      **CALL /MEDIA/UART/P1:sendMessage(Set(01))**

The **escaped** message:      **CALL /MEDIA/UART/P1:sendMessage(Set\01\))**

### 6.2.7. Signature

**DEFINITION:** The signature is a four-digit-long hexadecimal value that can be optionally placed before every command to keep a command and the corresponding responses together as a group.

Each line is terminated with a carriage return (Cr, '\r') and line feed (Lf, '\n') characters. In several cases the number of the lines in the response cannot be determined in advance, e.g. the client intends to receive for the whole response and also wants to be sure, that the received lines belong together and to the same command. In these cases, a special feature the 'signature' can be used. The response to that particular command will also be preceded by the signature, and the corresponding lines will be between brackets:

```
▶ 1700#GET /EDID.*
◀ {1700
◀ pr /EDID.EdidStatus=F89:E1;D1:E2;D1:E3;D1:E4;F89:E5
◀ m- /EDID:copy
◀ m- /EDID:delete
◀ m- /EDID:reset
◀ m- /EDID:switch
◀ m- /EDID:switchAll
◀ }
```

**INFO:** The lines of the signature are also Cr and Lf terminated.

### 6.2.8. Subscription

**DEFINITION:** Subscription to a node means that the user will get a notification if a property of the node changes.

A user can subscribe to any node. These notifications are asynchronous messages and are useful to keep the client application up to date, without having to periodically poll the node to detect a changed property. When the user does not want to be informed about the changes anymore, he can simply unsubscribe from the node.

**ATTENTION!** The subscriptions are handled separately for connections. Hence, if the connection is terminated all registered subscriptions are deleted. After reopening a connection all subscribe commands have to be sent in order to get the notifications of the changes on that connection.

#### Subscribe to a Node

```
▶ OPEN /MEDIA/VIDEO
◀ o- /MEDIA/VIDEO
```

#### Get the Active Subscriptions

```
▶ OPEN
◀ o- /MEDIA/VIDEO
◀ o- /EDID
◀ o- /DISCOVERY
```

#### Subscribe to Multiple Nodes

```
▶ OPEN /MEDIA/VIDEO/*
◀ o- /MEDIA/VIDEO/*
```

#### Unsubscribe from a Node

```
▶ CLOSE /MEDIA/VIDEO
◀ c- /MEDIA/VIDEO
```

#### Unsubscribe from Multiple Nodes

```
▶ CLOSE /MEDIA/VIDEO/*
◀ c- /MEDIA/VIDEO/*
```

### 6.2.9. Notifications about the Changes of the Properties

When the value of a property is changed and the user is subscribed to the node, which the property belongs to, an asynchronous notification is generated. This notification is called as the 'change message'. The format of such a message is very similar to the response for the **GET** command:

```
◀ CHG /EDID.EdidStatus=F48:E1
```

#### A Short Example of How to Use the Subscription

There are two independent users controlling the device through two independent connections (**Connection #1** and **Connection #2**). The events in the rows occur after each other.

```
▶ OPEN /MEDIA/VIDEO/QUALITY
◀ o- /MEDIA/VIDEO/QUALITY
▶ GET /MEDIA/VIDEO/Quality.QualityMode
◀ pm /MEDIA/VIDEO/QUALITY.QualityMode=graphic
▶ GET /MEDIA/VIDEO/Quality.QualityMode
◀ pm /MEDIA/VIDEO/QUALITY.QualityMode=graphic
▶ SET /MEDIA/VIDEO/Quality.QualityMode=video
◀ pw /MEDIA/VIDEO/QUALITY.QualityMode=video
◀ CHG /MEDIA/VIDEO/QUALITY.QualityMode=video
```

} Connection #1  
} Connection #2  
→ Connection #1

**Explanation:** The first user (**Connection #1**) set a subscription to a node. Later the other user (**Connection #2**) made a change, and thanks for the subscription, the first user got a notification about the change.

### 6.2.10. Legend for the Control Commands

Format	Description
<in>	Input port number
<out>	Output port number
<port>	Input or output port number
<loc>	Location number
<parameter>	Variable, which is defined and described in the command
<expression>	Batched parameters: the underline means that more expressions or parameters can be placed by using a semicolon, e.g. <u>I2;I4;I5</u> or <u>F27:E1;F47:E2</u>
▶	Sent command
◀	Received response
•	Space character

## 6.3. System Commands

### 6.3.1. Querying the Product Name

The name of the product is a read-only parameter and cannot be modified.

#### Command and Response

- ▶ GET•/.ProductName
- ◀ pr•/.ProductName=<Product\_name>

#### Example

- ▶ GET /.ProductName
- ◀ pr /.ProductName=HDMI20-OPTC-TX220-PRO

### 6.3.2. Setting the Device Label

**ATTENTION!** The device label can be changed to a custom text which is displayed in many windows of the LDC. This writable parameter is not the same as the ProductName parameter.

#### Command and Response

- ▶ SET•/MANAGEMENT/UID/DeviceLabel=<Custom\_name>
- ◀ pw•/MANAGEMENT/UID/DeviceLabel=<Custom\_name>

The Device Label can be 39 character length and ASCII characters are allowed. Longer names are truncated.

#### Example

- ▶ SET /MANAGEMENT/UID.DeviceLabel=HDM20-OPTC\_Control\_room
- ◀ pw /MANAGEMENT/UID.DeviceLabel=HDM20-OPTC\_Control\_room

### 6.3.3. Querying the Serial Number

#### Command and Response

- ▶ GET•/.SerialNumber
- ◀ pr•/.SerialNumber=<serial\_nr>

#### Example

- ▶ GET /.SerialNumber
- ◀ pr /.SerialNumber=92345083

### 6.3.4. Querying the Firmware Version

#### Command and Response

- ▶ GET•/SYS/MB.FirmwareVersion
- ◀ pr•/SYS/MB.FirmwareVersion=<firmware\_version>

#### Example

- ▶ GET /SYS/MB.FirmwareVersion
- ◀ pr /SYS/MB.FirmwareVersion=1.2.0b10 r9

### 6.3.5. Resetting the Extender

The extender can be restarted – the current connections (LAN, RS-232) will be terminated.

#### Command and Response

- ▶ CALL•/SYS:reset()
- ◀ mO•/SYS:reset=

#### Example

- ▶ CALL /SYS:reset()
- ◀ mO /SYS:reset=

### 6.3.6. Restoring the Factory Default Settings

#### Command and Response

- ▶ CALL•/SYS:factoryDefaults()
- ◀ mO•/SYS:factoryDefaults=

#### Example

- ▶ CALL /SYS:factoryDefaults()
- ◀ mO /SYS:factoryDefaults=

### 6.3.7. Locking Front Panel

#### Command and Response

- ▶ SET•/MANAGEMENT/UI.ControlLock=<lock\_status>
- ◀ pw•/MANAGEMENT/UI.ControlLock=<lock\_status>

#### Example

- ▶ SET /MANAGEMENT/UI.ControlLock=1
- ◀ pw /MANAGEMENT/UI.ControlLock=1

#### Parameters

- <lock\_status> **0:** None - All functions of the front panel button are enabled.
- 1:** Locked - The front panel button is locked.
- 2:** Force Locked - The front panel button is locked and unlock is only possible via protocol command.

### 6.3.8. Enabling Dark Mode

#### Command and Response

- ▶ SET•/MANAGEMENT/UI.DARKMODE.DarkModeEnable=<dark\_mode\_status>
- ◀ pw•/MANAGEMENT/UI.DARKMODE.DarkModeEnable=<dark\_mode\_status>

#### Parameters

- <dark\_mode\_status> **true:** The LEDs and the brightness of LCD display on the extender are turned on.
- false:** The LEDs and the brightness of LCD display on the extender are turned off.

#### Example

- ▶ SET /MANAGEMENT/UI/DARKMODE.DarkModeEnable=true
- ◀ pw /MANAGEMENT/UI/DARKMODE.DarkModeEnable=true

### 6.3.9. Setting the Dark Mode Delay

The LEDs turn off after the dark mode is enabled. The delay time can be set (the default value is 60s).

#### Command and Response

- ▶ SET•/MANAGEMENT/UI.DARKMODE.DarkModeDelay=<delay\_sec>
- ◀ pw•/MANAGEMENT/UI.DARKMODE.DarkModeDelay=<delay\_sec>

#### Example

- ▶ SET /MANAGEMENT/UI/DARKMODE.DarkModeDelay=10
- ◀ pw /MANAGEMENT/UI/DARKMODE.DarkModeDelay=10

When dark mode is enabled, the LEDs are turned off after 10s.

### 6.3.10. Setting the Dark Mode on the Remote Device

INFO: This command is available for the transmitter.

Dark mode on the receiver can be activated by sending a command to the transmitter.

#### Command and Response

- ▶ SET•/REMOTE/D1.DarkModeEnable=<dark\_mode\_status>
- ◀ pw•/REMOTE/D1.DarkModeEnable=<dark\_mode\_status>

#### Parameters

- <dark\_mode\_status> **true:** LEDs on the receiver are turned on.
- false:** LEDs on the receiver are turned off.

#### Example

- ▶ SET /REMOTE/D1.DarkModeEnable=true
- ◀ pw /REMOTE/D1.DarkModeEnable=true

### 6.3.11. Setting the Rotary Direction of the Jog Dial Knob

#### Command and Response

- ▶ SET•/MANAGEMENT/UI.RotaryDirection=<direction>
- ◀ pw•/MANAGEMENT/UI.RotaryDirection=<direction>

#### Parameters

- <direction> **0:** The rotary direction of down is clockwise.
- 1:** The rotary direction of down is counter clockwise.

#### Example

- ▶ SET /MANAGEMENT/UI.RotaryDirection=0
- ◀ pw /MANAGEMENT/UI.RotaryDirection=0

## 6.4. Video Port and Crosspoint Settings

### 6.4.1. Querying the Crosspoint Setting

#### Command and Response

- ▶ GET•/MEDIA/VIDEO/XP.DestinationConnectionList
- ◀ pr•/MEDIA/VIDEO/XP.DestinationConnectionList=<out1\_state>;<out2\_state>

#### Example

- ▶ GET /MEDIA/VIDEO/XP.DestinationConnectionList
- ◀ pr /MEDIA/VIDEO/XP.DestinationConnectionList=I1;I1

I1 input port is connected to all output ports.

### 6.4.2. Switching Video Input

#### Command and Response

- ▶ CALL•/MEDIA/VIDEO/XP:switch(<in>:<out>)
- ◀ mO•/MEDIA/VIDEO/XP:switch

#### Example

- ▶ CALL /MEDIA/VIDEO/XP:switch(I1:O1)
- ◀ mO /MEDIA/VIDEO/XP:switch

### 6.4.3. Muting Input Port

#### Command and Response

- ▶ CALL•/MEDIA/VIDEO/XP:muteSource(<in>)
- ◀ mO•/MEDIA/VIDEO/XP:muteSource

#### Example

- ▶ CALL /MEDIA/VIDEO/XP:muteSource(I1)
- ◀ mO /MEDIA/VIDEO/XP:muteSource

### 6.4.4. Unmuting Input Port

#### Command and Response

- ▶ CALL•/MEDIA/VIDEO/XP:unmuteSource(<in>)
- ◀ mO•/MEDIA/VIDEO/XP:unmuteSource

#### Example

- ▶ CALL /MEDIA/VIDEO/XP:unmuteSource(I1)
- ◀ mO /MEDIA/VIDEO/XP:unmuteSource

### 6.4.5. Locking Input Port

#### Command and Response

- ▶ CALL•/MEDIA/VIDEO/XP:lockSource(<in>)
- ◀ mO•/MEDIA/VIDEO/XP:lockSource

#### Example

- ▶ CALL /MEDIA/VIDEO/XP:lockSource(I1)
- ◀ mO /MEDIA/VIDEO/XP:lockSource

### 6.4.6. Unlocking Input Port

#### Command and Response

- ▶ CALL•/MEDIA/VIDEO/XP:unlockSource(<in>)
- ◀ mO•/MEDIA/VIDEO/XP:unlockSource

#### Example

- ▶ CALL /MEDIA/VIDEO/XP:unlockSource(I1)
- ◀ mO /MEDIA/VIDEO/XP:unlockSource

### 6.4.7. HDCP Setting

This setting allows to send non-encrypted content to a non-HDCP compliant display. See more information in [HDCP Management](#) section.

#### Command and Response

- ▶ SET•/MEDIA/VIDEO/<in>.HdcpVersion=<hdcp\_version>
- ◀ pw•/MEDIA/VIDEO/<in>.HdcpVersion=<hdcp\_version>

#### Parameters

- 0: Disable HDCP on input
- 1: Allow HDCP 1.4 only
- 2: Allow HDCP 2.2 and HDCP 1.4

#### Example

- ▶ SET /MEDIA/VIDEO/I1.HdcpVersion=0
- ◀ pw /MEDIA/VIDEO/I1.HdcpVersion=0

### 6.4.8. Querying the Status of Source Ports

#### Command and Response

- ▶ GET•/MEDIA/VIDEO/XP.SourcePortStatus
- ◀ pr•/MEDIA/VIDEO/XP.SourcePortStatus=<in1\_state>;<in2\_state>

The response contains 5 ASCII characters for each port. The first character indicates the mute/lock state, the next four characters represent a 2-byte HEX code showing the current state of the input ports.

#### Example

- ▶ GET /MEDIA/VIDEO/XP.SourcePortStatus
- ◀ pr /MEDIA/VIDEO/XP.SourcePortStatus=T008F;T008A

#### Parameters

Letter (Character 1)		
	Mute state	Lock state
T	Unmuted	Unlocked
L	Unmuted	Locked
M	Muted	Unlocked
U	Muted	Locked

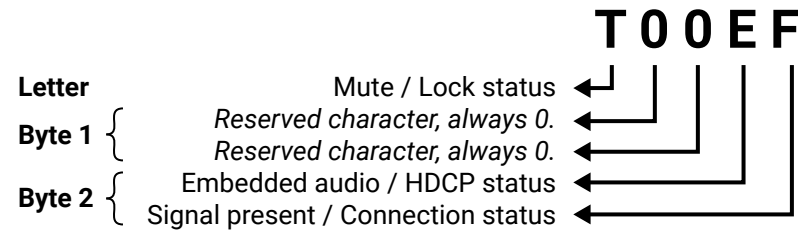

	Byte 1				Byte 2			
	Character 2		Character 3		Character 4		Character 5	
	BIT 7-6	BIT 5-4	BIT 3-2	BIT 1-0	BIT 7-6	BIT 5-4	BIT 3-2	BIT 1-0
	Reserved	Reserved	Reserved	Reserved	Embedded audio status	HDCP status	Signal present status	Connection status
00					Unknown			
01					Reserved			
10	Reserved	Reserved	Reserved	Reserved	No embedded audio	Not encrypted	No signal	Not connected
11					Embedded audio presents	Encrypted	Signal presents	Connected

#### Example and Explanation (T008F):

T	0		0		8		F	
Unlocked, Unmuted	00	00	00	00	10	00	11	11
	Reserved	Reserved	Reserved	Reserved	No embedded audio	Unknown	Signal presents	Connected

### The Most Common Received Port Status Responses

T00AA	T	0		0		A		A	
	Unlocked, Unmuted	00	00	00	00	10	10	10	10
	Reserved	Reserved	Reserved	Reserved	No embedded audio	Not encrypted	No signal	Not connected	

T00AB	T	0		0		A		B	
	Unlocked, Unmuted	00	00	00	00	10	10	10	11
	Reserved	Reserved	Reserved	Reserved	No embedded audio	Not encrypted	No signal	Connected	

T00AF	T	0		0		A		F	
	Unlocked, Unmuted	00	00	00	00	10	10	11	11
	Reserved	Reserved	Reserved	Reserved	No embedded audio	Not encrypted	Signal presents	Connected	

T00EF	T	0		0		E		F	
	Unlocked, Unmuted	00	00	00	00	11	10	11	11
	Reserved	Reserved	Reserved	Reserved	Embedded audio presents	Not encrypted	Signal presents	Connected	

T00BF	T	0		0		B		F	
	Unlocked, Unmuted	00	00	00	00	10	11	11	11
	Reserved	Reserved	Reserved	Reserved	No embedded audio	Encrypted	Signal presents	Connected	

T00FF	T	0		0		F		F	
	Unlocked, Unmuted	00	00	00	00	11	11	11	11
	Reserved	Reserved	Reserved	Reserved	Embedded audio presents	Encrypted	Signal presents	Connected	



### 6.4.9. Querying the Status of Destination Ports

#### Command and Response

- ▶ GET•/MEDIA/VIDEO/XP.DestinationPortStatus
- ◀ pr•/MEDIA/VIDEO/XP.DestinationPortStatus=<out1\_state>;<out2\_state>

The response contains 5 ASCII characters for each port. The first character indicates the mute/lock state, the next 2-byte long HEX code showing the current state of the output port.

#### Parameters

See at previous section.

#### Example

- ▶ GET /MEDIA/VIDEO/XP.DestinationPortStatus
- ◀ pr /MEDIA/VIDEO/XP.DestinationPortStatus=T008E;M008E

#### Example and Explanation (M008E)

M	0		0		8		E	
Unlocked, Muted	00	00	00	00	10	00	11	10
	Reserved	Reserved	Reserved	Reserved	No embedded audio	Unknown	Signal presents	Connected

### 6.4.10. Querying the Video Autoselect Settings

#### Command and Response

- ▶ GET•/MEDIA/VIDEO/XP.DestinationPortAutoselect
- ◀ pr•/MEDIA/VIDEO/XP.DestinationPortAutoselect=<out1\_set>;<out2\_set>

The response shows the settings of output1 and output2.

#### Parameters

Identifier	Parameter description		Parameter values
<out#_set>	Two-letter code of the Autoselect settings	1 <sup>st</sup> letter	<b>E</b> : Autoselect is enabled <b>D</b> : Autoselect is disabled
		2 <sup>nd</sup> letter	<b>F</b> : First detect mode: the first active video input is selected. <b>P</b> : Priority detect: always the highest priority active video input will be selected. <b>L</b> : Last detect: always the last attached input is switched to the output automatically.

#### Example

- ▶ GET /MEDIA/VIDEO/XP.DestinationPortAutoselect
- ◀ pr /MEDIA/VIDEO/XP.DestinationPortAutoselect=EP;EP

EP: the Autoselect is Enabled on output 1 and output 2, selected mode is Priority detect.

### 6.4.11. Changing the Autoselect Mode

#### Command and Response

- ▶ CALL•/MEDIA/VIDEO/XP:setDestinationPortAutoselect(<out>;<out\_set>)
- ◀ mO•/MEDIA/VIDEO/XP.setDestinationPortAutoselect

#### Parameters

See the previous legend.

#### Example1

- ▶ CALL /MEDIA/VIDEO/XP:setDestinationPortAutoselect(O2:D)
- ◀ mO /MEDIA/VIDEO/XP:setDestinationPortAutoselect

D: the Autoselect is disabled on output 2.

#### Example2

- ▶ CALL /MEDIA/VIDEO/XP:setDestinationPortAutoselect(O1:EF)
- ◀ mO /MEDIA/VIDEO/XP:setDestinationPortAutoselect

EF: First priority detect is set on output 1.

### 6.4.12. Setting the Output Conversion Mode

INFO: This command is available on the O1 output of HDMI20-OPTC-RX220-PRO model.

#### Command and Response

- ▶ SET•/MEDIA/VIDEO/O1.Conversion=<conversion\_mode>
- ◀ mO•/MEDIA/VIDEO/O1.Conversion=<conversion\_mode>

#### Parameters

<conversion\_mode>    **OFF**: No conversion mode (transparent)  
**420**: Converts to YCbCr 4:2:0  
**LEFT**: Split mode, output on the left side  
**RIGHT**: Split mode, output on the right side

#### Example

- ▶ SET /MEDIA/VIDEO/O1.Conversion=420
- ◀ pw /MEDIA/VIDEO/O1.Conversion=420

HDMI signal on the O1A and O1B of the receiver is downsampled to YCbCr 4:2:0. For more information see [Output Conversion Modes](#) section.

### 6.4.13. Setting the Output Conversion Mode of the Remote Device

INFO: This command is available in transmitters.

Output conversion mode on the O1A and O1B ports of the receiver can be also set by sending a command to the transmitter.

#### Command and Response

- ▶ SET•/REMOTE/D1.Conversion=<conversion\_mode>
- ◀ pw•/REMOTE/D1.Conversion=<conversion\_mode>

#### Parameters

See in the previous section.

#### Example

- ▶ SET /REMOTE/D1.Conversion=LEFT
- ◀ pw /REMOTE/D1.Conversion=LEFT

HDMI signal is split on the O1A (left) and O1B (right) ports of the receiver. For more information see [Output Conversion Modes](#) section.

## 6.5. Network Configuration

### 6.5.1. Querying the IP Address

#### Command and Response

- ▶ GET•/MANAGEMENT/NETWORK.IpAddress
- ◀ pr•/MANAGEMENT/NETWORK.IpAddress=<IP\_address>

#### Example

- ▶ GET /MANAGEMENT/NETWORK.IpAddress
- ◀ pr /MANAGEMENT/NETWORK.IpAddress=192.168.0.101

### 6.5.2. Changing the IP Address (Static)

#### Command and Response

- ▶ SET•/MANAGEMENT/NETWORK.StaticIpAddress=<IP\_address>
- ◀ pw•/MANAGEMENT/NETWORK.StaticIpAddress=<IP\_address>

#### Example

- ▶ SET /MANAGEMENT/NETWORK.StaticIpAddress=192.168.0.103
- ◀ pw /MANAGEMENT/NETWORK.StaticIpAddress=192.168.0.103

### 6.5.3. Querying the Subnet Mask

#### Command and Response

- ▶ GET•/MANAGEMENT/NETWORK.NetworkMask
- ◀ pr•/MANAGEMENT/NETWORK.NetworkMask=<netmask>

#### Example

- ▶ GET /MANAGEMENT/NETWORK.NetworkMask
- ◀ pr /MANAGEMENT/NETWORK.NetworkMask=255.255.255.0

### 6.5.4. Changing the Subnet Mask (Static)

#### Command and Response

- ▶ SET•/MANAGEMENT/NETWORK.StaticNetworkMask=<netmask>
- ◀ pw•/MANAGEMENT/NETWORK.StaticNetworkMask=<netmask>

#### Example

- ▶ SET /MANAGEMENT/NETWORK.StaticNetworkMask=255.255.255.0
- ◀ pw /MANAGEMENT/NETWORK.StaticNetworkMask=255.255.255.0

### 6.5.5. Querying the Gateway Address

#### Command and Response

- ▶ GET•/MANAGEMENT/NETWORK.GatewayAddress
- ◀ pr•/MANAGEMENT/NETWORK.GatewayAddress=<gw\_address>

#### Example

- ▶ GET /MANAGEMENT/NETWORK.GatewayAddress
- ◀ pr /MANAGEMENT/NETWORK.GatewayAddress=192.168.0.1

### 6.5.6. Changing the Gateway Address (Static)

#### Command and Response

- ▶ SET•/MANAGEMENT/NETWORK.StaticGatewayAddress=<gw\_address>
- ◀ pw•/MANAGEMENT/NETWORK.StaticGatewayAddress=<gw\_address>

#### Example

- ▶ SET /MANAGEMENT/NETWORK.StaticGatewayAddress=192.168.0.5
- ◀ pw /MANAGEMENT/NETWORK.StaticGatewayAddress=192.168.0.5

### 6.5.7. Querying the DHCP State

#### Command and Response

- ▶ GET•/MANAGEMENT/NETWORK.DhcpEnabled
- ◀ pw•/MANAGEMENT/NETWORK.DhcpEnabled=<dhcp\_state>

#### Example

- ▶ GET /MANAGEMENT/NETWORK.DhcpEnabled
- ◀ pw /MANAGEMENT/NETWORK.DhcpEnabled=true

### 6.5.8. Changing the DHCP State

#### Command and Response

- ▶ SET•/MANAGEMENT/NETWORK.DhcpEnabled=<dhcp\_state>
- ◀ pw•/MANAGEMENT/NETWORK.DhcpEnabled=<dhcp\_state>

#### Example

- ▶ SET /MANAGEMENT/NETWORK.DhcpEnabled=false
- ◀ pw /MANAGEMENT/NETWORK.DhcpEnabled=false

### 6.5.9. Enabling Ethernet Port

#### Command and Response

- ▶ SET•/MEDIA/ETHERNET/<eth\_port>.Enabled=<status>
- ◀ pw•/MEDIA/ETHERNET/<eth\_port>.Enabled=<status>

#### Example

- ▶ SET /MEDIA/ETHERNET/P2.Enabled=false
- ◀ pw /MEDIA/ETHERNET/P2.Enabled=false

Disabled the P2 Ethernet port.

## 6.6. RS-232 Port Configuration

### 6.6.1. Querying the RS-232 Operation Mode

#### Command and Response

- ▶ GET•/MEDIA/UART/P1.Rs232Mode
- ◀ pw•/MEDIA/UART/P1.Rs232Mode=<rs232\_mode>

#### Parameters

- <rs232\_mode> 0: Pass-through  
1: Control (local)  
2: Command injection (local)

#### Example

- ▶ GET /MEDIA/UART/P1.Rs232Mode
- ◀ pw /MEDIA/UART/P1.Rs232Mode

### 6.6.2. Setting the RS-232 Operation Mode

#### Command and Response

- ▶ SET•/MEDIA/UART/P1.Rs232Mode=<rs232\_mode>
- ◀ pw•/MEDIA/UART/P1.Rs232Mode=<rs232\_mode>

#### Parameters

See the previous legend.

#### Example

- ▶ SET /MEDIA/UART/P1.Rs232Mode=1
- ◀ pw /MEDIA/UART/P1.Rs232Mode=1

### 6.6.3. Setting the BAUD Rate

#### Command and Response

- ▶ SET•/MEDIA/UART/P1.Baudrate=<baudrate>
- ◀ pw•/MEDIA/UART/P1.Baudrate=<baudrate>

#### Parameters

Identifier	Parameter description	Parameter values
<baudrate>	Baud rate value	0: 4800; 1: 7200; 2: 9600; 3: 14400; 4: 19200; 5: 38400; 6: 57600; 7: 115200

#### Example

- ▶ SET /MEDIA/UART/P1.Baudrate=2
- ◀ pw /MEDIA/UART/P1.Baudrate=2

#### 6.6.4. Setting the Databit

##### Command and Response

- ▶ SET•/MEDIA/UART/P1.DataBits=<databit>
- ◀ pw•/MEDIA/UART/P1.DataBits=<databit>

##### Parameters

<databit>: 8 or 9

##### Example

- ▶ SET /MEDIA/UART/P1.DataBits=8
- ◀ pw /MEDIA/UART/P1.DataBits=8

#### 6.6.5. Setting the Stopbits

##### Command and Response

- ▶ SET•/MEDIA/UART/P1.StopBits=<stopbit>
- ◀ pw•/MEDIA/UART/P1.StopBits=<stopbit>

##### Parameters

<stopbit>    0: 1  
                   1: 1,5  
                   2: 2

##### Example

- ▶ SET /MEDIA/UART/P1.StopBits=0
- ◀ pw /MEDIA/UART/P1.StopBits=0

#### 6.6.6. Setting the Parity

##### Command and Response

- ▶ SET•/MEDIA/UART/P1.Parity=<parity>
- ◀ pw•/MEDIA/UART/P1.Parity=<parity>

##### Parameters

<parity>        0: no parity 1  
                   1: odd  
                   2: even

##### Example

- ▶ SET /MEDIA/UART/P1.Parity=0
- ◀ pw /MEDIA/UART/P1.Parity=0

#### 6.6.7. Enabling Command Injection Mode

##### Command and Response

- ▶ SET•/MEDIA/UART/P1.CommandInjectionEnable=<ci\_enable>
- ◀ pw•/MEDIA/UART/P1.CommandInjectionEnable=<ci\_enable>

##### Parameters

<ci\_enable>:    true: enabled  
                   false: disabled

##### Example

- ▶ SET /MEDIA/UART/P1.CommandInjectionEnable=true
- ◀ pw /MEDIA/UART/P1.CommandInjectionEnable=true

**ATTENTION!** The Command injection status is stored in another read-only property: /MEDIA/UART/<P<sub>i</sub>>.CommandInjectionStatus.

## 6.7. Sending Message via the Communication Ports

### 6.7.1. Sending Message via an RS-232 Port

The RS-232 ports can be used for sending a command message to a device which can be controlled over serial port. Both local RS-232 and extended link RS-232 ports can be used. The three different commands allow to use different message formats.

#### Sending Message

The command is for sending a command messages in ASCII-format with an option for escaping special characters.

#### Command and Response

- ▶ CALL•/MEDIA/UART/P1:sendMessage(<message>)
- ◀ mO•/MEDIA/UART/P1:sendMessage

#### Example

- ▶ CALL /MEDIA/UART/P1:sendMessage(PWR0\x0d\x0a)
- ◀ mO /MEDIA/UART/P1:sendMessage

#### Escaping in the Message

When commands need to be separated by <CR><LF> characters to be recognized by the controlled device, then they need to be escaped. You can use the following format for escaping:

*<command<sub>1</sub>><\x0d\x0a><command<sub>2</sub>><\x0d\x0a>...<command<sub>n</sub>><\x0d\x0a>*

See more details in [Escaping](#) section.

#### Sending Text Message

The command is for sending a text message in ASCII-format.

■ INFO: Escaping will not be processed using the **sendText** command.

#### Command and Response

- ▶ CALL•/MEDIA/UART/P1:sendText(<message>)
- ◀ mO•/MEDIA/UART/P1:sendText

#### Example

- ▶ CALL /MEDIA/UART/P1:sendText(pwr\_on)
- ◀ mO /MEDIA/UART/P1:sendText

#### Sending Binary Message

The command is for sending a binary message in HEX format.

#### Command and Response

- ▶ CALL•/MEDIA/UART/<P1>.sendBinaryMessage(<message>)
- ◀ mO•/MEDIA/UART/<P1>:sendBinaryMessage

#### Example

- ▶ CALL /MEDIA/UART/P1:sendBinaryMessage(1100000061620000cdcc2c40)
- ◀ mO /MEDIA/UART/P1:sendBinaryMessage

### 6.7.2. Sending Message via TCP Port

The device can be used for sending a message to a certain IP:port address. The three different commands allow controlling the connected (third-party) devices.

#### Sending TCP Message

The command is for sending a command messages in ASCII-format with an option for escaping special characters.

#### Command and Response

- ▶ CALL•/MEDIA/ETHERNET:tcpMessage(<IP\_address>:<port\_no>=<message>)
- ◀ mO•/MEDIA/ETHERNET:tcpMessage

#### Example

- ▶ CALL /MEDIA/ETHERNET:tcpMessage(192.168.0.20:5555=PWR0\x0d\x0a)
- ◀ mO /MEDIA/ETHERNET:tcpMessage

#### Escaping in the Message

When commands need to be separated by <CR><LF> characters to be recognized by the controlled device, then they need to be escaped. You can use the following format for escaping:

*<command<sub>1</sub>><\x0d\x0a><command<sub>2</sub>><\x0d\x0a>...<command<sub>n</sub>><\x0d\x0a>*

See more details in [Escaping](#) section.

### Sending Text Message

The command is for sending a text message in ASCII-format.

INFO: Escaping will not be processed using the **tcpText** command.

#### Command and Response

- ▶ CALL•/MEDIA/ETHERNET:tcpText(<IP\_address>:<port\_no>=<message>)
- ◀ mO•/MEDIA/ETHERNET:tcpText

#### Example

- ▶ CALL /MEDIA/ETHERNET:tcpText(192.168.0.20:5555=pwr\_on)
- ◀ mO /MEDIA/ETHERNET:tcpText

### Sending Binary Message

The command is for sending a binary message in HEX format.

#### Command and Response

- ▶ CALL•/MEDIA/ETHERNET:tcpBinary(<IP\_address>:<port\_no>=<message>)
- ◀ mO•/MEDIA/ETHERNET:tcpBinary

#### Example

- ▶ CALL /MEDIA/ETHERNET:tcpBinary(192.168.0.20:5555=0100000061620000cdcc2c40)
- ◀ mO /MEDIA/ETHERNET:tcpBinary

### 6.7.3. Sending Message via UDP Port

The device can be used for sending a message to a certain IP:port address. The three different commands allow controlling the connected (third-party) devices.

#### Sending UDP Message

The command is for sending a command messages in ASCII-format with an option for escaping special characters.

#### Command and Response

- ▶ CALL•/MEDIA/ETHERNET:udpMessage(<IP\_address>:<port\_no>=<message>)
- ◀ mO•/MEDIA/ETHERNET:udpMessage

#### Example

- ▶ CALL /MEDIA/ETHERNET:udpMessage(192.168.0.20:5555=PWR0\x0d\x0a)
- ◀ mO /MEDIA/ETHERNET:udpMessage

### Escaping in the Message

When commands need to be separated by <CR><LF> characters to be recognized by the controlled device, then they need to be escaped. You can use the following format for escaping:

*<command<sub>1</sub>>\x0d\x0a<command<sub>2</sub>>\x0d\x0a...<command<sub>n</sub>>\x0d\x0a*

See more details in [Escaping](#) section.

### Sending Text Message

The command is for sending a text message in ASCII-format.

INFO: Escaping will not be processed using the **udpText** command.

#### Command and Response

- ▶ CALL•/MEDIA/ETHERNET:udpText(<IP\_address>:<port\_no>=<message>)
- ◀ mO•/MEDIA/ETHERNET:udpText

#### Example

- ▶ CALL /MEDIA/ETHERNET:udpText(192.168.0.20:5555=pwr\_on)
- ◀ mO /MEDIA/ETHERNET:udpText

### Sending Binary Message

The command is for sending a binary message in HEX format.

#### Command and Response

- ▶ CALL•/MEDIA/ETHERNET:udpBinary(<IP\_address>:<port\_no>=<message>)
- ◀ mO•/MEDIA/ETHERNET:udpBinary

#### Example

- ▶ CALL /MEDIA/ETHERNET:udpBinary(192.168.0.20:5555=0100000061620000cdcc2c40)
- ◀ mO /MEDIA/ETHERNET:udpBinary

## 6.8. EDID Management

### 6.8.1. Querying the Emulated EDIDs

#### Command and Response

- ▶ GET•/EDID.EdidStatus
- ◀ pr•/EDID.EdidStatus=<source>:E1;<source>:E2

#### Parameters

Identifier	Parameter description	Parameter values
<source>	Source EDID memory place	F#: Factory (F1-148) U#: User (U1- U14) D#: Dynamic (D1-D2)

#### Example

- ▶ GET /EDID.EdidStatus
- ◀ pr /EDID.EdidStatus=D1:E1;D1:E2

Dynamic EDID was emulated for both input port.

### 6.8.2. Querying the Validity of a Dynamic EDID

#### Command and Response

- ▶ GET•/EDID/D/<dynamic\_edid>.Validity
- ◀ pr•/EDID/D/<dynamic\_port>.Validity=<validity>

#### Parameters

<dynamic_port>	Dynamic EDID memory place(D1 or D2)
<validity>	true or false

#### Example

- ▶ GET /EDID/D/D1.Validity
- ◀ pr EDID/D/D1.Validity=true

The 'Validity' property is true, valid EDID is stored in D1 memory place.

### 6.8.3. Querying the Preferred Resolution of an User EDID

#### Command and Response

- ▶ GET•/EDID/U/<user\_edid>.PreferredResolution
- ◀ pr•/EDID/U/<user\_edid>.PreferredResolution=<preferred\_resolution>

#### Parameters

<user_edid>	User EDID memory slot (U1-14)
<preferred_resolution>	[x]x[y][i i\p][f]

#### Example

- ▶ GET /EDID/U/U1.PreferredResolution
- ◀ pr /EDID/U/U1.PreferredResolution=3840x2160p60.00Hz

INFO: Use the "Manufacturer" property to query the manufacturer and the "MonitorName" property to query the name of the monitor.

### 6.8.4. Emulating an EDID to an Input Port

#### Command and Response

- ▶ CALL•/EDID:switch(<source>:<destination>)
- ◀ mO•/EDID:switch

#### Parameters

<source>: Source EDID memory place: Factory / User / Dynamic.  
<destination>: The emulated EDID memory of the desired input port.

#### Example

- ▶ CALL /EDID:switch(F144:E2)
- ◀ mO /EDID:switch

### 6.8.5. Copying an EDID to User Memory

#### Command and Response

**ATTENTION!** The (User) EDID memory slot will be overwritten without notification even if it was not empty.

#### Command and Response

- ▶ CALL•/EDID:copy(<source>:<destination>)
- ◀ mO•/EDID:copy

#### Parameters

Identifier	Parameter description	Parameter values
<source>	Source EDID memory place	F#: Factory (F1-148) U#: User (U1- U14) D#: Dynamic (D1-D2)
<destination>	The desired User EDID memory slot	U#: User (U1- U14)

Many copy operations can be performed at the same time by using semicolons (see **Example2**).

#### Example1:

- ▶ CALL /EDID:copy(D2:U2)
- ◀ mO /EDID:copy

#### Example2:

- ▶ CALL /EDID:copy(D1:U5;D1:U6)
- ◀ mO /EDID:copy

### 6.8.6. Deleting an EDID from User Memory

#### Command and Response

- ▶ CALL•/EDID:delete(<user\_edid\_memory>)
- ◀ mO•/EDID:delete

#### Parameters

<user\_edid> User EDID memory slot (U1-14)

#### Example

- ▶ CALL /EDID:delete(U1)
- ◀ mO /EDID:delete

### 6.8.7. Resetting the Emulated EDIDs

#### Command and Response

- ▶ CALL•/EDID:reset(1)
- ◀ mO•/EDID:reset

#### Example

- ▶ CALL /EDID:reset(1)
- ◀ mO /EDID:reset

Calling this method switches all emulated EDIDs to factory default one. See the table in the [Factory EDID List](#) section.



## 6.9. LW3 Commands - Quick Summary

### System Commands

#### Querying the Product Name

- ▶ GET•/.ProductName

#### Setting the Device Label

- ▶ SET•/MANAGEMENT/UID/DeviceLabel=<Custom\_name>

#### Querying the Serial Number

- ▶ GET•/.SerialNumber

#### Querying the Firmware Version

- ▶ GET•/SYS/MB.FirmwareVersion

#### Resetting the Extender

- ▶ CALL•/SYS:reset()

#### Restoring the Factory Default Settings

- ▶ CALL•/SYS:factoryDefaults()

#### Locking Front Panel

- ▶ SET•/MANAGEMENT/UI.ControlLock=<lock\_status>

#### Enabling Dark Mode

- ▶ SET•/MANAGEMENT/UI.DARKMODE.DarkModeEnable=<dark\_mode\_status>

#### Setting the Dark Mode Delay

- ▶ SET•/MANAGEMENT/UI.DARKMODE.DarkModeDelay=<delay\_sec>

#### Setting the Dark Mode on the Remote Device

- ▶ SET•/REMOTE/D1.DarkModeEnable=<dark\_mode\_status>

#### Setting the Rotary Direction of the Jog Dial Knob

- ▶ SET•/MANAGEMENT/UI.RotaryDirection=<direction>

### Video Port and Crosspoint Settings

#### Querying the Crosspoint Setting

- ▶ GET•/MEDIA/VIDEO/XP.DestinationConnectionList

#### Switching Video Input

- ▶ CALL•/MEDIA/VIDEO/XP:switch(<in>:<out>)

#### Muting Input Port

- ▶ CALL•/MEDIA/VIDEO/XP:muteSource(<in>)

#### Unmuting Input Port

- ▶ CALL•/MEDIA/VIDEO/XP:unmuteSource(<in>)

#### Locking Input Port

- ▶ CALL•/MEDIA/VIDEO/XP:lockSource(<in>)

#### Unlocking Input Port

- ▶ CALL•/MEDIA/VIDEO/XP:unlockSource(<in>)

#### HDCP Setting

- ▶ SET•/MEDIA/VIDEO/<in>.HdcpVersion=<hdcp\_version>

#### Querying the Status of Source Ports

- ▶ GET•/MEDIA/VIDEO/XP.SourcePortStatus

#### Querying the Status of Destination Ports

- ▶ GET•/MEDIA/VIDEO/XP.DestinationPortStatus

#### Querying the Video Autoselect Settings

- ▶ GET•/MEDIA/VIDEO/XP.DestinationPortAutoselect

#### Changing the Autoselect Mode

- ▶ CALL•/MEDIA/VIDEO/XP:setDestinationPortAutoselect(<out>:<out\_set>)

#### Setting the Output Conversion Mode

- ▶ SET•/MEDIA/VIDEO/O1.Conversion=<conversion\_mode>

#### Setting the Output Conversion Mode of the Remote Device

- ▶ SET•/REMOTE/D1.Conversion=<conversion\_mode>

**Network Configuration****Querying the IP Address**

- ▶ GET•/MANAGEMENT/NETWORK.IpAddress

**Changing the IP Address (Static)**

- ▶ SET•/MANAGEMENT/NETWORK.StaticIpAddress=<IP\_address>

**Querying the Subnet Mask**

- ▶ GET•/MANAGEMENT/NETWORK.NetworkMask

**Changing the Subnet Mask (Static)**

- ▶ SET•/MANAGEMENT/NETWORK.StaticNetworkMask=<netmask>

**Querying the Gateway Address**

- ▶ GET•/MANAGEMENT/NETWORK.GatewayAddress

**Changing the Gateway Address (Static)**

- ▶ SET•/MANAGEMENT/NETWORK.StaticGatewayAddress=<gw\_address>

**Querying the DHCP State**

- ▶ GET•/MANAGEMENT/NETWORK.DhcpEnabled

**Changing the DHCP State**

- ▶ SET•/MANAGEMENT/NETWORK.DhcpEnabled=<dhcp\_state>

**Enabling Ethernet Port**

- ▶ SET•/MEDIA/ETHERNET/<eth\_port>.Enabled=<status>

**RS-232 Port Configuration****Querying the RS-232 Operation Mode**

- ▶ GET•/MEDIA/UART/P1.Rs232Mode

**Setting the RS-232 Operation Mode**

- ▶ SET•/MEDIA/UART/P1.Rs232Mode=<rs232\_mode>

**Setting the BAUD Rate**

- ▶ SET•/MEDIA/UART/P1.Baudrate=<baudrate>

**Setting the Databit**

- ▶ SET•/MEDIA/UART/P1.DataBits=<databit>

**Setting the Stopbits**

- ▶ SET•/MEDIA/UART/P1.StopBits=<stopbit>

**Setting the Parity**

- ▶ SET•/MEDIA/UART/P1.Parity=<parity>

**Enabling Command Injection Mode**

- ▶ SET•/MEDIA/UART/P1.CommandInjectionEnable=<ci\_enable>

**Sending Message via the Communication Ports****Sending Message via an RS-232 Port**

- ▶ CALL•/MEDIA/UART/P1.sendMessage(<message>)
- ▶ CALL•/MEDIA/UART/P1.sendText(<message>)
- ▶ CALL•/MEDIA/UART/<P1>.sendBinaryMessage(<message>)

**Sending Message via TCP Port**

- ▶ CALL•/MEDIA/ETHERNET.tcpMessage(<IP\_address>:<port\_no>=<message>)
- ▶ CALL•/MEDIA/ETHERNET.tcpText(<IP\_address>:<port\_no>=<message>)
- ▶ CALL•/MEDIA/ETHERNET.tcpBinary(<IP\_address>:<port\_no>=<message>)

**Sending Message via UDP Port**

- ▶ CALL•/MEDIA/ETHERNET.udpMessage(<IP\_address>:<port\_no>=<message>)
- ▶ CALL•/MEDIA/ETHERNET.udpText(<IP\_address>:<port\_no>=<message>)
- ▶ CALL•/MEDIA/ETHERNET.udpBinary(<IP\_address>:<port\_no>=<message>)

**EDID Management****Querying the Emulated EDIDs**

- ▶ GET•/EDID.EdidStatus

**Querying the Validity of a Dynamic EDID**

- ▶ GET•/EDID/D/<dynamic\_edid>.Validity

**Querying the Preferred Resolution of an User EDID**

- ▶ GET•/EDID/U/<user\_edid>.PreferredResolution

**Emulating an EDID to an Input Port**

- ▶ CALL•/EDID:switch(<source>:<destination>)

**Copying an EDID to User Memory**

- ▶ CALL•/EDID:copy(<source>:<destination>)

**Deleting an EDID from User Memory**

- ▶ CALL•/EDID:delete(<user\_edid\_memory>)

**Resetting the Emulated EDIDs**

- ▶ CALL•/EDID:reset(1)

# 7

## Firmware Upgrade

This chapter is meant to help customers perform firmware upgrades on our products by giving a few tips on how to start and by explaining the features of the Lightware Device Updater2 (LDU2) software. To get the latest software and firmware pack can be downloaded from [www.lightware.com](http://www.lightware.com).

- ▶ [BACKWARD COMPATIBILITY](#)
- ▶ [ABOUT THE FIRMWARE PACKAGE \(LFP2 FILE\)](#)
- ▶ [INSTALLATION](#)
- ▶ [FIRMWARE UPGRADING STEPS](#)
- ▶ [KEEPING THE CONFIGURATION SETTINGS](#)

**WARNING!** Do not perform the firmware upgrade both the transmitter and the receiver in the same time if one of them is connected to the local network via an optical link, because connection lost during the firmware upgrade can cause problems in the upgrade process.

**ATTENTION!** While the firmware is being upgraded, the normal operation mode is suspended as the extender is switched to bootload mode. Signal processing is not performed. Do not interrupt the firmware upgrade. If any problem occurs, reboot the device and restart the process.

**ATTENTION!** The firmware upgrade process has an effect on the configuration and the settings of the device. For more details, please see the [Firmware Upgrading Steps](#) section before the upgrade.

### 7.1. Backward Compatibility

Up to 1.2.0 firmware version, the previous firmware packages are in **.lfp** format (LFP1 file), the upgrade can be done with Lightware Device Updater v1 (LDU1) software.

From 1.2.0 firmware version, the firmware package format is **.lfp2** (LFP2 file) the upgrade can be done with Lightware Device Updater v2 (LDU2) software.

### 7.2. About the Firmware Package (LFP2 File)

The firmware files are packed in an LFP2 package. You need only this file to do the upgrade on your device.

- This allows using the same LFP2 package for different devices.
- The package contains all the necessary components, binary, and other files; You do not have to get further files.
- There is a descriptor file in the package that contains each firmware with version number and a list showing the compatible devices. The descriptor is displayed after loading the LFP2 file in the LDU2.

### 7.3. Installation

#### Installation Modes

During the installation you will be prompted to select the type of the installation: normal and the snapshot install.

Normal install	Snapshot install
Available for Windows and macOS	Available for Windows
The installer can update only this instance	Cannot be updated
Only one updateable instance can exist for all users	More than one different versions can be installed for all users

**ATTENTION!** Using the Normal install as the default value is highly recommended.

#### Installation for Windows

Run the installer. If the User Account Control displays a pop-up message click **Yes**. During the installation you will be prompted to select the type of the installation:

### Installation for macOS

Mount the DMG file with double clicking on it and drag the LDU2 icon over the Applications icon to copy the program into the Applications folder. If you want to copy the LDU2 into another location just drag the icon over the desired folder.

INFO: The Windows and the Mac application has the same look and functionality.

## 7.4. Firmware Upgrading Steps

**Step 1.** Connect the computer to the same network as the extenders switchers are located. Run the LDU2 software. The discovered and known devices are being loaded.

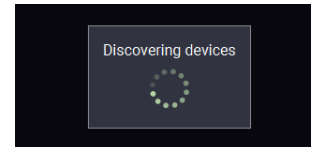

No firmware package selected (\*.lfp2) SELECT FIRMWARE PACKAGE PARAMETERS

1.	<input type="checkbox"/>	<b>UBEX-MMU-X200</b> UBEX-MMU-X200	IP: 192.168.3.245 S/N: 86122852	PACKAGE: v0.0.255b255 FW: v0.0.255b255	HW: V10_AAAX
2.	<input type="checkbox"/>	<b>UMX-HDMI-140-Plus</b> UMX-HDMI-140-Plus	IP: 192.168.3.120 S/N: 00006149	PACKAGE: v1.2.0b0 FW: v1.2.0b0	HW: V11_CAX0
3.	<input type="checkbox"/>	<b>HDMI20-OPTC-TX220-PRO</b> HDMI20-OPTC-TX220-PRO	IP: 192.168.0.111 S/N: 12345678	PACKAGE: v1.2.0b0 FW: v0.0.255b255	HW: V11_AAA0
4.	<input type="checkbox"/>	<b>UBEX-PRO20-HDMI-F110</b> UBEX-PRO20-HDMI-F100	IP: 192.168.2.135 S/N: 00005569	PACKAGE: v1.3.0b6 FW: v1.3.0b6	HW: V13_AAAX
5.	<input type="checkbox"/>	<b>UBEX-MMU-X200</b> UBEX-MMU-X200	IP: 192.168.2.200 S/N: 00005746	PACKAGE: v0.0.255b255 FW: v0.0.255b255	HW: V10_AAAX
6.	<input checked="" type="checkbox"/>	<b>HDMI20-OPTC-RX220-PRO</b> HDMI20-OPTC-RX220-PRO	IP: 192.168.0.112 S/N: 00006128	PACKAGE: v1.1.0b8 FW: v1.1.0b8	HW: V11_AAA0
7.	<input type="checkbox"/>	<b>UBEX-PRO20-HDMI-F110</b> UBEX-REMOTE	IP: 169.254.102.135 S/N: 87654321	PACKAGE: FW:	HW:

REFRESH SELECT ALL SELECT NONE START UPDATE

total:7 selected:1 discovered:7 success:0 failed:0 updating:0

### Legend of the Icons

Icon	Name	Description
	Device identifier	Clicking on the icon results the LDC screen blink for 10 seconds. The feature helps to identify the device itself in the rack shelf.
	IP address editor	To modify the IP address settings just click on the pencil icon.

**Step 2.** Select the firmware package file (\*.lfp2). When the file is selected the release note is displayed in the right window. Please read it carefully.

Path: D:\firmware\HDMI20-OPTC\HDMI20-OPTC\_v1.2.0 REFRESH Firmware package release note preview:

- DA2HDMI-4K-Plus-A
- DVI-OPT-TX220-PRO
- HDMI20-OPTC
  - HDMI20-OPTC\_v1.2.0b10.lfp2
  - HDMI20-OPTC\_v1.2.0b2.lfp2
  - HDMI20-OPTC\_v1.2.0b5.lfp2
  - HDMI20-OPTC\_v1.2.0b8.lfp2
- Matrix
- MMX6x2-HT220
- MMX8x4
- MODEX
- MX-CP\_V2\_no1
- mx2-hdmi20
- MX4X4DVI
- MX4X4DVI-DL
- MX8x8DVI-DL
- RAP
- SW\_DEVICECONTROLLER\_LWR
- TPS family
- UMX-HDMI-140

### Release notes for HDMI20-OPTC

**v1.2.0b10**

Release date: 2019-01-29

**New feature:**

- Added support for HDMI20-OPTC-TX220-FOX, HDMI20-OPTC-RX220-FOX, HDMI20-OPTC-TX220-NTQ and HDMI20-OPTC-RX220-NTQ product variants.
- From this version HDMI20-OPTC units can be upgraded by LDU2.

**v1.1.2b5**

Release date: 2018-06-20

**New feature:**

- We are introducing the support of I2C clock stretching on DDC lines.

**Bugfix:**

- We are introducing a new feature that provides compatibility with non-standard hot plug detect behaviour of sinks.
- Fixed a bug that caused multiple HPD toggling on boot.

**v1.1.1b1**

Release date: 2018-03-05

OPEN CANCEL

**Step 3.** Select the desired device(s). The available and supported devices are searched and listed automatically.

**Step 4.** Press the **Open** button. The listed devices – which are compatible with the firmware pack – are filtered automatically in the main screen.

**Step 5.** **Parameters** button opens a window, where the backup / restore function can be set. The location of the backup file can be changed by clicking on the **Choose folder** button. Put a tick beside **Restore device configuration** or **Factory default** option, depending on your needs. Restore the configuration is the default option.

### HDMI20-OPTC extender family - Update Parameters

**Backup folder:** Configuration backup file will be created in the given folder Choose folder  
C:/Users/judit.barsony/ldu2/backup

**Restore device configuration:** Restore device configuration from the backup file created at the beginning of the upgrade process.

**Skip device configuration presets at restore:** Skip device configuration presets at restoring device configuration.

**Factory default:** Reset device to factory settings when upgrade is done.

Advanced settings

**No configuration backup file:** If checked, no configuration backup file will be created.

APPLY CANCEL

**ATTENTION!** Settings in the parameters window related to all the upgraded devices.

**Step 6.** Click **Apply** to save the settings.

**Step 7.** Select the desired devices and press the **Start Update** button. The upgrade takes about 5 minutes to finish which is independent of the number of the upgraded devices since the upgrades are processed simultaneously.

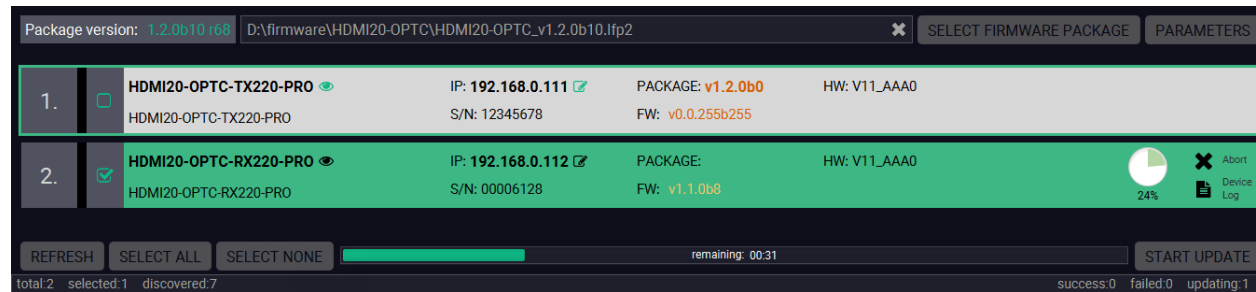

**Step 8.** After the part of LDU2 software upgrade process is finished, the extender starts the self-upgrade procedure. It is an automatic action and no any user interruption is needed during the operation.

**Step 9.** Finish. Clicking on the  icon, a log information is displayed in the Device Log window.

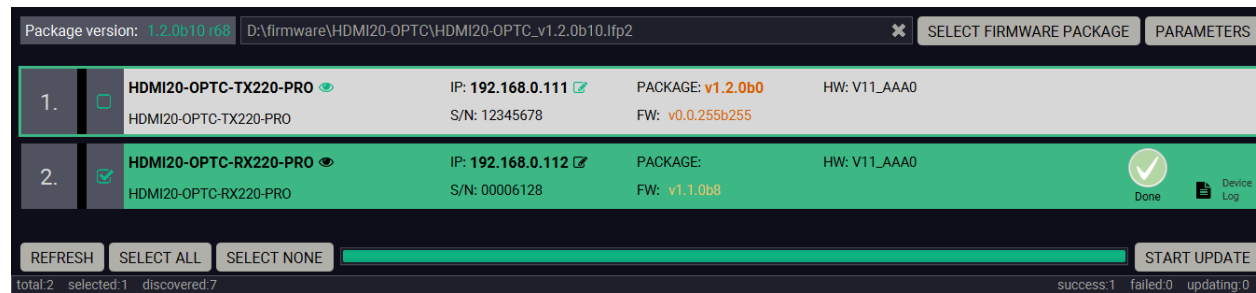

## 7.5. Keeping the Configuration Settings

By default, device configuration settings are restored when firmware upgrade is finished. If factory reset has been chosen in the parameters window, all device settings will be erased. LDC software contain the backup feature that allows saving the settings as a file and restore it later.

The following flow chart demonstrates how this function works in the background.

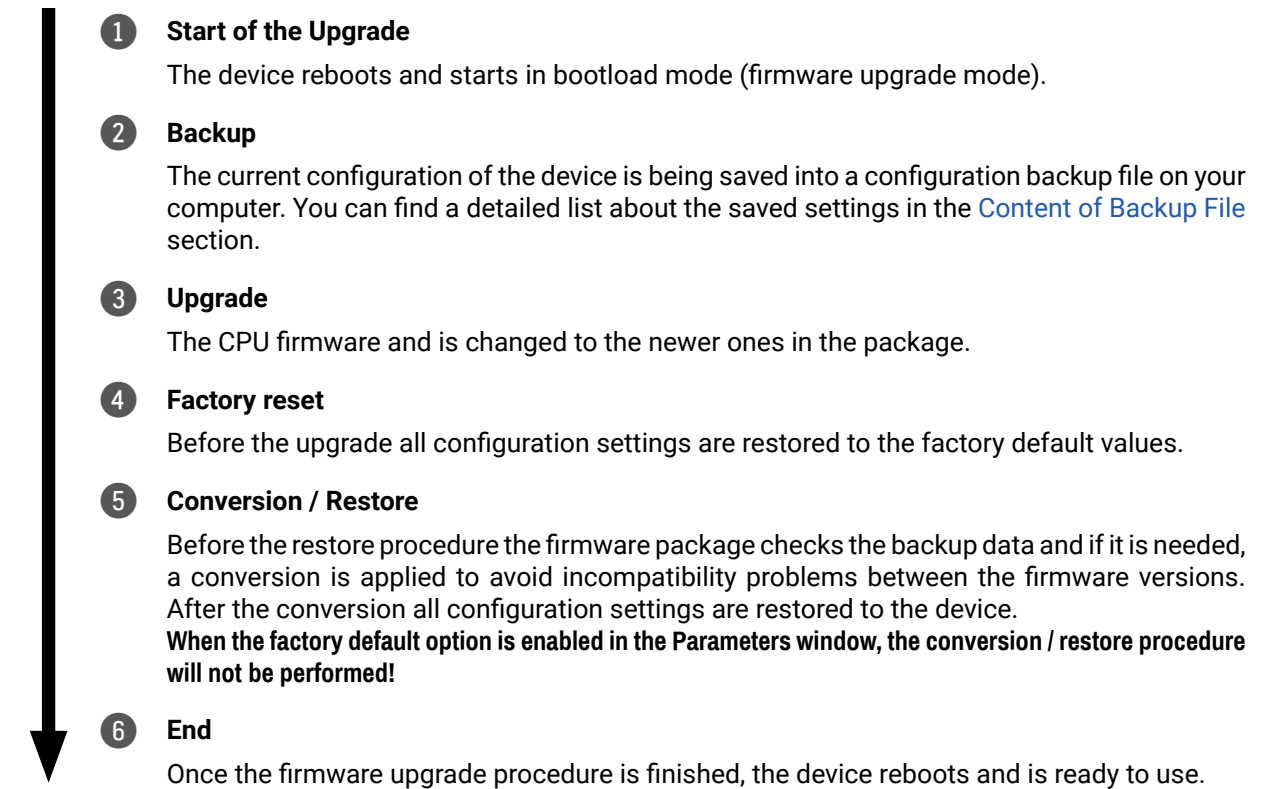





The details about the procedure: when firmware upgrade starts, the first step is making a backup of the settings of the device. The firmware package checks the backup data and if it is needed, a conversion is applied to avoid incompatibility problems between the firmware versions. If you do not want to keep configuration settings, you can set the Factory default option enabled.











# 8

















## Troubleshooting

Usually, if the system seems not to transport the signal as expected, the best strategy for troubleshooting is to check signal integrity through the whole signal chain starting from source side and moving forward to receiver end.

-  Link to connections/cabling section.
-  Link to front panel operation section.
-  Link to LDC software section.
-  Link to LW3 protocol commands section

At first, check front panel LEDs and take the necessary steps according to their states. For more information about status, LEDs refer to the [Front View](#) and [Rear View -Transmitters](#) sections.

Symptom	Root cause	Action	Refer to
<b>Video signal</b>			
<b>No picture on the video output</b>	Device(s) not powered properly.	Check the extenders and the other devices if they are properly powered; try to unplug and reconnect them.	 <a href="#">3.4</a>
	Cable connection problem.	Due to the high data rates cables must fit very well, check all the connectors. If your source or display has more connectors then make sure that the proper port is selected.	 <a href="#">3.4</a>
	Cable quality problem.	Due to the high data rates, high quality cables must be used. It is recommended to use OM3 or OM4 fiber cables.	 <a href="#">10.2</a>
	Endface surface of the fiber optical cable became contaminated.	Use special fiber optical cable cleaning equipment to clean it carefully.	
	Display is not capable of receiving the sent video format.	Try emulating your display device's EDID to the source.	 <a href="#">4.3.3</a>  <a href="#">5.6</a>  <a href="#">6.8.4</a>
	Source power and configuration problems.	Check whether your source is powered on and configured properly. The HDMI output can be turned off on most DVD players. If the source is a computer, then verify that the HDMI output is selected and active. Try restarting your computer; if you get a picture during the booting process, you have to review the driver settings.	
<b>HDMI output signal contains no audio</b>	Video signal type was set to DVI.	Check the signal type properties of the output port and set to HDMI or Auto.	 <a href="#">5.5.2</a>  <a href="#">5.5.4</a>
	DVI EDID is emulated.	Check the EDID and select and HDMI EDID to emulate.	 <a href="#">4.3.3</a>  <a href="#">5.6</a>  <a href="#">6.8.1</a>

Symptom	Root cause	Action	Refer to
<b>RS-232 signal</b>			
<b>Connected serial device cannot be controlled</b>	Cable connection problem	Check whether your serial cable is properly connected and check the wiring of the plugs.	 3.4
	RS-232 mode is not right	Check the RS-232 mode settings (pass, control and command injection)	 4.3.1  5.7.1  6.6.1
<b>Network</b>			
<b>No LAN connection can be established</b>	Incorrect IP address is set (fix IP)	Use dynamic IP address by enabling DHCP option.	 4.3.1  5.9.2  6.5.8
		Restore the factory default settings (with fix IP).	 4.3.1  5.7.1  6.3.6
	IP address conflict	Check the IP address of the other devices, too.	 5.3
<b>Miscellaneous</b>			
<b>No LEDs are light</b>	Dark mode is enabled	Disable the dark mode	 4.3.1  4.3.5  5.9.3  6.4.12
<b>Select/function button not toggles the inputs/ conversion modes</b>	Front panel buttons are locked	Unlock the buttons.	 5.9.3  6.3.7

### How to Speed up the Troubleshooting Process?

Lightware's technical support team is always working hard to provide the fastest support possible. Our team's response time is one of the best in the industry and in the toughest of cases we can directly consult with the hardware or software engineer who designed the product to get the information from the most reliable source.

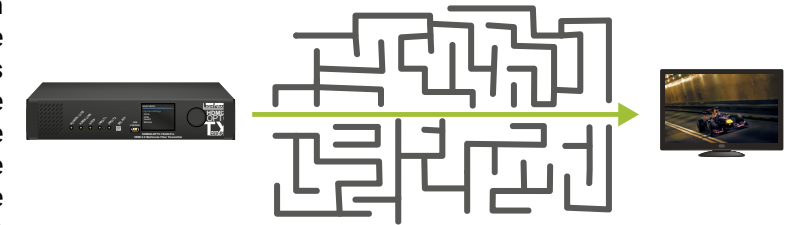

However, the troubleshooting process can be even faster... with your help.

There are certain pieces of information that push us in the right direction to finding the root cause of the problem. If we receive most of this information in the first e-mail or it is gathered at the time when you call us, then there is a pretty high chance that we will be able to respond with the final solution right away.

#### This information is the following:

- Schematic (a pdf version is preferred, but a hand drawing is sufficient).
- Serial number(s) of the device(s) (it is either printed somewhere on the box or you can query it in the Device Controller software or on the built-in website).
- Firmware versions of the devices (please note that there may be multiple CPUs or controllers in the device and we need to know all of their firmware versions, a screenshot is the best option).
- Cable lengths and types (in our experience, it's usually the cable).
- Patch panels, gender changers or anything else in the signal path that can affect the transmission.
- Signal type (resolution, refresh rate, color space, deep color).
- Emulated EDID(s) (please save them as file and send them to us).
- Actions to take in order to re-create the problem (if we cannot reproduce the problem, it is hard for us to find the cause).
- Photo or video about the problem ('image noise' can mean many different things, it's better if we see it too).
- Error logs and backup files from the Lightware Device Controller software.

The more of the above information you can give us the better. Please send these information to the Lightware [Support Team](#) to speed up the troubleshooting process.

# 9

## Technologies

The following sections contain descriptions and useful technical information how the devices work in the background. The content is based on experiences and cases we met in the practice. These sections help to understand features and technical standards like the followings:

- ▶ EDID MANAGEMENT
- ▶ HDCP MANAGEMENT
- ▶ PIXEL ACCURATE RECLOCKING
- ▶ SERIAL MANAGEMENT

### 9.1. EDID Management

#### 9.1.1. Understanding the EDID

The Extended Display Identification Data (EDID) is the passport of display devices (monitors, TV sets, projectors). It contains information about the capabilities of the display, such as supported resolutions, refresh rates (these are called Detailed Timings), the type and manufacturer of the display device, etc.

After connecting a source to a display (DVI, HDMI, DP), the source reads out the EDID to determine the resolution and refresh rate of the image to be transmitted.

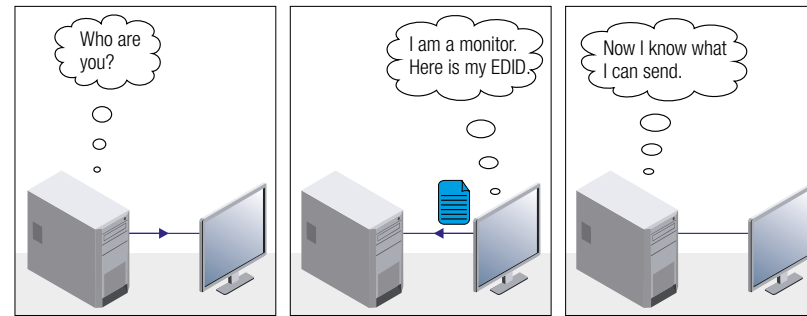

**EDID Communication**

Most DVI computer displays have 128-byte long EDID structure. However, Digital Televisions and HDMI capable displays may have another 128 bytes, which is called E-EDID and defined by CEA (Consumer Electronics Association). This extension contains information about additional Detailed Timings, audio capabilities, speaker allocation and HDMI capabilities. It is important to know that all HDMI capable devices must have CEA extension, but not all devices with CEA extension are HDMI capable.

#### Common Problems Related to EDID

**Problem:** “My system consists of the following: a computer, a Lightware device, a WUXGA (1920x1200) LCD monitor, and an SXGA (1280x1024) projector. I would like to see the same image on the monitor and the projector. What EDID should I choose on the Lightware device?”

**Solution:** If you want to see the image on both displays, you need to select the resolution of the smaller display (in this case SXGA), otherwise the smaller display may not show the higher resolution image.

**Problem:** “I have changed to a different EDID on an input port of the Lightware device to have a different resolution but nothing happens.”

**Solution:** Some graphics cards and video sources read out the EDID only after power-up and later they do not sense that EDID has been changed. You need to restart your source to make it read out the EDID again.

#### 9.1.2. Advanced EDID Management

Each DVI sink (e.g. monitors, projectors, plasma displays, etc...) must support the EDID data structure. Source BIOS and operating systems are likely to query the sink using DDC2B protocol to determine what pixel formats and interface are supported. DVI standard uses EDID data structure to identify the monitor type and capabilities. Most DVI sources (VGA cards, set top boxes, etc.) will output DVI signal after accepting the connected sink's EDID information. In the case of EDID readout failure or missing EDID, the source will not output DVI video signal.

Lightware devices provide the Advanced EDID Management function that helps system integration. The built-in EDID Router can store and emulate factory pre-programmed- and User programmable EDIDs. The EDID of the attached monitors or projectors for each output are stored in a non-volatile memory. This way the EDID of a monitor is available when the monitor is unplugged or switched off.

Any EDID can be emulated on any input. An emulated EDID can be copied from the EDID router's memory (static EDID emulation), or from the last attached monitor's memory (dynamic EDID emulation). For example, the Lightware device can be set up to emulate a sink device, which is connected to one of the outputs. In this case, the EDID automatically changes, if the monitor is replaced with another display device (as long as it has a valid EDID).

EDID is independently programmable for all inputs without affecting each other. All inputs have their own EDID circuit.

**INFO:** The user is not required to disconnect the video cable to change an EDID as opposed to other manufacturer's products. EDID can be changed even if a source is connected to the input and powered ON.

**INFO:** When EDID has been changed, the router toggles the HOTPLUG signal for 2 seconds. Some sources do not sense this signal. In such cases, the source device must be restarted or powered OFF and ON again.



## 9.2. HDCP Management

Lightware Visual Engineering is a legal HDCP adopter. Several functions have been developed which helps to solve HDCP related problems. Complex AV systems often have both HDCP and non-HDCP components. The extender allows transmitting HDCP encrypted and unencrypted signals. The devices will be still HDCP compliant as they will never output an encrypted signal to a non-HDCP compliant display device. If an encrypted signal is switched to a non-compliant output, a red screen alert or muted screen will appear.

### 9.2.1. Protected and Unprotected Content

Many video sources send HDCP protected signal if they detect that the sink is HDCP capable – even if the content is not copyrighted. This can cause trouble if an HDCP capable device is connected between the source and the display. In this case, the content cannot be viewed on non-HDCP capable displays and interfaces like event controllers. Rental and staging technicians often complain about certain laptops, which are always sending HDCP encrypted signals if the receiver device (display, extender router, etc.) reports HDCP compliancy. However, HDCP encryption is not required all the time e.g. computer desktop image, certain laptops still do that.

To avoid unnecessary HDCP encryption, Lightware introduced the HDCP enabling/disabling function: the HDCP capability can be disabled in the Lightware device. If HDCP is disabled, the connected source will detect that the sink is not HDCP capable, and turn off authentication.

### 9.2.2. Disable Unnecessary Encryption

#### HDCP Compliant Sink

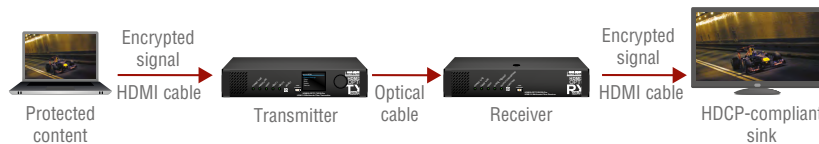

All the devices are HDCP-compliant, no manual setting is required, both protected and unprotected contents are transmitted and displayed on the sink.

#### Not HDCP-compliant Sink 1.

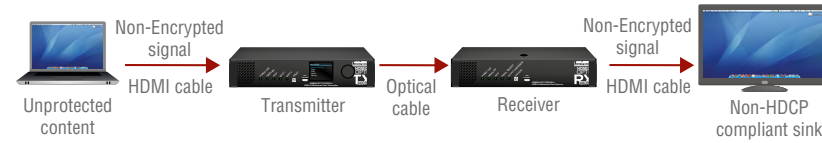

Non-HDCP compliant sink is connected to the extender. Some sources (e.g. computers) always send HDCP encrypted signals if the receiver device reports HDCP compliancy, however, HDCP encryption is not required all the time (e.g. computer desktop image). If HDCP is enabled in the extender, the image will not be displayed on the sink.

Setting the HDCP parameter to Auto on the output port and disable HDCP on the input port, the transmitted signal will not be encrypted if the content is not protected. Thus, non-HDCP compliant sinks will display non-encrypted signal.

#### Not HDCP-compliant Sink 2.

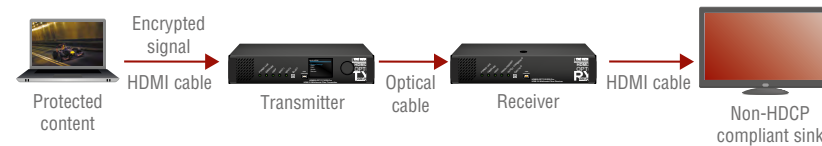

The layout is the same as in the previous case: non-HDCP compliant display device is connected to the extender but the source would send protected content with encryption. If HDCP is enabled on the input port of the extender, the source will send encrypted signal. The sink is not HDCP compliant, thus, it will not display the video signal (but blank/red/muted/etc. screen). If HDCP is disabled on the input port of the extender, the source will not send the signal. The solution is to replace the display device to an HDCP-capable one.

### 9.3. Pixel Accurate Reclocking

Signal reclocking is an essential important procedure in digital signal transmission. After passing the reclocking circuit, the signal becomes stable, jitter-free, and can be transmitted over more equipment like processors, or event controllers. Without reclocking, sparkles, noise, and jaggies appear on the image.

Lightware's sophisticated Pixel Accurate Reclocking technology fixes more problems than general TMDS reclocking. It removes not only intra-pair skew but inter-pair skew as well. The Pixel Accurate Reclocking circuit eliminates the following errors:

#### Intra-pair skew

Skew between the + and - wires within a differential wire pair (e.g. Data2- and Data2+). It's caused by different wire lengths or slightly different wire construction (impedance mismatch) in DVI cable. It results in jitter.

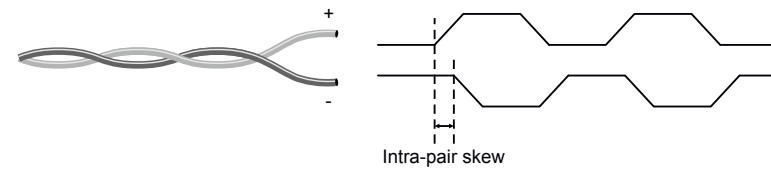

#### Inter-pair skew

Skew between two differential wire pairs in a cable. It is caused by different wire pair lengths or different number of twists in the DVI cable. Too much inter-pair skew results color shift in the picture or sync loss.

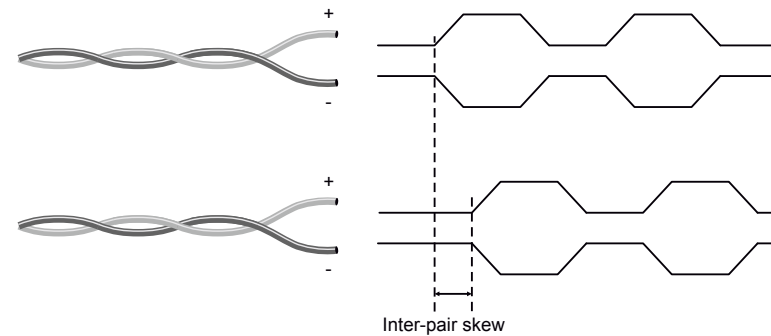

#### Jitter

Signal instability in the time domain. The time difference between two signal transitions should be a fixed value, but noise and other effects cause variations.

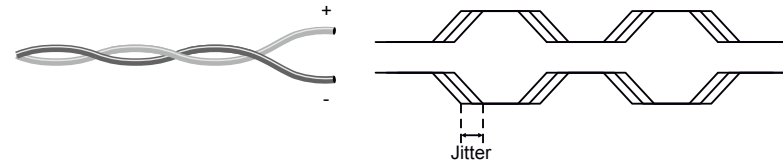

#### Noise

Electromagnetic interference between other electronic devices such as mobile phones, motors, etc. and the DVI cable are coupled onto the signal. Too much noise results in increased jitter.

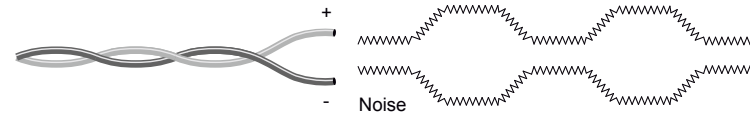

## 9.4. Serial Management

### 9.4.1. General Information

There are two types of devices in general serial communication:

- **Data Terminal Equipment:** Data Terminal Equipment (DTE) is an end instrument that converts user information into signals or reconverts received signals. Typical DTE devices: computers, LCD touch panels and control systems.
- **Data Circuit-terminating Equipment:** Data Circuit-terminating Equipment (DCE) is a device that sits between the DTE and a data transmission circuit. It is also called data communication equipment and data carrier equipment. Typical DCE devices: projectors, industrial monitors and amplifiers.

Among others the pin assignment is different between DTE and DCE.

	DTE	DCE
Pin 2:	RD	TD
Pin 3:	TD	RD

RD: Received Data (digital input)



TD: Transmitted Data (digital output)

Different type of serial cables must be used between different serial devices.

	DTE	DCE
DTE	Null-modem	Straight
DCE	Straight	Null-modem*

\* In general contact DCE with DCE by tail-circuit serial cable.

### 9.4.2. Types of Serial Cables

Straight Serial Cable	Null-modem Serial Cable
Straight pin-outs both ends.	Straight pin-out at the one end and cross pin-out at the other end (interchange lines of TX and RX).
	

Serial cables between devices may have male or female plugs and their type may be straight or null-modem in usual.

**ATTENTION!** The cable type does not depend on the plug type.

### 9.4.3. RS-232 Signal Transmission over Lightware Extender Devices

The following examples describe the detailed integration of Lightware devices between different RS-232 pin assignment units.

INFO: Both HDMI20-OPTC-TX220-PRO and HDMI20-OPTC-RX220-PRO are DTE units (according to their pinouts) with male plugs.

#### Extending RS-232 between DTE and DCE third-party devices

Connect null-modem serial cable between controller system (DTE) and the transmitter (DTE) and straight serial cable between receiver (DTE) and projector (DCE).

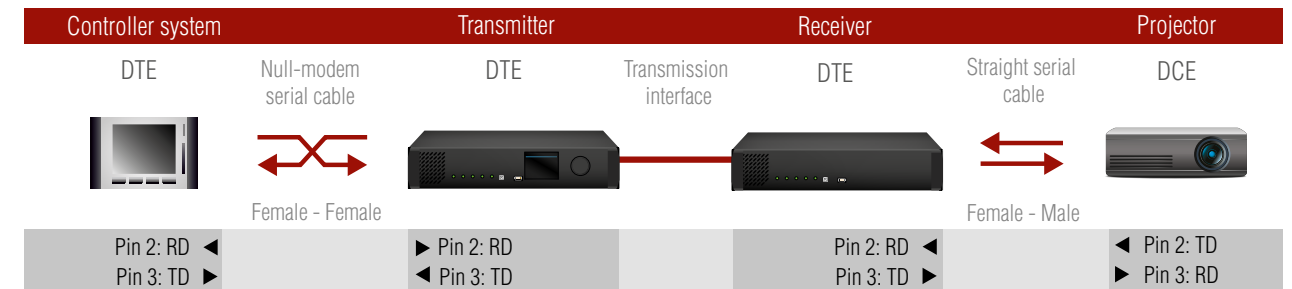

RS-232 connection example between a controller system and a projector

#### Extending RS-232 between DCE and DCE third-party devices

Connect straight serial cable between controller system (DTE) and the transmitter (DCE) and null-modem serial cable between receiver (DTE) and computer (DTE).

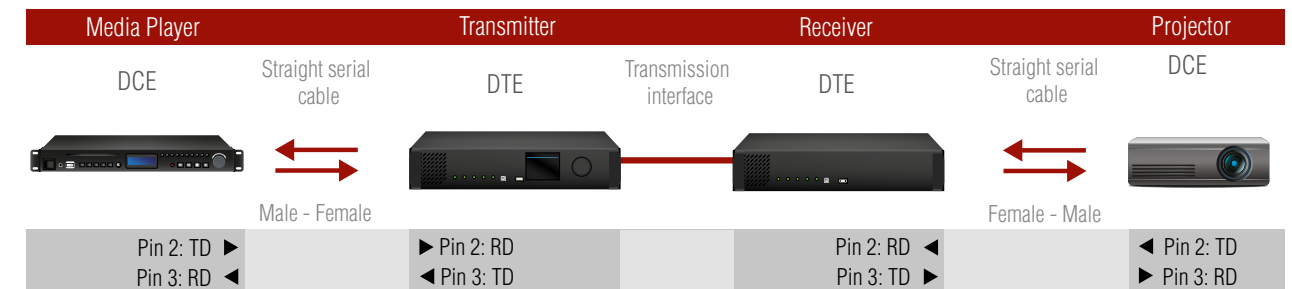

RS-232 connection example between a media player and a projector

# 10

## Appendix

- ▶ SPECIFICATION
- ▶ CONTENT OF BACKUP FILE
- ▶ FACTORY DEFAULT SETTINGS
- ▶ MAXIMUM EXTENSION DISTANCES
- ▶ FACTORY EDID LIST
- ▶ MECHANICAL DRAWINGS
- ▶ FURTHER INFORMATION

### 10.1. Specification

#### General

Compliance .....	CE
EMI/EMC compliance .....	EN 55035:2017 / EN 55032:2015
RoHS compliance .....	Yes
Safety.....	EN/IEC/UL/CSA 62368-1
Cooling.....	Cooling fan
Operating temperature .....	0 to +50°C (+32 to +122°F)
Storage temperature.....	-40 to +85°C (-40 to +185°F)
Operating humidity .....	10% to 80%, non-condensing
HDCP compliance.....	Yes
Warranty .....	3 years

#### Power

Power source .....	100-240V AC, 50/60Hz
Power connector (in HDMI20-OPTC-TX/RX220-PCN).....	Neutrik PowerCON TRUE 1 (NAC3MPX type)
Power connector (in the other models).....	IEC C14
Power consumption - typical TX / RX.....	7,1 W / 6,5 W
Power consumption -max TX / RX.....	11,6 W / 9,9 W

#### Enclosure

Rack mountable .....	Yes
Material.....	1 mm steel
Dimensions in mm (with device ears) .....	221W x 222,25D x 42,9H
Weight TX/RX.....	1480 g/1475 g

#### Optical Port

Optical connector (in HDMI20-OPTC-TX/RX220-PRO models) .....	Neutrik opticalCON DUO LC
Optical connector (in HDMI20-OPTC-TX/RX220-Fox models) .....	EBC-1502 type Fiberfox connector
Optical connector (in HDMI20-OPTC-TX/RX220-NTQ models) .....	.....
.....	Neutrik opticalCON QUAD connector (NO4FDW-A type)
Optical break-out connector.....	LC

Fiber.....	50/125 µm Multimode (OM3 or OM4 recommended)
Transmission distance.....	700 meters (using OM4 type fiber)
Laser class specification (RX).....	Class 1
Laser class specification (TX).....	Class 1M
Radiated wavelengths (TX).....	778 nm, 801 nm, 824 nm, 850 nm, 911 nm (IEC 60825-1:2014)
Total Power (TX).....	0.0367mW
Correction Factor Sum (TX).....	0.0253mW

**Video Ports**

Port connector type.....	19-pole HDMI type A receptacle
Supported video formats .....	DVI 1.0, HDMI 1.4, HDMI 2.0
Max. resolution .....	4096x2160@60Hz
.....	1920x1080@120Hz
Max. cable length on input (22 AWG).....	30 m
Color depth.....	Deep color support up to 36 bits,
Color space .....	RGB, YCbCr 4:4:4/4:2:0
Data rate TX (I1, I2, O1).....	18 Gbps
Data rate RX (O1A, O2) .....	18 Gbps
Data rate RX (O1B).....	9 Gbps
3D support.....	Yes
Audio formats .....	all formats in line with HDMI 2.0 standard
EDID emulation .....	Yes, Advanced EDID management
Reclocking.....	Pixel Accurate Reclocking

**Control Ports**

**LAN**

LAN connector .....	Neutrik etherCON (NE8FBH-S type)
Data rate .....	1 Gbit/s

**RS-232 Control**

Serial port connector .....	D-SUB connector
Available Baud rates .....	between 4800 and 115200

**USB Control**

USB connector .....	USB mini B-type
USB 2.0 compliance.....	Yes

**10.2. Maximum Extension Distances**

The below table shows the transmission distances via optical cable between the HDMI20-OPTC series depending on the cable quality and pixel clock frequency.

Resolution, Pixel clock rate	Cable lengths			
	OM1	OM2	OM3	OM4
1280x720p60 Hz	800m	1000m	2500m	2500m
1920x1080p60 Hz	500m	1000m	2500m	2500m
3840x2160p30 Hz (4k30 4:4:4)	200m	600m	1500m	1500m
3840x2160p60 Hz (4k60 4:2:0)				
3840x2160p60 Hz (4k60 4:4:4)	<b>Not supported</b>	300m	700m	700m
4096x2160p60 Hz (DCI 4K60)				

### 10.3. Content of Backup File

Transmitter	Receiver
<b>HDMI Input (I1, I2)</b>	
Port name	
Mute/ unmute input ports	
Lock/ unlock input ports	
Crosspoint settings	
<b>Optical Output (O1)</b>	<b>Optical Input (I1)</b>
Port name	Port name
Mute/ unmute output port	Mute/ unmute output port
Lock/ unlock output port	Lock/ unlock output port
Autoselect settings	
Signal type	Signal type
<b>HDMI Output (O2)</b>	<b>HDMI Output (O1,O2,O3)</b>
Port name	Port name
Mute/ unmute output port	Mute/ unmute output port
Lock/ unlock output port	Lock/ unlock output port
Autoselect settings	
Signal type	Signal type
+5V Enable	+5V Enable
<b>RS-232</b>	<b>RS-232</b>
Port name	Port name
RS-232 mode	RS-232 mode
Baud rate/ Data bits/ Stop bits/ Parity	Baud rate/ Data bits/ Stop bits/ Parity
Command injection enable/ Port	Command injection enable/ Port
Control protocol	Control protocol
<b>Ethernet</b>	<b>Ethernet</b>
Port name (P1, P2, P3, P4)	Port name (P1, P2, P3, P4)
Enable (P1, P2)	Enable (P1, P2)
<b>EDID Settings</b>	<b>EDID Settings</b>
User EDID U1-14	User EDID U1-13
Emulated EDIDs	Emulated EDIDs
<b>Event Manager</b>	<b>Event Manager</b>
Events 1-20	Events 1-20
<b>Front Panel Control</b>	<b>Front Panel Control</b>
Display brightness	
Rotary direction	
Control lock	
Dark mode enable	Dark mode enable

Transmitter	Receiver
Dark mode delay	Dark mode delay
Device label	Device label
<b>Network</b>	<b>Network</b>
DHCP enable	DHCP enable
Static IP address	Static IP address
Static network mask	Static network mask
Static gateway address	Static gateway address
<b>Remote device (Receiver)</b>	
Conversion mode	
O1 +5V Enable	
O2 +5V Enable	
O3 +5V Enable	

### 10.4. Factory Default Settings

#### Factory Default Settings of the Transmitter

Transmitter	
<b>Video settings: HDMI Input</b>	
Port number	I1, I2
Port name	HDMIIN1, HDMIIN2
Mute/ unmute input ports	Unmuted
Lock/ unlock input ports	Unlocked
Crosspoint settings	I1:O1; I1:O2
HDCP settings (I1 / I2)	Allow HDCP 1.4 or 2.2 / Allow HDCP 1.4
<b>Video settings: Optical Output</b>	
Port name	OPTOUT
Port number	O1
Mute/ unmute output port	Unmuted
Lock/ unlock output port	Unlocked
Autoselect settings	Disabled
Signal type	Auto
<b>Video settings: HDMI Output</b>	
Port name	HDMIOUT
Port number	O2
Mute/ unmute output port	Unmuted
Lock/ unlock output port	Unlocked
Autoselect settings	Disabled
Signal type	Auto
+5V Enable	Always on

Transmitter	
<b>Front panel settings</b>	
Display brightness	10
Rotary direction	CW
Control lock	Unlock
Dark mode enable, dark mode delay	Disable
<b>General</b>	
Device label	HDMI20-OPTC-TX220-PRO
<b>Network</b>	
DHCP enable	Disabled
Static IP address	192.168.0.101
Static network mask	255.255.255.0
Static gateway address	192.168.0.1
<b>Remote device (Receiver)</b>	
Conversion mode	No conversion
O1 +5V Enable (Output 1/A)	Always on
O2 +5V Enable (Output 1/B)	Always on
O3 +5V Enable (Output 2)	Always on

## Factory Default Settings of the Receiver

Receiver	
<b>Video settings: Optical Input</b>	
Port name	OPTIN
Port number	I1
Mute/ unmute input ports	Unmute
Lock/ unlock input ports	Unlock
<b>Video settings: HDMI Output</b>	
Port name	HDMIOUT1A, HDMIOUT1B, HDMIOUT2
Port number	O1, O2, O3
Mute/ unmute output port	Unmuted
Lock/ unlock output port	Unlocked
Signal type	Auto
+5V Enable	Always on
Conversion mode*	No conversion
HDCP mode	Depends on input
<b>Front panel</b>	
Control lock	Unlock
Dark mode enable, dark mode delay	Disable
<b>General</b>	
Device label	HDMI20-OPTC-RX220-PRO
<b>Network</b>	
DHCP enable	Disabled
Static IP address	192.168.0.102
Static network mask	255.255.255.0
Static gateway address	192.168.0.1

\* This setting is only available at HDMIOUT1A (O1) port.

## Factory Default Settings of the Transmitter and the Receiver

Transmitter	Receiver
<b>RS-232</b>	
Port name	Local
RS-232 mode	Pass-through
Baud rate	57600
Data bits	8
Stop bits	N
Parity	1
Command injection enable	Disabled
Port	8001
Control protocol	LW2
<b>Ethernet</b>	
Port name (P1, P2, P3, P4)	Ethernet, Ethernet, OPT, CPU
Enable (P1, P2)	Enable
<b>EDID Settings</b>	
Emulated EDIDs	D1* for all inputs
<b>Front panel</b>	
Display brightness	10
Rotary direction	CW
Control lock	Unlock
Dark mode enable, dark mode delay	Disable
<b>Remote device (Receiver)</b>	
Conversion mode	No conversion
O1 +5V Enable (Output 1/A)	Always on
O2 +5V Enable (Output 1/B)	Always on
O3 +5V Enable (Output 2)	Always on

\*The default emulated EDID is D1 both the transmitter and the receiver. The EDID, which is from the attached monitor of HDMIOUT1A (O1) port of the receiver, is copied to all the input ports.

## 10.5. Factory EDID List

Mem.	Resolution	Type
F1	640 x 480 @ 60.00 Hz	DVI
F2	848 x 480 @ 60.00 Hz	DVI
F3	800 x 600 @ 60.32 Hz	DVI
F4	1024 x 768 @ 60.00 Hz	DVI
F5	1280 x 768 @ 50.00 Hz	DVI
F6	1280 x 768 @ 59.94 Hz	DVI
F7	1360 x 768 @ 75.00 Hz	DVI
F8	1360 x 768 @ 60.02 Hz	DVI
F9	1280 x 1024 @ 50.00 Hz	DVI
F10	1280 x 1024 @ 60.02 Hz	DVI
F11	1280 x 1024 @ 75.02 Hz	DVI
F12	1400 x 1050 @ 50.00 Hz	DVI
F13	1400 x 1050 @ 60.00 Hz	DVI
F14	1400 x 1050 @ 75.00 Hz	DVI
F15	1680 x 1050 @ 60.00 Hz	DVI
F16	1920 x 1080 @ 50.00 Hz	DVI
F17	1920 x 1080 @ 60.00 Hz	DVI
F18	2048 x 1080 @ 50.00 Hz	DVI
F19	2048 x 1080 @ 60.00 Hz	DVI
F20	1600 x 1200 @ 50.00 Hz	DVI
F21	1600 x 1200 @ 60.00 Hz	DVI
F22	1920 x 1200 @ 50.00 Hz	DVI
F23	1920 x 1200 @ 59.56 Hz	DVI
F24	2048 x 1200 @ 59.96 Hz	DVI
F25-F28	Reserved	
F29	Universal DVI EDID	
F30	1440 x 480i @ 60.05 Hz	HDMI
F31	1440 x 576i @ 50.08 Hz	HDMI
F32	640 x 480 @ 59.95 Hz	HDMI
F33	720 x 480 @ 59.94 Hz	HDMI
F34	720 x 576 @ 50.00 Hz	HDMI
F35	1280 x 720 @ 50.00 Hz	HDMI
F36	1280 x 720 @ 60.00 Hz	HDMI
F37	1920 x 1080i @ 50.04 Hz	HDMI

Mem.	Resolution	Type
F38	1920 x 1080i @ 50.00 Hz	HDMI
F39	1920 x 1080i @ 60.05 Hz	HDMI
F40	1920 x 1080i @ 60.05 Hz	HDMI
F41	1920 x 1080 @ 24.00 Hz	HDMI
F42	1920 x 1080 @ 25.00 Hz	HDMI
F43	1920 x 1080 @ 30.00 Hz	HDMI
F44	1920 x 1080 @ 50.00 Hz	HDMI
F45	1920 x 1080 @ 60.00 Hz	HDMI
F46	1920 x 1080 @ 60.00 Hz	HDMI
F47	Universal HDMI EDID; PCM audio	
F48	Universal HDMI EDID; all audio	
F49	Universal HDMI EDID; all audio, deep color	
F50-F89	Reserved	
F90	1920 x 2160 @ 59.99 Hz	DVI
F91	1024 x 2400 @ 60.01 Hz	DVI
F92-F93	Reserved	
F94	2048 x 1536 @ 60.00 Hz	DVI
F95	Reserved	
F96	2560 x 1600 @ 59.86 Hz	DVI
F97	3840 x 2400 @ 24.00 Hz	DVI
F98	1280 x 720 @ 60.00 Hz	HDMI
F99	1920 x 1080 @ 60.00 Hz	HDMI
F100	1024 x 768 @ 60.00 Hz	HDMI
F101	1280 x 1024 @ 50.00 Hz	HDMI
F102	1280 x 1024 @ 60.02 Hz	HDMI
F103	1280 x 1024 @ 75.02 Hz	HDMI
F104	1600 x 1200 @ 50.00 Hz	HDMI
F105	1600 x 1200 @ 60.00 Hz	HDMI
F106	1920 x 1200 @ 59.56 Hz	HDMI
F107	2560 x 1440 @ 59.95 Hz	HDMI
F108	2560 x 1600 @ 59.86 Hz	HDMI
F109	3840 x 2400 @ 24.00 Hz	HDMI
F110	3840 x 2160 @ 24.00 Hz	HDMI
F111	3840 x 2160 @ 25.00 Hz	HDMI
F112	3840 x 2160 @ 30.00 Hz	HDMI

Mem.	Resolution	Type
F113-F117	Reserved	
F118	Universal HDMI EDID; 4K, PCM audio	
F119	Universal HDMI EDID; 4K, all audio	
F120	3840 x 2160 @ 60.00 Hz	HDMI
F121	1440 x 1080 @ 59.91 Hz	HDMI
F122	2560 x 2048 @ 59.98 Hz	HDMI
F123	1280 x 800 @ 59.91 Hz	HDMI
F124	1440 x 900 @ 59.90 Hz	HDMI
F125	1368 x 768 @ 59.85 Hz	HDMI
F126	1600 x 900 @ 59.98 Hz	HDMI
F127	2048 x 1080 @ 60.00 Hz	HDMI
F128	2560 x 1080 @ 60.00 Hz	HDMI
F129	3440 x 1440 @ 24.99 Hz	HDMI
F130	3440 x 1440 @ 29.99 Hz	HDMI
F131	4096 x 2160 @ 25.00 Hz	HDMI
F132	4096 x 2160 @ 30.00 Hz	HDMI
F133	4096 x 2160 @ 60.00 Hz	HDMI
F134	3440 x 1440 @ 23.99 Hz	HDMI
F135	4096 x 2160 @ 24.00 Hz	HDMI
F136	3840 x 2400 @ 29.99 Hz	HDMI
F137	3840 x 2160 @ 60.00 Hz	HDMI 2.0
F138	3840 x 2160 @ 50.00 Hz	HDMI 2.0
F139	Universal HDMI 2.0 EDID; UHD, PCM audio	
F140	Universal HDMI 2.0 EDID; UHD, all audio	
F141	4096 x 2160 @ 60.00 Hz	HDMI 2.0
F142	4096 x 2160 @ 50.00 Hz	HDMI 2.0
F143	Universal HDMI EDID; 4K, PCM audio	
F144	Universal HDMI EDID; 4K, all audio	
F145	Reserved	
F146	3840 x 2160 @ 60.00 Hz	HDMI 2.0
F147	3840 x 2160 @ 60.00 Hz	HDMI 2.0
F148	3840 x 2160 @ 60.00 Hz	HDMI 2.0



## 10.6. Mechanical Drawings

### 10.6.1. Transmitter

The following drawings present the physical dimensions of the transmitter. Dimensions are in mm.

INFO: All models have the same dimensions, the difference is only the connector types.

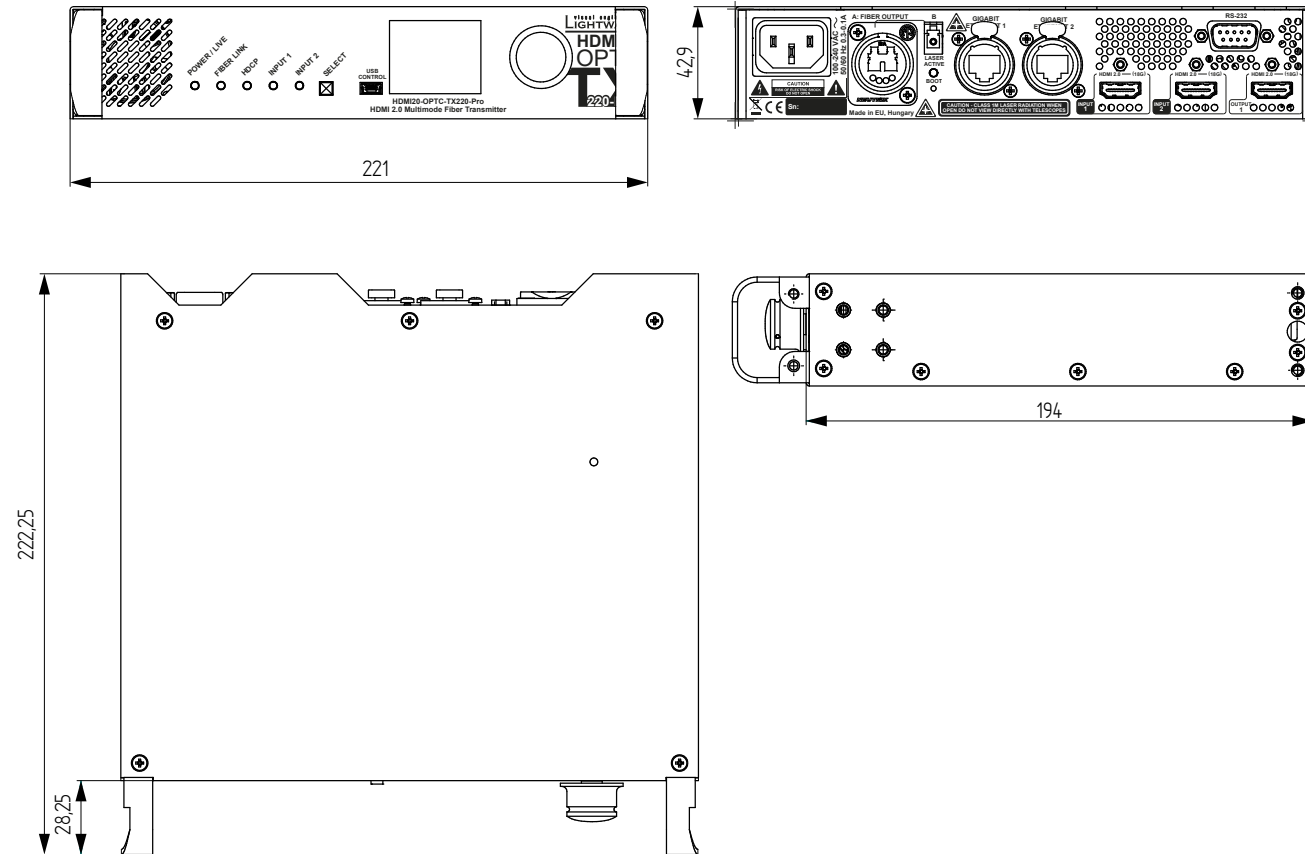

### 10.6.2. Receiver

The following drawings present the physical dimensions of the receiver. Dimensions are in mm.

INFO: All models have the same dimensions, the difference is only the connector types.

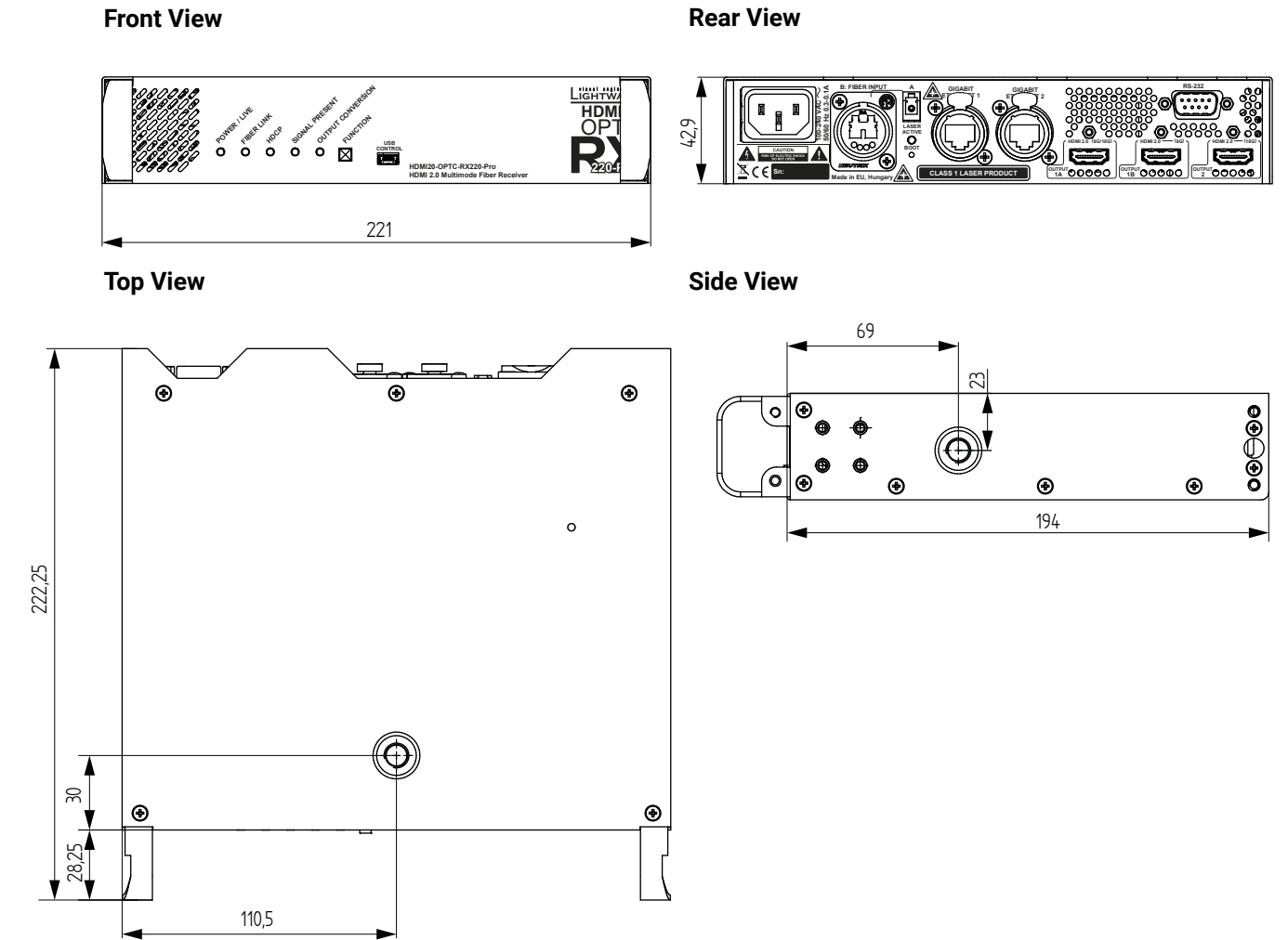

## 10.7. Further Information

### Limited Warranty Statement

1. Lightware Visual Engineering LLC (Lightware) warrants to all trade and end user customers that any Lightware product purchased will be free from manufacturing defects in both material and workmanship for three (3) years from purchase unless stated otherwise below. The warranty period will begin on the latest possible date where proof of purchase/delivery can be provided by the customer. In the event that no proof can be provided (empty 'Date of purchase' field or a copy of invoice), the warranty period will begin from the point of delivery from Lightware.

1.1. 25G and MODEX product series will be subject to a seven (7) year warranty period under the same terms as outlined in this document.

1.2. If during the first three (3) months of purchase, the customer is unhappy with any aspect of a Lightware product, Lightware will accept a return for full credit.

1.3. Any product that fails in the first six (6) months of the warranty period will automatically be eligible for replacement and advanced replacement where available. Any replacements provided will be warranted for the remainder of the original unit's warranty period.

1.4. Product failures from six (6) months to the end of the warranty period will either be repaired or replaced at the discretion of Lightware. If Lightware chooses to replace the product then the replacement will be warranted for the remainder of the original unit's warranty period.

2. The above-stated warranty and procedures will not apply to any product that has been:

2.1. Modified, repaired or altered by anyone other than a certified Lightware engineer unless expressly agreed beforehand.

2.2. Used in any application other than that for which it was intended.

2.3. Subjected to any mechanical or electrical abuse or accidental damage.

2.4. Any costs incurred for repair/replacement of goods that fall into the above categories (2.1., 2.2., 2.3.) will be borne by the customer at a pre-agreed figure.

3. All products to be returned to Lightware require a return material authorization number (RMA) prior to shipment and this number must be clearly marked on the box. If an RMA number is not obtained or is not clearly marked on the box, Lightware will refuse the shipment.

3.1. The customer will be responsible for in-bound and Lightware will be responsible for out-bound shipping costs.

3.2. Newly repaired or replaced products will be warranted to the end of the originally purchased products warranty period.

### Document Revision History

Rev.	Release date	Changes	Editor
1.0	08-11-2017	Initial version	Judit Barsony
1.1	28-02-2018	Correction of the appl. diagram and the description, add info to the conversion modes, HDCP related info	Judit Barsony
1.2	01-04-2019	Add HDMI20-OPTC-FOX, -NTQ, -PCN models info, LDU2 for firmware upgrade, 1080p120Hz signal support info added.	Judit Barsony
1.3	25-03-2020	Laser safety classification has been updated.	Laszlo Zsedenyi, Judit Barsony

### Contact Us

[sales@lightware.com](mailto:sales@lightware.com)

+36 1 255 3800

[support@lightware.com](mailto:support@lightware.com)

+36 1 255 3810

**Lightware Visual Engineering LLC.**  
Peterdy 15, Budapest H-1071, Hungary

[www.lightware.com](http://www.lightware.com)