

visual engineering  
**LIGHTWARE**

**User's Manual**

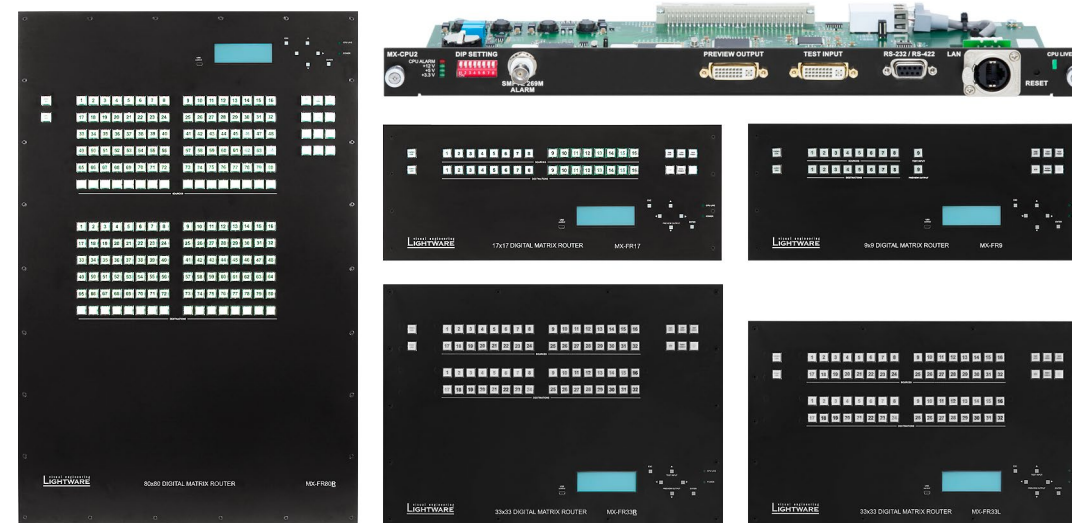

**MX-FR9, MX-FR9R, MX-FR17, MX-FR17R,  
MX-FR33L, MX-FR33R, MX-FR65R, MX-FR80R  
with MX-CPU2 and MX I/O Boards**

Hybrid Modular Multimedia Matrix

## Important Safety Instructions

### Class I apparatus construction.

This equipment must be used with a mains power system with a protective earth connection. The third (earth) pin is a safety feature, do not bypass or disable it. The equipment should be operated only from the power source indicated on the product.

To disconnect the equipment safely from power, remove the power cord from the rear of the equipment, or from the power source. The MAINS plug is used as the disconnect device, the disconnect device shall remain readily operable.

There are no user-serviceable parts inside of the unit. Removal of the cover will expose dangerous voltages. To avoid personal injury, do not remove the cover. Do not operate the unit without the cover installed.

The appliance must be safely connected to multimedia systems. Follow instructions described in this manual.

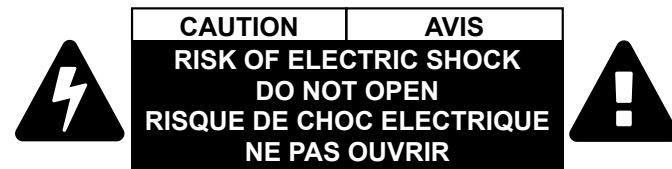

### Replacing the AC fuse

Unplug the AC power cord from the device. Locate the AC fuse on the rear panel. Replace only the AC fuse as indicated on the rear panel. Connect the power cord to the switcher and to the AC power source. Make sure the switcher is working properly.

### Ventilation

For the correct ventilation and to avoid overheating ensure enough free space around the appliance. Do not cover the appliance, let the ventilation holes free and never block or bypass the fans (if any).

### WARNING

To prevent injury, the apparatus is recommended to securely attach to the floor/wall or mount in accordance with the installation instructions. The apparatus shall not be exposed to dripping or splashing and that no objects filled with liquids, such as vases, shall be placed on the apparatus. No naked flame sources, such as lighted candles, should be placed on the apparatus.

## Waste Electrical & Electronic Equipment WEEE

This marking shown on the product or its literature, indicates that it should not be disposed with other household wastes at the end of its working life. To prevent possible harm to the environment or human health from uncontrolled waste disposal, please separate this from other types of wastes and recycle it responsibly to promote the sustainable reuse of material resources. Household users should contact either the retailer where they purchased this product, or their local government office, for details of where and how they can take this item for environmentally safe recycling. Business users should contact their supplier and check the terms and conditions of the purchase contract. This product should not be mixed with other commercial wastes for disposal.

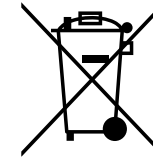

### Caution for Boards with Optical Module: Laser product



## Common Safety Symbols

Symbol	Description
	Direct current
	Alternating current
	Protective conductor terminal
	On (Power)
	Off (Power)
	Caution, possibility of electric shock
	Caution
	Laser radiation

## Symbol Legend

The following symbols and markings are used in the document:

**WARNING!** Safety-related information which is highly recommended to read and keep in every case!

**ATTENTION!** Useful information to perform a successful procedure; it is recommended to read.

**DIFFERENCE:** Feature or function that is available with a specific firmware/hardware version or product variant.

**INFO:** A notice which may contain additional information. Procedure can be successful without reading it.

**DEFINITION:** The short description of a feature or a function.

**TIPS AND TRICKS:** Ideas which you may have not known yet but can be useful.

## Navigation Buttons

 Go back to the previous page. If you clicked on a link previously, you can go back to the source page by pressing the button.

 Navigate to the Table of Contents.

 Step back one page.

 Step forward to the next page.

## Document Information

All presented functions refer to the indicated products. The descriptions have been made during testing these functions in accordance with the indicated Hardware/Firmware/Software environment:

Item	Version
Lightware Device Controller (LDC) software	1.33.2b1
Lightware Bootloader Software	3.3.2
CPU board / MX-CPU2 firmware	3.5.7b8
CPU board / Web content	1.7.2
CPU board / Web server	4.0.0
CPU board hardware	v2.2
Control Panel(s) firmware (MX-CP)	1.0.8
Motherboard	v2.3

Document revision: **3.2**

Release date: 25.02.2020

Editor: Laszlo Zsedenyi

## About Printing

Lightware Visual Engineering supports green technologies and Eco-friendly mentality. Thus, this document is made for digital usage primarily. If you need to print out few pages for any reason, follow the recommended printing settings:

- Page size: A4
- Output size: Fit to page or Match page size
- Orientation: Landscape

**TIPS AND TRICKS:** Thanks to the size of the original page, a border around the content (gray on the second picture below) makes possible to organize the pages better. After punching the printed pages, they can be placed easily into a ring folder.

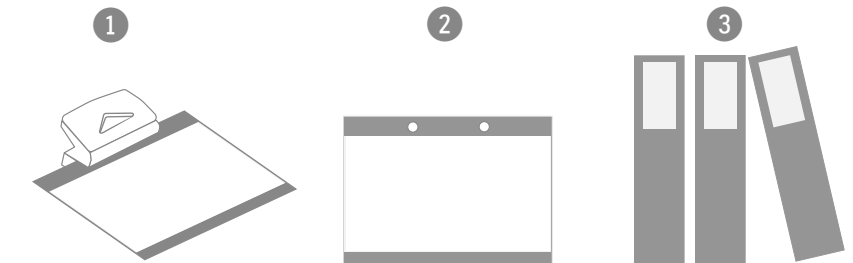

## Table of Contents

<b>1. INTRODUCTION</b> .....	<b>6</b>	4.4.3. Source and Destination Buttons .....	34	6.5.2. Diagnostic Tools .....	62
<b>1.1. DESCRIPTION</b> .....	<b>6</b>	4.4.4. Viewing Crosspoint State .....	34	6.5.3. Input Port Properties .....	63
<b>1.2. BOX CONTENTS</b> .....	<b>6</b>	4.4.5. Switching .....	35	6.5.4. Output Port Properties .....	71
<b>1.3. FEATURES OF THE DEVICE</b> .....	<b>7</b>	4.4.6. Switching Operations Flowchart .....	36	6.5.5. Presets .....	76
<b>1.4. TYPICAL APPLICATIONS</b> .....	<b>8</b>	4.4.7. Preset Operations .....	36	<b>6.6. EDID MENU</b> .....	<b>77</b>
<b>2. INSTALLATION</b> .....	<b>9</b>	4.4.8. Output Lock .....	37	6.6.1. Sources and Destinations .....	77
<b>2.1. MOUNTING OPTIONS</b> .....	<b>9</b>	<b>4.5. THE EDID MEMORY OF A MATRIX</b> .....	<b>38</b>	6.6.2. EDID Operations .....	78
<b>2.2. CONNECTING STEPS</b> .....	<b>9</b>	4.5.1. EDID Types .....	38	6.6.3. EDID Summary Window .....	78
<b>2.3. BOARD INSTALLATION AND HANDLING</b> .....	<b>10</b>	<b>4.6. AUDIO OPTIONS</b> .....	<b>38</b>	6.6.4. Editing an EDID .....	79
<b>2.4. PSU INSTALLATION AND HANDLING</b> .....	<b>11</b>	4.6.1. Legend of the Figures .....	38	6.6.5. Creating an EDID .....	79
<b>3. PRODUCT OVERVIEW</b> .....	<b>12</b>	4.6.2. Audio Settings .....	39	<b>6.7. SETTINGS MENU</b> .....	<b>80</b>
<b>3.1. HYBRID MODULAR MATRIX CONCEPT</b> .....	<b>12</b>	<b>4.7. TPS LINK MODES</b> .....	<b>40</b>	6.7.1. Configuration Tab .....	80
<b>3.2. ROUTER FRAMES</b> .....	<b>12</b>	<b>4.8. ABOUT THE ETHERNET (TPS AND TPS2 BOARDS)</b> .....	<b>41</b>	6.7.2. Device Information .....	81
<b>3.3. I/O BOARD CONFIGURATIONS</b> .....	<b>12</b>	4.8.1. Enable and Disable the Ethernet .....	41	6.7.3. Status .....	81
<b>3.4. MX-CPU2 PROCESSOR BOARD</b> .....	<b>12</b>	4.8.2. Avoid Causing an Ethernet Loop .....	41	6.7.4. Log .....	82
3.4.1. MX-CPU2 Board Features .....	13	<b>4.9. LCD CONTROL PANEL OPERATION</b> .....	<b>42</b>	6.7.5. User Preferences .....	83
<b>3.5. INPUT BOARDS</b> .....	<b>13</b>	4.9.1. Basic Concept .....	42	<b>6.8. TERMINAL WINDOW</b> .....	<b>83</b>
<b>3.6. OUTPUT BOARDS</b> .....	<b>14</b>	4.9.2. Normal Mode .....	42	<b>7. PROGRAMMER'S REFERENCE</b> .....	<b>84</b>
<b>3.7. MX-FR80R AND MX-FR65R</b> .....	<b>15</b>	4.9.3. LCD Menu Pop-up Messages .....	50	<b>7.1. PROTOCOL DESCRIPTION</b> .....	<b>84</b>
<b>3.8. MX-FR33R</b> .....	<b>17</b>	4.9.4. EDID Mode .....	51	7.1.1. Legend for Control Commands .....	84
<b>3.9. MX-FR33L</b> .....	<b>19</b>	4.9.5. Signal Present Mode .....	51	7.1.2. Renewed Protocol .....	84
<b>3.10. MX-FR17</b> .....	<b>21</b>	<b>4.10. REMOTE OPERATION</b> .....	<b>52</b>	7.1.3. Changing Protocols .....	84
<b>3.11. MX-FR17R</b> .....	<b>22</b>	4.10.1. Control Interfaces .....	52	<b>7.2. STORAGE MEMORIES</b> .....	<b>85</b>
<b>3.12. MX-FR9</b> .....	<b>23</b>	4.10.2. Multiple Simultaneous Connections .....	52	7.2.1. Matrix Frame Memory .....	85
<b>3.13. MX-FR9R</b> .....	<b>24</b>	4.10.3. IP Settings .....	52	7.2.2. CPU Board Memory .....	85
<b>3.14. ELECTRICAL CONNECTIONS</b> .....	<b>25</b>	4.10.4. Serial Port Settings .....	52	7.2.3. SD Memory Card (CPU2 Board) .....	85
3.14.1. Power Connections .....	25	4.10.5. Control Protocols .....	53	7.2.4. Input and Output Board Memory .....	85
3.14.2. Video Inputs and Outputs .....	25	<b>4.11. ERROR HANDLING</b> .....	<b>53</b>	<b>7.3. SWITCHING AND CONTROL COMMANDS</b> .....	<b>85</b>
3.14.3. Audio Inputs and Outputs .....	25	<b>5. SOFTWARE CONTROL - THE BUILT-IN WEB</b> .....	<b>54</b>	7.3.1. Test Input and Preview Output .....	85
3.14.4. RJ45 Connectors and Twisted Pair Cables .....	26	<b>5.1. SYSTEM REQUIREMENTS</b> .....	<b>54</b>	7.3.2. Selecting the 80th Input Port (MX-FR80R) .....	85
3.14.5. Further Connectors .....	27	<b>5.2. ESTABLISHING THE CONNECTION</b> .....	<b>54</b>	7.3.3. Switching an Input to an Output .....	86
<b>3.15. INPUT BOARDS</b> .....	<b>28</b>	<b>5.3. THE LAYOUT OF THE BUILT-IN WEB</b> .....	<b>54</b>	7.3.4. Switching an Input to All Outputs .....	86
<b>3.16. OUTPUT BOARDS</b> .....	<b>30</b>	<b>6. SOFTWARE CONTROL – LIGHTWARE DEVICE CONTROLLER SOFTWARE</b> .....	<b>55</b>	7.3.5. Diagonal Switching .....	86
<b>4. OPERATION</b> .....	<b>32</b>	<b>6.1. INSTALL AND UPGRADE</b> .....	<b>55</b>	7.3.6. Batch Switch Outputs .....	86
<b>4.1. POWERING ON</b> .....	<b>32</b>	<b>6.2. RUNNING THE LDC</b> .....	<b>55</b>	7.3.7. Displaying the Current Connection States of the Outputs .....	87
4.1.1. Redundant Power Supplies .....	32	<b>6.3. CONNECTING TO A DEVICE (DEVICE DISCOVERY WINDOW)</b> .....	<b>56</b>	7.3.8. Listing the Mute/Unmute States of All Outputs .....	87
<b>4.2. THE REMOTE POWER FEATURE OF MX-TPS BOARDS</b> .....	<b>33</b>	<b>6.4. CROSSPOINT MENU</b> .....	<b>57</b>	7.3.9. Muting a Specified Output .....	88
<b>4.3. THE REMOTE POWER FEATURE OF MX-TPS2 BOARDS</b> .....	<b>33</b>	6.4.1. Grid View .....	57	7.3.10. Unmuting a Specified Output .....	88
<b>4.4. BASIC CONTROL PANEL OPERATIONS</b> .....	<b>34</b>	6.4.2. Tile View .....	59	7.3.11. Disconnecting an Output .....	88
4.4.1. CONTROL LOCK .....	34	<b>6.5. PORT PROPERTIES AND SETTINGS</b> .....	<b>61</b>	7.3.12. Disconnect All Outputs .....	88
4.4.2. Take / Autotake Modes .....	34	6.5.1. Common Features .....	61	7.3.13. Locking a Specified Output .....	88



7.3.16. Loading a Preset .....	89	7.7.6. Querying the Header of an EDID .....	100	<b>9. TROUBLESHOOTING .....</b>	<b>137</b>
7.3.17. Preset Preview .....	89	7.7.7. Deleting an EDID From the Memory .....	100	<b>9.1. HOW TO SPEED UP THE TROUBLESHOOTING PROCESS .....</b>	<b>138</b>
7.3.18. Renaming a Preset .....	89	7.7.8. Downloading the Content of an EDID .....	101	<b>10. TECHNOLOGIES .....</b>	<b>139</b>
7.3.19. Renaming an Input .....	89	7.7.9. Uploading the EDID Content .....	101	<b>10.1. EDID MANAGEMENT .....</b>	<b>139</b>
7.3.20. Renaming an Output .....	89	<b>7.8. PORT STATUS COMMANDS .....</b>	<b>102</b>	10.1.1. Understanding the EDID .....	139
7.3.21. Querying the Name of a Preset .....	89	7.8.1. Input Port Status .....	102	10.1.2. Advanced EDID Management .....	139
7.3.22. Querying the Name of an Input .....	90	7.8.2. Output Port Status .....	103	<b>10.2. HDCP MANAGEMENT .....</b>	<b>140</b>
7.3.23. Querying the Name of an Output .....	90	7.8.3. All Port Status .....	103	10.2.1. Protected and Unprotected Content .....	140
7.3.24. Reloading the Default Preset Names .....	90	<b>7.9. I/O PORT COMMANDS .....</b>	<b>104</b>	10.2.2. Disable Unnecessary Encryption .....	140
7.3.25. Reloading the Default Input Names .....	90	7.9.1. TPS and TPS2 Port .....	104	<b>10.3. PIXEL ACCURATE RECLOCKING .....</b>	<b>140</b>
7.3.26. Reloading the Default Output Names .....	90	7.9.2. HDMI Input Port .....	105	<b>10.4. DUAL-LINK DVI SIGNAL .....</b>	<b>141</b>
<b>7.4. COMMUNICATION SETUP COMMANDS .....</b>	<b>91</b>	7.9.3. HDMI-3D Input Port .....	108	<b>10.5. RS-232 COMMAND TRANSMISSION .....</b>	<b>142</b>
7.4.1. Querying the IP Settings .....	91	7.9.4. HDMI Output Port .....	111	<b>10.6. THE RICOD TECHNOLOGY .....</b>	<b>143</b>
7.4.2. Reloading the Default IP Settings .....	91	7.9.5. HDMI-3D Output Port .....	114	10.6.1. Introduction .....	143
7.4.3. Setting a Dynamic IP Address (DHCP) .....	91	7.9.6. DVI-I Input Port .....	118	10.6.2. Operation .....	143
7.4.4. Querying the RS-232 Baud Rate .....	92	7.9.7. UMX Input Port .....	120	10.6.3. Enable / Disable RICOD .....	143
7.4.5. Changing the RS-232 Baud Rate .....	92	7.9.8. Analog Audio I/O Port .....	121	10.6.4. Validity of RICOD .....	143
7.4.6. Querying the Control Protocol .....	92	7.9.9. DVI-DL Output Port .....	122	10.6.5. Locking the Remote Device .....	143
7.4.7. Changing the Control Protocol .....	92	7.9.10. DVI-OPT Output Port .....	123	10.6.6. RICOD-Capable Devices .....	144
7.4.8. Configure Remote Alerts .....	93	<b>7.10. RICOD RELATED COMMANDS .....</b>	<b>123</b>	<b>11. APPENDIX .....</b>	<b>145</b>
<b>7.5. ROUTER STATUS COMMANDS .....</b>	<b>93</b>	7.10.1. Setting the RICOD MASTER Command .....	123	<b>11.1. SPECIFICATIONS .....</b>	<b>145</b>
7.5.1. Querying the Product Type .....	93	7.10.2. Querying the Set RICOD MASTER .....	124	11.1.1. General .....	145
7.5.2. Querying the Serial Number .....	93	7.10.3. Querying the RICOD SLAVE Status .....	124	11.1.2. Matrix Frames .....	145
7.5.3. Querying the Firmware Version of the CPU .....	93	7.10.4. Setting the RICOD SLAVE Status .....	124	11.1.3. I/O ports .....	145
7.5.4. Querying the CPU Firmware Compile Time .....	94	<b>7.11. RS-232 OVER FIBER COMMANDS .....</b>	<b>125</b>	<b>11.2. FACTORY DEFAULT SETTINGS .....</b>	<b>146</b>
7.5.5. Querying the Crosspoint Size .....	94	7.11.1. Sending Data in Text Format .....	125	<b>11.3. MAXIMUM CABLE LENGTHS (TPS AND TPS2 BOARDS) .....</b>	<b>146</b>
7.5.6. Querying the Number of the Allowed I/O Slots .....	94	7.11.2. Sending Data in Binary Format .....	125	<b>11.4. MAXIMUM CABLE LENGTHS (TP BOARDS) .....</b>	<b>146</b>
7.5.7. Querying the Installed I/O Boards .....	94	7.11.3. Querying the Serial Parameters .....	126	<b>11.5. FACTORY EDID LIST .....</b>	<b>147</b>
7.5.8. Querying the Firmware of All Controllers' .....	95	7.11.4. Setting the Serial Parameters .....	126	<b>11.6. CABLE WIRING GUIDE .....</b>	<b>148</b>
7.5.9. Querying the LAN Versions .....	95	<b>7.12. RS-232 OVER TPS COMMANDS .....</b>	<b>127</b>	<b>11.7. FIRMWARE RELEASE NOTES .....</b>	<b>149</b>
7.5.10. Querying the Health Status .....	95	7.12.1. Sending Data in Text Format .....	127	<b>11.8. MECHANICAL DRAWINGS .....</b>	<b>157</b>
7.5.11. Querying the Error List .....	95	7.12.2. Sending Data in Binary Format .....	127	11.8.1. MX-FR80R and MX-FR65R .....	157
<b>7.6. SYSTEM COMMANDS .....</b>	<b>96</b>	7.12.3. Querying the Serial Parameters .....	128	11.8.2. MX-FR33R .....	158
7.6.1. Restarting the Matrix .....	96	7.12.4. Setting the Serial Parameters .....	128	11.8.3. MX-FR33L .....	158
7.6.2. Querying the CPU Time .....	96	<b>7.13. ROUTER INITIATED COMMANDS .....</b>	<b>129</b>	11.8.4. MX-FR17 and FR17R, MX-FR9 and FR9R .....	159
7.6.3. Setting the CPU Time .....	97	7.13.1. EDID Status Changed .....	129	<b>11.9. ASCII TABLE .....</b>	<b>159</b>
7.6.4. Switching the Matrix to Standby .....	97	7.13.2. Port Status Changed (PSC) .....	129	<b>11.10. HASHTAG KEYWORD LIST .....</b>	<b>160</b>
7.6.5. Reloading the Factory Default Values and Settings .....	97	7.13.3. Error Responses .....	129	<b>11.11. FURTHER INFORMATION .....</b>	<b>161</b>
<b>7.7. EDID ROUTER COMMANDS .....</b>	<b>98</b>	<b>7.14. COMMANDS – QUICK SUMMARY .....</b>	<b>130</b>		
7.7.1. Changing the EDID on an Input Port .....	98	<b>8. FIRMWARE UPGRADE .....</b>	<b>133</b>		
7.7.2. Changing the EDID on All Inputs .....	99	<b>8.1. DETAILED INSTRUCTIONS OF THE UPGRADE .....</b>	<b>133</b>		
7.7.3. Saving an EDID to the User Memory .....	99	<b>8.2. FORCED FIRMWARE UPGRADE .....</b>	<b>135</b>		
7.7.4. Querying the EDID Validity Table .....	99	<b>8.3. FIRMWARE UPGRADE OF TPS(2) PORTS .....</b>	<b>136</b>		
7.7.5. Querying the Emulated EDIDs on All Inputs .....	100				

# 1

## Introduction

Thank You for choosing Lightware's MX-FR Hybrid Modular Matrix Switcher. In the first chapter we would like to introduce the device highlighting the most important features in the below listed sections:

- ▶ DESCRIPTION
- ▶ BOX CONTENTS
- ▶ FEATURES OF THE DEVICE
- ▶ TYPICAL APPLICATIONS

### 1.1. Description

Thank you for choosing Lightware matrix routers. The hybrid modular matrix routers are capable of routing DVI or HDMI signals in a scalable non-blocking crosspoint configuration, with up to 80 inputs and 80 outputs.

These products are designed according to our well known philosophy of 'High Fidelity Signal Management'. The 2011 series router frames and I/O board family incorporate new features, broader signal compatibility, more precise switching, control, troubleshooting and signal measurement.

The router frames start from 9x9 I/O size and increase up to 80x80. AV professionals can choose between various I/O sizes, video signal types and transport media options according to their system requirements thanks to our Hybrid Modular Design.

The future-proofed matrix backplanes are able to switch to 12.8 Gigabit per second data rates allowing transportation of the next generation HDMI, 4K x 2K, 3D and DisplayPort 1.1 video signals. All Input boards e.g. DVI-I, 3G-SDI, etc. convert their respective Input signals to the widest and broadest standard for all existing video signals – uncompressed HDMI (including embedded audio). Output boards convert the router's switched HDMI format to their respective output e.g. Fiber and Twisted Pair amongst others.

#### Model Denomination

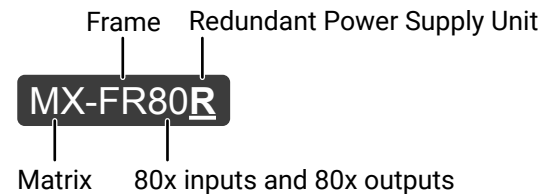



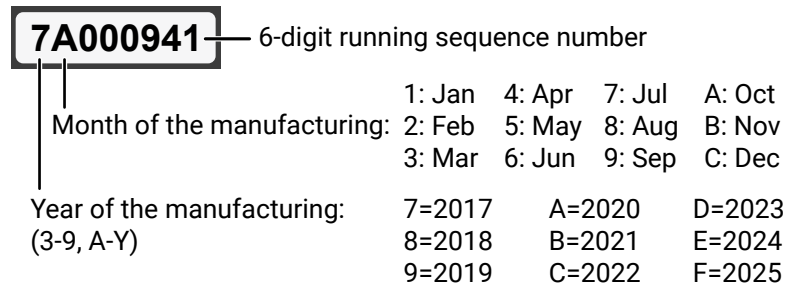

#### About the Serial Number

Lightware devices contain a label indicating the unique serial number of the product. The structure is the following:

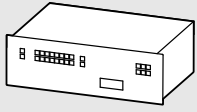
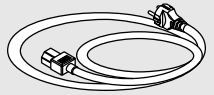
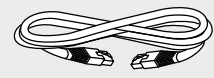
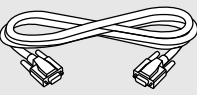

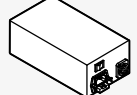
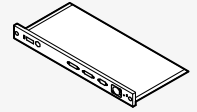
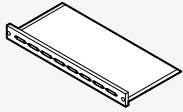
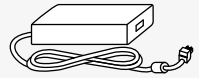
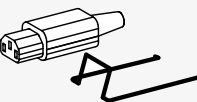
### 1.2. Box Contents

 Matrix Router Frame with Rack Mounting Ears	 IEC Power Cable <sup>1</sup>	 LAN Cross-link Cable, CAT5e type, 3 m length
 RS-232 Straight Serial Cable	 Safety and Warranty Info, Quick Start Guide	 Power Supply Unit(s) <sup>2</sup>
 MX-CPU2 Board <sup>3</sup>	 Router Input and Output Board(s) <sup>3</sup>	 48V External PSU for PoE Feature <sup>4</sup>
 Mounting Power Plug with Fixing Ears (2x) <sup>5</sup>	 Phoenix Combicon 5-pole Connector <sup>6</sup>	

<sup>1</sup> The AC plug type depends on the ordered configuration.  
<sup>2</sup> Supplied with matrix routers with redundant PSU (not supplied with MX-FR33L).  
<sup>3</sup> The supplied board types depend on the ordered configuration.  
<sup>4</sup> Default accessory for boards with TPS2 ports and PoE-compatible remote power feature.  
<sup>5</sup> Only in the case of MX-FR33R matrix.  
<sup>6</sup> Default accessory for boards with 5-pole Phoenix Analog Audio ports.

### 1.3. Features of the Device



#### Non-blocking Crosspoint Matrix Architecture

The router allows any input to be switched to any output or more outputs simultaneously.

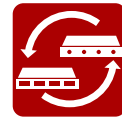

#### Hybrid Modular System

Custom I/O sizes with several types of input and output boards give the flexibility for interfacing with different video sources and displays.



#### 4K UHD & 3D Formats Support Without Latency

The MX Series supports the highest 4K UHD, 2560x1600 and 1920x1080@120Hz resolutions, standard HDMI 3D formats and all HDMI 1.3 resolutions, operating without signal latency.



#### Supports All HDTV Resolutions and HDCP

720p, 1080i and 1080p etc. signals are supported with or without HDCP encryption.



#### 3D Support

Lightware provides complex, integrated solutions for the digital age, also delivering 3D content in the case of certain I/O boards.



#### UMX Technology

UMX (Universal Matrix) technology was developed to support various analog and digital video and audio signal formats with several input connection possibilities.



#### HDCP Capability

Relevant I/O boards are fully HDCP compliant. Both HDCP-encrypted and non-HDCP components can be installed in the same system within the same chassis.



#### No Signal Latency With Zero Frame Delay

The signal management architecture ensures that there is no delay added between the input and the output.



#### Advanced EDID Management

The user can emulate any EDID on the inputs independently, read out and store any attached monitor's EDID in the internal memory locations.



#### Built-in Cable Compensation

Each DVI, HDMI or SDI input port contains an individual built-in cable extender.



#### Pixel Accurate Reclocking

Each output has a clean, jitter free signal, eliminating signal instability and distortion caused by long cables or connector reflections.



#### Frame Detector and Signal Analysis

The exact video and audio signal format can be determined such as timing, frequencies, scan mode, HDCP encryption, color range, color space and audio sample rate.



#### Remote Input Control over DDC (RICOD)

This technology is designed to switch inputs remotely on Lightware signal extenders without any additional control cabling. The RICOD master device can control the RICOD slave device connected to its input port.



#### DVI +5V Power Support

500 mA constant current output on each DVI or HDMI output to power long distance fiber optical cables or other DVI powered devices.



#### Redundant Power Supply

Accepting AC voltages from 100 to 240 Volts with 50 or 60 Hz line frequency on standard IEC connector. Redundant hot-swappable PSUs on selected models.

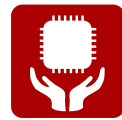

#### Power Failure Memory

The matrix router starts with its latest configuration settings when powered on or after a power failure. Every setting is stored in a non-volatile memory.



#### Front Panel Control

Sources and destinations have their own button to select. Single switches can be executed or crosspoint presets can be saved and reloaded. Almost every setting can be configured through the front panel LCD menu.

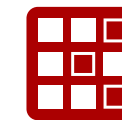

#### Lightware Device Controller (LDC)

The LDC application keeps receiving upgrades, adding new features and tools. The LDC is available for both Windows and mac OS X operating systems.



#### Built-in Website

Easy access from a web browser to control and configure the matrix in systems where software is not allowed to install.



#### Ethernet Control

Multiple simultaneous TCP/IP connections are available with simple ASCII based protocol for controlling and configuring the matrix router.



#### USB Control

Easily accessible front panel USB configuration port.



#### RS-232 or RS-422 Control

Simple ASCII-based protocol can be used for switching, preset calling, status request, etc.



#### TPS Cable Diagnostic Tool

The tool within the LDC software will help you identify potential twisted pair cable issues in your TPS-capable (HDBaseT®-compliant) system.



### 1.4. Typical Applications

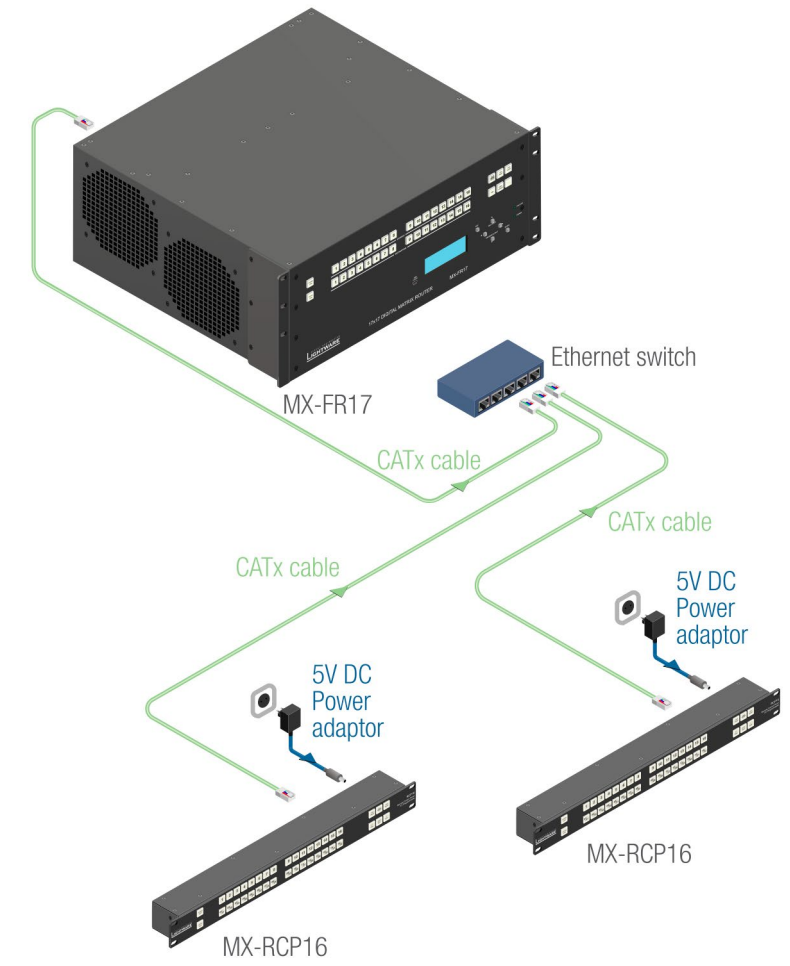
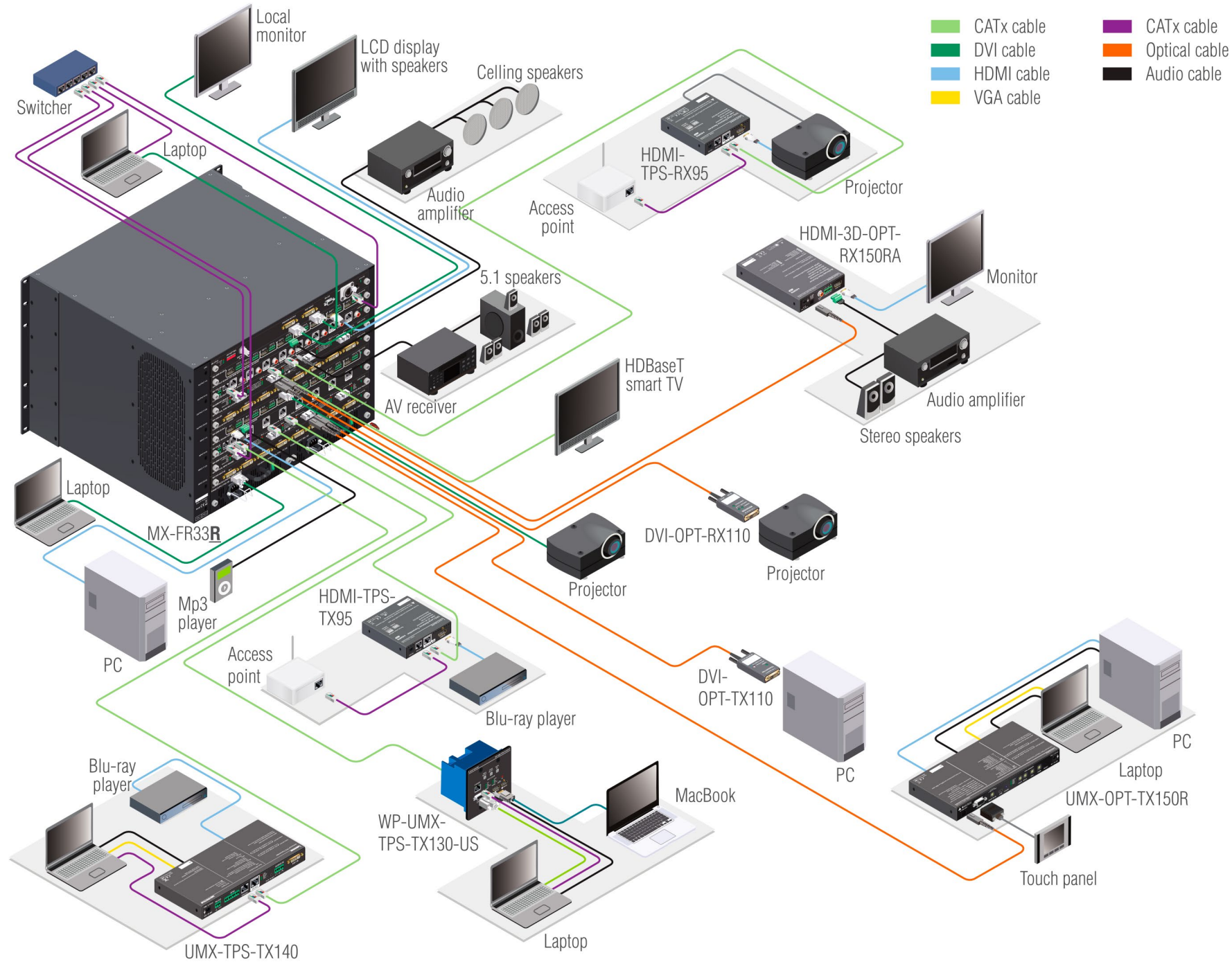

**Integrated System Application (left) and Applying Remote Control Panels (above)**

# 2

## Installation

The chapter is about the installation of the device and connecting to other appliances, presenting also the mounting options.

- ▶ MOUNTING OPTIONS
- ▶ CONNECTING STEPS
- ▶ BOARD INSTALLATION AND HANDLING
- ▶ PSU INSTALLATION AND HANDLING

### 2.1. Mounting Options

**WARNING!** For the correct ventilation and to avoid overheating ensure enough free space around the appliance. Do not cover the appliance, let the ventilation holes free and never block or bypass the fans.

The front rack ears allow to mount the device as a standard rack unit installation. Use such type (and size) of screw that fits to the rack rails.

The dimensions of the frames can be found in the [Mechanical Drawings](#) section.

**TIPS AND TRICKS:** Pay attention to the rear side of the matrix! Let enough free space to (un)plug the cables and/or replace an I/O board without moving the matrix!

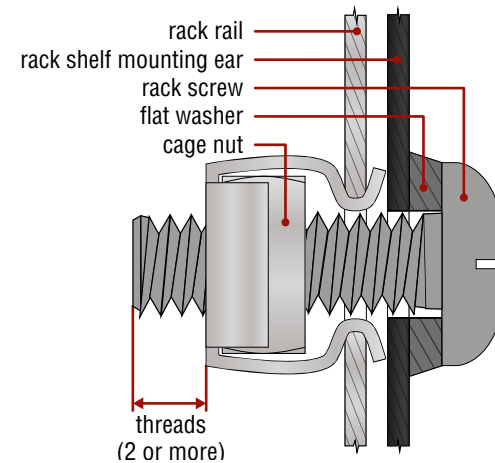
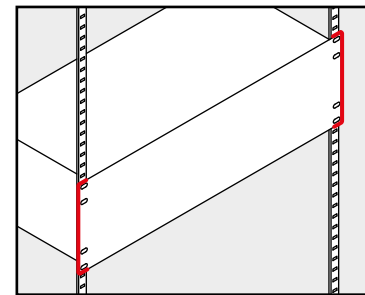

**ATTENTION!** Fix the frame to the rack rail by applying all mounting holes. Choose properly sized screws for mounting. Keep minimum two threads left after the nut screw.

Frame type	The number of the mounting holes
MX-FR9, MX-FR9R	2x4 pcs.
MX-FR17, MX-FR17R	
MX-FR33L, MX-FR33R	2x6 pcs.
MX-FR65R	
MX-FR80R	

### 2.2. Connecting Steps

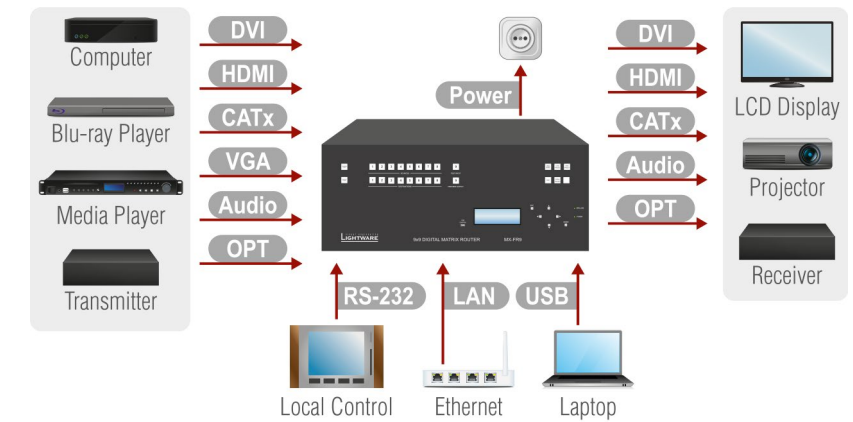

**DVI**  
**HDMI**  
**VGA**  
**Audio**  
**CATx**  
**OPT**

Connect the desired Audio/Video/Extender devices to the ports of the I/O ports. Connecting powered off devices is recommended.

**LAN**  
**USB**  
**RS-232**

Connect the desired Controlling devices for local/remote control options.

**Power**

Connect the power cord to the AC power socket and to the matrix. Switch it on and all the connected devices.

To access the matrix and I/O port settings via Lightware Device Controller software see the [Software Control – Lightware Device Controller Software](#) section.

To access the matrix and I/O port settings by sending Lightware protocol (LW2) commands see the [Programmer's Reference](#) section.

## 2.3. Board Installation and Handling

**WARNING!** The I/O boards and the CPU board are not hot-swappable. The matrix must be powered off before removing/inserting a board.

### Important Notices about the Boards

Pay attention to the places of the boards: CPU/input/output boards have different connectors on the motherboard in the matrix, thus, they have dedicated slots as indicated in the rear plate. In general:

- CPU board is placed in the top position always.
- Output boards are located below the CPU board.
- Input boards are located in the bottom slots.

### Installing a Board

**Step 1.** Make sure the matrix is powered off.

**Step 2.** Loose the fixing screws and remove the blank cover or the previously installed board.



**Step 3.** Take the board by touching the metal plate only, to prevent ESD-caused problems.

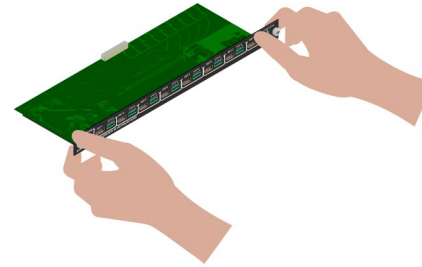

**Step 4.** Insert the edge of the board in the slot at both sides.



**Step 5.** Gently push the board in until it stops, then press the plate at the indicated places at once. Thus, the connector of the board and the motherboard will be put together.



**Step 6.** Tighten the two screws by hand and fix them by a screwdriver with PZ1 head.

**INFO:** The mute-, lock-, and crosspoint states are stored in the matrix, all other I/O board-related settings are stored by I/O board series. (An I/O board and its variants with Audio add-on mean the I/O board series.) E.g. if an MX-TPS-IB had been installed previously in a matrix and an MX-TPS-IB-A board was installed later, the previous settings would be applied to the board.



## 2.4. PSU Installation and Handling

### MX-FR80R and MX-FR65R Frames

The PSU of these frames is hot-swappable, thus, you do not have to switch off the matrix to replace or install a PSU.

Three slots are available for the FNP-850-12RG PSUs. The load depend on the installed I/O boards, so the best practice for a PSU replacement is to have two PSUs in use continuously. Thus, the third PSU can be replaced safely:

- Step 1.** Unplug the **power cord** from the AC socket, then from the desired PSU.
- Step 2.** Loosen the **fixing screw** of the PSU by hand and/or a flat-head screwdriver.

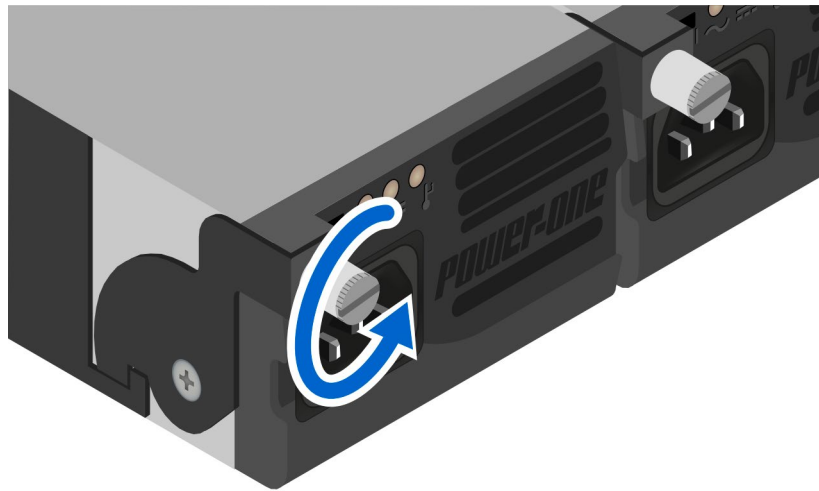

#power

#redundancy

- Step 3.** Pull down the lever (1), then pull out (2) the PSU unit by grabbing the screw/lever.

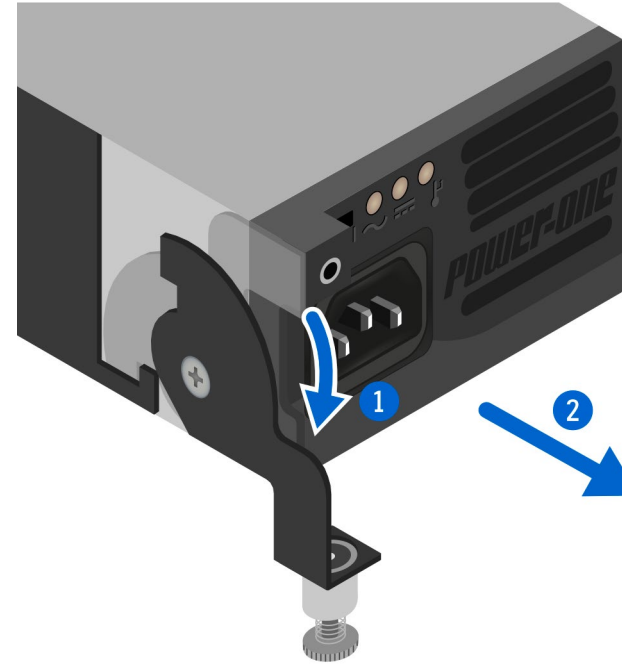

- Step 4.** To install another PSU: insert the unit in the slot, and push it until it stops.
- Step 5.** Push up the lever, tighten the locking screw by hand and fix it by a flat-head screwdriver.
- Step 6.** Plug the power cord to the PSU, then to the AC socket.

### MX-FR33R Frame

Two types of PSUs exist for MX-FR33R frames. Both can supply the frame, but the two units are not interchangeable with each other. See more details in the [Redundant Power Supplies](#) section.

**ATTENTION!** The MX-PSU-350 type is hot-swappable, thus, you do not have to turn off the matrix to replace a PSU. Former type of PSUs do not support this feature.

The MX-PSU-350 PSU of the MX-FR33R frame can be replaced similarly as the I/O boards, since the PSUs have the same type of fixing screws:

- Step 1.** Switch off the desired PSU (1) and unplug the power cord from the AC socket
- Step 2.** Take out the cord-fixing insert (2) from the PSU and pull out the power cord.
- Step 3.** Loosen the fixing screws (3), then pull out the PSU.

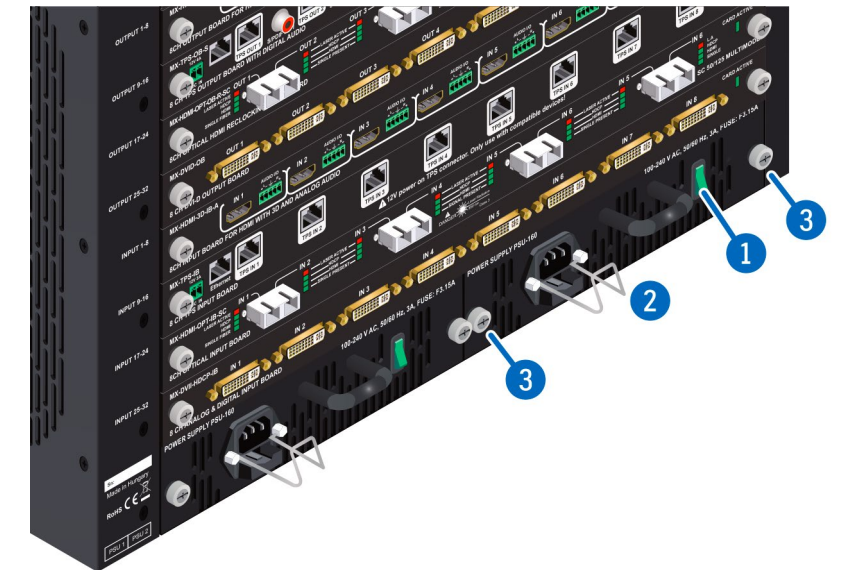

- Step 4.** Insert the new PSU, push it until it stops.
- Step 5.** Tighten the two screws by hand and fix them by a screwdriver with PZ1 head.

# 3

## Product Overview

The following sections are about the physical structure of the device, input/output ports and connectors:

- ▶ [HYBRID MODULAR MATRIX CONCEPT](#)
- ▶ [ROUTER FRAMES](#)
- ▶ [I/O BOARD CONFIGURATIONS](#)
- ▶ [MX-CPU2 PROCESSOR BOARD](#)
- ▶ [INPUT BOARDS](#)
- ▶ [OUTPUT BOARDS](#)
- ▶ [MX-FR80R AND MX-FR65R](#)
- ▶ [MX-FR33R](#)
- ▶ [MX-FR33L](#)
- ▶ [MX-FR17](#)
- ▶ [MX-FR17R](#)
- ▶ [MX-FR9](#)
- ▶ [MX-FR9R](#)
- ▶ [ELECTRICAL CONNECTIONS](#)
- ▶ [INPUT BOARDS](#)
- ▶ [OUTPUT BOARDS](#)

### 3.1. Hybrid Modular Matrix Concept

Lightware's hybrid modular matrix routers allow building custom I/O sizes which meets the user's requirements. Different types of input and output boards give the maximum flexibility for rental and installation signal transmission. The hybrid architecture allows signal routing between boards even if they have different connectors. This way any input can be routed to any or more outputs if the output interface is capable of transmitting the signal. For example, a DVI source can be routed to an HDMI sink, but HDCP-encrypted sources cannot be routed to non-HDCP capable DVI sinks.

Available interface types include DVI-D single- and dual-link, HDMI, fiber, and twisted pair cables as well.

### 3.2. Router Frames

Different frame sizes are available from 9x9 up to 80x80. To fit user needs various input and output interface boards are available, that can be mixed in the same frame without limitation.

Frame type	Rack height	Max. input boards	Max. input ports	Max. output boards	Max. output ports
MX-FR9	4U	1	9	1	9
MX-FR9R	4U	1	9	1	9
MX-FR17	4U	2	17	2	17
MX-FR17R	4U	2	17	2	17
MX-FR33L	6U	4	33	4	33
MX-FR33R	7U	4	33	4	33
MX-FR65R	15U	8	65	8	65
MX-FR80R	15U	10	80	10	80

INFO: The maximum number of input and output ports includes the Test input and Preview output port of the MX-CPU2 processor board.

### 3.3. I/O Board Configurations

The mute-, lock-, and crosspoint states are stored in the matrix, all other I/O board-related settings are stored by I/O board series. An I/O board and its variants with Audio add-on mean the I/O board series. E.g. if an MX-TPS-IB had been installed previously in a matrix and an MX-TPS-IB-A board was installed later, the previous settings would be applied to the board.

### 3.4. MX-CPU2 Processor Board

The CPU board is necessary for the router frame to work. This board is responsible for controlling the matrix and storing the settings.

#### Test Input and Preview Output Ports

The MX-CPU2 board has a **TEST INPUT** and a **PREVIEW OUTPUT** port. Although these ports have special functions they can be used as normal I/O ports as well. These ports are HDMI and HDCP capable.

#### MX-FR80R and MX-FR65R

Used in the MX-FR80R (and MX-FR65R) router frame, the Preview output is directly connected to the 80th output port with a DVI splitter. Therefore this port always outputs the same signal as the 80th output (the 8th port of the 10th output board), even if it uses a different interface (TP, OPT, etc.).

The 80th input port of the crosspoint is multiplexed between the Test input port and the 8th port of the 10th input board. This switch is independent from the crosspoint state. The selected port (Test input or Input board #10) will be available as the 80th input on the crosspoint switch.

#### Other Frames

All other frames use the Test input and Preview output just like any other ports. These ports are referred as the last port in the crosspoint.

Frame Type	Test Input	Preview Output
MX-FR9	in 9	out 9
MX-FR9R	in 9	out 9
MX-FR17	in 17	out 17
MX-FR17R	in 17	out 17
MX-FR33L	in 33	out 33
MX-FR33R	in 33	out 33
MX-FR65R	in 80	out 80
MX-FR80R	multiplexed in 80	distributed out 80

#### Other Connectors

The MX-CPU2 board has Ethernet, serial, and alarm ports as well.

### MX-FR65R Limitations

The MX-FR65R matrix frame is physically identical to the MX-FR80R. The only difference is a limitation on the number of allowed I/O boards. While the MX-FR80R can work with 10 input and 10 output boards the MX-FR65R allows only 8.

The frame has 10 physical board slots but will not boot up when more than 8 input or output boards are inserted. Only the number of boards is limited thus they can be used in any of the physical slots. However to gain exclusive access to the Test input and Preview output ports on the MX-CPU2 it is recommended to leave the last slot empty.

For example, if the input slot #1 is empty, there can be 8 input boards in slots #2 to #9 and the slot #10 left empty. In this case the 65 input ports can be accessed with port numbers 9-72 and 80.

#### 3.4.1. MX-CPU2 Board Features

Lightware MX-CPU2 processor board fits into Lightware hybrid modular matrix routers:

Older models	New models
MX16x16DVI-Pro	MX-FR9
MX32x32DVI-Pro	MX-FR9R
MX32x32HDMI-Pro	MX-FR17
MX16x16HDMI-Pro	MX-FR17R
MX32x32DVI-HDCP-Pro	MX-FR33(L)
MX16x16DVI-HDCP-Pro	MX-FR33R
MX-DVI-FR16	MX-FR65R
MX-DVI-FR32	MX-FR80R
MX-DVI-FR32R	

All older models can be upgraded with MX-CPU2 processor board.

#### Changes with MX-CPU2 upgrade

- **Extra I/O ports** – Get an additional DVI-HDCP input and output port.
- **Ethernet control** – Multiple simultaneous TCP/IP Ethernet connections.
- **Combine HDCP and non-HDCP boards** – Any interface board combination is possible in the same frame.

## 3.5. Input Boards

Several input interface boards are available. Each model has different capabilities and functions. Below table shows a summary of the main features.

Model	Default Connectors	Optional Connectors	HDMI Capability	HDCP Capability	EDID Emulation	Cable EQ
MX-DVID-IB	8x DVI-I (D) <sup>1</sup>	-	-	-	✓	✓
MX-DVI-4K-IB	8x DVI-I (D) <sup>1</sup>	-	✓	✓	✓	✓
MX-DVI-TP-IB	8x RJ45	-	-	-	-	✓
MX-DVI-TP-IB+	8x RJ45 double	-	-	-	✓	✓
MX-DVI-OPT-IB-...	8x optical	-	-	-	-	-
MX-DVIDL-IB	4x DVI-I (D) (dual link)	-	-	-	✓	✓
MX-DVIDL-OPT-IB-...	4x optical (dual link)	-	-	-	-	-
MX-DVI-HDCP-IB	8x DVI-I (D) <sup>1</sup>	-	✓	✓	✓	✓
MX-DVII-HDCP-IB	8x DVI-I	-	✓	✓	✓	✓ <sup>2</sup>
MXD-UMX-IB	8x DVI-I	Phoenix, S/PDIF	✓	✓	✓	✓ <sup>2</sup>
MX-HDMI-IB	8x HDMI	-	✓	✓	✓	✓
MX-HDMI-TP-IB	8x RJ45 double	-	✓	✓	✓	✓
MXD-HDMI-TP-IB	8x RJ45 double	RS-232, S/PDIF	✓	✓	✓	✓
MX-HDMI-OPT-IB-...	8x optical	-	✓	✓	-	-
MX-3GSDI-IB	8x BNC, S/PDIF	-	✓	-	-	✓
MX-CPU2 Test Input	1x DVI-I (D) <sup>1</sup>	-	✓	✓	✓	-
MX-TPS-IB, -A, -S	8x TPS	Phoenix, S/PDIF	✓	✓	✓	✓ <sup>3</sup>
MX-HDMI-3D-IB, -A, -S	8x HDMI	Phoenix, S/PDIF	✓	✓	✓	✓ <sup>3</sup>
MX-TPS2-IB-P, -AP, -SP	8x TPS	Phoenix, S/PDIF	✓	✓	✓	✓ <sup>3</sup>
MX-4TPS2-4HDMI-IB, -A, -S	4x TPS, 4x HDMI	Phoenix, S/PDIF	✓	✓	✓	✓ <sup>3</sup>
MX-4TPS2-4HDMI-IB-P, -AP, -SP	4x TPS <sup>4</sup> , 4x HDMI	Phoenix, S/PDIF	✓	✓	✓	✓ <sup>3</sup>

<sup>1</sup> Any DVI connector can be plugged in but only digital pins are connected.

<sup>2</sup> Limited cable equalization. See details in the specifications.

<sup>3</sup> Cable EQ by HDBaseT™ on the TPS ports.

<sup>4</sup> With PoE-compatible (Power over Ethernet) remote power feature.

### 3.6. Output Boards

Several output interface boards are available. Each model has different capabilities and functions. The table below shows a summary of the main features.

Model	Default Connectors	Optional Connectors	HDMI Capability	HDCP Capability	EDID Reading	Re-clocking
MX-DVID-OB	8x DVI-I (D) <sup>1</sup>	-	-	-	✓	✓
MX-DVI-4K-OB	8x DVI-I (D) <sup>1</sup>	-	✓	✓	✓	✓
MX-DVI-TP-OB	8x RJ45	-	-	-	-	✓
MX-DVI-TP-OB+	8x RJ45 double	-	-	-	✓	✓
MX-DVI-OPT-OB-...	8x optical	-	-	-	-	-
MX-DVIDL-OPT-OB...	4x optical (dual link)	-	-	-	-	-
MX-DVI-OPT-OB-R...	8x optical	-	-	-	-	✓
MX-DVIDL-OB	4x DVI-I (D) (dual link) <sup>1</sup>	-	-	-	✓	✓
MX-DVI-HDCP-OB	8x DVI-I (D) <sup>1</sup>	-	✓	✓	✓	✓
MX-HDMI-OB	8x HDMI, S/PDIF	-	✓	✓	✓	✓
MX-HDMI-TP-OB	8x RJ45 double	-	✓	✓	✓	✓
MXD-HDMI-TP-OB	8x RJ45 double	RS-232, S/PDIF	✓	✓	✓	✓
MX-HDMI-OPT-OB-...	8x optical	-	✓	✓	✓	-
MX-CPU2 Preview Out	1x DVI-I (D) <sup>1</sup>	-	✓	✓	✓	✓
MX-HDMI-3D-OB, -A, -S	8x HDMI	Phoenix, S/PDIF	✓	✓	✓	✓
MX-HDMI-OPT-OB-R...	8x optical	-	✓	✓	✓	✓
MX-TPS-OB, -A, -S	8x TPS	Phoenix, S/PDIF	✓	✓	✓	✓
MX-TPS2-OB-P, -AP, -SP	8x TPS <sup>2</sup>	Phoenix, S/PDIF	✓	✓	✓	✓
MX-AUDIO-OB-A	8x Phoenix	-	✓	✓	✓	✓
MX-4TPS2-4HDMI-OB, -A, -S	4x TPS, 4x HDMI	Phoenix, S/PDIF	✓	✓	✓	✓
MX-4TPS2-4HDMI-OB-P, -AP, -SP	4x TPS, 4x HDMI	Phoenix, S/PDIF	✓	✓	✓	✓

<sup>1</sup> Any DVI connector can be plugged in but only digital pins are connected.

<sup>2</sup> With PoE-compatible remote power feature.

**WARNING! Please make sure that all slots contain a board or a blank plate during usage (MX-BLANK-IO, part no: 52400115).**

### 3.7. MX-FR80R and MX-FR65R

#### Front View

- |   |                            |   |
|---|----------------------------|---|
| ① | <b>Menu display</b>        | Displays status information and menu operation.   |
| ② | <b>Menu navigation</b>     | Up, down, left, right, escape, and enter buttons for menu navigation.   |
| ③ | <b>Status LEDs</b>         | CPU live LED blinks to indicate normal operation. Power LED lights green when the router is powered on.   |
| ④ | <b>USB control</b>         | USB connection for Lightware Device Controller Software.  |
| ⑤ | <b>Take / Auto</b>         | Displays the actual switching mode of the router (TAKE or AUTOTAKE). Long press toggles the switching mode, short press executes switching in TAKE mode.                |
| ⑥ | <b>Preset buttons</b>      | Load preset: apply a previously saved crosspoint preset from one of the preset memories.<br>Save preset: stores actual crosspoint state, in one of the preset memories. |
| ⑦ | <b>Signal present</b>      | Displays live sources and attached sinks on source and destination buttons.   |
| ⑧ | <b>EDID mode</b>           | Switches the Menu display to EDID menu allowing EDID switch, EDID save etc.   |
| ⑨ | <b>Control lock</b>        | Disables or enables front panel operation. When red is illuminated, all operations on front panel are prohibited.   |
| ⑩ | <b>Output lock</b>         | Locks and protects one (or more) outputs. Inhibits accidental input changing on protected output.   |
| ⑪ | <b>Source buttons</b>      | Source buttons have three functions: to select an input, to select a preset and to view the selected input's state (only in TAKE mode).                                 |
| ⑫ | <b>Destination buttons</b> | Destination buttons have two functions: to select an output, or to view the selected output's state.  |

**ATTENTION!** In the case of the MX-FR65R matrix the attached label can be seen on the front panel.

Configured as  
MX-FR65R

**INFO:** The unlabeled buttons are disabled and reserved for future developments.

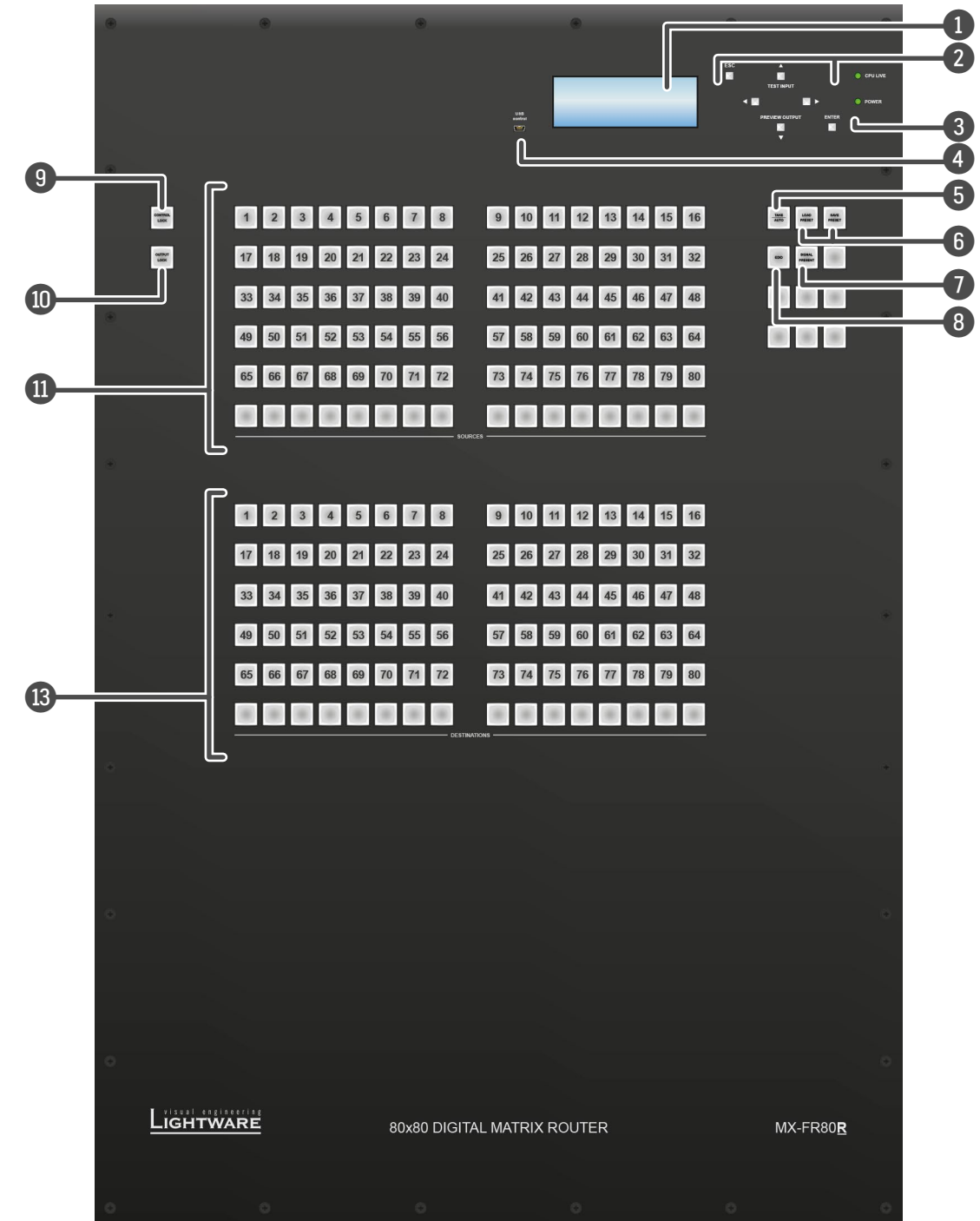



Rear View

- 1 **Status LEDs** LED indicators for internal DC power voltages and alarm.
- 2 **DIP settings** Special settings can be made with these switches.
- 3 **Alarm out** Standard SMPTE 269M alarm output with BNC connector. See the [Alarm Output](#) section for more information.
- 4 **Preview output** DVI output connector, which is directly connected to the 80th output. See the [DVI Inputs and Outputs](#) and the [Test Input and Preview Output](#) sections for more information.
- 5 **Test input** DVI input connector, which can be configured as an alternative for the 80th input. See the [DVI Inputs and Outputs](#) and the [Test Input and Preview Output](#) sections.
- 6 **Serial port** 9-pole D-SUB female connector for RS-232 serial connection. See the [RS-232 Ports](#) section for more information.
- 7 **Ethernet port** Locking RJ45 connector. Remote control port for connecting the unit to Local Area Network (LAN) and firmware upgrade can be also performed over this interface. See the [Ethernet Ports](#) section for more information.
- 8 **Reset button** Reset button reboots the matrix. This is same as disconnecting from power source, and reconnect again.
- 9 **CPU live** CPU live LED blinks to indicate normal operation.
- 10 **Input boards** Modular input board slots. Connect source devices to these connectors.
- 11 **Output boards** Modular output board slots. Connect sink devices to these connectors.
- 12 **Power supplies** Hot swap slots for power supply units. See the [Powering on](#) section for more information.

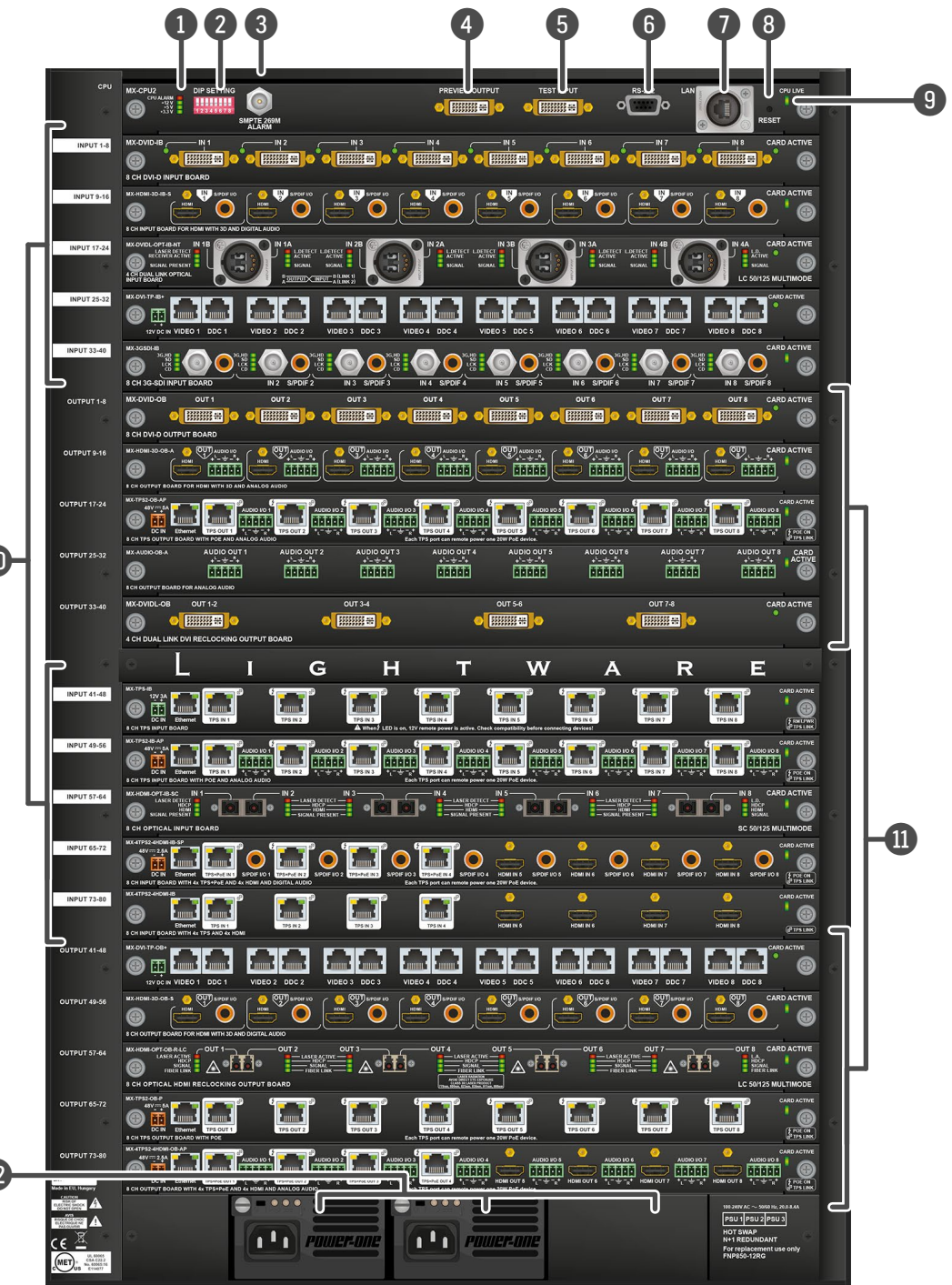

INFO: The MX-FR65R is shipped with 2 power supply units and the rightmost PSU slot is covered with a blank metal plate.

INFO: The MX-FR65R has a label showing that maximum 8 input and output boards are allowed.

**Maximum allowed**  
**Input boards: 8**  
**Output boards: 8**



### 3.8. MX-FR33R

#### Front View

- 1 **USB control** USB connection for Lightware Device Controller software.
- 2 **Menu display** Displays status information and menu operation.
- 3 **Menu navigation** Arrows, escape, and enter buttons for menu navigation.
- 4 **Status LEDs** CPU live LED blinks to indicate normal operation. Power LED lights green when the router is powered on.
- 5 **Control lock** Press long to disable or enable front panel buttons. When red is illuminated, all operations on front panel are prohibited.
- 6 **Output lock** Locks one (or more) outputs. Inhibits accidental input changing on protected output.
- 7 **Source buttons** Source buttons can be used to select an input or preset or to view the selected input's state.
- 8 **Destination buttons** Destination buttons can be used to select an output, or view the selected output's state.
- 9 **Take / Auto** Displays the actual switching mode (TAKE or AUTOTAKE). Long press toggles the switching mode, short press executes switching in TAKE mode.
- 10 **Preset buttons** Load preset: apply a previously saved crosspoint preset from one of the preset memories. Save preset: stores actual crosspoint state, in one of the preset memories.
- 11 **EDID mode** Switches the Menu display to EDID menu allowing EDID switch, EDID save etc.
- 12 **Signal present** Displays live sources and attached sinks on source and destination buttons.

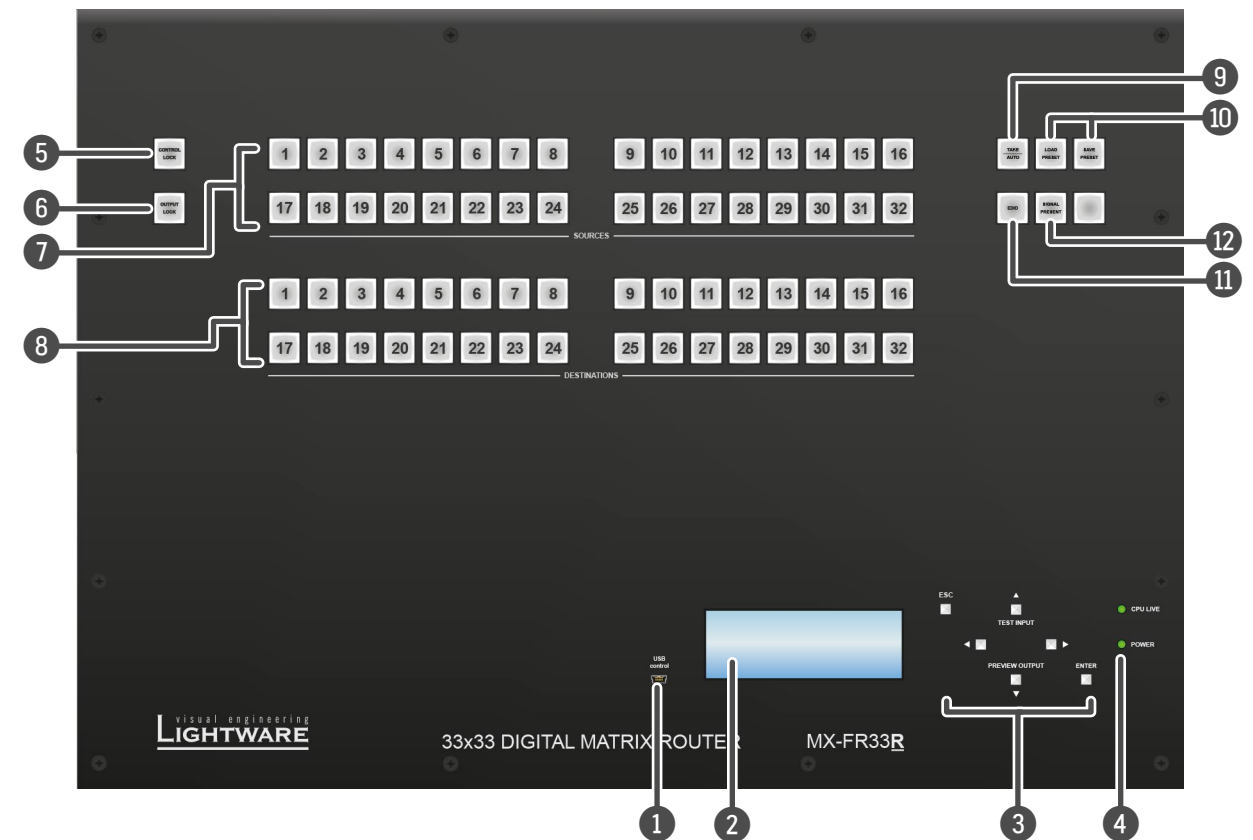

## Rear View

- 1 **Status LEDs** LED indicators for internal DC power voltages and alarm.
- 2 **DIP settings** Special settings can be made with these switches.
- 3 **Alarm out** Standard SMPTE 269M alarm output with BNC connector. See the [Alarm Output](#) section for more information.
- 4 **Preview output** DVI output connector, which is directly connected to the 33rd output. See the [DVI Inputs and Outputs](#) and the [Test Input and Preview Output](#) sections for more information.
- 5 **Test input** DVI input connector, which can be configured as an alternative for the 33rd input. See the [DVI Inputs and Outputs](#) and the [Test Input and Preview Output](#) sections.
- 6 **Serial port** 9 pole D-SUB female connector for RS-232 serial connection. See the [RS-232 Ports](#) section for more information.
- 7 **Ethernet port** Locking RJ45 connector. Remote control port for connecting the unit to Local Area Network (LAN) and firmware upgrade can be also performed over this interface. See the [Ethernet Ports](#) section for more information.
- 8 **Reset button** Reset button reboots the matrix. This is same as disconnecting from power source, and reconnect again.
- 9 **CPU live** CPU live LED blinks to indicate normal operation.
- 10 **Output boards** Modular output board slots. Connect sink devices to these connectors.
- 11 **Input boards** Modular input board slots. Connect source devices to these connectors.
- 12 **Power supplies** Hot swap slots for power supply units. See the [Powering on](#) section for more information.

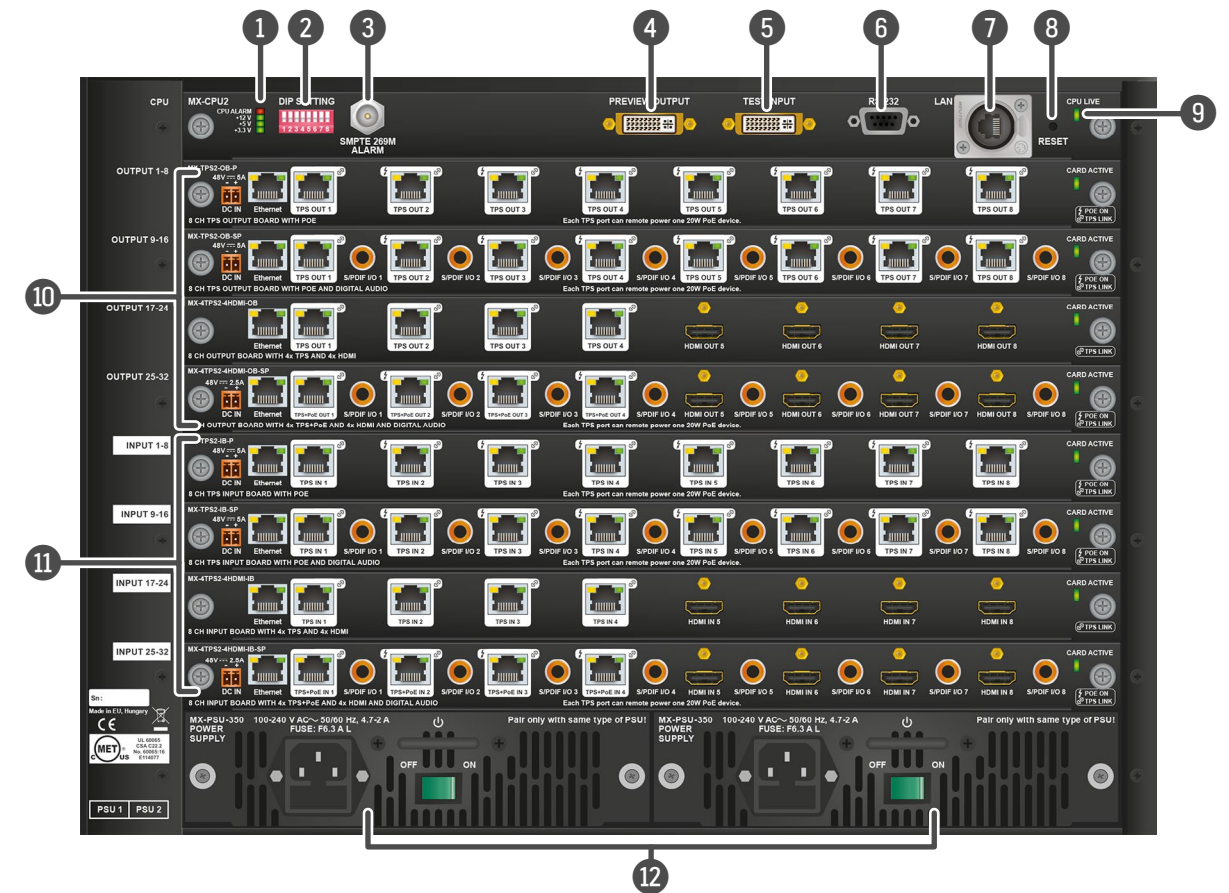

### 3.9. MX-FR33L

#### Front View

- |   |                            |  |
|---|----------------------------|--|
| ① | <b>USB control</b>         | USB connection for Lightware Device Controller software.   |
| ② | <b>Menu display</b>        | Displays status information and menu operation.  |
| ③ | <b>Menu navigation</b>     | Arrows, escape, and enter buttons for menu navigation.   |
| ④ | <b>Status LEDs</b>         | CPU live LED blinks to indicate normal operation. Power LED lights green when the router is powered on.  |
| ⑤ | <b>Control lock</b>        | Press long to disable or enable front panel buttons. When red is illuminated, all operations on front panel are prohibited.  |
| ⑥ | <b>Output lock</b>         | Locks one (or more) outputs. Inhibits accidental input changing on protected output.   |
| ⑦ | <b>Source buttons</b>      | Source buttons can be used to select an input or preset or to view the selected input's state.   |
| ⑧ | <b>Destination buttons</b> | Destination buttons can be used to select an output, or view the selected output's state.  |
| ⑨ | <b>Take / Auto</b>         | Displays the actual switching mode (TAKE or AUTOTAKE). Long press toggles the switching mode, short press executes switching in TAKE mode.                           |
| ⑩ | <b>Preset buttons</b>      | Load preset: apply a previously saved crosspoint preset from one of the preset memories. Save preset: stores actual crosspoint state, in one of the preset memories. |
| ⑪ | <b>EDID mode</b>           | Switches the Menu display to EDID menu allowing EDID switch, EDID save etc.  |
| ⑫ | <b>Signal present</b>      | Displays live sources and attached sinks on source and destination buttons.  |

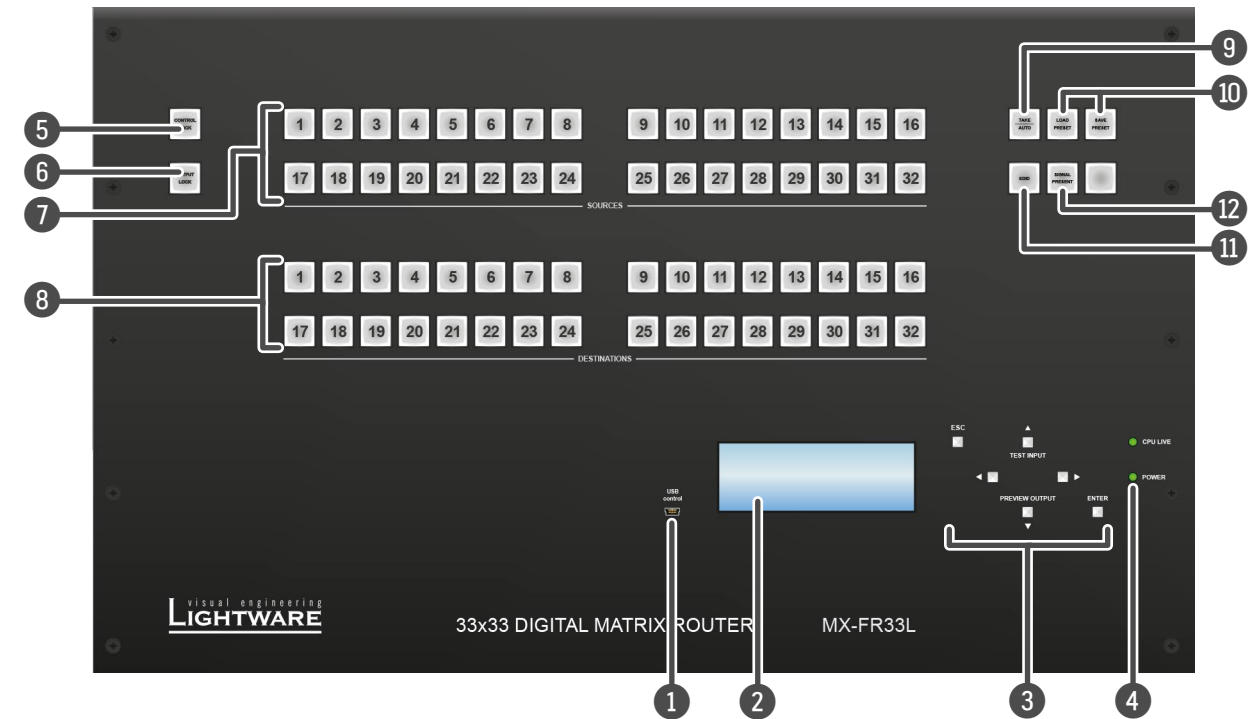

## Rear View

- 1 **Status LEDs** LED indicators for internal DC power voltages and alarm.
- 2 **DIP settings** Special settings can be made with these switches.
- 3 **Alarm out** Standard SMPTE 269M alarm output with BNC connector. See the [Alarm Output](#) section for more information.
- 4 **Preview output** DVI output connector, which is directly connected to the 33rd output. See the [DVI Inputs and Outputs](#) and the [Test Input and Preview Output](#) sections for more information.
- 5 **Test input** DVI input connector, which can be configured as an alternative for the 33rd input. See the [DVI Inputs and Outputs](#) and the [Test Input and Preview Output](#) sections.
- 6 **Serial port** 9 pole D-SUB female connector for RS-232 serial connection. See the [RS-232 Ports](#) section for more information.
- 7 **Ethernet port** Locking RJ45 connector. Remote control port for connecting the unit to Local Area Network (LAN) and firmware upgrade can be also performed over this interface. See the [Ethernet Ports](#) section for more information.
- 8 **Reset button** Reset button reboots the matrix. This is same as disconnecting from power source, and reconnect again.
- 9 **CPU live** CPU live LED blinks to indicate normal operation.
- 10 **Output boards** Modular output board slots. Connect sink devices to these connectors.
- 11 **Input boards** Modular input board slots. Connect source devices to these connectors.
- 12 **Power** Mains switch and AC power connector.





### 3.10. MX-FR17

Front View

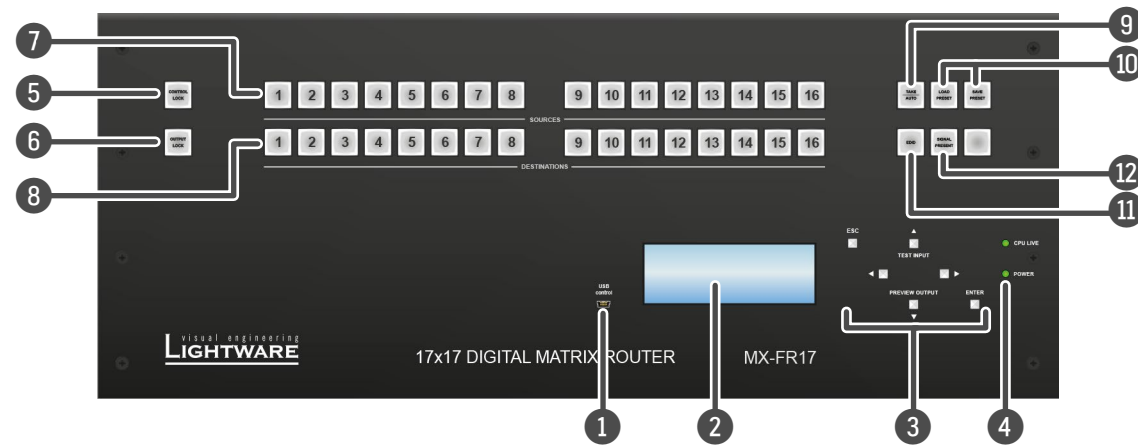

- |  |  |
|--|--|
| <p><b>1 USB control</b> USB connection for Lightware Device Controller software.</p> <p><b>2 Menu display</b> Displays status information and menu operation.</p> <p><b>3 Menu navigation</b> Arrows, escape, and enter buttons for menu navigation.</p> <p><b>4 Status LEDs</b> CPU live LED blinks to indicate normal operation. Power LED lights green when the router is powered on.</p> <p><b>5 Control lock</b> Press long to disable or enable front panel buttons. When red is illuminated, all operations on the front panel are prohibited.</p> <p><b>6 Output lock</b> Locks one (or more) outputs. Inhibits accidental input changing on protected output.</p> <p><b>7 Source buttons</b> Select an input or preset or to view the selected input's state.</p> | <p><b>8 Destination buttons</b> Destination buttons can be used to select an output, or view the selected output's state.</p> <p><b>9 Take / Auto</b> Displays the actual switching mode (TAKE or AUTOTAKE). Long press toggles the switching mode, short press executes switching in TAKE mode.</p> <p><b>10 Preset buttons</b> Load preset: apply a previously saved crosspoint preset from one of the preset memories. Save preset: stores actual crosspoint state, in one of the preset memories.</p> <p><b>11 EDID mode</b> Switches the Menu display to EDID menu allowing EDID switch, EDID save etc.</p> <p><b>12 Signal present</b> Displays live sources and attached sinks on source and destination buttons.</p> |
|--|--|

Rear View

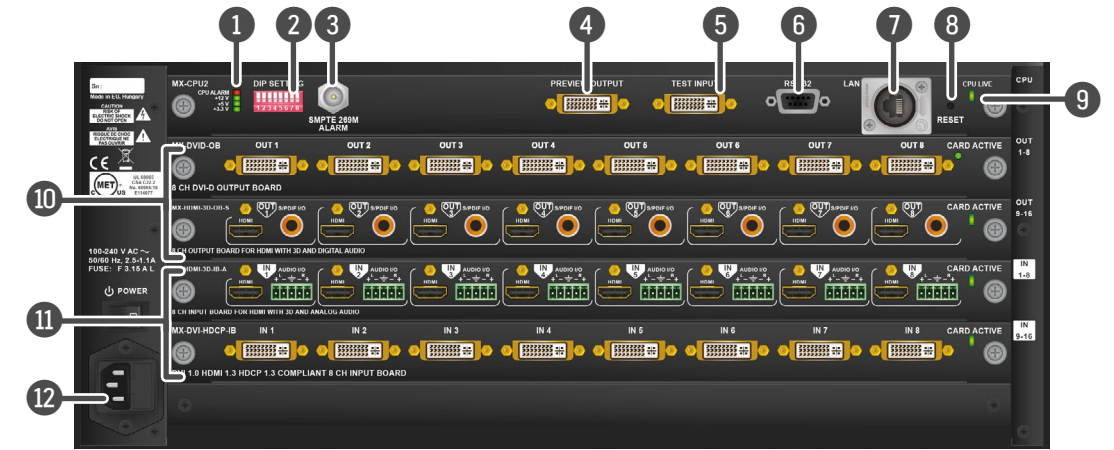

- |  |   |
|--|---|
| <p><b>1 Status LEDs</b> LED indicators for internal DC power voltages and alarm.</p> <p><b>2 DIP settings</b> Special settings can be made with these switches.</p> <p><b>3 Alarm out</b> Standard SMPTE 269M alarm output with BNC connector. See the <a href="#">Alarm Output</a> section for more information.</p> <p><b>4 Preview output</b> DVI output connector, which is directly connected to the 17th output. See the <a href="#">DVI Inputs and Outputs</a> and the <a href="#">Test Input and Preview Output</a> sections for more information.</p> <p><b>5 Test input</b> DVI input connector, which can be configured as an alternative for the 17th input. See the <a href="#">DVI Inputs and Outputs</a> and the <a href="#">Test Input and Preview Output</a> sections.</p> <p><b>6 Serial port</b> 9 pole D-SUB female connector for RS-232 serial connection. See the <a href="#">RS-232 Ports</a> section for more information.</p> | <p><b>7 Ethernet port</b> Locking RJ45 connector. Remote control port for connecting the unit to Local Area Network (LAN) and for firmware upgrade. See the <a href="#">Ethernet Ports</a> section for more information.</p> <p><b>8 Reset button</b> Reset button reboots the matrix. This is same as disconnecting from power source, and reconnect again.</p> <p><b>9 CPU live</b> CPU live LED blinks to indicate normal operation.</p> <p><b>10 Output boards</b> Modular output board slots. Connect sink devices to these connectors.</p> <p><b>11 Input boards</b> Modular input board slots. Connect source devices to these connectors.</p> <p><b>12 Power</b> Mains switch and AC power connector.</p> |
|--|---|

### 3.11. MX-FR17R

Front View #new

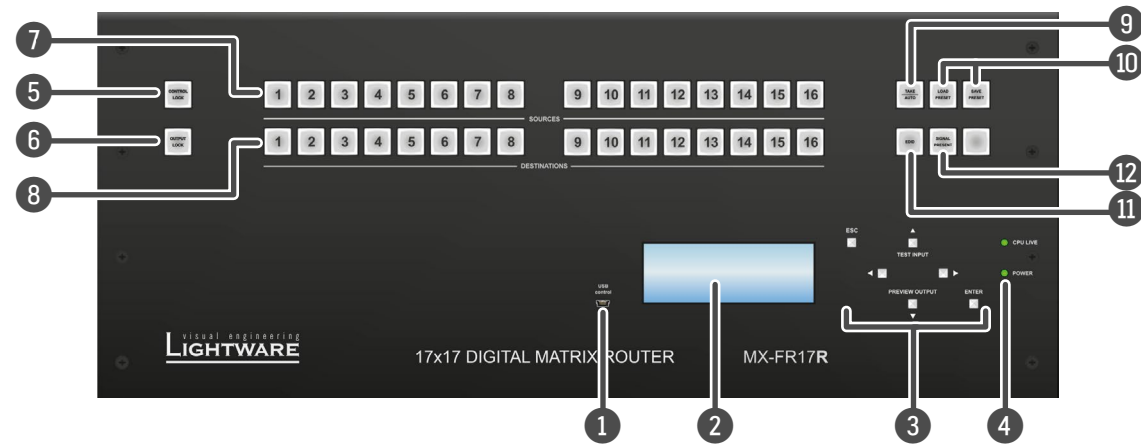

- |  |  |
|--|--|
| <p><b>1 USB control</b> USB connection for Lightware Device Controller software.</p> <p><b>2 Menu display</b> Displays status information and menu operation.</p> <p><b>3 Menu navigation</b> Arrows, escape, and enter buttons for menu navigation.</p> <p><b>4 Status LEDs</b> CPU live LED blinks to indicate normal operation. Power LED lights green when the router is powered on.</p> <p><b>5 Control lock</b> Press long to disable or enable front panel buttons. When red is illuminated, all operations on the front panel are prohibited.</p> <p><b>6 Output lock</b> Locks one (or more) outputs. Inhibits accidental input changing on protected output.</p> <p><b>7 Source buttons</b> Select an input or preset or to view the selected input's state.</p> | <p><b>8 Destination buttons</b> Destination buttons can be used to select an output, or view the selected output's state.</p> <p><b>9 Take / Auto</b> Displays the actual switching mode (TAKE or AUTOTAKE). Long press toggles the switching mode, short press executes switching in TAKE mode.</p> <p><b>10 Preset buttons</b> Load preset: apply a previously saved crosspoint preset from one of the preset memories. Save preset: stores actual crosspoint state, in one of the preset memories.</p> <p><b>11 EDID mode</b> Switches the Menu display to EDID menu allowing EDID switch, EDID save etc.</p> <p><b>12 Signal present</b> Displays live sources and attached sinks on source and destination buttons.</p> |
|--|--|

Rear View

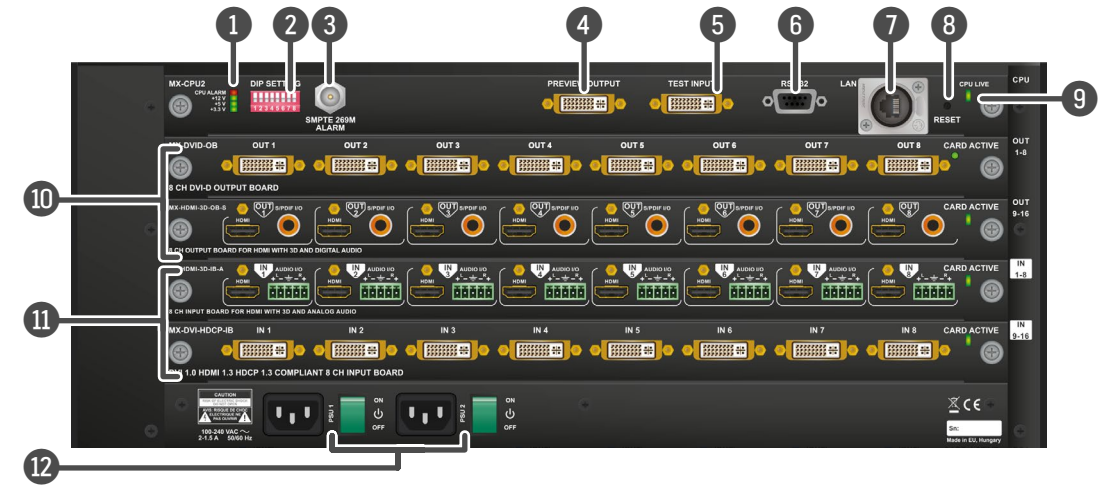

- |   |   |
|---|---|
| <p><b>1 Status LEDs</b> LED indicators for internal DC power voltages and alarm.</p> <p><b>2 DIP settings</b> Special settings can be made with these switches.</p> <p><b>3 Alarm out</b> Standard SMPT 269M alarm output with BNC connector. See the <a href="#">Alarm Output</a> section for more information.</p> <p><b>4 Preview output</b> DVI output connector, which is directly connected to the 17th output. See the <a href="#">DVI Inputs and Outputs</a> and the <a href="#">Test Input and Preview Output</a> sections for more information.</p> <p><b>5 Test input</b> DVI input connector, which can be configured as an alternative for the 17th input. See the <a href="#">DVI Inputs and Outputs</a> and the <a href="#">Test Input and Preview Output</a> sections.</p> <p><b>6 Serial port</b> 9 pole D-SUB female connector for RS-232 serial connection. See the <a href="#">RS-232 Ports</a> section for more information.</p> | <p><b>7 Ethernet port</b> Locking RJ45 connector. Remote control port for connecting the unit to Local Area Network (LAN) and for firmware upgrade. See the <a href="#">Ethernet Ports</a> section for more information.</p> <p><b>8 Reset button</b> Reset button reboots the matrix. This is same as disconnecting from power source, and reconnect again.</p> <p><b>9 CPU live</b> CPU live LED blinks to indicate normal operation.</p> <p><b>10 Output boards</b> Modular output board slots. Connect sink devices to these connectors.</p> <p><b>11 Input boards</b> Modular input board slots. Connect source devices to these connectors.</p> <p><b>12 Power</b> Mains switch and AC power connector of the redundant power supplies.</p> |
|---|---|



### 3.12. MX-FR9

Front View

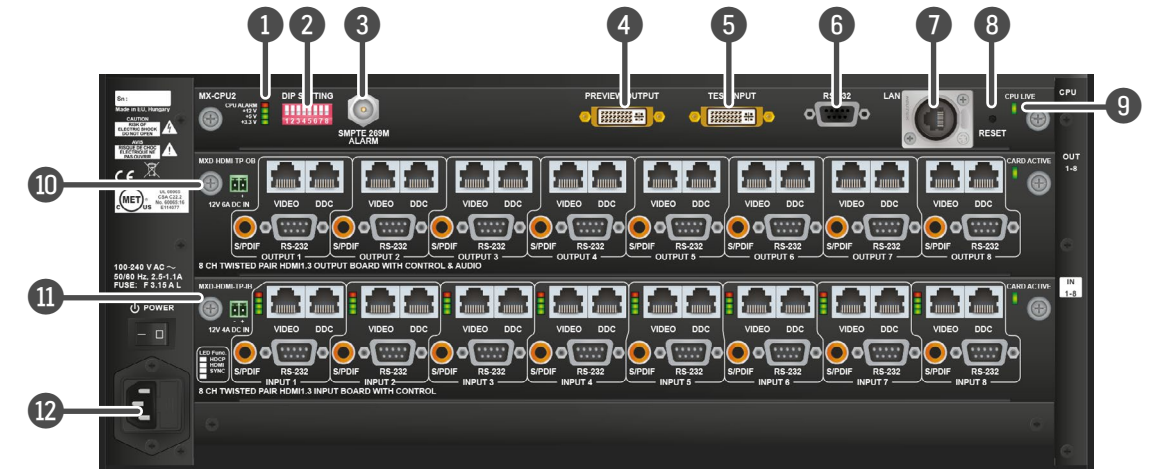
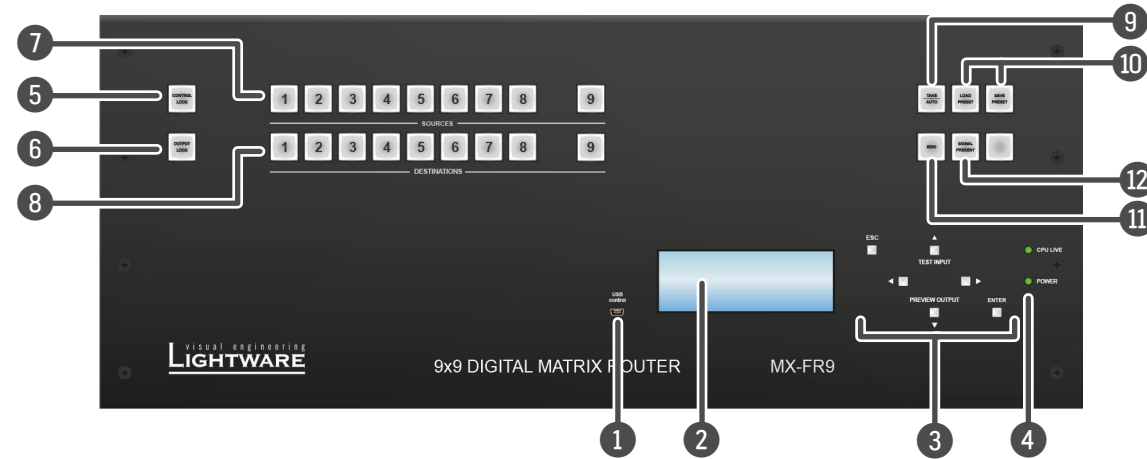

- 1 USB control** USB connection for Lightware Device Controller software.
- 2 Menu display** Displays status information and menu operation.
- 3 Menu navigation** Arrows, escape, and enter buttons for menu navigation.
- 4 Status LEDs** CPU live LED blinks to indicate normal operation. Power LED lights green when the router is powered on.
- 5 Control lock** Press long to disable or enable front panel buttons. When red is illuminated, all operations on front panel are prohibited.
- 6 Output lock** Locks one (or more) outputs. Inhibits accidental input changing on protected output.
- 7 Source buttons** Select an input or preset or to view the selected input's state.

- 8 Destination buttons** Destination buttons can be used to select an output, or view the selected output's state.
- 9 Take / Auto** Displays the actual switching mode (TAKE or AUTOTAKE). Long press toggles the switching mode, short press executes switching in TAKE mode.
- 10 Preset buttons** Load preset: apply a previously saved crosspoint preset from one of the preset memories. Save preset: stores actual crosspoint state, in one of the preset memories.
- 11 EDID mode** Switches the Menu display to EDID menu allowing EDID switch, EDID save etc.
- 12 Signal present** Displays live sources and attached sinks on source and destination buttons.

- 1 Status LEDs** LED indicators for internal DC power voltages and alarm.
- 2 DIP settings** Special settings can be made with these switches.
- 3 Alarm out** Standard SMPTE 269M alarm output with BNC connector. See the [Alarm Output](#) section for more information.
- 4 Preview output** DVI output connector, which is directly connected to the 9th output. See the [DVI Inputs and Outputs](#) and the [Test Input and Preview Output](#) sections for more information.
- 5 Test input** DVI input connector, which can be configured as an alternative for the 9th input. See the [DVI Inputs and Outputs](#) and the [Test Input and Preview Output](#) sections.
- 6 Serial port** 9 pole D-SUB female connector for RS-232 serial connection. See the [RS-232 Ports](#) section for more information.
- 7 Ethernet port** Locking RJ45 connector. Remote control port for connecting the unit to Local Area Network (LAN) and firmware upgrade can be also performed over this interface. See the [Ethernet Ports](#) section for more information.
- 8 Reset button** Reset button reboots the matrix. This is same as disconnecting from power source, and reconnect again.
- 9 CPU live** CPU live LED blinks to indicate normal operation.
- 10 Output boards** Modular output board slots. Connect sink devices to these connectors.
- 11 Input boards** Modular input board slots. Connect source devices to these connectors.
- 12 Power** Mains switch and AC power connector.

### 3.13. MX-FR9R

Front View

#new

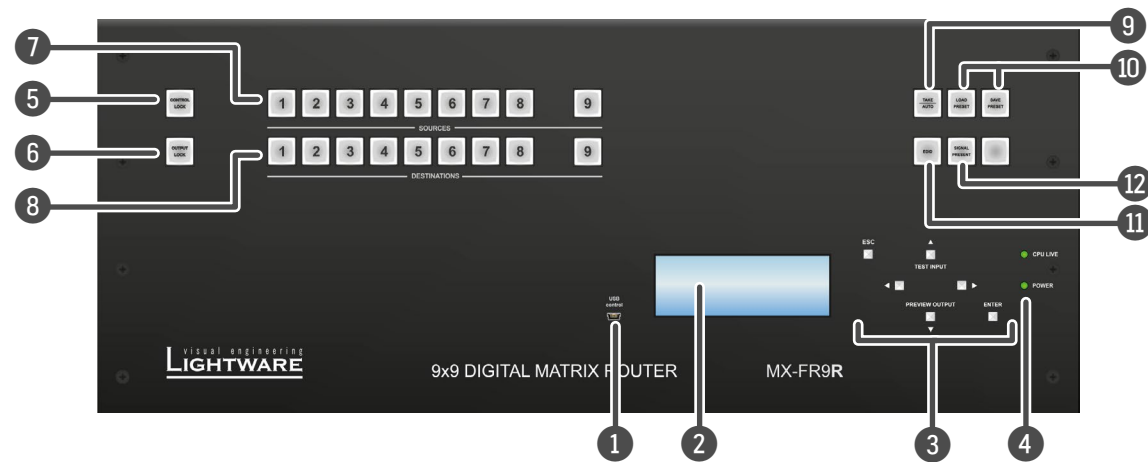

- 1 USB control** USB connection for Lightware Device Controller software.
- 2 Menu display** Displays status information and menu operation.
- 3 Menu navigation** Arrows, escape, and enter buttons for menu navigation.
- 4 Status LEDs** CPU live LED blinks to indicate normal operation. Power LED lights green when the router is powered on.
- 5 Control lock** Press long to disable or enable front panel buttons. When red is illuminated, all operations on front panel are prohibited.
- 6 Output lock** Locks one (or more) outputs. Inhibits accidental input changing on protected output.
- 7 Source buttons** Select an input or preset or to view the selected input's state.
- 8 Destination buttons** Destination buttons can be used to select an output, or view the selected output's state.
- 9 Take / Auto** Displays the actual switching mode (TAKE or AUTOTAKE). Long press toggles the switching mode, short press executes switching in TAKE mode.
- 10 Preset buttons** Load preset: apply a previously saved crosspoint preset from one of the preset memories. Save preset: stores actual crosspoint state, in one of the preset memories.
- 11 EDID mode** Switches the Menu display to EDID menu allowing EDID switch, EDID save etc.
- 12 Signal present** Displays live sources and attached sinks on source and destination buttons.

Rear View

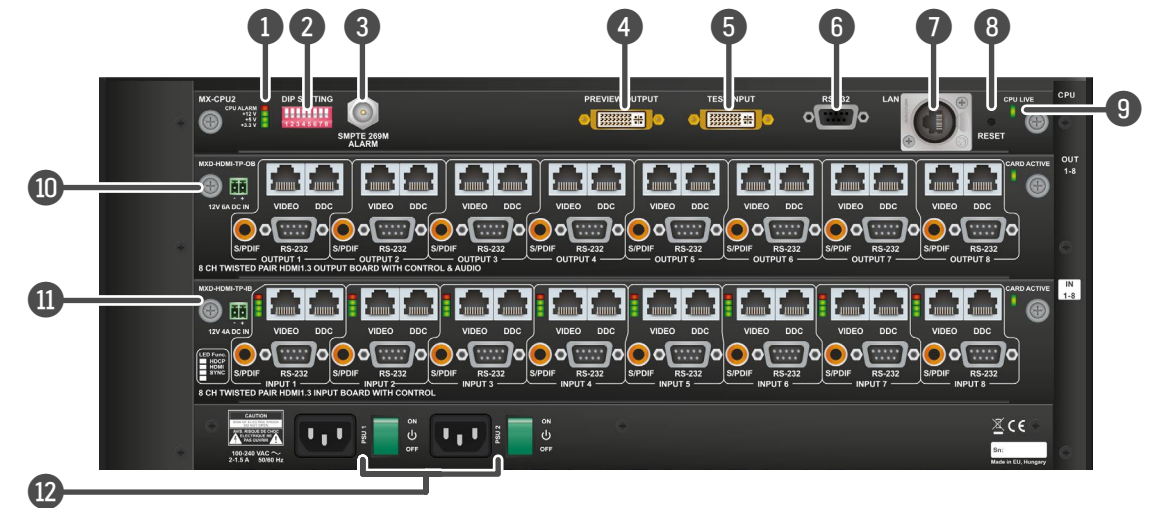

- 1 Status LEDs** LED indicators for internal DC power voltages and alarm.
- 2 DIP settings** Special settings can be made with these switches.
- 3 Alarm out** Standard SMPTE 269M alarm output with BNC connector. See the [Alarm Output](#) section for more information.
- 4 Preview output** DVI output connector, which is directly connected to the 9th output. See the [DVI Inputs and Outputs](#) and the [Test Input and Preview Output](#) sections for more information.
- 5 Test input** DVI input connector, which can be configured as an alternative for the 9th input. See the [DVI Inputs and Outputs](#) and the [Test Input and Preview Output](#) sections.
- 6 Serial port** 9 pole D-SUB female connector for RS-232 serial connection. See the [RS-232 Ports](#) section for more information.
- 7 Ethernet port** Locking RJ45 connector. Remote control port for connecting the unit to Local Area Network (LAN) and firmware upgrade can be also performed over this interface. See the [Ethernet Ports](#) section for more information.
- 8 Reset button** Reset button reboots the matrix. This is same as disconnecting from power source, and reconnect again.
- 9 CPU live** CPU live LED blinks to indicate normal operation.
- 10 Output boards** Modular output board slots. Connect sink devices to these connectors.
- 11 Input boards** Modular input board slots. Connect source devices to these connectors.
- 12 Power** Mains switch and AC power connector of the redundant power supplies.

### 3.14. Electrical Connections

The below sections describe all possible electrical connections of a hybrid router. Please note that the availability of some connection types depend on your modular configuration as different boards have different connectors.

#### 3.14.1. Power Connections

##### Mains Power

Certain frames have redundant power supplies. Every PSU has its own standard IEC power connector and works with 100 to 240 Volts AC, 50 Hz or 60 Hz power source. See the [Powering on](#) section for more information. `#power` `#redundancy`



Frame type	PSU location	Number of PSUs	Output/PSU (max)
MX-FR9	built-in	1	160W
MX-FR9R	built-in	2	350W
MX-FR17	built-in	1	160W
MX-FR17R	built-in	2	350W
MX-FR33L	built-in	1	250W
MX-FR33R	hot swappable	2	160W
MX-FR65R	hot swappable	3	850W
MX-FR80R	hot swappable	3	850W

##### DC IN Connector for TPS Boards

2-pole Phoenix connector is used for 12V DC input for TP and TPS boards and 48V for TPS2 boards. External power adaptor is needed when I/O boards do remote powering TP or TPS extenders.

**WARNING! Use only power adaptors taken from Lightware. Warranty void if damage occurs due to use of a different power source.**

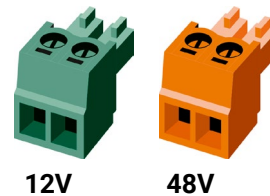

Pin nr.	Signal (TP and TPS boards)	Signal (TPS2 boards)
1	GND	GND
2	12V DC	48V DC

##### Compatible Plug Type

Phoenix® Combicon series (3.5mm pitch), type: MC 1.5/2-ST-3.5.

#### 3.14.2. Video Inputs and Outputs

##### DVI Inputs and Outputs

29 pole DVI-I connectors, however internally connected pins vary by input board types. This way, users can plug in any DVI connector, but keep in mind that analog signals (such as VGA or RGBHV) are processed only on certain boards.



**INFO:** Always use high quality DVI cable for connecting sources and displays.

##### DVI Outputs

29 pole DVI-I connectors for outputs have only digital pins internally connected. This way, users can plug in any DVI connector, but keep in mind that analog signals (such as VGA or RGBHV) are NOT available on outputs.

##### Fiber Cable Powering

DVI outputs are able to supply 500 mA current on DDC +5V output (pin 14 on output connectors) which is sufficient to supply power to hybrid fiber optical DVI cables. Standard DVI outputs usually supply only 55 mA current on +5V output, thus unable to directly power a fiber optical cable.

**INFO:** The matrix router does not check if the connected sink (monitor, projector or other equipment) supports Hotplug or EDID signals but outputs the selected signal immediately after switch command.

##### HDMI Inputs and Outputs

Boards with HDMI ports provide standard 19-pole HDMI connectors for inputs and outputs. Always use high quality HDMI cable for connecting sources and displays.



#### 3.14.3. Audio Inputs and Outputs

##### S/PDIF Digital Audio Input and Output

Certain interface boards have standard RCA receptacles for digital coaxial audio inputs and outputs.

**ATTENTION!** Plugs and sockets on consumer equipment are conventionally color-coded by CEA/CEDIA-863-B (ANSI) to aid correct connections. According to the standard Lightware uses orange colored RCA connectors for S/PDIF signals.



##### Analog Stereo Audio Input and Output

Certain interface boards have standard RCA receptacle for analog stereo audio inputs and outputs. Inputs and outputs work with standard line-in and line-out voltage levels.

**ATTENTION!** Plugs and sockets on consumer equipment are conventionally color-coded by CEA/CEDIA-863-B (ANSI) to aid correct connections. According to the standard Lightware uses red colored RCA connectors for the right channel of analog stereo audio signals and white colored RCA connectors for the left channel of analog stereo audio signals.





### Symmetrical Analog Stereo Audio

5-pole Phoenix connector is used for balanced analog audio (line in/out). Some I/O boards use this connector as a configurable input or output. Always check if this connector is configured as an output or input to prevent connecting two outputs together.

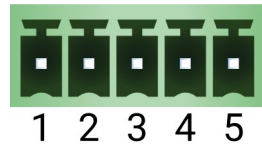

Pin nr.	Signal
1	Left +
2	Left -
3	Ground
4	Right -
5	Right +

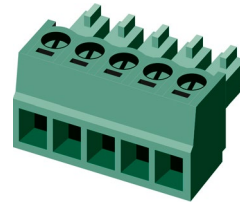

Unbalanced audio signals can be connected as well. For asymmetrical output, connect only + and ground. For asymmetrical input connect + and ground to the source and connect - to the ground.

#### Compatible Plug Type

Phoenix® Combicon series (3.5mm pitch), type: MC 1.5/5-ST-3.5, order number: 1840395.

Please see the short guide about the audio cable wiring in the [Cable Wiring Guide](#) section.

### 3.14.4. RJ45 Connectors and Twisted Pair Cables

#### The Wiring of Twisted Pair Cables

Lightware recommends the termination of TP cables on the basis of TIA/EIA T 568 A or TIA/EIA T 568 B standards.

Pin	TIA/EIA T568 A	Color and name	TIA/EIA T568 B	Color and name
1		white/green stripe		white/orange stripe
2		green solid		orange solid
3		white/orange stripe		white/green stripe
4		blue solid		blue solid
5		white/blue stripe		white/blue stripe
6		orange solid		green solid
7		white/brown stripe		white/brown stripe
8		brown solid		brown solid

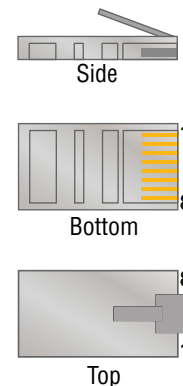

### MX-TP Input and Output Ports

HDMI-TP and DVI-TP interface boards provide standard RJ-45 connectors for VIDEO IN / OUT and DDC IN / OUT. Please note that the DDC connector is not available on MX-DVI-TP-IB and MX-DVI-TP-OB but available on MX-DVI-TP-IB+ and MX-DVI-TP-OB+ boards.

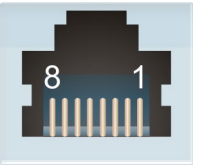

Pin	VIDEO IN/OUT	DDC IN	DDC OUT
1	TMDS Data0+	CEC (no conn.)	CEC (no conn.)
2	TMDS Data0-	Hot Plug Detect (in)	Hot Plug Detect (out)
3	TMDS Clock+	RS-232 RX	RS-232 RX
4	TMDS Data1+	DDC CLK	DDC CLK
5	TMDS Data1-	+12V (out)	+12V (out)
6	TMDS Clock-	RS-232 TX	RS-232 TX
7	TMDS Data2+	DDC SDA	DDC SDA
8	TMDS Data2-	GND	GND

### MX-TPS, MX-TPS2 Inputs and Outputs

MX-TPS boards provide standard RJ-45 connectors for TPS extenders or MX boards.

**ATTENTION!** The same RJ-45 connector is used for Ethernet. Avoid connecting LAN cable to the TPS connectors. If the port of the TPS board was set to AUTO mode, it is able to recognize the LAN cable and swap to Ethernet fallback mode automatically. In this case, the port works as an Ethernet switch, but TPS CAT cable is not allowed to connect to the Ethernet port!

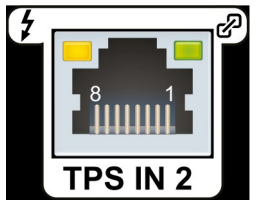

	LED1, Amber ⚡	LED2, Green 🔗
<b>OFF</b>	Remote power is disabled	No TPS link
<b>Blinking 1 flash / sec</b>	N/A	Low power mode, RS-232 and Ethernet
<b>Blinking 2 flashes / sec</b>	N/A	Low power mode, only RS-232
<b>Blinking 6 flashes / sec</b>	N/A	Ethernet fallback mode
<b>ON</b>	Remote power is enabled	TPS link is active

### Ethernet Ports

Lightware matrix routers can be remote controlled through Ethernet as well. The Ethernet port can be connected to a LAN hub, switch or router with a UTP patch cable. If connecting to a computer directly, a cross UTP cable has to be used! The robust Neutrik EtherCON connector ensures reliable connection, however, normal RJ45 connectors can be used as well.



**ATTENTION!** TPS link uses the same RJ-45 connector but TPS CAT cable is not allowed to connect to the Ethernet connector! It seriously damages both devices.

### TPS and TPS2 I/O Boards

The MX-TPS and MX-TPS2 I/O boards also have Ethernet up-link connectors. It is an RJ-45 receptacle with two LEDs and it has the same pin connection as the Neutrik EtherCON.

	LED1, Amber	LED2, Green
<b>OFF</b>	10 Mbps	No link
<b>Blinking</b>	N/A	Activity
<b>ON</b>	100 Mbps	Link is active

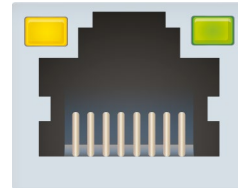

### 3.14.5. Further Connectors

#### RS-232 Ports

MXD-HDMI-TP interface boards provide standard 9-pin female and male D-sub receptacles for serial port pass-through to remote HDMI-TP extenders. The MX-CPU2 boards also contain an RS-232 port which allows to remote control the matrix via industry standard 9-pole D-sub female connector. *#rs-232 #rs232 #serial*

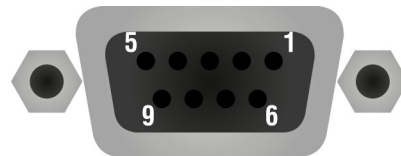

**ATTENTION!** The pinouts of the two connectors are different, which is highlighted in below table.

Pin	RS-232 pinout (I/O boards)	RS-232 pinout (CPU2 board)
1	not connected	not connected
2	<b>RX data receive</b>	<b>TX data transmit</b>
3	<b>TX data transmit</b>	<b>RX data receive</b>
4	DTR (connected to Pin 6)	DTR (connected to Pin 6)
5	GND signal ground (shield)	GND signal ground (shield)
6	DSR (connected to Pin 4)	DSR (connected to Pin 4)
7	RTS (connected to Pin 8)	RTS (connected to Pin 8)
8	CTS (connected to Pin 7)	CTS (connected to Pin 7)
9	not connected	not connected

### Alarm Output

BNC output connector for SMPTE 269M alarm signaling. The router handles different error levels. Only the three highest level errors trigger the alarm output and the CPU alarm LED, see more information in the [Error Handling](#) section.

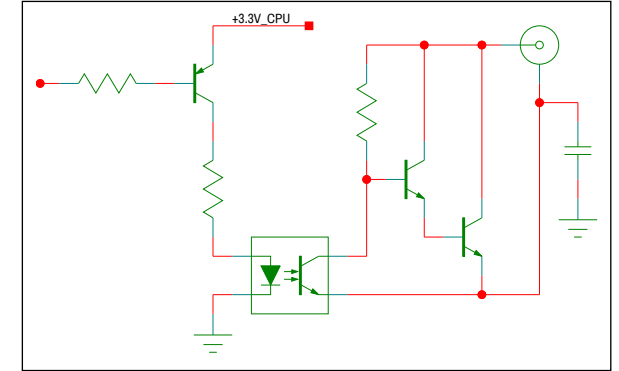
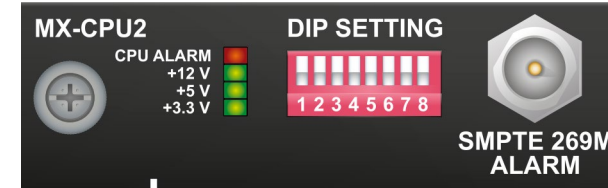

### 3.15. Input Boards



**MX-DVID-IB**



**MX-DVI-4K-IB**



**MX-DVI-TP-IB**

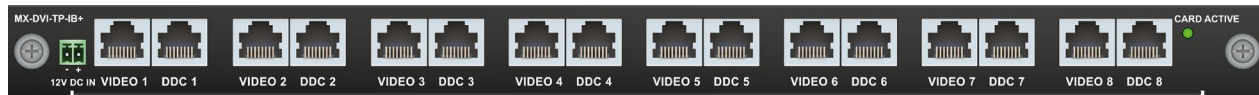

**MX-DVI-TP-IB+**



**MX-DVI-OPT-IB-LC**



**MX-DVI-OPT-IB-ST**

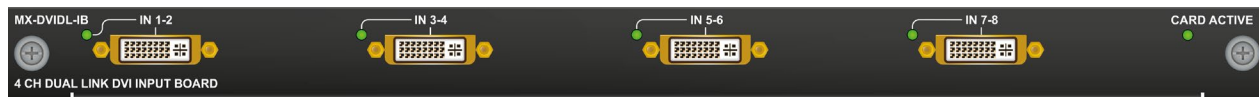

**MX-DVIDL-IB**

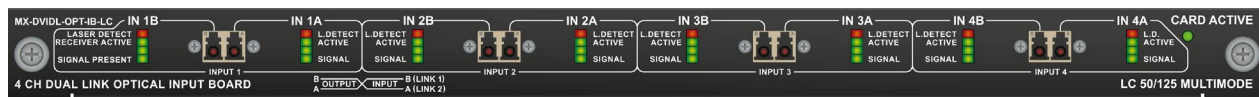

**MX-DVIDL-OPT-IB-LC**

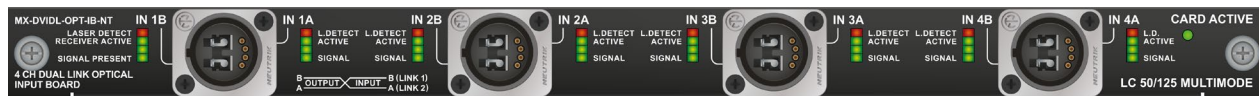

**MX-DVIDL-OPT-IB-NT**

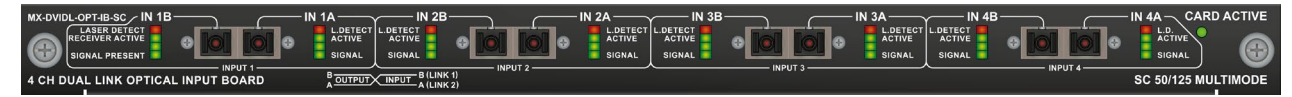

**MX-DVIDL-OPT-IB-SC**



**MX-DVI-HDCP-IB**



**MX-DVII-HDCP-IB**

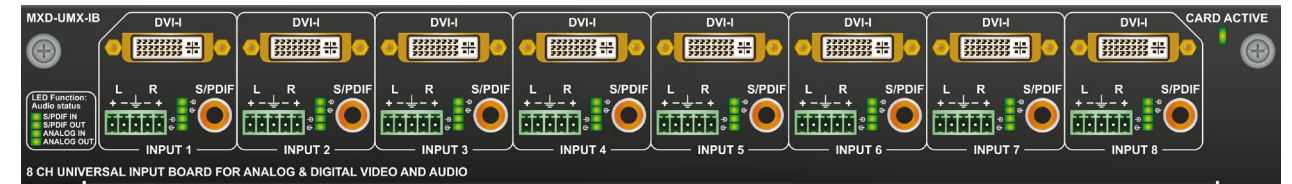

**MXD-UMX-IB**



**MX-HDMI-IB**

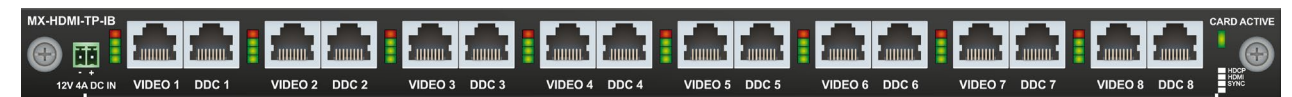

**MX-HDMI-TP-IB**

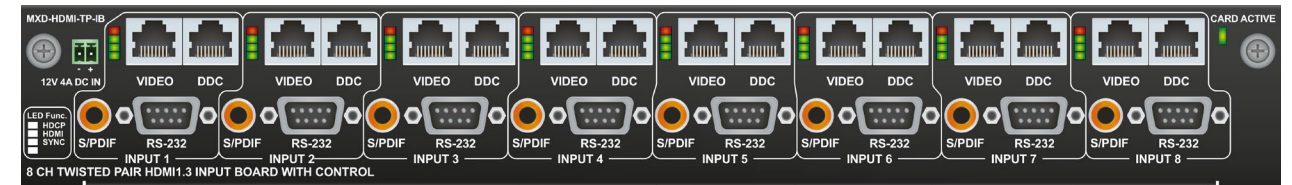

**MXD-HDMI-TP-IB**

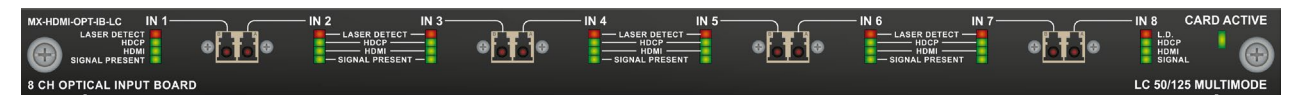

**MX-HDMI-OPT-IB-LC**



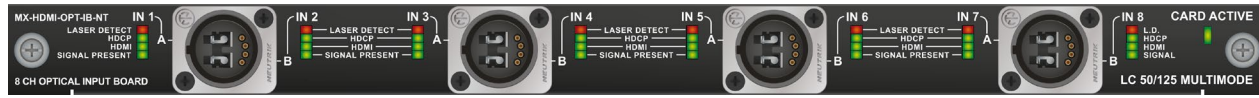

**MX-HDMI-OPT-IB-NT**

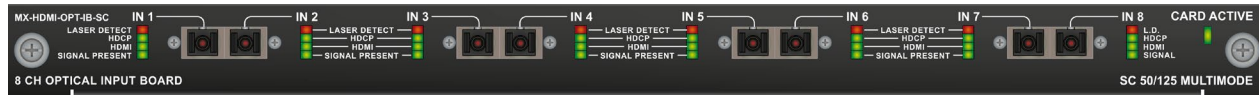

**MX-HDMI-OPT-IB-SC**



**MX-3GSDI-IB**

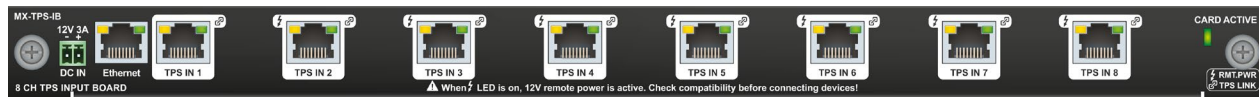

**MX-TPS-IB**



**MX-TPS-IB-A**



**MX-TPS-IB-S**

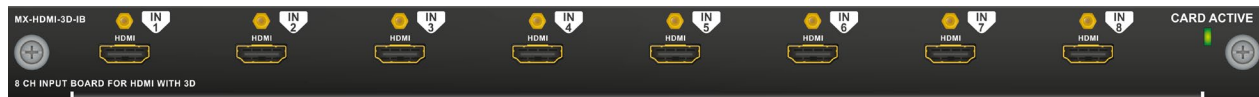

**MX-HDMI-3D-IB**



**MX-HDMI-3D-IB-A**



**MX-HDMI-3D-IB-S**

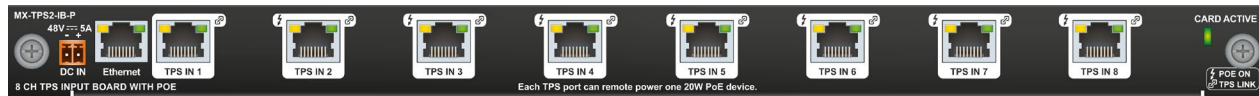

**MX-TPS2-IB-P**

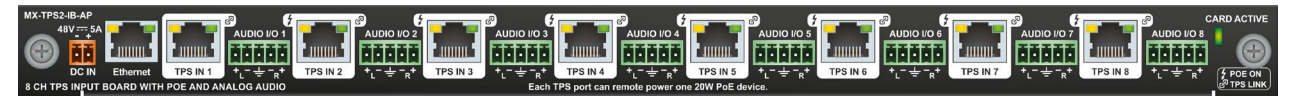

**MX-TPS2-IB-AP**



**MX-TPS2-IB-SP**



**MX-4TPS2-4HDMI-IB**

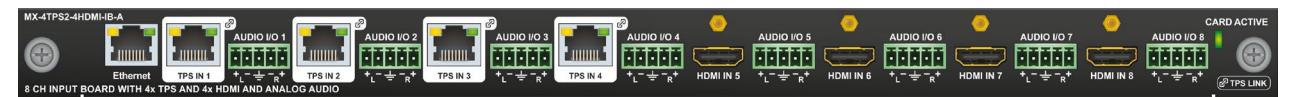

**MX-4TPS2-4HDMI-IB-A**



**MX-4TPS2-4HDMI-IB-S**

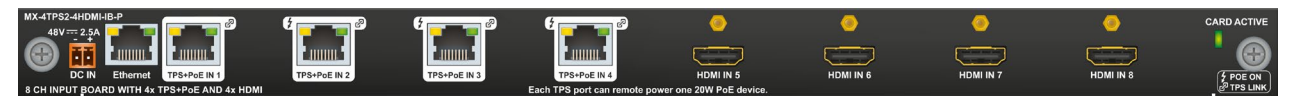

**MX-4TPS2-4HDMI-IB-P**

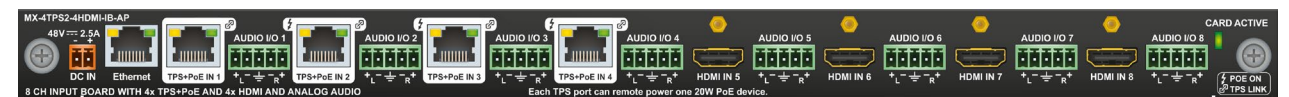

**MX-4TPS2-4HDMI-IB-AP**



**MX-4TPS2-4HDMI-IB-SP**



### 3.16. Output Boards



**MX-DVID-OB**



**MX-DVI-4K-OB**



**MX-DVI-TP-OB**

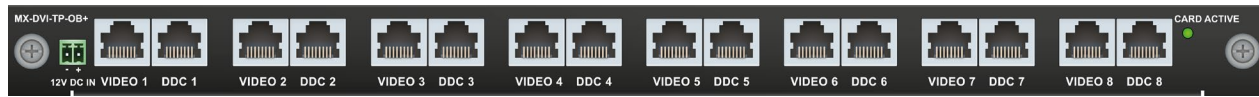

**MX-DVI-TP-OB+**



**MX-DVI-OPT-OB-LC**



**MX-DVI-OPT-OB-SC**



**MX-DVI-OPT-OB-ST**



**MX-DVI-OPT-OB-R-LC**



**MX-DVI-OPT-OB-R-NT**



**MX-DVI-OPT-OB-R-SC**



**MX-DVI-OPT-OB-R-ST**

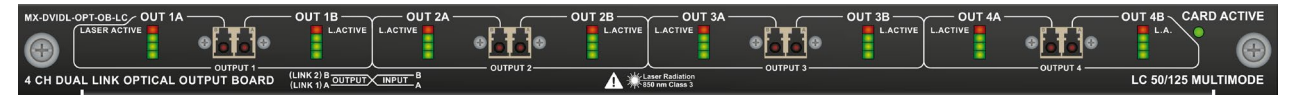

**MX-DVIDL-OPT-OB-LC**



**MX-DVIDL-OPT-OB-NT**



**MX-DVIDL-OB**

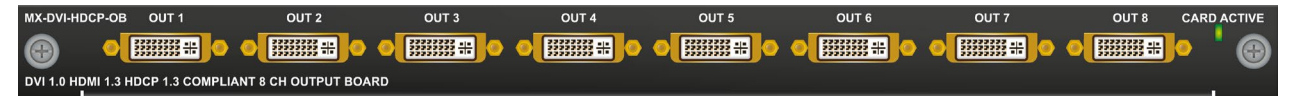

**MX-DVI-HDCP-OB**



**MX-HDMI-OB**

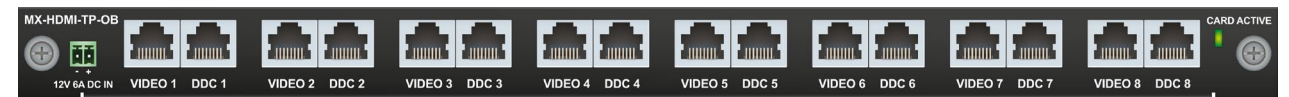

**MX-HDMI-TP-OB**

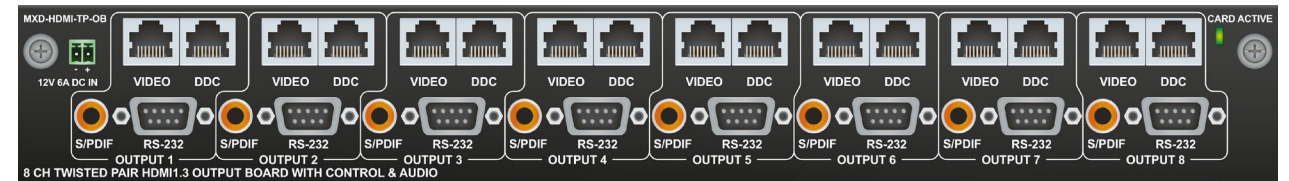

**MXD-HDMI-TP-OB**



**MX-HDMI-OPT-OB-LC**

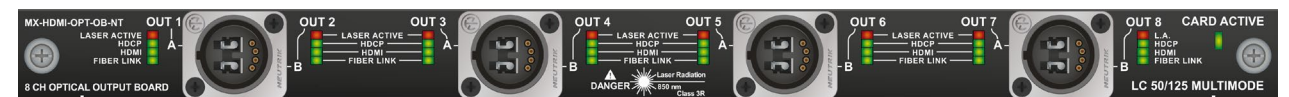

**MX-HDMI-OPT-OB-NT**





**MX-HDMI-OPT-OB-SC**

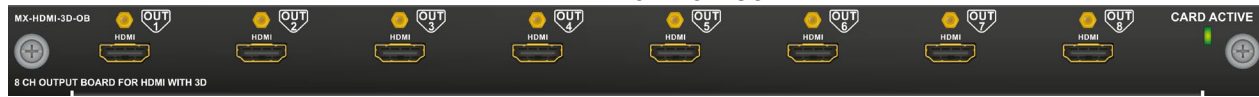

**MX-HDMI-3D-OB**

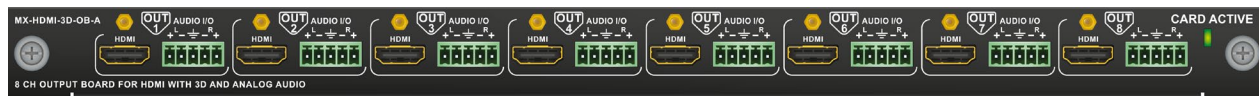

**MX-HDMI-3D-OB-A**



**MX-HDMI-3D-OB-S**

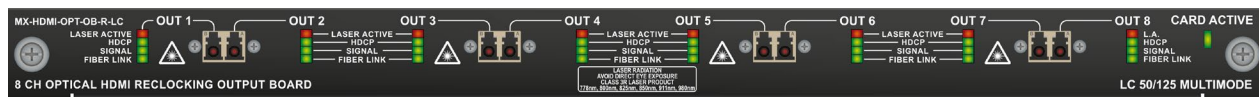

**MX-HDMI-OPT-OB-R-LC**

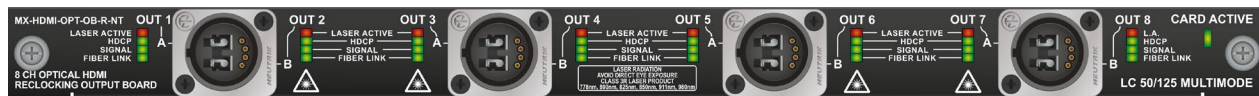

**MX-HDMI-OPT-OB-R-NT**

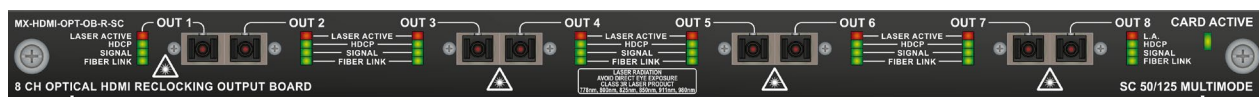

**MX-HDMI-OPT-OB-R-SC**

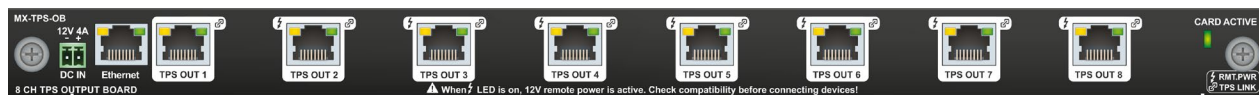

**MX-TPS-OB**

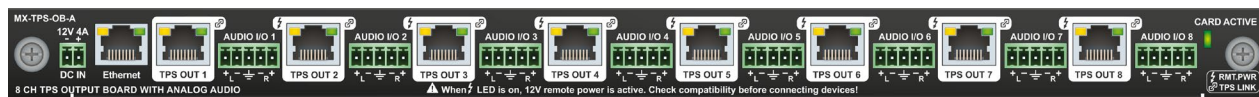

**MX-TPS-OB-A**



**MX-TPS-OB-S**

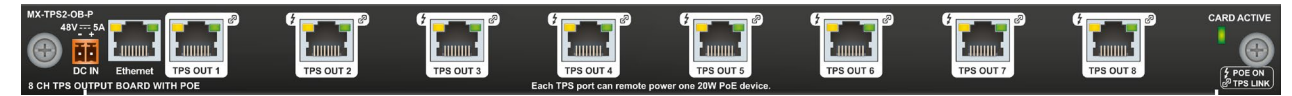

**MX-TPS2-OB-P**



**MX-TPS2-OB-AP**



**MX-TPS2-OB-SP**

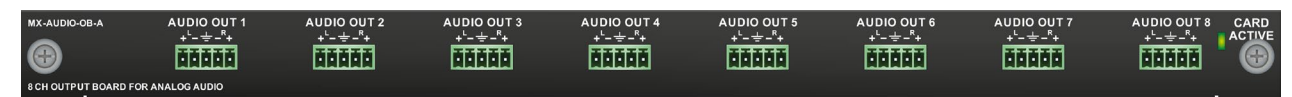

**MX-AUDIO-OB-A**

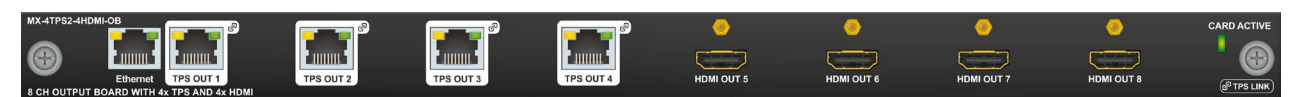

**MX-4TPS2-4HDMI-OB**



**MX-4TPS2-4HDMI-OB-A**



**MX-4TPS2-4HDMI-OB-S**



**MX-4TPS2-4HDMI-OB-P**

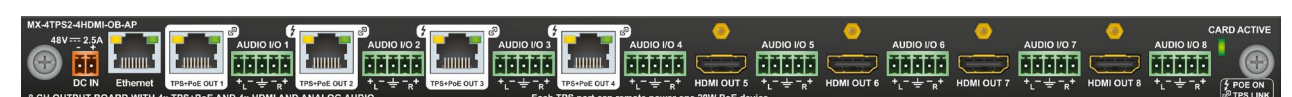

**MX-4TPS2-4HDMI-OB-AP**



**MX-4TPS2-4HDMI-OB-SP**

# 4

## Operation

This chapter is about the powering and operating of the device describing the functions which are available by the front/rear controls:

- ▶ [POWERING ON](#)
- ▶ [THE REMOTE POWER FEATURE OF MX-TPS BOARDS](#)
- ▶ [THE REMOTE POWER FEATURE OF MX-TPS2 BOARDS](#)
- ▶ [BASIC CONTROL PANEL OPERATIONS](#)
- ▶ [THE EDID MEMORY OF A MATRIX](#)
- ▶ [AUDIO OPTIONS](#)
- ▶ [TPS LINK MODES](#)
- ▶ [ABOUT THE ETHERNET \(TPS AND TPS2 BOARDS\)](#)
- ▶ [LCD CONTROL PANEL OPERATION](#)
- ▶ [REMOTE OPERATION](#)
- ▶ [ERROR HANDLING](#)

### 4.1. Powering on

Connect the power cords to the power supply units' IEC standard power input connector. After switching the mains switch to the 'I' position the router starts up. If the mains switch is not available or it was in the 'I' position, then the matrix starts up immediately when the power cord is connected to the AC source.

During the initial self-test and loading of the latest settings "Booting..." appears on the LCD screen. After the self-test, the router reloads its last configuration and it is ready to use. In the case of a hardware failure, an error message is displayed.

INFO: After switching ON, the router reloads the latest settings that were used before it was turned off. The router has an internal emergency memory that stores all current settings and tie configurations. This memory is independent from presets and invisible for the user. This built-in feature helps the system to be ready immediately in the case of a power failure or accidental power down.

#### 4.1.1. Redundant Power Supplies

##### MX-FR9R and MX-FR17R *#new*

These models contain two internal PSUs which are hot swappable but not replacable. If any problem occurs with a PSU the other unit can supply the frame.



##### Replacable Redundant PSU Types

MX-FR33R, MX-FR65R and MX-FR80R frames have hot pluggable, redundant power supplies. Power supply units (PSU) can be dismantled or installed during operation. Depending on the router's configuration (number and type of I/O boards) one or two PSUs are needed to operate. The extra PSU makes the system redundant. Please consult Lightware support about your system configuration to ensure redundancy.

If more than one PSU is needed for supplying the matrix, please make sure that the second PSU gets power no more than 10 seconds after the first one is plugged in to prevent overload on the first PSU.

If one PSU is enough to supply the whole matrix, then the other one(s) can be left unplugged.

INFO: The type of the PSU in the MX-FR33R frame is MX-PSU-350 while the PSU in the MX-FR65R and MX-FR80R frames is FNP850-12RG.

The following redundant Power Supply Units are available in the matrix frames:

##### PSU for MX-FR33R

Two types of PSUs exist for MX-FR33R frames. Both can supply the frame, but the two units are not interchangeable with each other.

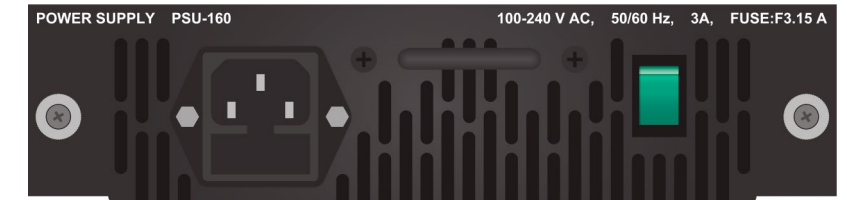

**PSU-160 (phased out product)**

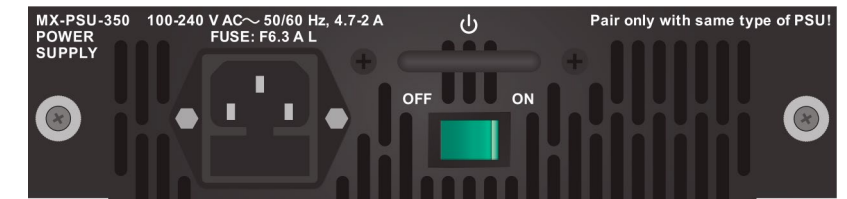

**MX-PSU-350 (available for order)**

**WARNING! Pay attention to install the same type of PSUs in a matrix!**

##### PSU for MX-FR80R and MX-FR65R

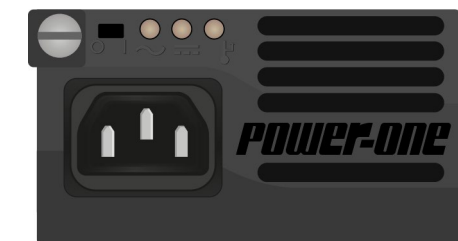

**FNP850-12RG**

*#power*

*#redundancy*



### 4.2. The Remote Power Feature of MX-TPS Boards

**WARNING! Incorrect configuration may cause damage to the devices. Do not connect TPS-TX/RX90 extenders to the TPS boards as the devices will be damaged.** #new

MX-TPS boards can be configured to remotely power the connected TPS-TX/RX95 or TX/RX96 extenders. The following boards support this feature:

- MX-TPS-IB, -A, -S
- MX-TPS-OB, -A, -S

To use remote powering you will need the followings:

- PSU-12VP (part no: 91340007) external PSU,
- Jumper pack (part no: 91340008).

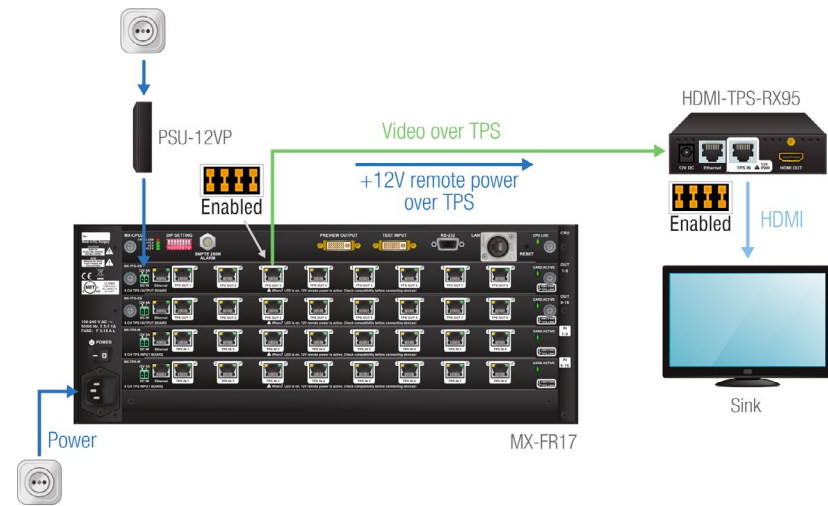

#### Important instructions

- When remote power is active the ports are NOT HDBaseT™ compliant, in this case, do not connect any third party device.
- Below jumper setting is compatible only with Lightware TPS-TX/RX95 and TPS-TX/RX96 devices.

#### Cable length

Please note, that the distances are 20% shorter if the remote powering is used in the case of AWG 26 CAT cables. The remote powering can be enabled or disabled for each port separately. Some of the ports can have remote powering enabled for Lightware extenders. While other ports can have remote powering disabled and be used with HDBaseT™ compliant devices.

### Settings in the TPS Board

Place the jumper block to the indicated position in the board at all desired TPS ports:

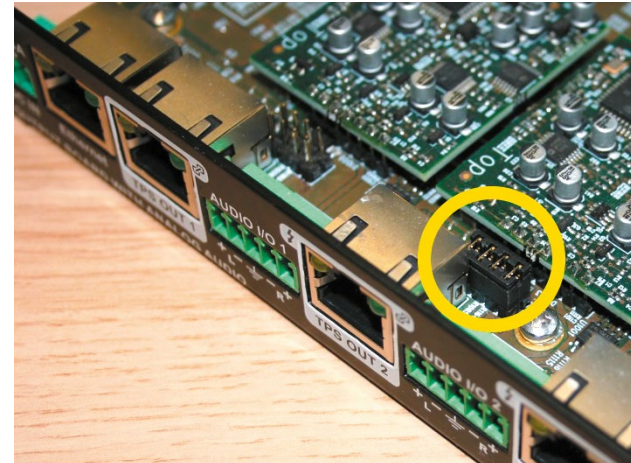

### Setting in the Extender

When TPS-TX/RX95 device is powered over the MX-TPS board, set the jumper block in the extender to the right position:

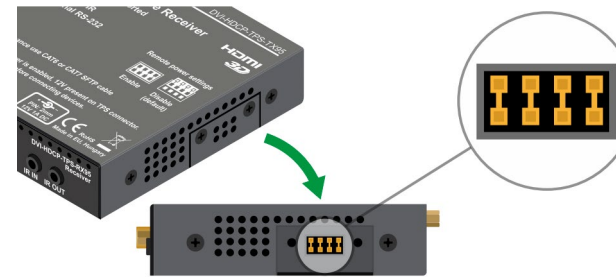

### 4.3. The Remote Power Feature of MX-TPS2 Boards

Remote powering option for a connected PoE-compatible TPS extender is available in the case of MX-TPS2 boards.

PoE-compatible TPS2 Boards:

- MX-TPS2-IB-P, -AP, -SP
- MX-4TPS2-4HDMI-IB-P, -AP, -SP
- MX-TPS2-OB-P, -AP, -SP
- MX-4TPS2-4HDMI-OB-P, -AP, -SP

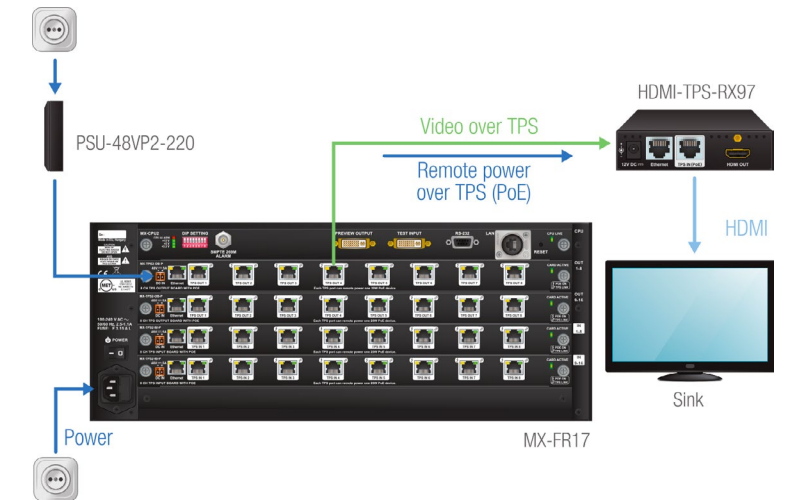

To use the function you will need the external PSU supplied with the board.

**WARNING! TPS-TX/RX90 and TPS-TX/RX95 devices do not comply with the PoE standard and cannot be powered this way as the devices may get damaged.**

TIPS AND TRICKS: If a connected TPS device needs PoE-compatible remote powering but the board is not PoE-compatible, just install the TPS-PI-1P1 power injector device in the TPS chain.

## 4.4. Basic Control Panel Operations

### 4.4.1. CONTROL LOCK

DEFINITION: The **Control Lock** means to disable the front panel buttons.



While the front panel buttons are disabled the RS-232 / RS-422, USB and Ethernet control is still enabled. If the button is not illuminated, front panel button operations are enabled. If it illuminates red continuously, front panel operations are inhibited (including LCD menu).

Press and hold the **Control lock** button for 3 seconds to toggle the control lock state. `#button` `#controllock`

### 4.4.2. Take / Autotake Modes

The router has two different switching modes: **Take** and **Autotake**. If the **Take / Auto** button is unlit, **Take** mode is active. When the **Take / Auto** button continuously lights green, **Autotake** mode is selected.

Press and hold the **Take** button for three seconds to toggle between **Take** and **Autotake** modes.

#### Take Mode

DEFINITION: The **Take** mode allows the user to connect or disconnect multiple outputs to an input at once but the layout must be confirmed (executed) by the Take button as a final step.



The commands are only realized when the **Take** button is pressed. If no button is pressed for two seconds, all preselected actions (which were not realized with the pressing **Take**) will be ignored, and the router returns to its idle state.

#### Autotake Mode

DEFINITION: The **Autotake** mode means the switching actions are executed immediately (without user confirmation).



The switching occurs immediately upon pressing one of the input selector buttons. This mode is useful when time delay is not allowed between multiple switching.

### 4.4.3. Source and Destination Buttons

Normal I/O ports have dedicated buttons on the front panel. These buttons are labeled with numbers and have a back light to indicate active or selected ports. These are referred as Source and Destination buttons.

However, the MX-CPU2 has a Test input and a Preview output port which does not have dedicated buttons with back light.

#### Test Input and Preview Output

To access the Test input and Preview output ports from the front panel, the **up** ▲ and **down** ▼ buttons can be used which are next to the front panel LCD.

```
•Switch In17 Out17>>
```

```
Press UP:
Test input [ ]
Press DOWN:
Preview output [*]
```

To use this function navigate to the 'Switch In## Out##' menu (## can be 17 or 33 depending on the frame type). If any of the source or destination buttons are pressed, this menu activates for three seconds to give quick access to the additional I/O ports. An asterisk indicates if the port is selected just like the backlight LEDs for normal I/O ports.

See the [Test Input and Preview Output Ports](#) section for more information.

### 4.4.4. Viewing Crosspoint State

The user can check the current switching status on the front panel using front panel buttons. This status view feature is slightly different in **Take** or **Autotake** modes because of different switching philosophy of the two modes. `#crosspoint` `#switch`

INFO: A status view occurs whenever the router has to be switched. After entering the view state, the user can change the routing configuration. Viewing and switching can be done after each other, or if nothing is pressed for three seconds, the router returns to idle state.

#### View Current State in Take Mode

If all source and destination buttons and **Take** button are dark (the unit is in **Take** mode, and no input was selected in last 3 seconds), the user can verify both input and output connections. This informative display will remain for 3 seconds, and then all button lamps go out. In **Take** mode no accidental change can be done unless **Take** button is pressed.

For viewing input connections, press and release a source button. Now the selected source button and all destination buttons will light up which are currently connected to the selected source.



For viewing output connections, press and release a destination button. Now the source button which is connected to the selected destination will light up. If no source button is lighting, the selected destination is in muted state.



#### View Current State in Autotake Mode

In **Autotake** mode only states of destinations can be viewed.

Press and release the required destination button. Now the source button which is connected to the selected destination will light up. If no source button is lighting, the selected destination is muted or disconnected. By pressing another destination button, the state of that destination can be seen.



**ATTENTION!** Be careful, as if a source button is pressed in **AUTOTAKE** mode, it is immediately connected to the last selected destination.

INFO: Muting or disconnecting an output cannot be done in **Autotake** mode.

### 4.4.5. Switching

#### Changing Connections in TAKE Mode

**Step 1.** Press and release the desired **source** button. The pressed source button and all destination buttons which are currently connected to this source will light up. This is an informative display about the current status of the selected input (view only). *#crosspoint #switch #takemode*



**Step 2.** Press and release the desired **destination button(s)** which has to be connected to the selected source. The preselected destination button(s) start(s) blinking.



**Step 3.** Press and release the **Take** button to execute switching. Now the selected input is switched to the selected output or to the multiple outputs.

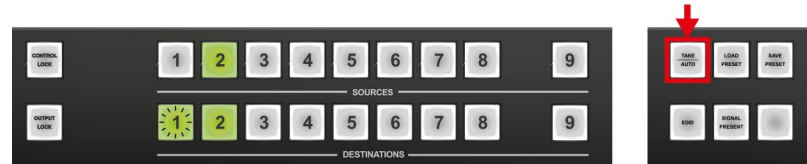

**ATTENTION!** A source button can be pressed twice to preselect all outputs. Outputs which are connected to the pressed input light up and all other outputs start to blink. Some outputs can be unselected if needed, and then pressing **Take** executes the switching.

**INFO:** **Test input** and **Preview output** ports can be accessed with **up** ▲ and **down** ▼ buttons when the LCD shows their status. An asterisk on the LCD indicates if the port is selected just like the back light for other I/O ports.

**INFO:** If the pressed destination is locked then it could not be selected. This is indicated by a short flash of the **Output lock** when a locked destination is pressed.

#### Disconnecting or Muting in Take Mode

**Step 1.** Press and release the selected **source** button.

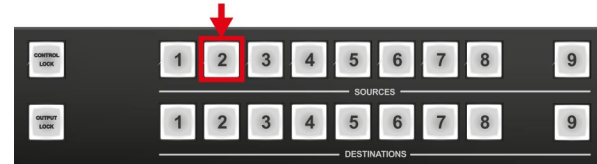

The pressed source button and all destination buttons which are currently connected to this source will light up.

**Step 2.** Press and release the desired green lighting **destination** button. The pressed destination or multiple destinations will turn dark.



**Step 3.** Press and release **Take** button to execute disconnection.

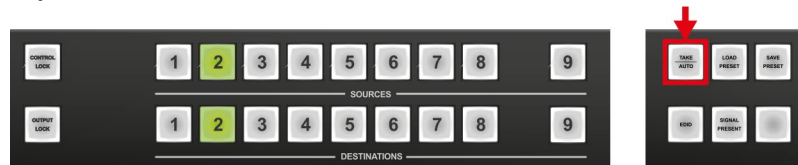

**INFO:** Deselected destinations are disconnected from any source, thus output devices will display black image or **no signal** message, or automatically will turn off.

*#mute*

#### Creating a Connection in Autotake Mode

**Step 1.** Press and release the desired **destination** button.



The pressed destination button and the actually connected source button light up green. If no source is connected (the output is muted) no source button will light up.

**Step 2.** Press and release the desired **source** button.



Switching is executed immediately. Switching between sources to the selected destination can be done directly.

**INFO:** The 'Switch In## Out##' menu activates automatically when entering **Autotake** mode to give quick access to the Test input and Preview output ports.

**INFO:** **Test input** and **Preview output** ports can be accessed with **up** ▲ and **down** ▼ buttons when the LCD shows their status. An asterisk on the LCD indicates if the port is selected just like the back light for other I/O ports.

#### Disconnecting or Muting in AUTOTAKE Mode

To prevent accidental muting this action is inhibited (disabled) in **Autotake** mode. Pressing a **source** button twice would cause accidental disconnecting.



### 4.4.6. Switching Operations Flowchart

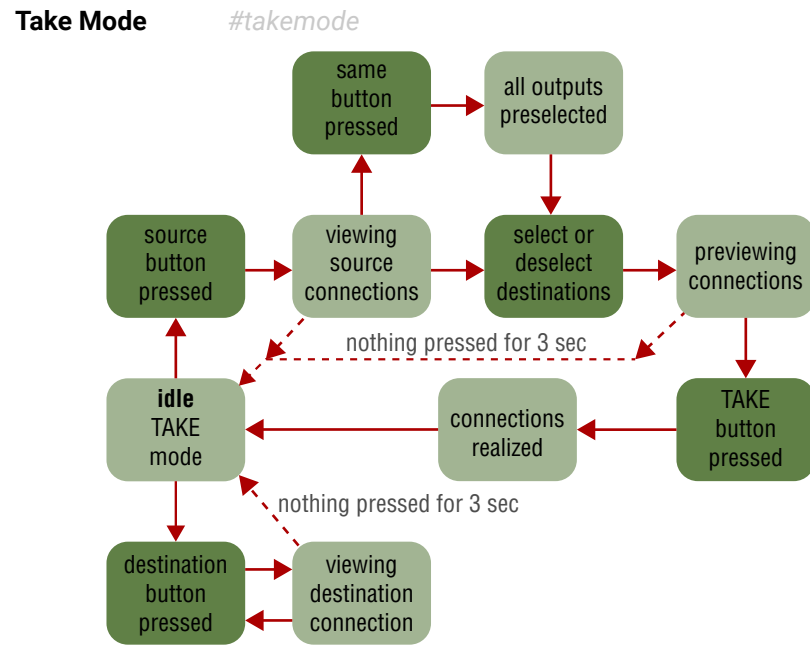

### Autotake Mode

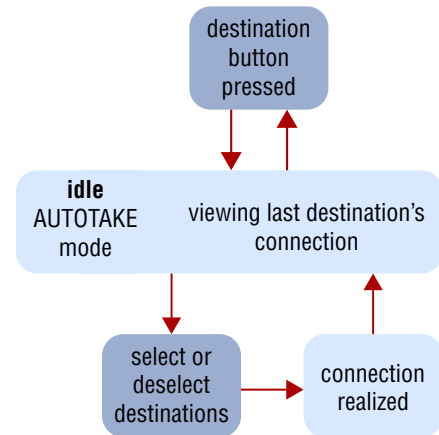

### 4.4.7. Preset Operations

**DEFINITION:** A **preset** stores a configuration regarding all input connections and mute state for all outputs. *#preset*

**INFO:** All Lightware matrix routers have 32 user programmable presets. All presets are stored in a non-volatile memory; the router keeps presets even in the case of a power down. Memory numbers are assigned to source buttons 1 to 32. If the frame has fewer buttons, the higher numbered presets are accessible only through software control.

#### Saving a Preset in Take Mode

- Step 1. Create the desired connections which have to be saved.
- Step 2. Press and release the **Save preset** button.



- Step 3. Press and release a **source** button according to the desired memory address (source 1 to 32).

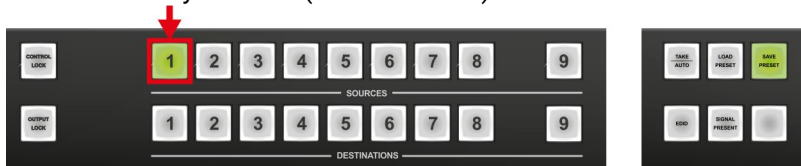

- Step 4. Press and release the **Take** button.



Now the current configuration is stored in the selected memory.

**ATTENTION!** Preset save action always stores the current configuration for all outputs including mute state, but ignoring lock state.

#### Loading a Preset in Take Mode

- Step 1. Press and release the **Load Preset** button.

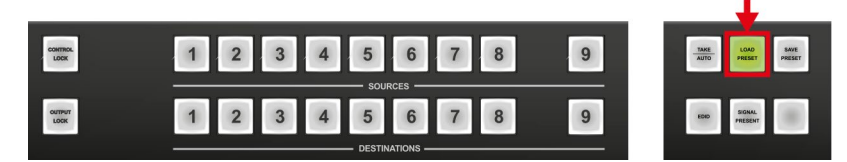

- Step 2. Press and release a **source** button according to the desired memory address (source 1 to 32).



- Step 3. Press and release the **Take** button.



Now the selected preset is loaded.

**ATTENTION!** Loading a preset modifies all output states that are not currently locked.

#### Saving a Preset in Autotake Mode

- Step 1. Create the desired connections which have to be saved.
- Step 2. Press and release **Save Preset** button.



- Step 3. Press and release a **source** button according to the desired memory address (source 1 to 32).



Now the current configuration is stored in the selected memory.

**ATTENTION!** Preset save action always stores the current configuration for all outputs including mute state, but lock state is ignored.



### Loading a Preset in Autotake Mode

**Step 1.** Press and release **Load Preset** button.

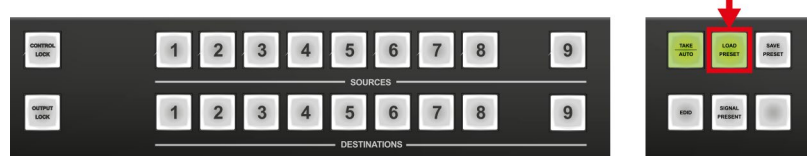

**Step 2.** Press and release a **source** button according to the desired memory address (source 1 to 32).



Now the selected preset is loaded.

**ATTENTION!** Loading a preset modifies all output states that are not currently locked.

### 4.4.8. Output Lock

**DEFINITION:** The **Output lock** means that an input port is locked to an output port and no input change or muting can be executed on that particular output port.



Using Lightware routers it is possible to lock a destination's state. This feature prevents an accidental switching to the locked destination in the case of an important signal. Destinations can be independently locked or unlocked. Locking a destination does not affect other destinations. `#lock` `#outputlock`

### View Locked Outputs in Take Mode

**Step 1.** Press and release the **Output Lock** button.

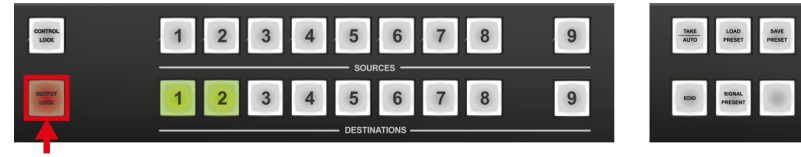

**Step 2.** The **Output Lock** button starts to blink and all the buttons of any locked destinations light up and remain illuminated for three seconds.

### Locking an Output in TAKE Mode

**Step 1.** Press and release the **Output Lock** button.

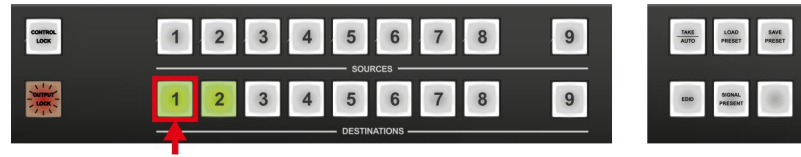

Now the **Output Lock** button starts to blink and the buttons of all the locked **outputs** illuminate green (view state). If no button is pressed for three seconds the router returns to idle state.

**Step 2.** Press the desired **output** buttons.



If an unlit output button is pressed it starts to blink indicating that it is preselected, for output locking.

**Step 3.** Press and release the **Take** button.



The selected destinations are now locked.

### Unlocking an Output in Take Mode

**Step 1.** Press and release the **Output Lock** button.

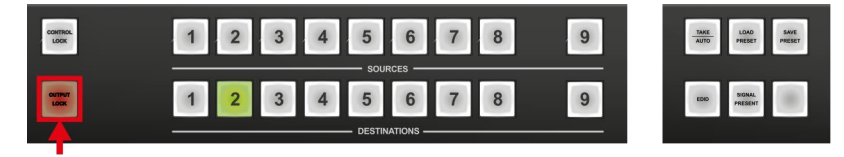

Now the **Output Lock** button starts to blink and all the locked output's buttons illuminate green (view state). If no button is pressed for three seconds, the router returns to idle state.

**Step 2.** If an illuminating **output** button is pressed, it goes off, to indicate that it is preselected for unlocking.

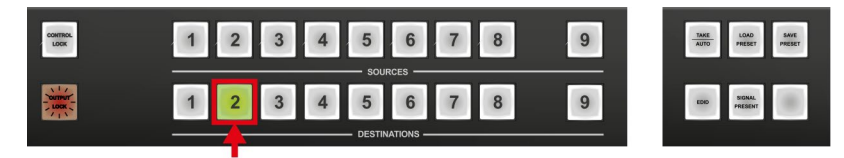

**Step 3.** Press and release the **Take** button.

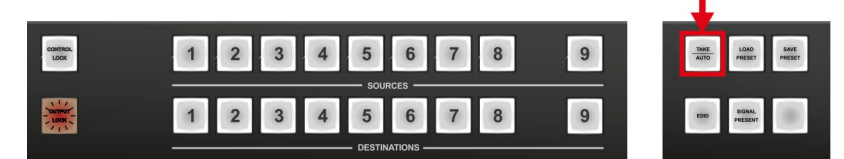

The deselected destinations are now unlocked.

### View Locked Outputs in Autotake Mode

In **Autotake** mode a destination is selected all the time. Therefore the currently selected output and input buttons are illuminated. The **Output Lock** button illuminates regarding the lock state of the current output.

Viewing all locked outputs is not possible in **Autotake** mode, as pressing the **Output Lock** button instantly locks or unlocks the current output.

`#unlock`

**Locking an Output in Autotake Mode**

**Step 1.** Press and release the required **destination** button.

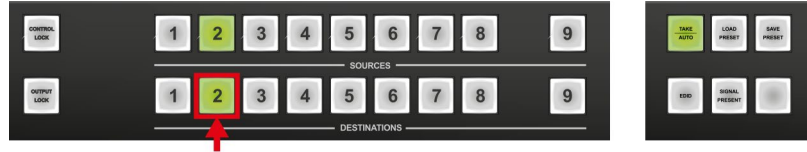

Now the selected destination button and the currently configured source button light up (view mode).

**Step 2.** Press and release the **Output Lock** button.



Now the **Output Lock** button lights up in red, and lock function is activated at once. No source can be changed at the locked destination.

**Unlocking an Output in Autotake Mode**

**Step 1.** Press and release the required **destination** button which was previously locked.



Now the selected destination button and the currently configured **source** button and the **Output Lock** button light up.

**Step 2.** Press and release the **Output Lock** button (deselection).



Now the **Output Lock** button turns off and the port has been unlocked.

#unlock

**4.5. The EDID Memory of a Matrix**

The EDID memory is non-volatile and consists of four blocks, each for a different purpose. These blocks are:

- **Factory preset EDIDs**
- **User saved EDIDs**
- **Dynamic EDIDs** (EDID of last connected sink on a specific output port)
- **Emulated EDIDs** (EDID currently emulated on a specific input port)

EDIDs are numbered from 1 in each block, and they can be referred as the first letter of the block name and the number of the desired EDID. This way F02 refers to the second factory preset EDID and D15 refers to the display device's EDID on output 15.

Dynamic and emulated EDID blocks' size adapts to the frame size. The memory structure is as follows:

- F01..F99 .....Factory Preset EDIDs (not editable)
- U01..U50 .....User programmable memories
- D01..Dxx.....Last attached monitor's EDIDs (outputs)
- E01..Exx .....Emulated EDIDs (inputs)

All EDIDs (including factory preset; user programmable memories; EDID at other inputs; and EDID at outputs) can be switched and emulated at any of the inputs.

**ATTENTION!** The attached monitor's EDID is stored automatically until a new monitor is attached to that particular output. In the case of powering the unit off, the last attached monitor's EDID remains in non-volatile memory even is the monitor is unconnected.

INFO: MX-CPU2 can handle both 128 Byte EDID and 256 Byte extended EDID structures.

**4.5.1. EDID Types**

Most of the factory preset EDIDs include only one resolution. This is to force the connected source to give a signal with the needed resolution. However there are Universal EDIDs as well which allow many resolutions. The factory EDIDs are divided into groups regarding their type. Some EDIDs are supporting DVI only, some support HDMI, and some are for analog VGA signals. Also, there are some EDIDs for Dual Link DVI resolutions. See the list of factory EDIDs in the [Factory EDID List](#) section.

**DVI EDIDs** do not support audio. The Universal DVI EDID indicates support for many PC (VESA) resolutions.

**HDMI EDIDs** support embedded audio. These EDIDs have PCM stereo audio format enabled. To allow other audio formats like Dolby and DTS, special EDIDs have to be used. There are three Universal HDMI EDIDs which include the same resolutions but support different capabilities.

EDID	PCM audio	other audio	deep color
Universal_HDMI_PCM	yes	no	no
Universal_HDMI_ALL	yes	yes	no
Universal_HDMI_DC	yes	yes	yes

**Analog EDIDs** can be used for input ports which have a VGA (RGBHV) source.

**Dual Link DVI EDIDs** do not support audio. Use only for Dual Link ports.

**4.6. Audio Options**

Certain I/O boards have extended audio options thanks for the additional auxiliary audio ports. These ports can be configured as input or output ports. This section is about to present the capabilities of this audio add-on feature. #audio

**Supported Boards**

- MX-TPS-IB-S, -A
- MX-TPS-OB-S, -A
- MX-HDMI-3D-IB-S, -A
- MX-HDMI-3D-OB-S, -A
- MX-TPS2-IB-SP, -AP
- MX-TPS2-OB-SP, -AP
- MX-4TPS2-4HDMI-IB-A, -S

**4.6.1. Legend of the Figures**

**Audio de-embedder:** Audio de-embedder is able to separate the HDMI video and audio.

**Audio embedder:** Audio embedder is able to add an audio stream to an HDMI video which does not contain audio.

**Interface and I/O switcher:** The 'Interface and I/O module' configures the audio port as an input or an output and converts the analog input signals to digital and the digital output signals to analog.

4.6.2. Audio Settings

(A) No Audio

The embedded audio of the HDMI video is eliminated and the video goes towards the HDMI crosspoint (in the case of input cards) or the output port (in the case of output card) without the audio channel.

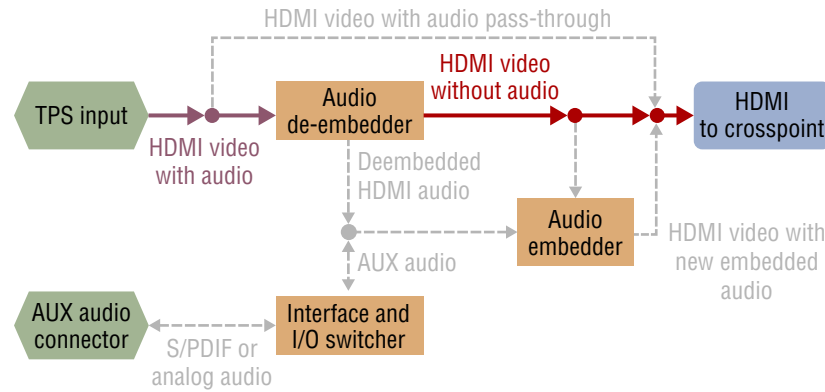

Input Side

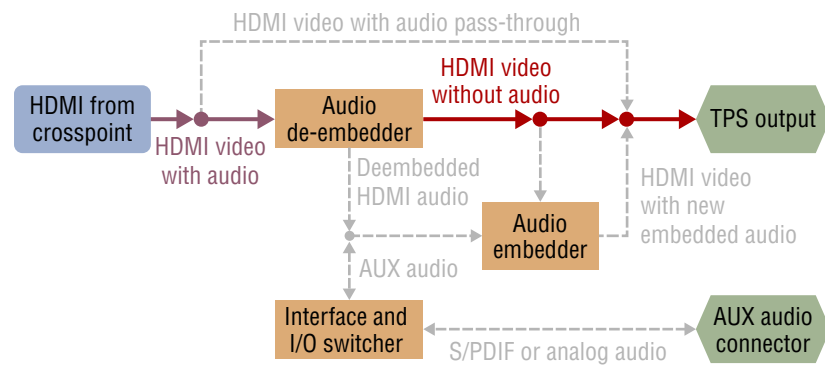

Output Side

(B) HDMI Audio Pass-through

The HDMI video (with embedded audio) goes towards the HDMI crosspoint (in the case of input cards) or the output port (in the case of output card) without any modification.

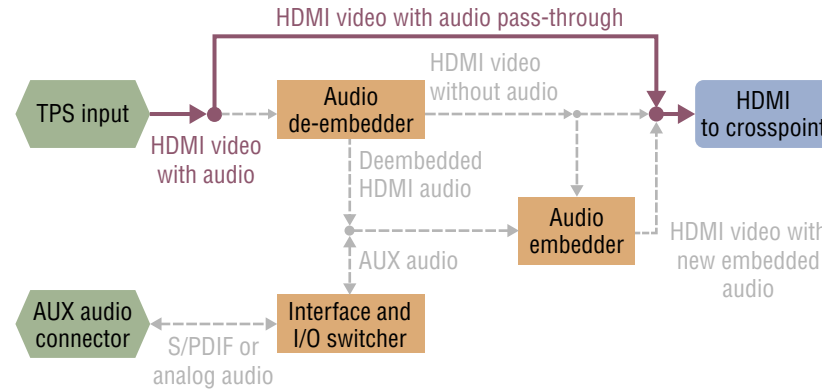

Input Side

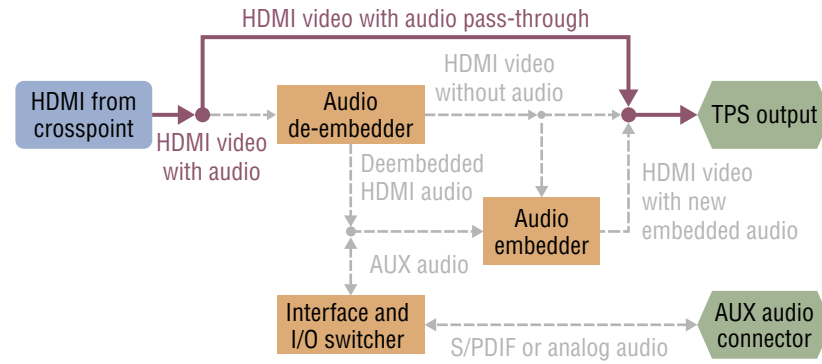

Output Side

(C) Embed From Aux Audio

It means the original embedded audio is swapped for the auxiliary audio stream and the video – with the embedded auxiliary audio – moves on. #analogaudio

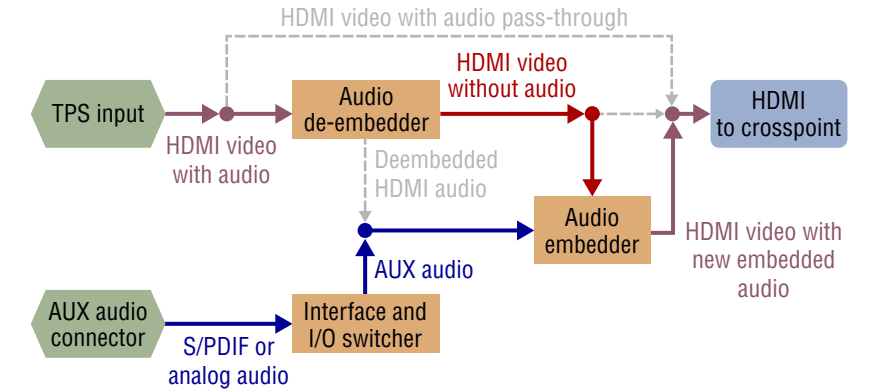

Input Side

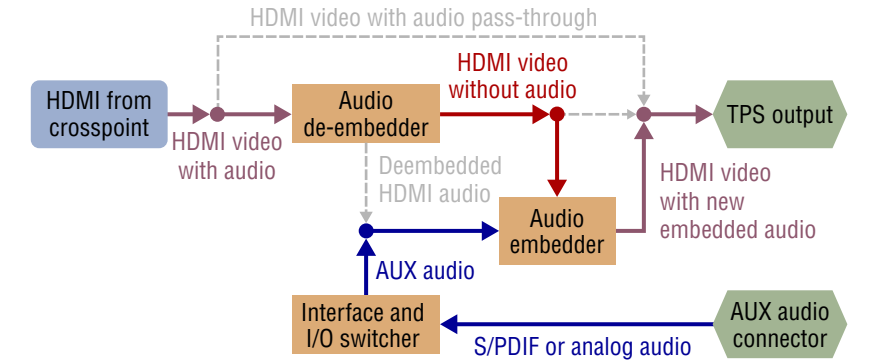

Output Side

**(D) De-embed to Aux Audio**

The embedded audio of the HDMI video is eliminated and the video goes towards the HDMI crosspoint (in the case of input cards) or the output port (in the case of output card) without the audio channel. The original HDMI audio channel appears on the auxiliary port.

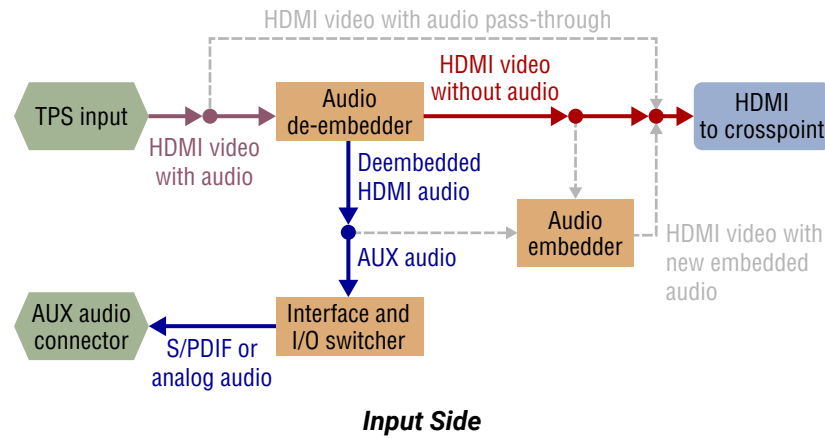

Input Side

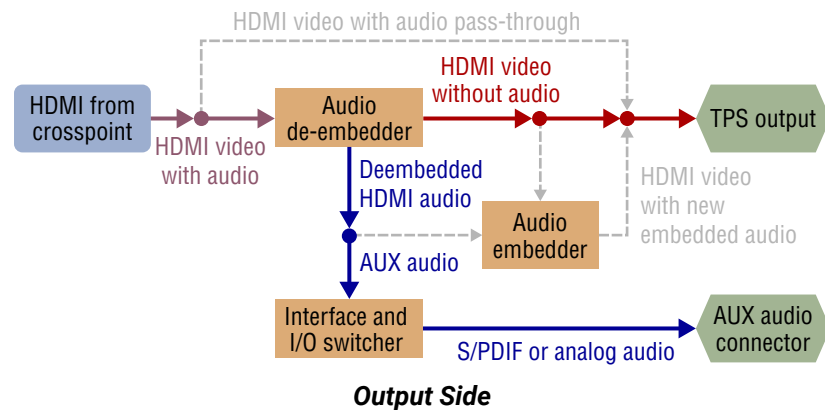

Output Side

#analogaudio

**(E) HDMI Pass-through and De-embed to Aux Audio**

The HDMI video (with embedded audio) goes towards the HDMI crosspoint (in the case of input cards) or the output port (in the case of output card) without any modification and the audio channel of the HDMI signal appears on the auxiliary port.

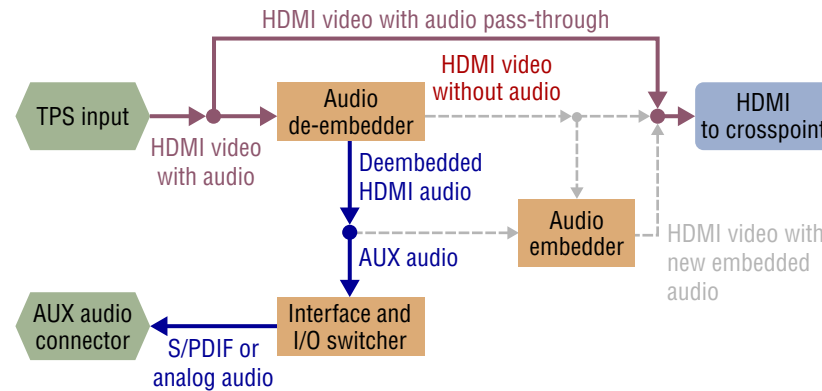

Input Side

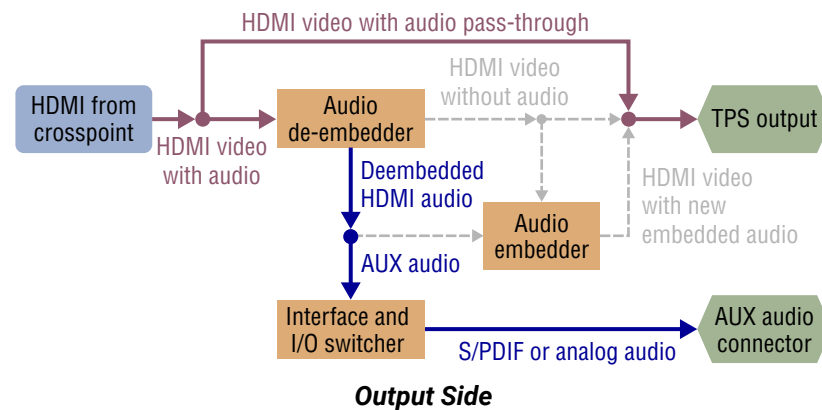

Output Side

#analogaudio

**4.7. TPS Link Modes**

The MX-TPS and MX-TPS2 boards have adjustable TPS link mode options for every port separately. The modes can be the followings:

- **Auto:** The TPS mode is determined automatically.
- **HDBaseT:** Ideal for high resolution signals up to 4K for reduced distances.
- **Long Reach:** Ideal for big distances up to 1080p@60Hz.
- **RS232:** Only RS-232 communication is transmitted (at 9600 baud).
- **RS232+Eth:** Only RS-232 (at 9600 baud) and Ethernet communication is transmitted.

**WARNING! Use only the Auto TPS link mode with third-party devices.**

The negotiated TPS working mode is determined by the setting of each parties:

	TX side	RS232	RS232+Eth	HDBaseT	Long Reach	Auto
RX side		RS232	RS232+Eth	HDBaseT	Long Reach	Auto
RS232		RS232	RS232	RS232	RS232	RS232
RS232+Eth		RS232	RS232+Eth	RS232+Eth	RS232+Eth	RS232+Eth
HDBaseT		RS232	RS232+Eth	HDBaseT	Long Reach	HDBaseT
Long Reach		RS232	RS232+Eth	Long Reach	Long Reach	Long Reach
Auto		RS232	RS232+Eth	HDBaseT	Long Reach	HDBaseT*

The available cable lengths can be found in the [Maximum Cable Lengths \(TP Boards\)](#) section.

\* If there is a valid HDMI/DVI signal is on the TX side, the TPS mode will be HDBaseT on both sides. If the transmitter does not transmit HDMI/DVI signal, the TPS mode will be changed to RS232 only or RS232 + ETH mode automatically. Long reach mode is not available when both sides are set to Auto mode. #rs232 #rs-232 #serial

When one of the devices is configured to manual operation mode selection, the other device may be placed in automatic mode. In this case, the mode transition negotiation is initiated by the host-managed device and the auto-mode device follows through.



### 4.8. About the Ethernet (TPS and TPS2 Boards)

If the MX-TPS or MX-TPS2 boards connected to the LAN they are able to feed Ethernet devices with a standard 10/100 Base-T link. The boards have an Ethernet switch with 1+8 ports. There is no connection between this switch and the other cards, not even the CPU card.

**INFO:** TPS/TPS2 boards accept independent LAN up-link which is used to supply devices with a network connection.

The Ethernet labeled connector on the I/O card is connected to the switch directly. The other TPS input and output ports are connected to the switch via the HDBaseT® Tx/Rx IC. (This microchip is able to separate the incoming TPS stream into VIDEO, AUDIO, RS-232, POWER and ETHERNET signal. These signals are packed in the TPS signal, as well.)

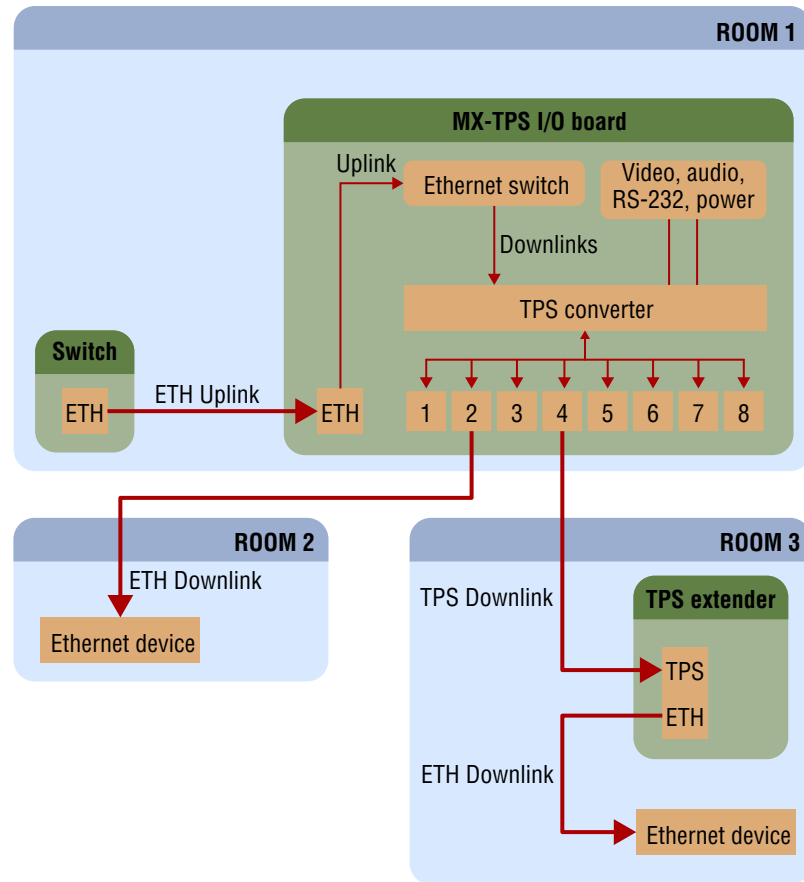

Ethernet and TPS Connectors for LAN

If the TPS board is connected to LAN and the Ethernet channel is enabled on a TPS port, the device which is connected\* to this port is supplied with a network connection. This connected device can be a TPS extender or if the TPS port has the AUTO mode setting it also can be a standard Ethernet equipment. The TPS port with AUTO mode setting is able to recognize the type of the connection and if it is a standard LAN the port swap into Ethernet fallback mode. In this case, it is equivalent with a port of an Ethernet switch.

\* If the remote power is disabled on a TPS port of a TPS card it works as a HDBaseT compliant product and the connected device can be a third-party HDBaseT compliant receiver (to the output board) or transmitter (to the input board).

**WARNING!** Always set the AUTO mode on a board before connecting a third-party device!

#### 4.8.1. Enable and Disable the Ethernet

The LAN can be enabled or disabled for every single TPS port with protocol command. The example command is referred the 2nd port of an MX-TPS output board.

The current state can be queried with the following command:

```
> {:TPS#2@S0=?}
```

The second parameter of the response represents the Ethernet state. If it is 1 then the Ethernet is enabled for the 2nd port of the output board. If it is 0 then the Ethernet is disabled for that port.

```
< (TPS#2@S0=A;1;0;0;1;00000000;00000000;0;0000;29;)
```

The same command is suitable for enabling or disabling this parameter. To enable, use:

```
> {:TPS#2@S0=x;1}
< (TPS#2@S0=A;1;0;0;1;00000000;00000000;0;0000;34;)
```

To disable, swap the 1 to 0:

```
> {:TPS#2@S0=x;0}
< (TPS#2@S0=A;0;0;0;1;00000000;00000000;0;0000;34;)
```

**ATTENTION!** Connecting the MX-CPU card to the LAN via MX-TPS board is not recommended.

**INFO:** The first parameter is the working mode. The x character is recommended to use in the setting command because the x does not change the parameter so it remains unaltered.

For more information about the TPS command see the TPS and TPS2 Port section.

#### 4.8.2. Avoid Causing an Ethernet Loop

A TPS board (actually the Ethernet switch of the board) can be uplinked to the same LAN only once to avoid an Ethernet loop. In this case, if the other network devices are not able to handle Ethernet loops the LAN network may break down.

##### Example

The TPS board connects firstly to the router of the ROOM 1 via the switch of the ROOM 2. The HDMI-TPS-TX95 in the ROOM 3 is connected to the LAN via TPS link. If the installer does not know the transmitter has already connected to the LAN via TPS and links the transmitter to the switch – shown by the brown arrow in the picture – it results an Ethernet loop – demonstrated by the red lines on below picture.

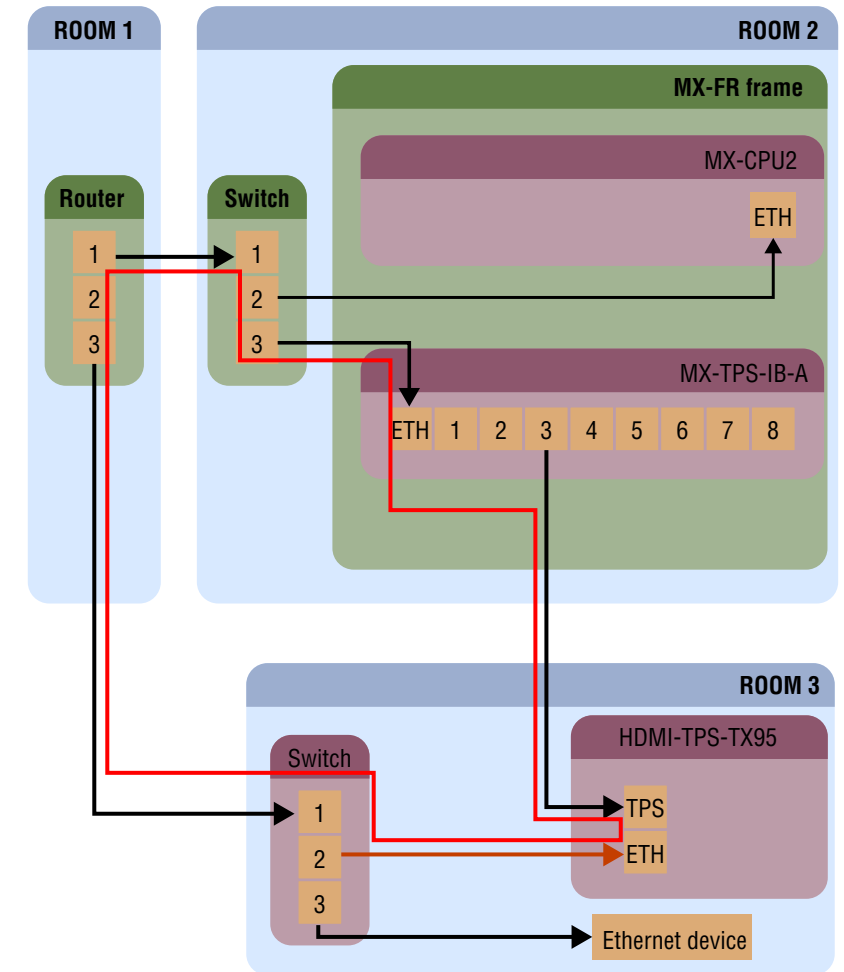

Ethernet Loop

## 4.9. LCD Control Panel Operation

### 4.9.1. Basic Concept

There are three operating modes of the LCD menu.

#### Normal Mode

Most settings can be done in this mode. It is active when none of the **EDID** or the **SIGNAL PRESENT** button lights.

#### EDID Mode

Use this mode to set up the emulated EDID on the inputs, learn EDID from the outputs or to view the EDID memory. Enter or exit this mode by pressing the **EDID** button. The illuminated **EDID** button shows that this mode is active.

#### Signal Present Mode

This mode is for checking the presence of incoming signals and display devices. Enter or exit this mode by pressing the **SIGNAL PRESENT** button. The illuminated **SIGNAL PRESENT** button shows that this mode is active.

#### Navigation

The front panel LCD has 4 lines and 20 characters in each line. The navigation buttons and the applied symbols are listed as follows:

Button		Function
▲	up	scroll between menu items
▼	down	
◀	left	step into/out from a submenu or change the value of the current parameter
▶	right	step into/out from a submenu or change the value of the current parameter
◆	enter	step in a submenu or execute changes
●	escape	set back to the previous submenu
Symbol		Function
.		indicates the currently selected menu item
>>		shows the current submenu
< and >		changeable values are in angle brackets
[*]		indicates an active function

### Menu Structure

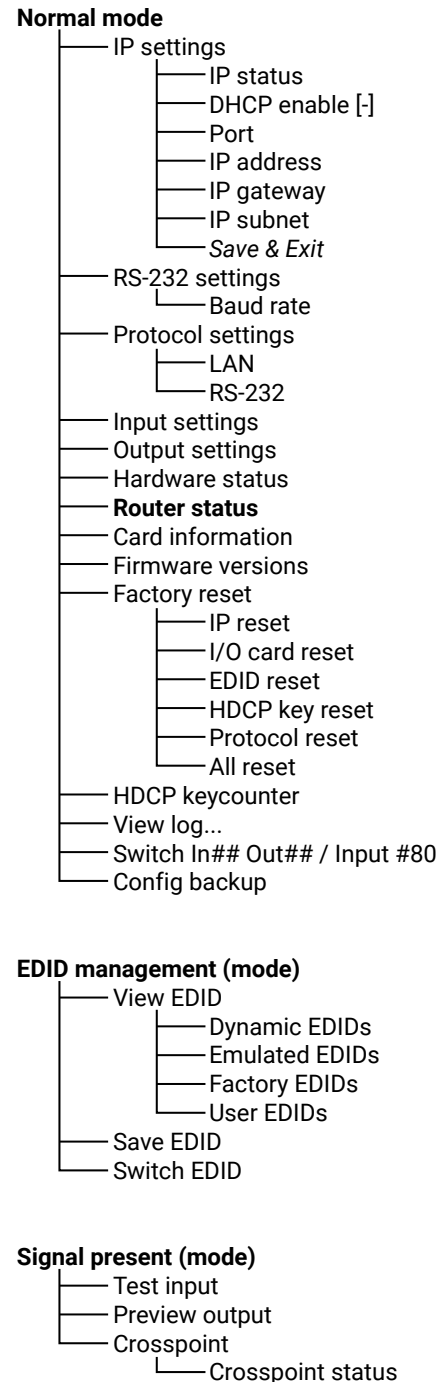

### 4.9.2. Normal Mode

Up ▲ and down ▼ buttons select between menu items. More items become visible when scrolling down. Enter ◆ or right ▶ buttons step in submenus.

```

>> IP settings
>> RS-232 settings
>> Protocol settings
>> Input settings
    
```

#### 4.9.2.1. IP Settings Menu

This menu contains the IP status submenu, **DHCP enable** checkbox and **TCP/IP port** value. If the DHCP is switched off then IP address, Default gateway, and Subnet mask can be set as well. Changes take place only when **Save settings** is executed. Press the **escape ●** button to return to the main menu without saving any changes.

```

>> IP settings
>> IP SETTINGS
>> IP status
>> DHCP enable [*]
>> Port
    
```

#### IP Status Submenu

Navigate to this submenu and press enter ◆ or right ▶ button to see the current IP address, port, gateway and subnet mask. No changes can be made in this submenu. Press **escape ●** to return to the previous menu.

```

IP: 192.168.002.105
Port: 10001
GW: 000.000.000.000
SM: 255.255.255.000
    
```

#### DHCP Enable Checkbox #dhcp

Navigate to this item with the up ▲ and down ▼ buttons. Pressing enter ◆ toggles **DHCP state**. If DHCP is inactive then the IP address, Gateway, and Subnet mask can be set manually to fix values.

```

IP SETTINGS
IP status
DHCP enable [*]
Port
    
```

#### Port Value

Navigate to this item with the up ▲ and down ▼ buttons. Use the left ◀ and right ▶ buttons to change the **TCP/IP port** value.

```

PORT SETTING
Port number
. 10001 .
    
```

#ipaddress #network

### IP Address Submenu

Navigate to this item with the **up ▲** and **down ▼** buttons. This submenu appears only if DHCP is disabled. Press **enter ◆** or **right ►** button to step in.

```
IP SETTINGS
DHCP enable [ ]
Port
- IP address >>
```

The four part of the fix IP address can be set separately. Use the **left ◀** and **right ►** buttons to select the part, and then use the **up ▲** and **down ▼** buttons to change the value of that part. Press **escape ●** button to return to the previous menu.

```
IP SETTINGS
IP address
- 192.168.002.102 -
---
```

### Default Gateway Submenu

This submenu can be used the same like IP address submenu.

### Subnet Mask Submenu

This submenu can be used the same like IP address submenu.

### Save Settings

Any changes made in the IP settings menu come alive only when **Save settings** is executed. To do this, navigate to this item with the **up ▲** and **down ▼** buttons, then press **enter ◆** or **right ►** button.

```
IP SETTINGS
Default gateway
Subnet mask
- Save settings >>
```

The **Operation in progress** message appears on the LCD. If saving the settings succeed then **Operation done!** message is shown for 2 seconds.

**INFO:** If you get **Operation Failed** message please try again.

### 4.9.2.2. RS-232 Settings Menu

The serial port baud rate value can be set here. Use the **left ◀** and **right ►** buttons to change the baud rate value. Changes take place immediately when modifying the value. Press the **escape ●** button to return to the main menu.

```
- RS-232 settings >>
```

```
RS-232 settings
- Baud rate: -
- < 57600 >-
```

#rs232 #rs-232 #serial

### 4.9.2.3. Protocol Settings Menu

Navigate to this menu in the main menu list and press the **enter ◆** or the **right ►** button to set the communication protocol for each interface separately.

```
- Protocol settings >>
```

Use the **up ▲** and **down ▼** buttons to select an interface, and then select the desired protocol with the **left ◀** and **right ►** buttons. Changes take place immediately when modifying the value. A beep sound indicates that the protocol is changed.

```
Protocol settings
- LAN: -
- < Lightware >-
RS-232:
```

```
Protocol settings
Lightware
- RS-232: -
- < Protocol #2 >-
```

Press the **escape ●** button to return to main menu.

### 4.9.2.4. Input Settings Menu

Navigate to this menu in the main menu list and press **enter ◆** or **right ►** button.

```
- Input settings >>
```

### Select Input Port Submenu

Use the **up ▲** and **down ▼** buttons to select the port that needs adjustment and then press the **enter ◆** or **right ►** button.

```
Select input
Input 1
- Input 2 >>
Input 3
```

The items in the following submenu depend on the interface board type as different I/O boards have different capabilities.

### Input Port Settings Submenu (DVI-D Type)

*Supported Boards: MX-DVID-IB, MX-DVI-TP-IB(+)*

The input cable equalization can be set in 0.1dB increments from **0 dB** to **41.0 dB**, or **Auto**. Use the **left ◀** and **right ►** buttons to change the value.

```
Input 1 settings
- Equalization -
- < 40.7 dB >-
```

### Input Port Settings Submenu (HDMI Type)

*Supported Boards: MX-HDMI-IB, MX-DVI-HDCP-IB, MX-HDMI-TP-IB, MX-CPU2 Test input*

Use the **up ▲** and **down ▼** buttons to select the setting to be changed.

```
Input 9 settings
- Equalization -
- < Auto >-
HDCP enable [*]
```

The input cable equalization can be set to **3, 9, 25, 35, 40 dB**, or **Auto**.

Use the **left ◀** and **right ►** buttons to change the value. (exception: MX-CPU2 Test input port does not have cable equalization!)

```
Input 9 settings
Equalization
Auto
- HDCP enable [*]-
```

The HDCP capability on the input port can be enabled or disabled with the **HDCP enable** checkbox. Press the **enter ◆** to toggle state.

```
Input 9 settings
HDCP enable [*]
- Color range -
- < Compress >-
```

The **Color range** conversion can be set to **compress, expand** or **Auto**. Use the **left ◀** and **right ►** buttons to change the value.

### Input Port Settings Submenu (DVI-I Type)

*Supported Boards: MX-DVII-HDCP-IB, MXD-UMX-IB*

Use the **up ▲** and **down ▼** buttons to select the parameter to be changed. Use the **left ◀** and **right ►** buttons to change the value.

```
Input 2 settings
- Interface -
- < Auto >-
Port mode
```

The **Interface** parameter sets the signal type which is connected to the input port. It can be set to **Auto, Analog auto, Analog RGB, Analog YUV**, or **Digital**.

```
Input 2 settings
- Port mode -
- < Pass HDMI >-
Audio source
```

The **Port mode** setting affects the signal type which is sent to the crosspoint. All incoming analog signals are digitized on the input. DVI or HDMI signal can be sent to the crosspoint. This parameter can be **fixed DVI** or **pass HDMI**. The latter option uses HDMI signal if the incoming signal is HDMI as well. #hdcp

```
Input 2 settings
- Audio source -
- < DVII >-
HDCP enable
```

The **Audio source** parameter is accessible only with MXD-UMX-IB. It can be set to **No Audio, DVII** (embedded audio) or **Add-on**. The latter option takes the audio signal from the analog stereo or the S/PDIF inputs according to the **Add-on source** setting. The HDCP capability on the input can be enabled or disabled with the **HDCP enable** setting. The **Analog settings** submenu affects the analog video input parameters.

```
Input 2 settings
- HDCP enable -
- < Enabled >-
Analog settings
```

```
Input 2 settings
HDCP enable
Enabled
- Analog settings >>
```

The **Add-on source** setting is accessible only with MXD-UMX-IB. The analog stereo and S/PDIF conversion functions can be set here. Two signal conversions are shown. **S** represents the S/PDIF port, **An** represents the analog stereo port and **D** represents the digital audio which is embedded in the HDMI signal on the video port. Possible options are shown below: `#analogaudio #audio`

```
Input 2 settings
-Add-On Source      -
- An->D:An->S      -
Analog Audio Input
```

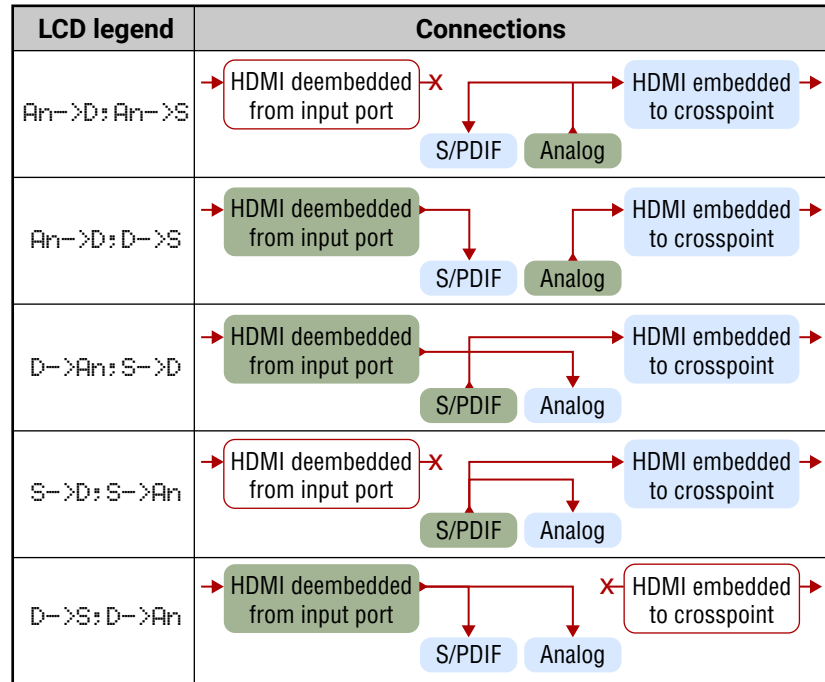

The **Analog audio Input** submenu contains settings like volume, balance, etc. for the analog stereo audio port when it is configured as an input.

Available only at MXD-UMX-IB.

```
Input 2 settings
Add-On Source
An->D:An->S
- Analog Audio Inpu>>
```

The **Analog audio Output** submenu contains settings like volume, balance, etc. for the analog stereo audio port when it is configured as an output.

Available only at MXD-UMX-IB.

```
Input 2 settings
An->D:An->S
Analog Audio Input
- Analog Audio Out>>
```

### Input Port Settings Submenu (DVIDL type)

Supported Boards: MX-DVIDL-IB

The input cable equalization can be set to **3, 9, 25, 35, 40 dB**, or **Auto**. Use the **left** ◀ and **right** ▶ buttons to change the value.

```
Input 8 settings
-Equalization      -
- < 9 dB          >-
```

### Input Port Settings Submenu (3G-SDI type)

Supported Boards: MX-3GSDI-IB

Use the **up** ▲ and **down** ▼ buttons to select the parameter to be changed. Use the **left** ◀ and **right** ▶ buttons to change the value.

```
Input 17 settings
-Equalization      -
- < Auto           >-
Audio source
```

The **Equalization** can be set to **Auto** (recommended) or **0 dB**. The later setting disables equalization.

The **Audio source** selects the audio signal that is embedded in the forwarded HDMI stream: it can be set to **SDI, S/PDIF** or **No audio**.

```
Input 17 settings
-Audio source      -
- < SDI            >-
Video mode
```

The **Video mode** sets the signal type to DVI or HDMI mode which is sent towards the matrix crosspoint. The **Audio dependent** mode sends HDMI signal to the crosspoint if the audio source is set to embed audio from SDI or S/PDIF. The **Frame compatible** mode sets the signal type according to the output board types in the matrix frame. If there are only HDMI compatible output boards then the signal type will be HDMI.

```
Input 17 settings
-Video mode        -
- < Audio depend. >-
Aud.Preset
```

The incoming SDI embedded audio channels can be rearranged and allocated to HDMI audio channels. The channel allocation preset can be selected with the **Aud.Preset** setting. SDI audio allocation presets are common for all SDI input ports in the matrix.

```
Input 17 settings
Audio depend.
- Aud.Preset       -
- < FACT1          >-
```

### Input Port Settings Submenu (TPS type)

Supported Boards: MX-TPS-IB, -S, -A, MX-TPS2-IB-P, -AP, -SP, MX-4TPS2-4HDMI-IB-P\*, -AP\*, -SP\*

\* only the four TPS2 ports of the boards.

Use the **up** ▲ and **down** ▼ buttons to select the parameter to be changed. Use the **left** ◀ and **right** ▶ buttons to change the value.

```
Input 7 settings
- HDCP enable     [*] -
TPG mode
Off
```

The HDCP capability on the input port can be enabled or disabled with the **HDCP enable** checkbox. `#hdcp`

Press **enter** ◆ to toggle the state.

The **Test pattern generator** helps to test and troubleshoot video hook-ups and displays. Use the **left** ◀ and **right** ▶ buttons to change the value. **On** turns on, **Off** turns off the test pattern generator. If it is off, the output gives a solid black, 480p video signal. (This is the default value.) In the case of **No signal mode**, the output does not give any signal.

```
Input 7 settings
HDCP enable [*]
- TPG mode        -
- < No signal mode >-
```

Three options can be selected for the resolutions of the TPG: **480p 60Hz, 576p 60Hz** and **Odd p. signal**. Odd p. signal means the resolution of the test pattern is the same as the closest smaller or equal odd input's resolution. (Input 1 for the input 1 and 2, Input 3 for input 3 and 4, and so on...) If there is no video signal on the odd input, the generator gives a 480p signal.

```
Input 7 settings
On
- TPG clk         -
- < Odd p. Signal >-
```

```
Input 7 settings
Input (Odd p.)
- TPG Pattern     -
- < Color bar     >-
```

`#nosyncscreen #testpattern`



The pattern can be **solid green, blue, black, white or black and white ramp** and **chessboard** or **color bar**. The **cycle** changes all the listed ones periodically.

The **Audio mode** settings are available in the case of MX-TPS-IB-A and MX-TPS-IB-S boards. Here can be selected which is embedded in the forwarded HDMI signal can be set to **No audio (A)**, **HDMI audio passth. (B)**, **Embed from Ext (C)**, **Deembded to Ext (D)** or **HDMI + deemb (E)**.

```
Input 7 settings
Color bar
·Audio mode      ·
·<HDMI + deemb  >·
```

For detailed information about the audio settings see the [Audio Options](#) section. *#analogaudio #audio*

The **Analog Audio Input** settings are available in the case of an MX-TPS-IB-A board. The submenu contains the attributes of the analog audio signal.

```
Input 7 settings
Audio mode
HDMI + deembded
·Analog Audio Inpu>>
```

If the auxiliary audio port is defined as input (embed) the options are: **volume, balance, gain, phase (invert), DC Filter**.

```
Analog Audio Input·
·Volume           ·
·< 0 dB          >·
Balance
```

In the case of output (deembded) the options are: **volume, balance, bass, treble, deemphasis, phase (invert), DC Filter**.

The TPS mode can be **HDBaseT, Longreach, Automatic, RS232 only** and **RS232+ETH only**.

```
Input 7 settings
Analog Audio Input·
·TPS mode        ·
·<HDBaseT       >·
```

For detailed information about the TPS modes see the [TPS Link Modes](#) section.

The **PoE** setting (remote Power over Ethernet) is available only in the case of TPS2 boards. Set the desired mode (**enable/disable**) on the given port.

```
Input 17 settings
Automatic
·PoE             ·
·<Disable       >·
```

*#gain #nosyncscreen #testpattern*

### Input Port Settings Submenu (HDMI-3D type)

*Supported Boards: MX-HDMI-3D-IB, -S, -A; MX-DVI-4K-IB*

Use the **up ▲** and **down ▼** buttons to select the parameter to be changed. Use the **left ◀** and **right ▶** buttons to change the value.

The HDCP capability on the input port can be enabled or disabled with the **HDCP enable** checkbox.

```
Input 3 settings
·HDCP enable    [*]·
TPG mode
Off
```

Press **enter ◆** to toggle state.

The **Test pattern generator** makes it simple to test and troubleshoot video hook-ups and displays. Use the **left ◀** and **right ▶** buttons to change the value. **On** turns on, **Off** turns off the test pattern generator. If it is off, the output gives a solid black, 480p video signal. (This is the default value.) In the case of **No signal mode**, the output does not give any signal. *#hdcpc*

```
Input 3 settings
HDCP enable    [*]
·TPG mode      ·
·<No signal mode >·
```

Three options can be selected for the resolutions of the TPG: **480p 60Hz, 576p 60Hz** and **Odd p. signal**. Odd p. signal means the resolution of the test pattern is the same as the closest smaller or equal odd input's resolution. (Input 1 for the input 1 and 2, Input 3 for input 3 and 4, and so on...) If there is no video signal on the odd input, the generator gives a 480p signal.

```
Input 3 settings
On
·TPG clk       ·
·<Odd p. Signal >·
```

The pattern can be **solid green, blue, black, white or black and white ramp** and **chessboard** or **color bar**. The **cycle** changes all the listed ones periodically.

```
Input 3 settings
Input (odd p.)
·TPG pattern   ·
·<Color bar   >·
```

The **Audio mode** settings are available in the case of MX-HDMI-3D-IB-A and MX-HDMI-3D-IB-S boards. Here can be selected which is embedded to the forwarded HDMI signal can be set to **No audio (A)**, **HDMI audio passth. (B)**, **Embed from Ext (C)**, **Deembded to Ext (D)** or **HDMI + deemb (E)**.

```
Input 3 settings
Color bar
·Audio mode    ·
·<HDMI + deemb >·
```

```
Input 3 settings
Audio mode
HDMI + deembded
·Analog Audio Inpu>>
```

The **Analog Audio Input** settings are available in the case of an MX-TPS-IB-A board. The submenu contains the attributes of the analog audio signal. *#audio #analogaudio*

If the auxiliary audio port is defined as **input (embed)** the options are: **volume, balance, gain, phase (inversion), DC Filter**.

```
Analog Audio Input·
·Volume           ·
·< 0 dB          >·
Balance
```

In the case of **output (deembded)** the options are: **volume, balance, bass, treble, deemphasis, phase (inversion), DC Filter**.

### Input Port Settings Submenu (HDMI-OPT type)

*Supported Boards: MX-HDMI-OPT-IB-SC, MX-HDMI-OPT-IB-LC, MX-HDMI-OPT-IB-ST, MX-HDMI-OPT-IB-NT*

The remote serial communication feature can be enabled or disabled.

For the RS-232 control over fiber function (see details in the [RS-232 Command Transmission](#) section) enable the **Serial Passth** option. That allows the serial commands to be sent over the fiber cable. It is recommended to disable this feature if not used.

```
Input 17 settings
·Serial Passth[ ]·
```

#### 4.9.2.5. Output Settings Menu

Navigate to this menu in the main menu list and press **enter ◆** or **right ▶** button.

```
·Output settings >>
```

#### Select Output Port Submenu

Use the **up ▲** and **down ▼** buttons to select the port that needs adjustment and then press the **enter ◆** or **right ▶** button.

```
Select output
Output 1
·Output 2    >>
Output 3
```

The items in the following submenu depend on the interface board type as different I/O boards have different capabilities. Use the **up ▲** and **down ▼** buttons to select the setting to be changed.

### Output Port Settings Submenu (DVI-D type)

Supported Boards: MX-DVID-OB, MX-DVI-TP-OB(+), MX-DVI-OPT-OB-R

The **Deskewing** can be enabled or disabled with this checkbox. The default setting is disabled. Press **enter** **◆** to toggle state.

```
Output 1 settings
-Deskewing [*] -
  Deskew level
    4
```

The **Deskew level** can be set using the **left** **◀** and **right** **▶** buttons. Makes effect only if the deskewing is enabled. The default setting is 4.

```
Output 1 settings
  Deskewing [*]
-Deskew level -
-< 4 >-
```

The **PLL filter** can be enabled or disabled with this checkbox. The default setting is enabled. Press **enter** **◆** to toggle state.

```
Output 1 settings
-PLL filter [*] -
  PLL value
    4
```

The **PLL value** can be set using the **left** **◀** and **right** **▶** buttons. Makes effect only if the PLL filter is enabled. The default setting is 4.

```
Output 1 settings
  PLL filter [*]
-PLL value -
-< 4 >-
```

### Output Port Settings Submenu (HDMI type)

Supported Boards: MX-HDMI-OB, MX-DVI-HDCP-OB, MX-HDMI-TP-OB, MXD-HDMI-TP-OB, MX-CPU2 Preview output

The **Signal mode** can be set to **DVI**, **HDMI 24bit**, **HDMI 30bit**, **HDMI 36bit** or **Auto** mode. The **Auto** option sets the signal mode regarding the attached display device's EDID and the incoming signal. Use the **left** **◀** and **right** **▶** buttons to change the value.

```
Output 9 settings
-Signal mode -
-< HDMI 24 bit >-
  Colorspace
```

The **Colorspace** can be set to **RGB**, **YUV444**, **YUV422** or **Auto**. Convert the color space on the output to the given type. Please note that DVI signals support only RGB color space. Use the **left** **◀** and **right** **▶** buttons to change the value.

```
Output 9 settings
-Colorspace -
-< RGB >-
  Color range
```

The **Colorrange** can be set to **compress**, **expand** or **Auto**. Use the **left** **◀** and **right** **▶** buttons to change the value.

With the **PCM subsample** setting the 2-channel PCM audio can be subsampled by 2x or 4x. The minimum of the new sampling frequency is 44.1 kHz. Use the **left** **◀** and **right** **▶** buttons to change the value.

```
Output 9 settings
-Colorrange -
-< Expand >-
  PCM subsample
```

The **Encryption** option sets the HDCP encryption on the output. The **Auto** setting applies encryption when the incoming signal is encrypted. The **Always** setting forces encryption on any incoming video signal. Use the **left** **◀** and **right** **▶** buttons to change the value.

```
Output 9 settings
-PCM subsample -
-< 2x >-
  Encryption
```

```
Output 9 settings
  2x
-Encryption -
-< Auto >-
```

### Output Port Settings Submenu (DVIDL type)

Supported Board: MX-DVIDL-OB

The **DualLink mode** can be set to enable or disable the wires needed for Dual-Link signals. The **Disable mode** virtually disconnects the Dual-Link TMDS wires. The **Auto** mode considers the currently connected input port type. Use the **left** **◀** and **right** **▶** buttons to change the value.

```
Output 4 settings
-DualLink mode -
-< Enable >-
```

### Output Port Settings Submenu (OPT type)

Supported Boards: MX-DVI-OPT-OB, MX-HDMI-OPT-OB

The laser on each output port can be enabled or disabled. Disabling unused laser outputs can lengthen their lifespan. Use the **left** **◀** and **right** **▶** buttons to change the value.

```
Output 15 settings
-Laser enable -
-< On >-
```

### Output Port Settings Submenu (TPS type)

Supported Boards: MX-TPS-OB, -S, -A, MX-TPS2-OB-P, -AP, -SP; MX-4TPS2-4HDMI-OB, -A, -S, -P, -AP, -SP

Use the **up** **▲** and **down** **▼** buttons to select the parameter to be changed. Use the **left** **◀** and **right** **▶** buttons to change the value.

The **Signal mode** can be set to **DVI**, **HDMI** or **Auto mode**. The **Auto** option sets the signal mode regarding the attached display device's EDID and the incoming signal. Use the **left** **◀** and **right** **▶** buttons to change the value.

```
Output 7 settings
-Signal mode -
-< HDMI >-
  Encryption
```

The **Encryption** option sets the HDCP encryption on the output. The **Auto** setting applies encryption when the incoming signal is encrypted. The **Always** setting forces encryption on any incoming video signal. Use the **left** **◀** and **right** **▶** buttons to change the value. *#hdcp*

```
Output 7 settings
  Auto
-Encryption -
-<Auto >-
```

For detailed information about the HDCP modes see the [HDCP Management](#) section. *#nosyncscreen #testpattern*

The **Test pattern generator** makes it simple to test and troubleshoot video hook-ups and displays. Use the **left** **◀** and **right** **▶** buttons to change the value. **On** turns on, **Off** turns off the test pattern generator. If it is on, the output gives a solid red, 480p video signal. (This is the default value.) In the case of **No signal mode**, the output does not give any signal.

```
Output 7 settings
  Auto
-TPG mode -
-<Off >-
```

Three options can be selected for the resolutions of the TPG: **480p 60Hz**, **576p 60Hz** and **Odd p. signal**. **Odd p. signal** means the resolution of the test pattern is the same as the closest smaller or equal odd input's resolution. (Input 1 for the input 1 and 2, Input 3 for input 3 and 4, and so on...) If there is no video signal on the odd input, the generator gives 480p signal.

```
Output 7 settings
  Off
-TPG clk -
-<Odd p. Signal >-
```

The pattern can be **solid green**, **blue**, **black**, **white** or **black and white ramp** and **chessboard** or color bar. The **cycle** changes all the listed ones periodically.

```
Output 7 settings
  Color bar
-Audio mode -
-<HDMI + deembed >-
```

The **Audio mode** settings are available in the case of MX-TPS-OB-A and MX-TPS-OB-S boards. Here can be selected which is embedded in the forwarded HDMI signal can be set to **No audio (A)**, **HDMI audio passth.** (B), **Embed from Ext (C)**, **Deembed to Ext (D)** or **HDMI + deemb (E)**.

The DVI or HDMI 5V line can be controlled on an output port with the **PWR5V mode**. If it is **On** the 5VDC is always active. If it is **Off** the port never sends the 5 VDC. *#power5v*

```
Output 7 settings
HDMI + deemb
-PWR5V mode      -
-<Auto           >*
```

**ATTENTION!** If the 5V line is off sink devices do not send HotPlug signal in most cases and their EDIDs will not be read.

The **Auto** mode means the port gives the 5V but if the video signal changes (e.g. resolution) it turns off the 5V for 1 sec and turns it on again.

**TIPS AND TRICKS:** This mode is useful for sink devices which are not able to handle properly the changing of the video signal.

The **Analog Audio Output** settings are available in the case of boards with analog audio add-on ("-A" extension). The submenu contains the attributes of the analog audio signal.

```
Output 7 settings
Audio mode
HDMI + deemb
-Analog Audio InFu>>
```

If the auxiliary audio port is defined as **input** (embed) the options are the followings: **volume**, **balance gain**, **phase (inversion)**, **DC Filter**.

In the case of **output** (deembed) the options are: **volume**, **balance**, **bass**, **treble**, **deemphasis**, **phase (inversion)**, **DC Filter**.

```
Analog Audio Input-
-Volume          -
-< 0 dB          >*
Balance
```

The TPS mode can be **HDBaseT**, **Longreach**, **Automatic**, **RS232 only** and **RS232+ETH only**.

For detailed information about the TPS modes see the [TPS Link Modes](#) section.

```
Output 7 settings
Analog Audio Input.
-TPS mode        -
-<HDBaseT        >*
```

The **PoE** setting (remote Power over Ethernet) is available only in the case of TPS2 boards. Set the desired mode (**enable/disable**).

```
Input 17 settings
Automatic
-PoE             -
-<Disable        >*
```

*#audio*      *#analogaudio*    *#gain*

### Output Port Settings Submenu (HDMI-3D type)

*Supported Boards: MX-HDMI-3D-OB, MX-HDMI-3D-OB-S, MX-HDMI-3D-OB-A, MX-4TPS2-4HDMI-OB, -A, -S, -P, -AP, -SP, MX-DVI-4K-OB #hdcp*

Use the **up ▲** and **down ▼** buttons to select the parameter to be changed. Use the **left ◀** and **right ▶** buttons to change the value.

The **Signal mode** can be set to **DVI**, **HDMI** or **Auto mode**. The **Auto** option sets the signal mode according to the attached display device's EDID and the incoming signal. Use the **left ◀** and **right ▶** buttons to change the value.

```
Output 3 settings
-Signal mode     -
-<HDMI           >*
Encryption
```

The **Encryption** option sets the HDCP encryption on the output. The **Auto** setting applies encryption when the incoming signal is encrypted. The **Always** setting forces encryption on any incoming video signal. Use the **left ◀** and **right ▶** buttons to change the value. For detailed information about the HDCP modes see the [HDCP Management](#) section.

```
Output 3 settings
-Encryption      -
-<Always         >*
TPG mode
```

The **Test pattern generator** makes it simple to test and troubleshoot video hook-ups and displays. Use the **left ◀** and **right ▶** buttons to change the value. **On** turns on, **Off** turns off the test pattern generator. If it is **off**, the output gives a solid black, 480p video signal. (This is the default value.) In the case of **No signal mode**, the output does not give any signal. *#nosyncscreen #testpattern*

```
Output 3 settings
Auto
-TPG mode        -
-<on             >*
```

Three options can be selected for the resolutions of the TPG: **480p 60Hz**, **576p 60Hz** and **Odd p. signal**. **Odd p. signal** means the resolution of the test pattern is the same as the closest smaller or equal odd input's resolution. (Input 1 for the input 1 and 2, Input 3 for input 3 and 4, and so on...) If there is no video signal on the odd input, the generator gives a 480p signal.

```
Output 3 settings
On
-TPG clk         -
-<Odd p. Signal >*
```

```
Output 3 settings
Odd p. Signal
-TPG pattern     -
-<Color bar      >*
```

The pattern can be **solid green**, **blue**, **black**, **white** or **black and white ramp** and **chessboard** or **color bar**. The **cycle** changes all the listed ones periodically.

The **Audio mode** settings are available in the case of MX-HDMI-3D-OB-A and MX-HDMI-3D-OB-S boards. Here can be selected which is embedded in the forwarded HDMI signal can be set to **No audio (A)**, **HDMI audio passth.** (B), **Embed from Ext (C)**, **Deembed to Ext (D)** or **HDMI + deemb (E)**. *#power5v*

```
Output 3 settings
Audio mode
HDMI + deemb
-Analog Audio InFu>>
```

The DVI or HDMI 5V line can be controlled on an output port with the **PWR5V mode**. If it is **On** the 5V DC is always active. If it is **Off** the port never sends the 5 V DC.

```
Output 3 settings
HDMI + deemb
-PWR5V mode      -
-<Auto           >*
```

**ATTENTION!** If the 5V line is off sink devices do not send HotPlug signal in most cases and their EDIDs will not be read.

The **Auto** mode means the port gives the 5V but if the video signal changes (e.g. resolution) it turns off the 5V for 1 sec and turns it on again.

**INFO:** This mode is useful for sink devices which are not able to handle properly the changing of the video signal.

The **Analog Audio Output** settings are available in the case of MX-TPS-OB-A board. The submenu contains the attributes of the analog audio signal.

```
Output 3 settings
Audio mode
HDMI + deemb
-Analog Audio InFu>>
```

If the auxiliary audio port is defined as **input** (embed) the options are: **volume**, **balance**, **gain**, **phase (inversion)**, **DC Filter**.

```
Analog Audio Input-
-Volume          -
-< 0 dB          >*
Balance
```

In the case of **output** (deembed) the options are: **volume**, **balance**, **bass**, **treble**, **deemphasis**, **phase (inversion)**, **DC Filter**.

```
Volume
0 dB
-Balance         -
-< 50 %         >*
```



### Output Port Settings Submenu (HDMI-OPT-R type)

Supported Boards: MX-HDMI-OPT-OB-R-SC, MX-HDMI-OPT-OB-R-LC, MX-HDMI-OPT-OB-R-ST, MX-HDMI-OPT-OB-R-NT

Use the up ▲ and down ▼ buttons to select the parameter to be changed. Use the left ◀ and right ▶ buttons to change the value.

The **Signal mode** can be set to **No change**, **DVI** or **HDMI**. The **No change** option does convert the output signal into DVI or HDMI video. Use the left ◀ and right ▶ buttons to change the value. #hdcp

```
Output 16 settings
- Signal mode      -
- <HDMI           >-
Encryption
```

The **Encryption** option sets the HDCP encryption on the output. The **Auto** setting applies encryption when the incoming signal is encrypted. The **Always** setting forces encryption on any incoming video signal. Use the left ◀ and right ▶ buttons to change the value. For detailed information about the HDCP modes see the [HDCP Management](#) section.

```
Output 16 settings
- Encryption      -
- <Always         >-
TPG mode
```

The **Test pattern generator** makes it simple to test and troubleshoot video hook-ups and displays. Use the left ◀ and right ▶ buttons to change the value. **On** turns on, **Off** turns off the test pattern generator. If it is off, the output gives a solid black, 480p video signal. (This is the default value.) In the case of **No signal mode** the output does not give any signal. #nosyncscreen #testpattern

```
Output 16 settings
  Auto
- TPG mode        -
- <on             >-
```

Three options can be selected for the resolutions of the TPG: **480p 60Hz**, **576p 60Hz** and **Odd p. signal**. Odd p. signal means the resolution of the test pattern is the same as the closest smaller or equal odd input's resolution. (Input 1 for the input 1 and 2, Input 3 for input 3 and 4, and so on...) If there is no video signal on the odd input, the generator gives a 480p signal.

```
Output 3 settings
  On
- TPG clk         -
- <Odd P. Signal >-
```

The pattern can be **solid green**, **blue**, **black**, **white** or **black and white ramp** and **chessboard** or **color bar**. The **cycle** changes all the listed ones periodically.

```
Output 3 settings
  Odd P. Signal
- TPG pattern     -
- <Color bar     >-
```

The laser on each output port can be enabled or disabled. Disabling unused laser outputs can lengthen their lifespan. Use the left ◀ and right ▶ buttons to change the value. The remote serial communication feature can be enabled or disabled.

```
Output 16 settings
- Laser enable    -
- < On            >-
```

For the RS-232 control over fiber function (see details in the [RS-232 Command Transmission](#) section) enable the **Serial Passthrough** option. It allows the serial commands to be sent over the fiber cable. It is recommended to disable this feature if not used.

```
Output 17 settings
  Color bar
  Laser enable [*]
- Serial passtr[*] -
```

### Output Port Settings Submenu (AUDIO type)

Supported board: MX-AUDIO-OB-A

Use the up ▲ and down ▼ buttons to select the parameter to be changed. Use the left ◀ and right ▶ buttons to change the value.

The submenu contains the attributes of the analog audio output signal. The available options are: **volume**, **balance**, **bass**, **treble**, **deemphasis**, **phase (inversion)**.

```
Output 1 settings
- Volume          -
- < 0 dB         >-
Balance
```

### 4.9.2.6. Hardware Status Menu

Navigate to this menu in the main menu list and press enter ◆ or right ▶ button. The monitored voltage levels, fan speeds, etc. can be scrolled through with up ▲ and down ▼ buttons. Press the escape ● button to return to the main menu.

```
- Hardware status >>

Hardware status
CPU 3.3V:  3.32V
CPU 5V:   5.03V
Battery:  2.60V
```

### 4.9.2.7. Router Status Menu

Navigate to this menu in the main menu list and press enter ◆ or right ▶ button. This view is shown by default after powering on the LDC. Matrix serial number, current IP address, TCP/IP port, and the RS-232 baud rate is shown. Press the escape ● button to return to the main menu.

```
- Router status >>

Name: 11410200
IP 192.168.002.105
Port: 10001
RS-232: 57600.8.N.1
```

### 4.9.2.8. Card Information Menu

Navigate to this menu in the main menu list and press enter ◆ or right ▶ button.

```
- Card information >>
```

The installed I/O board types can be checked. Navigate to a slot with up ▲ and down ▼ buttons, and then press enter ◆ or right ▶ button to see the board information for the selected slot. Press the escape ● button to return to main menu.

```
Card information
- Motherboard    >>
  CPU card
  Input slot #1
```

The product name and version is shown of the installed board in the selected slot. Press the escape ● button to return to the previous menu.

```
Input slot #1
MX-DVID-IB
SCH: 2.0
PCB: 2.0
```

### 4.9.2.9. Firmware Versions Menu

Navigate to this menu in the main menu list and press enter ◆ or right ▶ button. #firmwareversion

```
- Firmware versions >>
```

The current firmware version can be checked for each controller module. Use the up ▲ and down ▼ buttons to scroll through modules. Press the escape ● button to return to the main menu.

```
Firmware versions
CPU: 3.4.9r
Web server: 4.0.0
Web content: 1.7.2
```

### 4.9.2.10. Factory Reset Menu

This menu contains submenus which can reload factory defaults for certain group of settings separately. After selecting an option (submenu) with the up ▲ and down ▼ buttons, press enter ◆ or right ▶ button to execute it. Any reset operation has to be confirmed. Some operations need to reboot the matrix. Press the escape ● button to return to the main menu without any changes.

```
- Factory reset >>
```

```
- IP reset      >>
  IO card reset
  EDID reset
  HDCP key reset
```



### IP Reset Submenu

This operation reloads the factory default IP settings.

Parameter	Default value
IP address	192.168.254.254
Port number	10001
Subnet mask	255.255.0.0
Gateway	0.0.0.0

```
-IP reset >>
Reset IP settings?
-NO >>
YES
```

Select **YES** and press **enter** ◆ or **right** ► button to execute the operation. Select **NO** or press **escape** ● to return to the previous menu without any changes.

### IO Card Reset Submenu

This operation reloads the factory default settings for all input and output ports on all currently installed I/O boards. The matrix will reboot after execution.

```
-IO card reset >>
Reset IO cards?
-NO >>
YES
```

Select **YES** to execute the operation. Select **NO** or press **escape** ● to return to the previous menu without any changes.

### EDID Reset Submenu

This operation emulates the factory default F49 EDID (Universal HDMI with deep color) to all input ports on all currently installed I/O boards.

```
-EDID reset >>
Reset EDID settings?
-NO >>
YES
```

Select **YES** to execute the operation. Select **NO** or press **escape** ● to return to the previous menu without any changes.

### HDCP Key Reset Submenu

This operation clears the HDCP key cache in the matrix. This is useful when a source cannot accept as many keys as the matrix stores.

```
-HDCP key reset >>
Reset HDCP settings?
-NO >>
YES
```

Select **YES** to execute the operation. Select **NO** or press **escape** ● to return to the previous menu without any changes.

### Protocol Reset Submenu

This operation sets the Lightware communication protocol for every control interface (LAN, RS-232, USB). Beep sounds indicate protocol change.

```
-Protocol reset >>
Reset Protocols?
-NO >>
YES
```

Select **YES** to execute the operation. Select **NO** or press **escape** ● to return to the previous menu without any changes.

### All Reset Submenu

This operation resets all the settings mentioned above. The matrix will reboot.

```
-All reset >>
Reset all settings?
-NO >>
YES
```

Select **YES** to execute the operation. Select **NO** or press **escape** ● to return to the previous menu without any changes.

### 4.9.2.11. HDCP Keycounter Menu

This menu allows to test source devices how many HDCP keys they can accept. Select the input port with the **up** ▲ and **down** ▼ buttons, which the tested device is connected to, and then press **enter** ◆ or **right** ► button to execute the key-counter test. Press the **escape** ● button to return to the main menu.

```
-HDCP keycounter >>
HDCP keycounter
-Input 7 >>
Input 8
Input 17
```

The availability of this test depends on the input port type. The menu lists only those ports which are capable to run this test (HDMI or DVI-HDCP inputs).

```
-----
!Trying ## keys... !
!25% !
-----
```

A message appears showing the test progress. It can take several minutes to complete.

```
-----
!Finished !
!Result: 16 keys !
-----
```

After the test is finished, the result is shown. Press **enter** ◆ to acknowledge the result and return to the previous menu.

### 4.9.2.12. View Log Menu

Navigate to this menu in the main menu list and press **enter** ◆ or **right** ► button.

```
-View log >>
Log entries
1/8 Notice
BOOT
P:0x03 o:1
```

System events and errors can be checked in this menu. Use the **up** ▲ and **down** ▼ buttons to scroll between the log entries. The first line of each log entry shows the current entry number, the number of all entries, and the level of the current entry. The second line is the name of the event that created the entry. The third line shows a hexadecimal parameter and an occurrence counter. The occurrence shows how many times the event happened since the last startup.

```
Log entries
7/8 Error
FANSPEED
P:0x01 o:3
```

Level	Description
Notice	Not an error. Initialization information.
Warning	Possible problem without influencing normal operation.
Matter	Problem that may lead to further errors.
Error	Serious error. Must report to Lightware support.
Fatal	Fatal error. Normal operation is not possible.

See more details in the [Error Handling](#) section. Press **escape** ● to return to the main menu.

INFO: This log can contain NOTICES and WARNINGS under normal operation. These entries do not mean that there is any problem with the matrix!

### 4.9.2.13. Switch In## Out## Menu

The numbers shown in the name of this menu depend on the router frame. **Switch In17 Out17** appears for MX-FR17, and **Switch In33 Out33** appears for MX-FR33, MX-FR33L, and MX-FR33R. For MX-FR9 and MX-FR80R and MX-FR65R this menu is disabled.

```
-Switch In17 Out17>>
Press UP:
Test input [ ]
Press DOWN:
Preview output [*]
```

Navigate to this menu in the main menu list and press **enter** ◆ or **right** ► button. This menu allows to switch the Test input and Preview output ports from the front panel. These ports do not have a dedicated button with backlight like other I/O ports.

Use the **up ▲** button to select the Test input port and the **down ▼** button to select the Preview output port. The checkboxes act like the backlight for the illuminated I/O port buttons. If the asterisk appears next to the port name, it means that it is selected.

This menu is activated for three seconds every time when an I/O button is pressed on the front panel. Also, this menu appears automatically when the **AUTOTAKE** mode is activated. This gives quick access to the Test input and Preview output ports without navigating to this menu. However, if this menu is selected manually from the main menu list, it remains active until the **escape •** button is pressed.

### Input #80 Menu

This menu only appears in FR80R and FR65R frames.

Navigate to this menu in the main menu list and press **enter ◆** or **right ►** button.

```
- Input #80 >>
Input #80
<Test input >
```

The 80th port of the crosspoint can be selected to use the Test input port from the CPU board or the 8th port from the 10th input board.

**INFO:** The 80th input port of the crosspoint is multiplexed between the Test input port and the 8th port of the 10th input board. This switch is independent from the crosspoint state. The selected port (Test input or Input board #10) will be available as the 80th input on the crosspoint switch.

### Config Backup Menu

Navigate to this menu in the main menu list and press **enter ◆** or **right ►** button.

The full matrix configuration including every port setting and EDIDs can be saved and reloaded later.

To save the current configuration select **Save config now!** and press **enter ◆** or **right ►** button. A confirmation message appears then the progress starts. A status indicator shows the progress. This may take up to 1 minute. After the saving finished a message appears: 'Ready! 20160803-1411.cfg'

```
- Config backup >>
Config backup
- Save config now! >>
Config to load:
20160803-1411
```

```
Saving config!
14% ready
```

The configuration file name includes the date and time when the configuration was saved in YYYYMMDD-HHMM format. For example, the file 20160803-1411.cfg was saved at 14:11 on 3rd August, 2016.

```
Config backup
Save config now!
- Config to load: -
< 20160803-1411 >
```

To reload a previously saved configuration go to **Config to load** item with the **up ▲** and **down ▼** buttons and then select the desired configuration file with the **left ◀** and **right ▶** buttons. Press **enter ◆** to reload the selected configuration. Please note this will change every setting in the matrix (I/O port parameters, crosspoint presets, EDIDs, etc.) and the previous state could be restored only if the configuration was saved earlier.

```
Load config file?
NO
- YES >>
```

```
Loading - 82%
Don't turn off!
```

A confirmation message appears then the progress can be started. This may take several minutes. A status indicator shows the progress. After the configuration reloading finished a message appears: 'Ready!' and the matrix reboots.

**ATTENTION!** The matrix must not be switched off during a configuration reload process! If the power goes off then the matrix will restart with factory default settings.

### 4.9.3. LCD Menu Pop-up Messages

#### ALERT Screen

This pup-up screen appears when a high-level error occurs in the matrix. Press the **enter ◆** button to dismiss this alert and jump to the system log entry. Use the **up ▲** and **down ▼** buttons to scroll between the log entries. Please contact [support@lightware.com](mailto:support@lightware.com).

```
-----
!ALERT!
!FANSPEED
-----
```

```
Log entries
7/8 Error
FANSPEED
P:0x01 o:3
```

### 4.9.4. EDID Mode

To enter or to exit from this mode press and release the **EDID** button. EDID mode is active when the EDID button is illuminated on the front panel. All EDIDs are referred with their memory location e.g. F49 or D03, see the [EDID Menu](#) section. #edid

Select menu items with **up ▲** and **down ▼** buttons and then press **enter ◆** or **right ►** button to step in submenus. Press the **escape ●** button to return to main EDID management menu.

```
EDID management
-View EDID      >>
 Save EDID
 Switch EDID
```

INFO: Not executed operation is canceled when exit from the EDID menu.

INFO: Source and destination buttons are disabled while EDID mode is active.

#### View EDID Menu

All the stored EDIDs can be checked through this menu. The EDID types are grouped in submenus.

```
View EDID
-Dynamic EDIDs >>
 Emulated EDIDs
 Factory EDIDs
```

The most important information about each EDID is shown in the submenu.

```
Dynamic EDIDs
<EDID mem: D15 >
PHL Philips 230W5
1920x1200@59.94Hz
```

Use the **left ◀** and **right ▶** buttons to select the desired EDID. The monitor name and the preferred resolution can be checked.

#### Save EDID Menu

The EDID from any connected monitor can be saved to user memory slots. Select the dynamic EDID of the output port with the **left ◀** and **right ▶** buttons. Then press **down ▼** and select the user EDID slot where the monitor's EDID would be stored.

```
EDID Save
<Dynamic EDID D6 >
 to User EDID U2
 Save!
```

After the desired dynamic EDID and user memory is selected, go to **Save!** and press the **enter ◆** or **right ▶** button to store the EDID.

```
EDID Save
Dynamic EDID D6
 to User EDID U2
-Save! >>
```

### Switch EDID Menu

The emulated EDIDs can be changed in this menu. Dynamic, User or Factory EDIDs can be selected in the top row with the **left ◀** and **right ▶** buttons. The preferred resolution of the selected EDID is shown in the second row of the screen.

```
<Switch EDID: F21 >
LWR D1600x1200@60
 to input: 4
 Do switch!
```

Press **down ▼** and then select the input port with the **left ◀** and **right ▶** buttons.

```
Switch EDID: F21
LWR D1600x1200@60
 to input: 4
-Do switch! >>
```

After the desired EDID and input port is selected, go to **Do switch!** and press **enter ◆** or **right ▶** button to change the emulated EDID.

The **Operation in progress** message appears on the LCD. If switching the EDID succeed then **Operation done!** message is shown for 2 seconds.

### 4.9.5. Signal Present Mode

Press the **Signal present** button to enter or exit this mode. The Signal present mode is active when the button is illuminated.



In this mode the source and destination buttons show the actual connection state of the corresponding port, and the actual crosspoint state can be checked on the LCD menu.

Press **up ▲** or **down ▼** buttons to navigate between the submenus and screens.

**ATTENTION!** Source and destination buttons are disabled while Signal Present mode is active.

#### Source and Destination Buttons

If a source button is illuminated then a signal is present on that source. If a destination button is illuminated then a powered display is attached to this output (Hot Plug Detect signal is present).

INFO: Keep in mind that I/O boards have different capabilities to sense signals and monitors, therefore this function could be inadequate with certain I/O boards.

TIPS AND TRICKS: You can quickly check the cable connections by this feature.

### Signal on Test Input

This screen shows the actual incoming signal resolution on the Test input port.

Press **up ▲** or **down ▼** button to go to the previous or next screen.

```
Signal Present
Test input:
1600x1200@60
```

### Signal on Preview Output

This screen shows the actual signal resolution that presents on the Preview output port.

Press **up ▲** or **down ▼** button to go to the the previous or next screen.

```
Signal Present
Preview output:
no signal
```

### Crosspoint Status

Navigate to the Crosspoint submenu item with **up ▲** and **down ▼** buttons and then press **enter ◆** or **right ▶** button to step in this submenu.

```
Crosspoint status
o01i03 o02i 12 o03i 12
o04i12 o05i 12 o06i 12
o07i 12 o08i 12 o09i 12
```

The crosspoint connections are shown. One screen shows connected inputs for nine outputs. Further outputs can be checked by scroll through screens with **up ▲** and **down ▼** buttons.

Every output's connection is shown like this: 'o01i03'. In this example, it means that input 3 is connected to output 1.

Press the **escape ●** button to return to the main Signal present menu.

## 4.10. Remote Operation

Lightware matrix routers can be controlled through various interfaces remotely. The feature allows functions which are not accessible via the front panel and useful for system integrators and operators to control multiple devices in a complicated system through a single user interface.

### 4.10.1. Control Interfaces

The user can connect to the matrix through

- Ethernet (TCP/IP),
- Serial port (RS-232 or RS-422),
- USB (if available on the matrix frame front panel)

After establishing the connection, there is no difference between the connection types (except the RICOD and some rare cases, which are uniquely noted).

The RICOD enables only switching inputs, locking and unlocking device's buttons.

The available remote connections and the relating chapters are listed below.

User Interface	Connection Type			Further Information
	Ethernet Port	RS-232 Serial Port	USB Port	
Built-in website	✓	-	-	Chapter 5
Lightware Device Controller software	✓	✓	✓	Chapter 6
Third party control system	✓	✓	-	Chapter 7

**ATTENTION!** Ethernet port can be connected to a LAN hub, switch or router with a UTP patch cable. If connecting to a computer directly, a cross-link UTP cable has to be used!

### User Interface Comparison

The built-in website and Lightware Device Controller have similar capabilities. Differences and features are described in below table.

\* The feature is not supported in the case of Apple Safari browser.

Function	Lightware Device Controller Software	Built-in Website
Platform	Windows, Mac OS X	Mozilla Firefox, Apple Safari, Google Chrome
Installation	installation required	web browser needed only
I/O crosspoint switch	✓	✓
I/O and preset names	✓	✓
I/O port properties	✓	✓
Preview presets	✓	✓
Easy EDID creator	✓	✓
EDID editor	✓	✓
EDID load / save	✓	✓*
View error log	✓	✓
FW upgrade of TPS boards	✓	✓

### 4.10.2. Multiple Simultaneous Connections

The matrix allows simultaneous remote control over multiple interfaces. External control over Ethernet, Serial and USB connections can be used at the same time. Moreover, the Ethernet interface can handle multiple connections on the same TCP/IP port.

The responses to the commands are only sent to the interface on which they were queried – except responses to crosspoint switch, mute/unmute, lock/unlock and preset setting commands, which are always sent. The feature allows to operate more controllers without interfering each other but keeping the crosspoint state synchronized. If different protocols are used, then the responses to crosspoint commands are translated to the proper form.

Please note that however the matrix routers can accept multiple connections from LAN, the incoming sockets are treated as one connection, hence all messages sent by the MX-CPU2 to the LAN interface are copied to every connected client.

### 4.10.3. IP Settings

The Ethernet port can be configured on the front panel LCD menu or remotely through Controller software or the built-in website.

The factory default IP settings or DHCP mode can be activated quickly through front panel shortcut buttons. To reset the IP configuration perform the following:

#### Resetting the IP Address

Reset to factory default IP configuration or to DHCP mode with front panel buttons.

**Step 1.** Switch the router to **TAKE** mode if used previously in **AUTOTAKE** mode by pressing **TAKE** button for 3 seconds (light will go off).

**Step 2.** Press and hold down the **Control Lock** button for 3 seconds (Control Lock button lights in up red continuously).

**Step 3.** Press and keep pressed the **Output Lock** button (the current protocol indication will light up).

**Step 4.** Press and release the

a) **Load Preset** button to set the factory default IP settings:

- IP address: 192.168.254.254
- port number: 10001
- subnet mask: 255.255.0.0
- gateway: 0.0.0.0

b) **Save Preset** button to set DHCP enabled:

- IP address: Acquired with DHCP
- port number: unchanged
- subnet mask: Get from DHCP server
- gateway: Get from DHCP server

**Step 5.** A light sequence will occur to confirm the command. (Take/Auto, Load Preset and Save Preset buttons will light up one after the other)

**Step 6.** Wait about 5 seconds before connecting the router via Ethernet.

### 4.10.4. Serial Port Settings

MX-CPU2 can be ordered with either RS-232 or RS-422 communication port. The port settings are done in the factory. The device uses standard RS-232 interface with the following default settings:

**57600 Baud, 8 data bit, 1 stop bit, no parity**

The serial port baud rate can be changed on the front panel LCD menu or remotely by protocol command as well.



### 4.10.5. Control Protocols

Matrix routers can be controlled with multiple control protocols. Lightware routers have a special protocol, but to inter-operate with third-party devices, a secondary protocol is also provided.

**ATTENTION!** Be aware that different control interfaces can be set to use different protocols. E.g. Lightware protocol is set on Ethernet interface while Protocol #2 is set on the Serial interface at the same time. Lightware Device Controller software and the built-in website works only with LW protocol (#1)!

**INFO:** The communication protocol of the USB interface (Lightware protocol) cannot be changed.

The currently used protocol can be viewed or changed any time on the matrix front panel or by protocol commands.

#### Changing (displaying) the Current Protocol on the Front Panel

**Step 1.** Switch the router to **TAKE** mode; if **AUTOTAKE** mode was active press the **TAKE** button for 4 seconds. (light will go off)

**Step 2.** Press **Control Lock** button for 3 seconds (it lights in up red continuously)

**Step 3.** Press and keep pressed the **Output Lock** button, the button will light in red. Now the active protocols for the Serial and the Ethernet ports are displayed (view protocol):

- a) One **source** button lights up according to the current protocol on the Serial port:
  - **Source#1** lights: Lightware protocol active on Serial
  - **Source#2** lights: Protocol#2 is active on Serial
- b) One **destination** button lights up according to the current protocol on the Ethernet port
  - **Destination#1** lights: Lightware protocol active on Ethernet
  - **Destination#2** lights: Protocol#2 is active on Ethernet
- c) The LCD on the front panel shows the active protocols for each interface as well.

**Step 4.**

- a) Release the **Output Lock** button to keep the current protocol.
- b) If you want to change the protocol on any interface, keep the **Output Lock** button pressed, and press the desired **Source** or **Destination** button, accordingly to the new protocol for that specific interface.

**Step 5.** If the control protocol for any interface has changed then a beep will sound to notify the change.

### Changing (displaying) the Current Protocol via Remote Connection

Connect to the matrix through any control interface, then use the commands described in the [Changing the Control Protocol](#) section.

### 4.11. Error Handling

The MX-CPU2 can detect and log many system events. Every log entry gets a time stamp based on the CPU real time clock. These events are categorized by levels.

Level	Description
<b>Notice</b>	Not an error. Initialization information.
<b>Warning</b>	Possible problem without influencing normal operation.
<b>Matter</b>	Problem that may lead to further errors.
<b>Error</b>	Serious error. Must report to support.
<b>Fatal</b>	Fatal error. Normal operation is not possible.

The matrix router saves error logs on the built-in micro SD memory card. These log files can be downloaded and viewed with the controller software.

The error log entries have an error level, time, error code, error parameter, processor task identifier, occurrences and extra information.

The device creates a new error log file every time it is started except if there is already a log file created for that day. The software allows to select only months and days which have a log.

The matrix can indicate if an error occurred in several ways:

- **Show alert** on the front panel LCD
 

```
! ATTENTION !
Please check log in
Device Controller
ENTER=View ESC=Exit
```
- **Send protocol messages** when errors occur. The levels for which this immediate message is sent out can be changed by protocol command.
- Indicate with **ALERT LED** and **SMPTE alarm output** on the MX-CPU2 board. If the Alarm LED was triggered it remains lit until the frame is rebooted.

The default levels which trigger an alarm for the specific method are shown below:

Level	Name	LCD Alert	LED, SMPTE	RS-232, LAN
<b>0</b>	NOTICE	-	-	-
<b>1</b>	WARNING	-	-	-
<b>2</b>	MATTER	-	yes	yes
<b>3</b>	ERROR	yes	yes	yes
<b>4</b>	FATAL	yes	yes	yes

**INFO:** This log can contain NOTICES and WARNINGS under normal operation. These entries do not mean that there is any problem with the matrix!

#### Low Battery Alert

The warning shows that the battery on the CPU board is exhausted or not inserted. The function of the battery is powering the real time clock when the frame is powered down. The low battery does not affect normal operation of the matrix. However the error log will not have correct time stamps.

#### Replacement Steps

**Step 1.** Switch off the matrix and take out the MX-CPU2 board. Locate the battery holder. Check if the battery is contacting well in the holder.

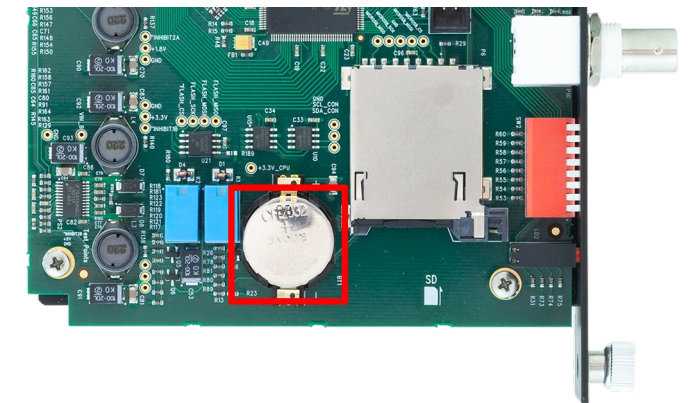

**Step 2.** Take the battery out firmly taking care not to bend the spring contact upwards. Bend the spring contact a little bit downwards to ensure good contact.

**Step 3.** If the battery is exhausted, replace with lithium button battery type CR2032.

# 5

## Software Control - The Built-in Web

The MX-CPU2 board has a feature which allows to connect and control the matrix via a web browser. The range of the controlling features are not so wide as in the case of Lightware Device Controller, but numerous information is displayed and many settings are available.

- ▶ [SYSTEM REQUIREMENTS](#)
- ▶ [ESTABLISHING THE CONNECTION](#)
- ▶ [THE LAYOUT OF THE BUILT-IN WEB](#)

### 5.1. System Requirements

**Supported Operating Systems:** Microsoft Windows XP, Windows Vista, Windows 7, Windows 10, mac OS X, Linux.

**Supported Web Browsers:** Mozilla Firefox, Google Chrome, Apple Safari.

### 5.2. Establishing the Connection

**ATTENTION!** If the connection is made through the router's Ethernet port, be sure that the computer is in the same network as the router. If the computer has multiple Ethernet connections (e.g. wired and wireless) you will have to know the IP address for the one that is used for controlling the matrix.

#builtinweb #web

- Step 1.** Connect the matrix and the computer either via
- Ethernet, with LAN patch cable (to a hub, switch or router), or
  - Ethernet, with LAN cross cable (directly to a computer).
- Step 2.** Change to the desired IP settings if it is needed.
- Step 3.** Type the IP address to the address bar of the web browser and press enter (factory default address is 192.168.254.254).

### 5.3. The Layout of the Built-in Web

The built-in web page allows almost the same controlling functions which are available via the Lightware Device Controller.

**ATTENTION!** Only one web page is allowed to open simultaneously to the same matrix. Other TCP/IP connections are prohibited.

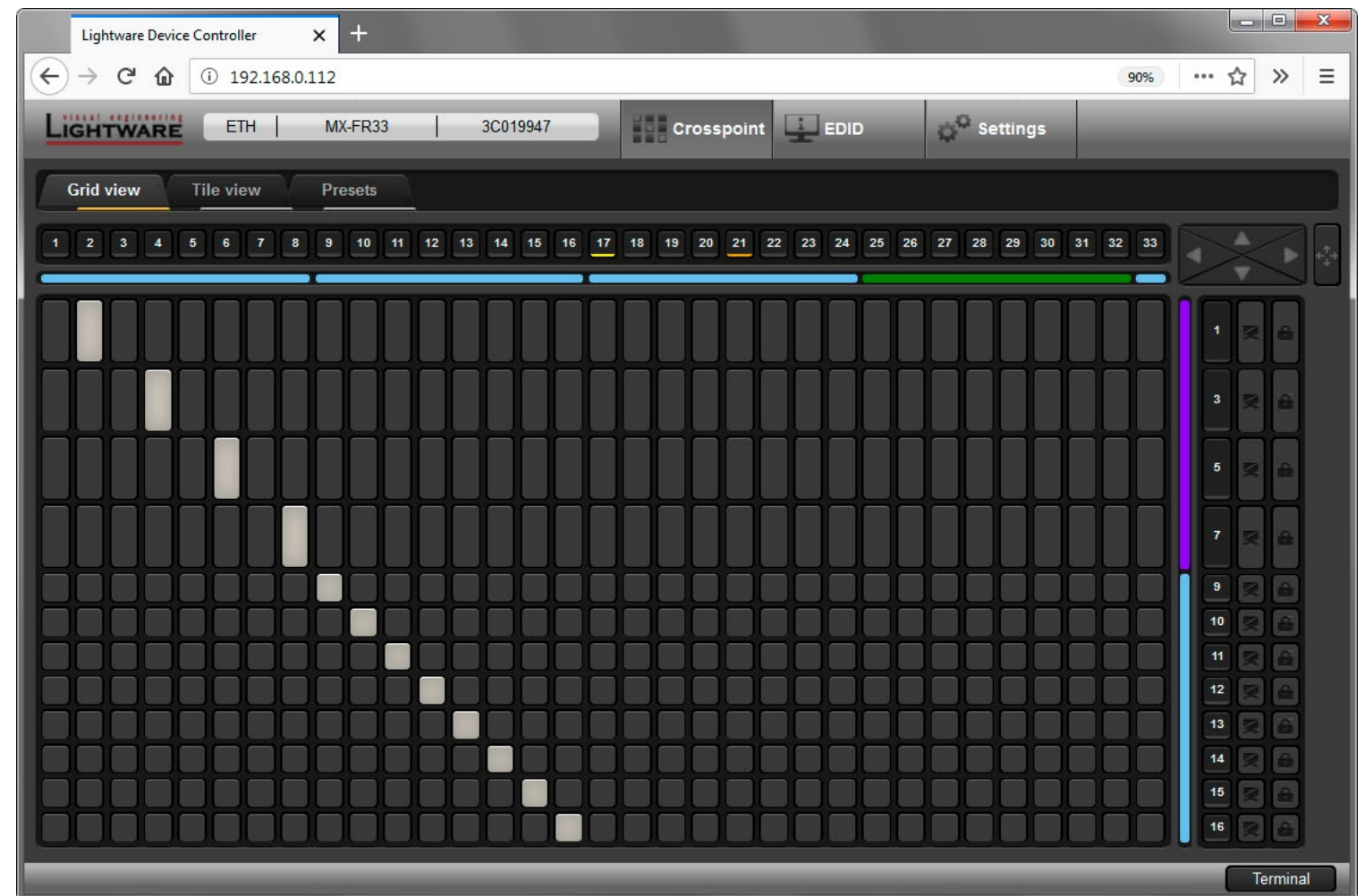

# 6

## Software Control – Lightware Device Controller Software

The matrix can be controlled by a computer through the USB, RS-232, and Ethernet port using Lightware Device Controller (LDC). The software can be installed on a Windows PC or mac OS X. The application can be downloaded from [www.lightware.eu](http://www.lightware.eu). The Windows and the Mac versions have the same look and functionality.

- ▶ [INSTALL AND UPGRADE](#)
- ▶ [RUNNING THE LDC](#)
- ▶ [CONNECTING TO A DEVICE \(DEVICE DISCOVERY WINDOW\)](#)
- ▶ [CROSSPOINT MENU](#)
- ▶ [PORT PROPERTIES AND SETTINGS](#)
- ▶ [EDID MENU](#)
- ▶ [SETTINGS MENU](#)
- ▶ [TERMINAL WINDOW](#)

**TIPS AND TRICKS:** To get the best visibility of the screenshots in this chapter adjust the zoom setting of your PDF Reader software to 150% magnification.

### 6.1. Install and Upgrade

**INFO:** After the installation, the Windows and the Mac application has the same look and functionality. This type of the installer is equal with the Normal install in case of Windows and results in an updateable version with the same attributes.

#### Installation for Windows OS

Run the installer. If the User Account Control drops a pop-up message click Yes. During the installation you will be prompted to select the type of the installation: normal and the snapshot install:

Normal install	Snapshot install
Available for Windows and mac OS X	Available for Windows
The installer can update only this instance	Cannot be updated
Only one updateable instance can exist for all users	More than one different version can be installed for all users

*Comparison of the Installation Types*

**ATTENTION!** Using the Normal install as the default option is highly recommended.

#### Installation for mac OS X

Mount the DMG file with double clicking on it and drag the LDC icon over the Applications icon to copy the program into the Applications folder. If you want to copy the LDC into another location just drag the icon over the desired folder.

#### The Upgrading of the LDC

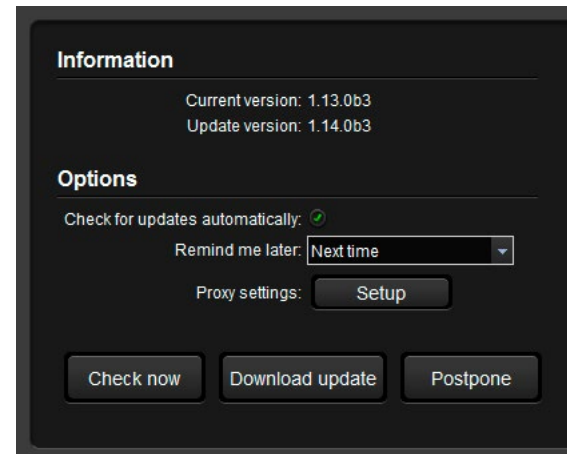

#### Step 1. Run the application.

The **Device Discovery** window appears automatically and the program checks the available updates on Lightware's website and opens the update window if LDC updates are found. The current and the update version number can be seen at the top of the window and they are shown in this window even with the snapshot install. The **Update** window can be also opened by clicking the **?** (About) and the **Update** button.

#### Step 2. Set the desired update setting in the Options section.

When the Check for updates automatically option is selected, the LDC tries to find a new version after startup. The update can be postponed by setting a reminder; use the drop down list. The proxy settings can be set in a separate window.

#### Step 3. Click the Download update button to start. The updates can be checked manually by clicking the Check now button.

### 6.2. Running the LDC

The common way to start the software is double-click on the LDC icon. But the LDC can be run by command line parameters as follows:

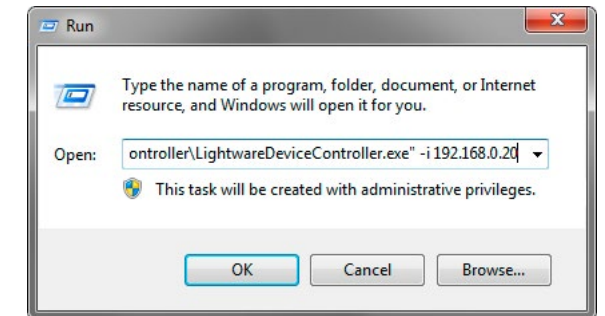

#### Connecting to a Device with Static IP Address

**Format:** LightwareDeviceController -i <IP\_address>:<port>

**Example:** LightwareDeviceController -i 192.168.0.20:10001

The LDC is connected to a device with the indicated static IP address directly; the Device Discovery window is not displayed. When the port number is not set, the default port is used: 10001 (LW2 protocol). For LW3 devices use the 6107 port number.

#### Connecting to a Device via a Serial Port

**Format:** LightwareDeviceController -c <COM\_port>:<Baud>

**Example:** LightwareDeviceController -c COM1:57600

The LDC is connected to a device with the indicated COM port directly; the Device Discovery window is not displayed. If no Baud rate is set the application will detect it automatically.



### 6.3. Connecting to a Device (Device Discovery Window)

There are three tabs for the different type of interfaces: Ethernet, Serial, and USB.

The Ethernet tab consists of two lists:

- **Favorite devices:** You can add any Lightware device that is connected via Ethernet and no need to browse all the available devices.
- **All devices:** The Lightware devices are listed which are available in the network.

#### Further Tools

The Tools menu contains the following options:

- **Log viewer:** The tool can be used for reviewing previously saved log files.
- **Create EDID:** This tool opens the Easy EDID Creator wizard which can be used for creating unique EDIDs in a few simple steps. Functionality is the same as the Easy EDID Creator, for the detailed information see the [Creating an EDID](#) section.
- **Demo mode:** This is a virtual MX-FR17 matrix router with full functionality built into the LDC. Functions and options are the same as a real MX-FR17 device.

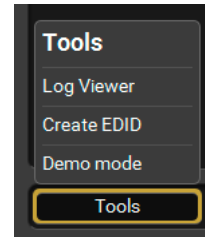

The Terminal window is also available by pressing its button on the bottom.

#### Establishing the Connection

Select the unit from the discovered Ethernet devices or under USB devices; when the device is connected through RS-232 click on the Query button next to the desired serial port to display the device's name and serial number. Double click on the device or select it and click on the green Connect button.

**ATTENTION!** When the device is connected via the local RS-232 port, make sure that LW protocol (#1) is set on the serial port. The protocol settings are available on the front panel LCD menu, see the [Control Protocols](#) section.

The screenshot shows the 'Device Discovery' window with the following data:

Favorite Devices (fix IP)						
N.	IP	Port	Product name	Device label	Local alias	Serial number
1	192.168.0.91	6107			Add local alias	
2	192.168.0.101	6107			Add local alias	
3	127.0.0.1	6107			Add local alias	

All Devices					Devices found: 4	Refresh
IP	Port	Product name	Device label	Serial number		
192.168.0.20	10001	MX-FR33	MX-FR33	3C019947		★
192.168.2.204	6107	MX2-8X8-HDMI20-AUDIO	TST-ORIG	87654321		★
192.168.2.208	6107	HDMI-TPS-RX110AY	HDMI-TPS-RX110AY	00004303		★
192.168.2.59	6107	MMX4x2-HT200	RX200-newFw	00005032		★

## 6.4. Crosspoint Menu

### 6.4.1. Grid View

Grid view is a user-friendly graphical interface displaying the crosspoint state of the matrix router. This is an easy way to change between the input sources and output sinks. `#crosspoint` `#gridview` `#switch`

**TIPS AND TRICKS:** If not all the output boards are visible on the screen you can use the wheel of the mouse to scroll the output boards. The feature is available in the case of the input boards also; keep the shift button pressed when scrolling or use the secondary scroll function.

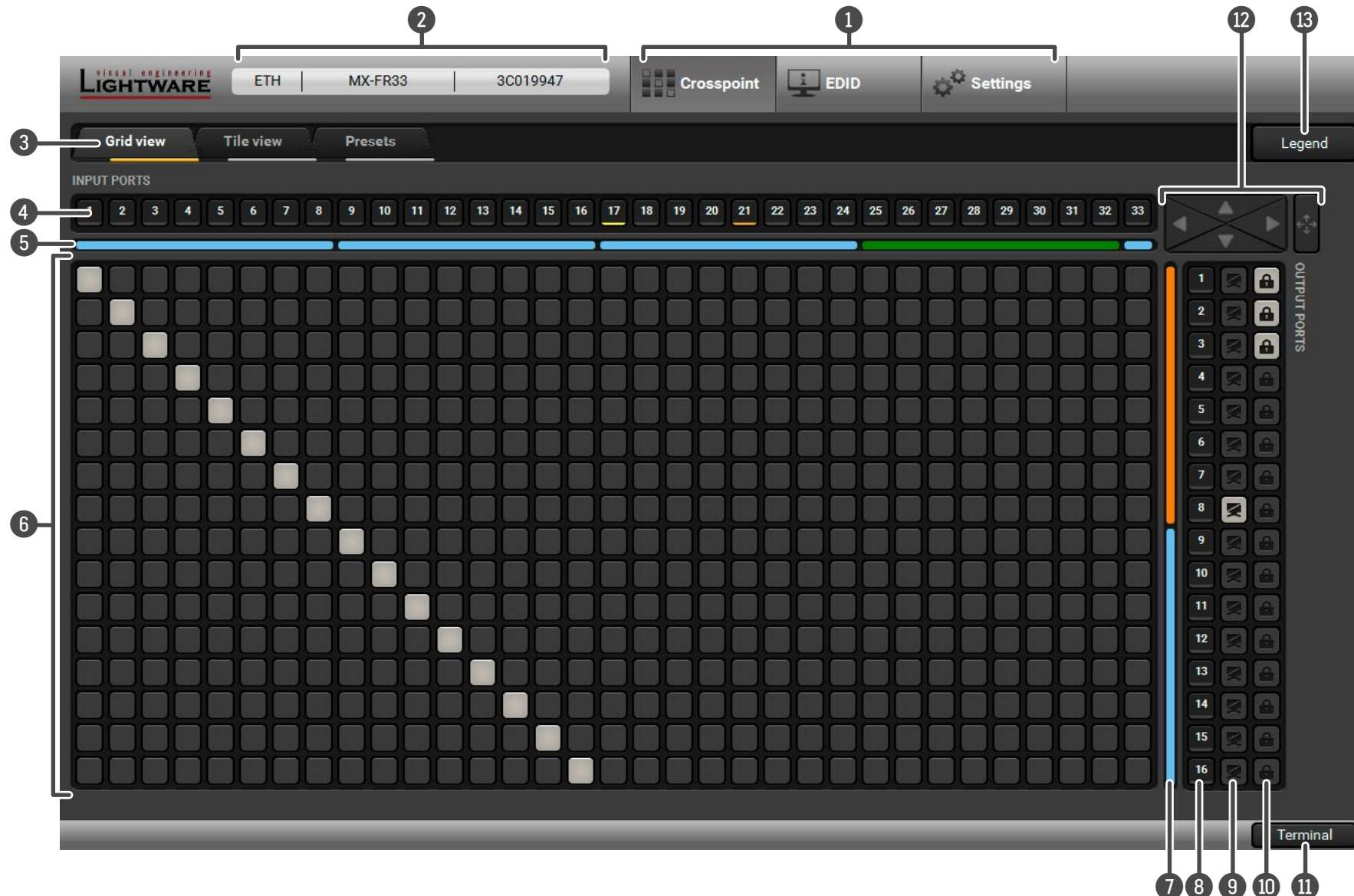

Grid View in the Crosspoint Menu of a Matrix Router

- 1 **Main Menu** The available menu items are displayed. The active one is highlighted with a dark grey background color.
- 2 **Information Ribbon** This label shows the interface type, the name and the serial number of the connected device. If the device has more than one interface, the ribbon shows only that one, which has made the connection. Click on the ribbon to open the device discovery window.
- 3 **Tab Selector Ribbon** The crosspoint and the settings menu contain more than one tab. Click on the desired one to select it. The yellow line shows which tab is the active one.
- 4 **Input Ports** Each number represents an input port. If the window size does not allow to display all the ports, pages can be turned by the left and right arrow buttons of the navigator.
- 5 **Input Boards** The color of the line shows what kind of input boards are installed.
- 6 **Connections** Dark grey square means the port is not available. Light grey square means the port is available but there is no connection. White square means there is a connection between the input and the output port.
- 7 **Output Boards** The color of the line shows what kind of output boards are installed.
- 8 **Output Ports** Each number represents an output port. If the window size does not allow to display all the ports, pages can be turned by the up and down arrow buttons of the navigator.
- 9 **Mute Buttons** Outputs can be easily muted by clicking on the mute button.
- 10 **Lock Buttons** For the prevention of the unwanted switching, outputs can be locked to any input.
- 11 **Terminal** This general-purpose terminal is created mainly for testing and debugging purposes. For more information see the [Terminal Window](#) section.
- 12 **Navigation Buttons** If the window size does not allow to display all the ports, pages can be turned by the arrow buttons of the navigator.
- 13 **Legend Button** Open the Legend panel displaying the meaning of the applied symbols and colors of the Grid view.

### 6.4.1.1. The Legend Window

MX-FR frames can be equipped with different type of boards. The colored bars below/next to the input/output ports display the type of the board in each slot. Whether it is an optical, a twisted pair or other kind of board, a different color represents its type. The status of the current port is also visible (mute/lock state, signal presence).

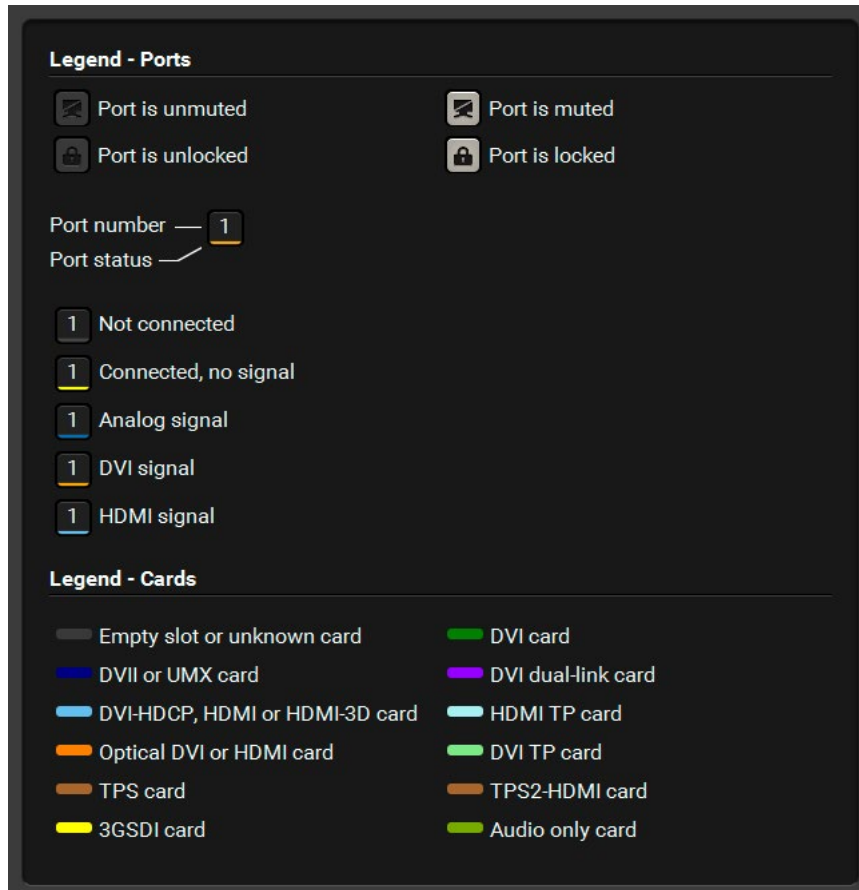

The Legend Window

### 6.4.1.2. Crosspoint Operations

#### Switching

For making a connection click on the desired square. If there is no connection between the desired input and output (the square is dark grey), the mouse pointer becomes a hand (link pointer) before the clicking. If the output port is not locked, the connection is made, the square becomes white and the cursor changes back to a pointer. `#switch`

For example, input 33 is not connected to output 2 according to the first picture below. After the connection is established the square becomes light grey.



#### Muting the Outputs

Outputs can be easily muted by clicking on the button symbolized by a crossed monitor beside the output. This means that no signal is present at this output. If mute is active, the color of the button's background changes to white. `#mute #unmute`

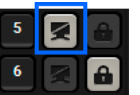

INFO: Inputs can be disconnected from any outputs (by protocol command). In this case, the crosspoint view will not show any white square for the disconnected output and the output will have no signal just like when muted. Click on a crosspoint square to connect the output again to an input.

#### Locking the Outputs

Outputs can be locked to any input. After locking an output to an input, no switching is permitted to this output unless it is unlocked again. If output lock is active, the color of the button's background changes to white. `#lock #unlock`

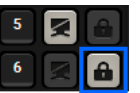

INFO: Loading a preset does not change either the lock state or the switch state of a locked output. If an output is locked to an input before preset loading it will also be locked to that input after preset loading, so locked outputs ignore the preset.



### 6.4.2. Tile View

The tile view is to display the input and output ports by tiles. Each tile means an input or output port and additionally shows the most important port and signal information. Thus, the user can check the status of many ports at the same time without clicking on a port or opening port settings window.

#### Display Modes *#tileview*

Three display modes are defined in Tile view for matrix routers:

- **View mode:** displaying the current crosspoint-state (changing is not possible but port settings are available).
- **Input switch mode:** select an input port at first then select the desired output ports.
- **Output switch mode:** select an output port at first then select the desired input port.

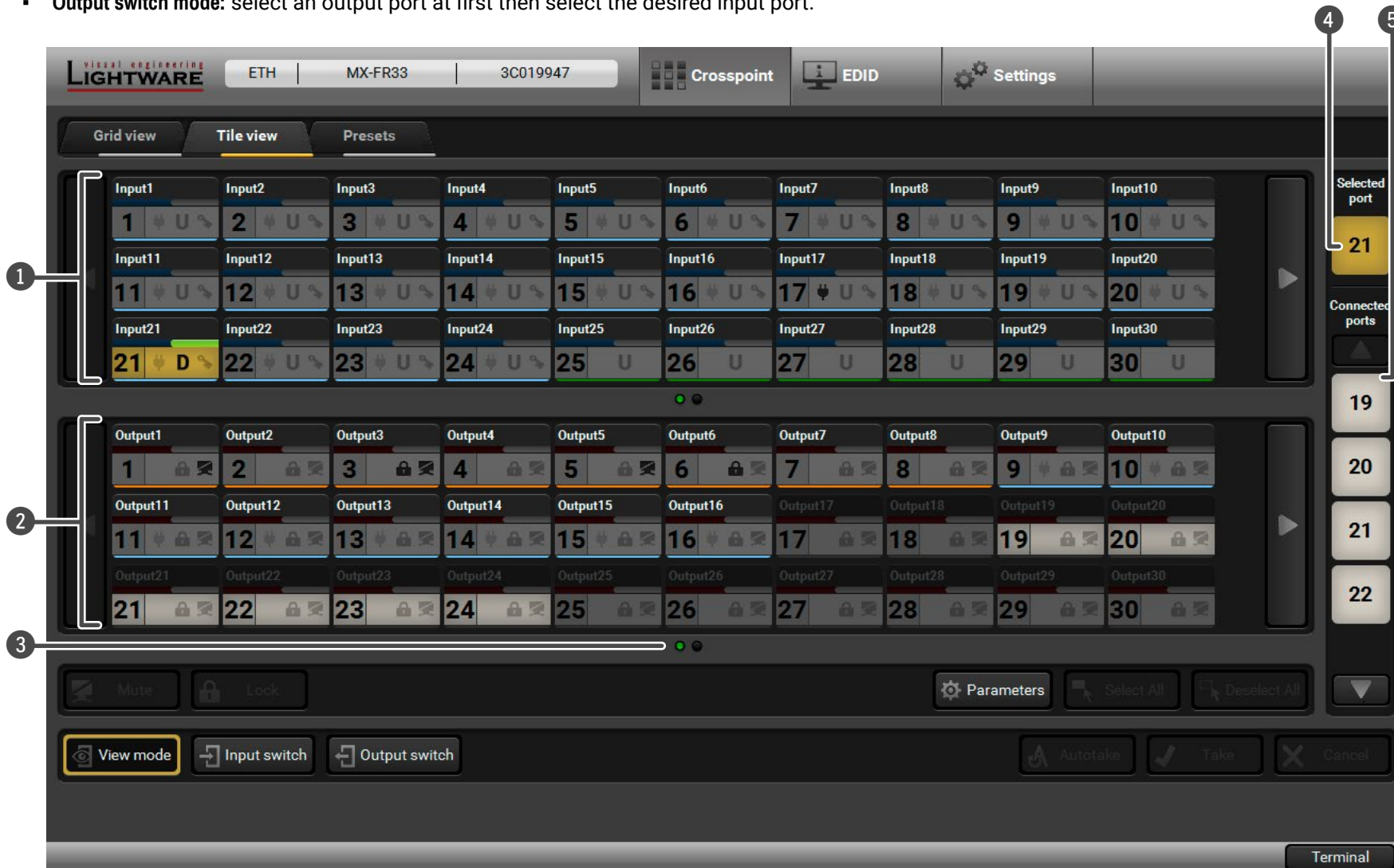

The Tile View in the Crosspoint Menu

- 1 Input Ports** Each tile represents an input port. If window size does not allow to display all the ports, pages can be turned by the left and right arrow buttons.
- 2 Output Ports** Each tile represents an output port. If window size does not allow to display all the ports, pages can be turned by the left and right arrow buttons.
- 3 Page Indicator** The number of the dots represent the page numbers if more pages are necessary to display the ports. The current page is displayed by a green dot.
- 4 Connected Port(s)** Those ports are listed (with white background) on the port bar, which are connected to the Selected port.
- 5 Selected Port** Last selected port is displayed with a yellow background on the port bar. Press the button to open the port settings window.

#### Control Buttons

- |  |               |  |
|--|---------------|--|
|  | Mute          | (Un)muting the selected output port(s)             |
|  | Lock          | (Un)locking the selected output port(s)            |
|  | View mode     | Selecting the View mode                            |
|  | Input switch  | Selecting the Input switch mode                    |
|  | Output switch | Selecting the Output switch mode                   |
|  | Parameters    | Displaying the port settings window                |
|  | Select All    | Selecting all ports (only in output switch mode)   |
|  | Deselect All  | Deselecting all ports (only in output switch mode) |
|  | Autotake      | Toggling the Autotake mode ON/OFF                  |
|  | Take          | Executing the crosspoint changes in Take mode      |

### 6.4.2.1. Port Tiles

The colors of the port tiles and the displayed icons represent different states and information:

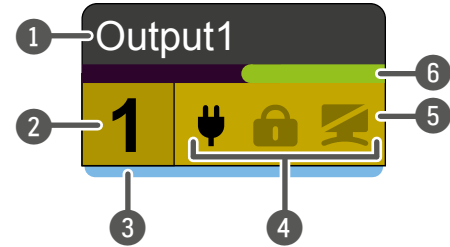

- 1 **Port name**
- 2 **Port number**
- 3 **Board type** (see [The Legend Window](#) section).
- 4 **State indicators**
- 5 **Background color**
- 6 **Signal present indicator**  
**green:** present  
**grey:** not present

#### Background Colors (Port State)

The colors of the port tiles represent different states of the port as follows:

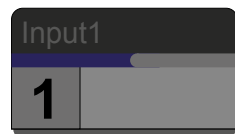

**Dark grey**  
Port is not available  
(no board is installed)

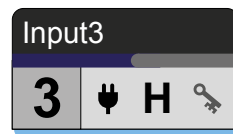

**White**  
Connected port

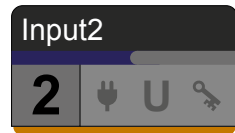

**Light grey**  
Port is available



**Yellow**  
Selected port

#### State Indicators #hdcp

Icon	Icon is not displayed	Icon is grey	Icon is black	
	No information is available about connection status	Port is available but inactive	<b>Output ports:</b> Port is available and sink is connected (hotplug detected) <b>Input ports:</b> Port is available and source is connected (power +5V detected)	
	-	Port is unmuted	Port is muted	
	-	Port is unlocked	Port is locked	
[Signal type]	No information is available	Last detected signal type is displayed	U – unknown signal D – DVI signal H – HDMI signal	A – Analog signal S – SDI signal
	HDCP is not supported	Signal is not encrypted with HDCP	Signal is encrypted with HDCP	

### 6.4.2.2. Display Modes

#### View Mode

The mode allows to display the current crosspoint-state. The crosspoint cannot be changed in this mode but port settings are available.

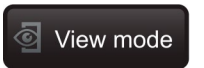

#### Input Switch Mode

The mode can also be named as 'Input priority-mode': an input port has to be selected at first then the connected output port(s) is/are shown. Thus, the output port(s) connected to the input port can be changed.



#### Output Switch Mode

This mode can also be named as 'Output priority-mode: an output port has to be selected at first then connected input port is shown. Thus, the output port connected to the input port can be changed. Output ports can be (un)locked, (un)muted only in Output switch mode.

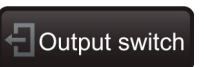

### 6.4.2.3. Crosspoint Operations

#### Switching in Take Mode #autotakemode

The black outlined **Autotake** button means this mode is active. Any crosspoint change – (dis)connecting ports to/from the previously selected port – is executed only after pressing the **Take** button. Following steps describe the process of the switching:



- Step 1.** Press the desired **Input switch** or **Output switch** button to select switching mode.
- Step 2.** Select the desired **port**; it will be highlighted with yellow color and displayed on the port bar on the right, too.
- Step 3.** Connected port(s) is/are highlighted with white color and displayed on the port bar on the right, too.
- Step 4.** Create the desired **crosspoint settings** by (de)selecting the ports; they will start to blink.
- Step 5.** Press **Take** button to execute changes or **Cancel** to ignore the operations.

**INFO:** Take mode remains active until it is switched off. Selecting another view mode or menu does not change the Take/Autotake mode state.

#### Switching in Autotake Mode

The yellow outlined **Autotake** button means this mode is active. Any crosspoint change – (dis)connecting ports to/from the previously selected port – is executed immediately after pressing the port button. Following steps describe the process of the switching:



- Step 1.** Press the desired **Input switch** or **Output switch** button to select switching mode.
- Step 2.** Select the desired **port**; it will be highlighted and displayed on the port bar on the right, too.
- Step 3.** Connected ports are highlighted with white color and displayed on the port bar on the right, too.
- Step 4.** Create the desired crosspoint settings by **(de)selecting the ports**; the changes are executed immediately.

**INFO:** Autotake mode remains active until it is switched off. Selecting another view mode or menu does not change the Take/Autotake mode state.

## 6.5. Port Properties and Settings

Press the desired port button on the port bar on the right.



**INFO:** Port settings of the selected port are also available by pressing the Parameters button.

Click on the number of the desired port in the case of grid view or on the headline of the port in the case of tile view to open the port properties window. Signal status information and the most important parameters are displayed. Audio mode, HDCP settings, properties of the test pattern are available from this menu. If analog audio is present, the user can set the volume, balance and gain values here. Special functions (e.g. frame detector, switching this input to all outputs, etc) are also available on the panel.

**ATTENTION!** As the available settings and features are different port by port the content of the Port properties window is also different.

### 6.5.1. Common Features

#### Scope of Changes

There are two options to apply changes. To set the scope of the changed settings, select the desired option.

- **Apply changes to current input:** the modified parameters are applied to the current port.
- **Apply changes to all inputs:** the modified parameters are applied to all input ports.

**INFO:** When opening the window again, the selection will be set to “Current Input” regardless of the active selection at the time of closing to avoid making changes to all inputs by mistake.

#### Reload Factory Defaults

- **Current input:** Reloads the default values to the currently selected input.
- **All inputs:** Loads the factory default values to all inputs.

#### Port Name

The port name can be changed by typing the new name and clicking the Rename button.

#### Switch this Input to all Outputs

This input will be router to all of the outputs. Before switching the actual crosspoint state can be saved as a Preset.

#### HDCP Enable (input ports)

The HDCP capability can be enabled or disabled on the input port. This can prevent unnecessary HDCP encryption with certain source devices. Note that only unprotected contents can be played on the source if this setting is disabled (unchecked). See the [HDCP Management](#) section for more information. `#hdc`

#### Input Cable Equalization

The amplitude of high-frequency signals decreases after they pass-through long distances in copper cables. To counter-act this phenomenon, certain input boards can amplify the signal while maximizing the amplitude at a certain level, which is defined by the DVI 1.0 standard. This process is called equalization.

There are two equalization modes: automatic and manual. Automatic mode usually provides perfect transmission but at longer distances and higher resolutions, manual equalization may be necessary. By default, automatic equalization is enabled.

Keep in mind that a previously set manual equalization level may not be suitable for a different system. It is always advised to use the automatic mode and adjust the equalization manually if the auto mode does not give a good result.

#### Serial Port Extension Parameters (HDMI-OPT boards)

*Supported Boards:*

- *MX-HDMI-OPT-IB, -OB, -OB-R*

This is the RS-232 commands over fiber function, which is described in the [RS-232 Command Transmission](#) section. It allows the serial commands to be sent over the fiber cable. It is recommended to disable this feature if not used. If the far optical device supports this protocol the Serial passthrough can be enabled. Click on the drop-down menu, then select the Enable option.

The Serial link shows the actual status of the function. If the function is supported by the transmitter and it is enabled the status is “Live” otherwise the “TX/RX not detected” text can be seen.

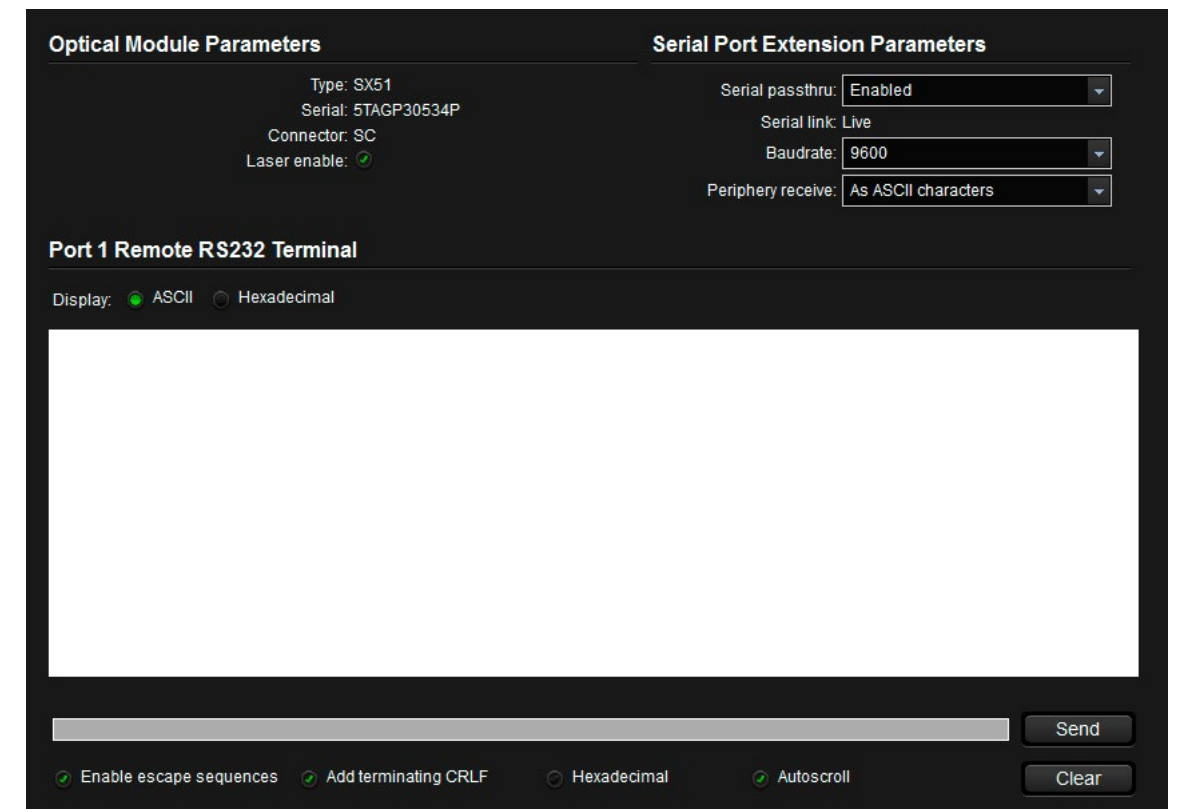

**RS-232 Terminal (MX-HDMI-OPT-OB-R-SC board)**



The **Baudrate** line contains the speed of the communication. The baud rate is determined by the TX side of a serial communication: the receiver follows the setting of the output board and the input board follows the setting of the transmitter. The **Periphery receive** determines what the incoming data will be. If it is “disabled”, the response will be ignored. The data can be sent as ASCII characters or numbers as binary data. Select the appropriate value from the list.

### RS-232 Terminal

The RS-232 commands can be sent via this terminal or protocol commands (for protocol commands see the [Programmer's Reference](#) chapter). The displayed text can be ASCII or Hexadecimal format but it affects only the visualization of the terminal text. If the typed text contains escape characters check the first checkbox. Add terminating CRLF add CarriageReturn and LineFeed after every line when the **Enter** key was hit or the **Send** button is pushed with a mouse click.

The terminal window can be cleared with the **Clear** button, but if the autoscroll checkbox is active, it shows the last commands. If the command to be sent consists hexadecimal bytes (00 .. FF) check the Hexadecimal checkbox under the input line.

### Serial Port Extension Parameters (TPS boards)

Supported Boards:

- *MX-TPS-IB, -TPS2-IB, -TPS-OB, -TPS2-OB*

The structure of the RS-232 terminal window is almost the same as in the case of the optical boards.

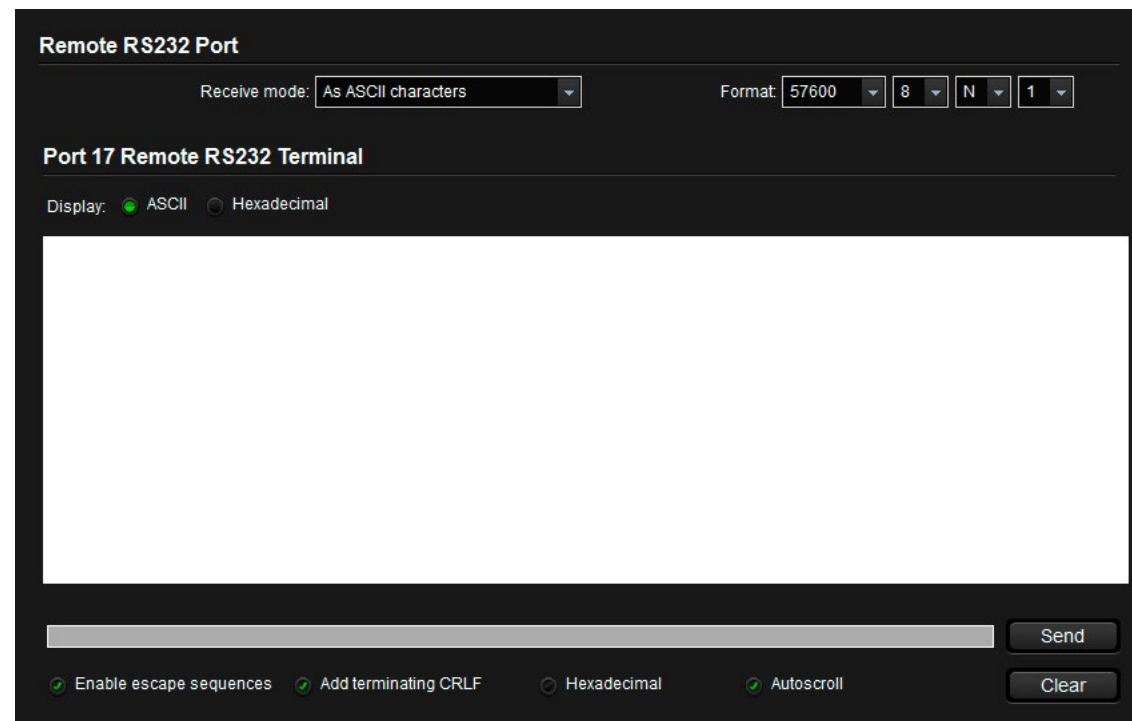

RS-232 Terminal (MX-TPS2-OB-AP board)

## 6.5.2. Diagnostic Tools

### 6.5.2.1. Frame Detector

The ports can show detailed information about the signal like blanking intervals and active video resolution. This feature is a good troubleshooter if compatibility problems occur during system installation. To access this function, open the port properties window and click on Frame detector button. `#framedetector`

Lightware's Frame Detector function works like a signal analyzer and makes possible to determine the exact video format that is present on the port, thus helps to identify many problems. E.g. actual timing parameters may differ from the expected and this may cause some displays to drop the picture.

Frame Detector measures detailed timings on the video signals just like a built-in oscilloscope, but it is much more easy to use. Actual display area shows the active video size (light gray). Dark gray area of the full frame is the blanking interval which can contain the info frames and embedded audio data for HDMI signals. Shown values are measured actually on the signal and not retrieved only from the HDMI info frames.

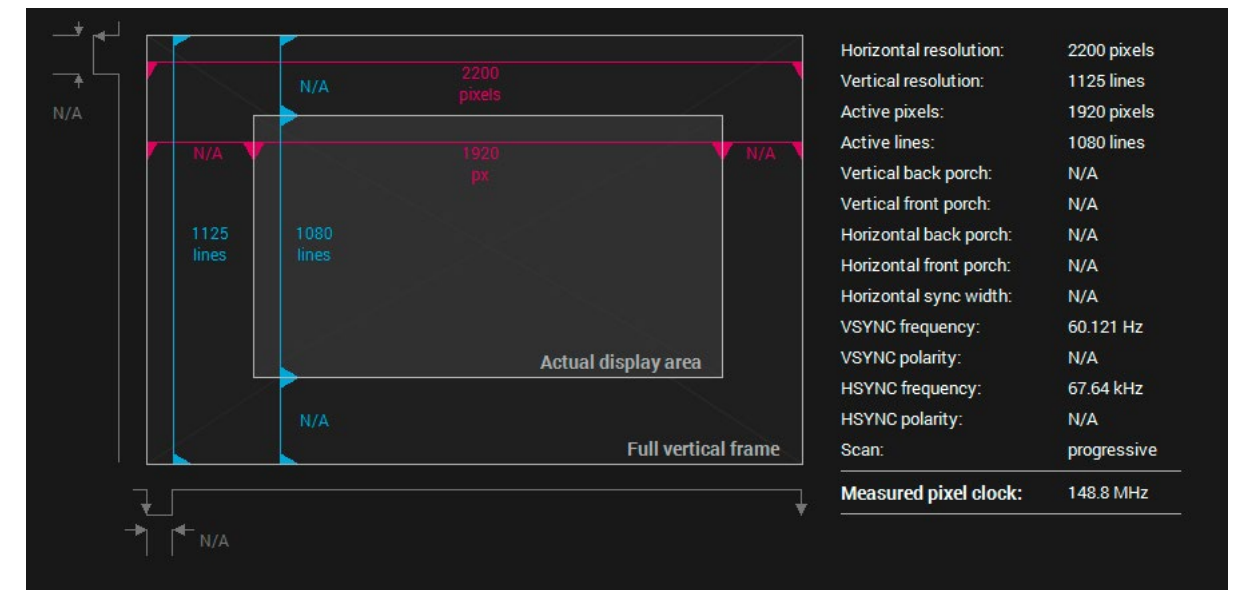

Frame Detector Window

### 6.5.2.2. TPS Cable Diagnostics

The cable diagnostics is a useful tool to determine any cable related issues in the case of TPS connection. The estimated cable length and the quality of the link are measured periodically and the diagnostic window shows the values in real-time. If the green bars hit the first line in the middle they turn into red. It means the number of the errors – during the extension – is higher than recommended. The link might be alive but recovering of the received data is not guaranteed.

INFO: Each bar represents a differential line in the CATx cable. The inappropriate termination of the cable usually causes high error rates. Check the cable terminations or change the cable.

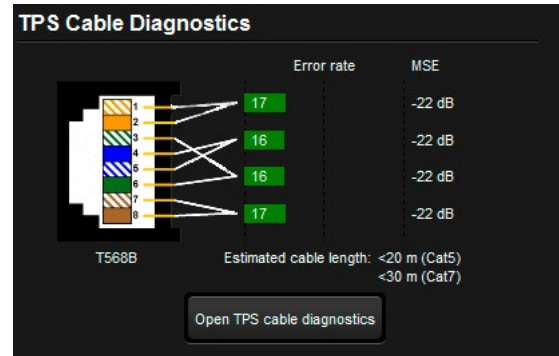

#### Reference Values

Data can be displayed in two ways: table view and chart view. Data can be exported to a file by clicking on the Export data button.

Time	Error rate #1	Error rate #2	Error rate #3	Error rate #4	MSE #5	MSE #6	MSE #7	MSE #8	Length
12:03:58	35	30	31	31	22	22	21	22	<20 m
12:03:54	32	31	31	31	22	22	22	22	<20 m
12:03:50	32	35	32	31	22	21	21	22	<20 m
12:03:46	31	30	34	31	21	22	21	22	<20 m
12:03:42	32	34	34	31	22	22	21	22	<20 m
12:03:38	34	31	35	30	21	22	21	22	<20 m
12:03:34	32	30	34	32	22	22	21	21	<20 m
12:03:30	32	30	35	32	22	22	22	21	<20 m
12:03:26	37	31	34	31	22	22	21	22	<20 m
12:03:22	32	31	34	31	22	22	21	22	<20 m
12:03:18	31	32	32	30	22	22	21	22	<20 m
12:03:14	32	31	35	32	22	22	21	22	<20 m

TPS Cable Diagnostics Window - Table View

### 6.5.2.3. Test Pattern Generator

Supported Boards: available for the most of the boards. #nosyncscreen #testpattern

The output ports can send a special image towards the sink devices for testing purposes. The setting is available on output ports with the following parameters:

#### Mode

- On: the test pattern is always sent to the output port.
- Off: the test pattern generator is off.
- No signal: the test pattern generator is switched on if no video signal is switched to the given output port.

#### Clock Source

- 480p / 576p / Original video signal: the clock frequency of the test pattern.

#### Pattern

- Red / Green / Blue / Black / White / Ramp / Chess / Bar / Cycle. Cycle setting means all the patterns are changed sequentially approx. in every 2 seconds.

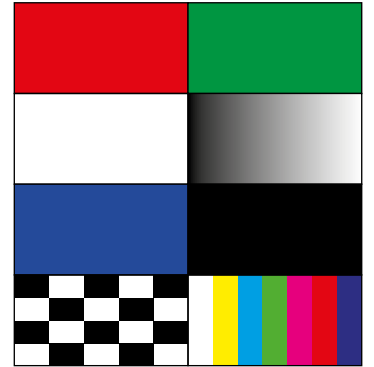

### 6.5.3. Input Port Properties

#### 6.5.3.1. HDMI-OPT Type Input Ports

Supported Boards:

- MX-HDMI-OPT-IB-LC, -SC, -NT

Input parameters of HDMI-OPT Type input port

MX-HDMI-OPT boards provide bidirectional RS-232 communication with periphery devices at remote endpoints through optical extenders. This communication is transmitted over the same fiber cable as the video signal and the settings are available on the panel.

### 6.5.3.2. DVI-OPT Type Input Ports

Supported Boards:

- MX-DVI-OPT-IB-LC, -SC, -ST, -NT
- MX-DVIDL-OPT-IB-LC, -NT

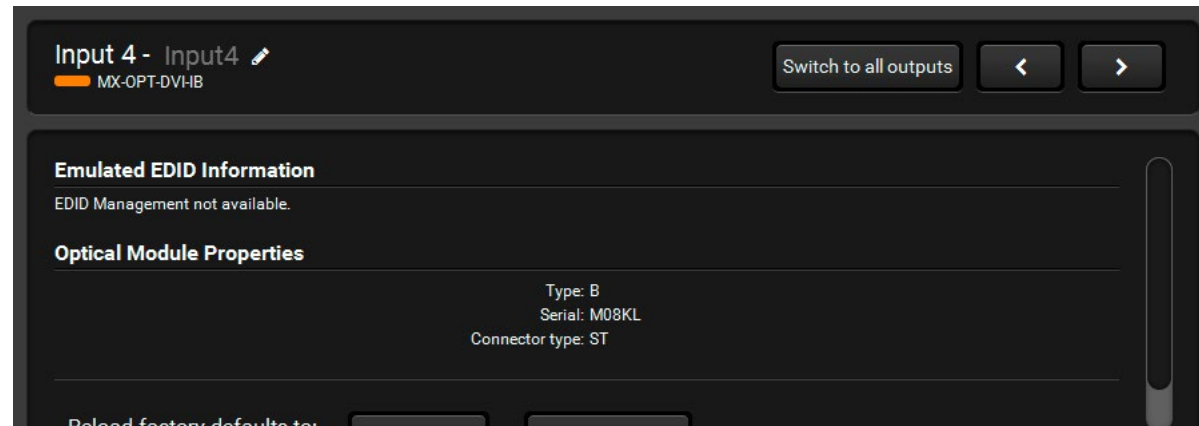

**Input Parameters of DVI-OPT Type Input Port**

### 6.5.3.3. DVIDL Type Input Ports

Supported Boards:

- MX-DVIDL-IB

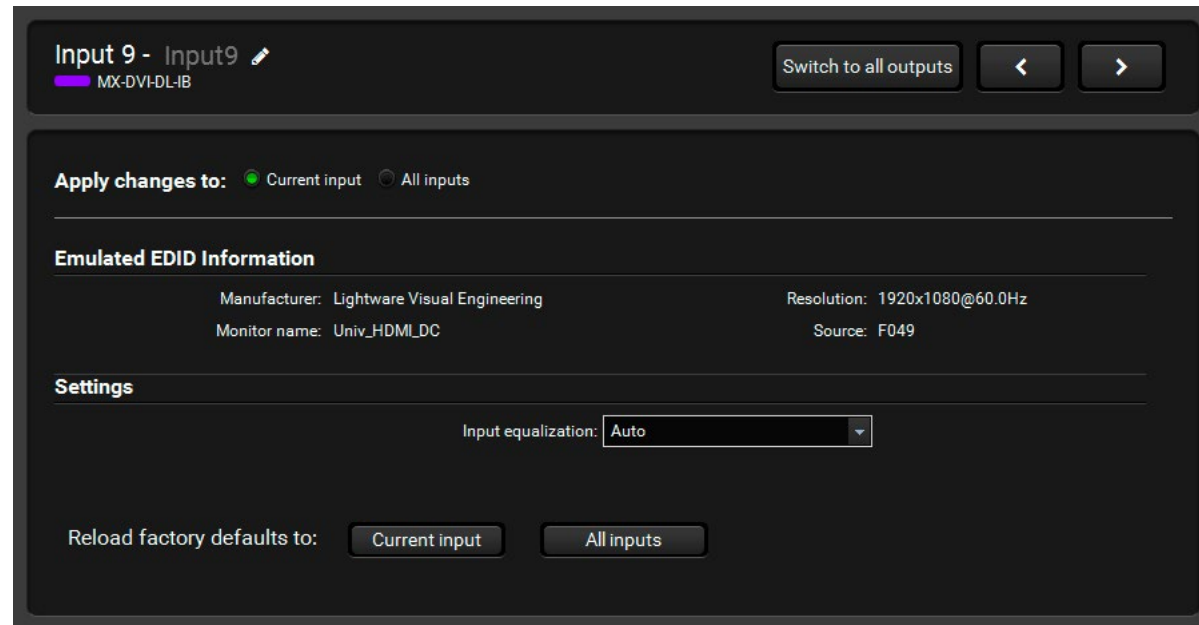

**Input Parameters of DVI-DL-IB Type Input Port**

### Cable Equalization

**Automatic** mode usually provides perfect transmission but at longer distances and higher resolutions, manual equalization may be necessary. Manual equalization can be set to fix **3, 9, 25, 35** or **40dB**. Longer cables need higher equalization.

### 6.5.3.4. DVI-D Type Input Ports

Supported Boards:

- MX-DVID-IB
- MX-DVI-TP-IB
- MX-DVI-TP-IB+

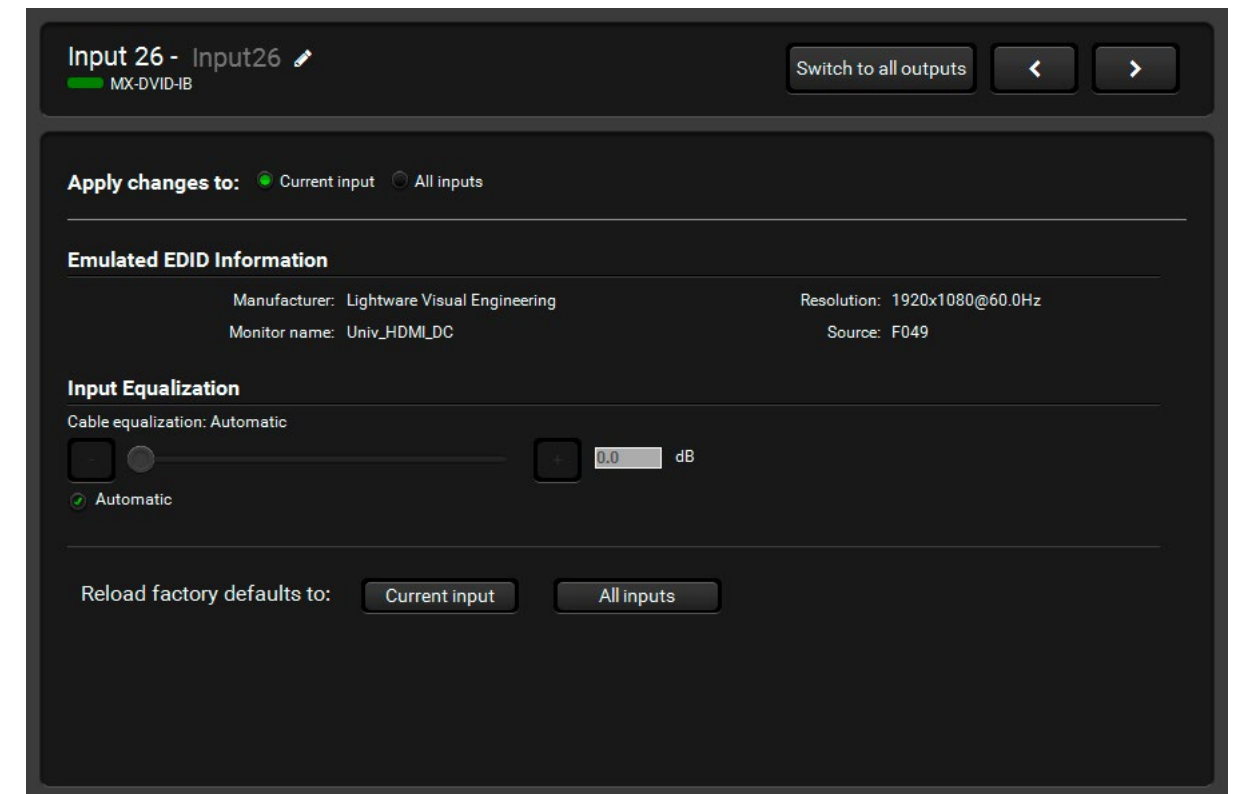

**Input Parameters of DVI-D Type Input Port**

### Cable Equalization

To disable automatic equalization turn the checkbox off. This enables the slider to set the equalization level manually. Keep in mind that a previously set manual equalization level may not be suitable for a different system. It is always advised to use the automatic mode and adjust the equalization manually if the auto mode does not give a good result.



### 6.5.3.5. HDMI Type Input Ports

Supported Boards:

- MX-HDMI-IB, MX-DVI-HDCP-IB, MX-HDMI-TP-IB
- MXD-HDMI-TP-IB, MX-CPU2 Test input

The screenshot displays the configuration page for 'Input 2 - Input2' (MX-HDMHB). At the top, there are navigation buttons: 'Switch to all outputs', a left arrow, and a right arrow. Below this, the 'Apply changes to:' section has radio buttons for 'Current input' (selected) and 'All inputs'. The main content is divided into several sections:

- Emulated EDID Information:** Shows Manufacturer: Lightware Visual Engineering, Resolution: 1920x1080@60.0Hz, Monitor name: Univ\_HDMI\_DC, and Source: F049.
- Settings:** Includes 'Input equalization' set to 'Auto', 'Color range' set to 'No change', and 'HDCP enable' checked.
- Incoming Audio Signal Info:** Shows Format: PCM, Sampling frequency: 48 kHz, and Channels: 2 ch.
- Frame Detector:** Contains a 'Frame detector' button.
- Status:** Displays '+5V present: Present', 'Signal present: Present', 'HDMI/DVI: HDMI 24 bit', and 'HDCP: None'.
- Incoming Video Signal Info:** Lists Resolution: 1280x720p60, Scan: Progressive, Colorspace: RGB, Vsync: 60 Hz, Hsync: 45.0 kHz, Vertical sync polarity: Positive, Horizontal sync polarity: Positive, Pixel clock stable: PLL locked, Pixel repetitions: No repetition, Aspect ratio: 16:9, and Dimension: 2D video.

At the bottom, there are buttons for 'Reload factory defaults to:' with options for 'Current input' and 'All inputs'.

**Input Parameters of HDMI Type Input Port**

### Cable Equalization

The Auto setting means that equalization will be adaptive (depending on the cable length). By default, automatic equalization is enabled. Automatic mode usually provides perfect transmission but at longer distances and higher resolutions, manual equalization may be necessary. Manual equalization can be set to fix 3, 9, 25, 35 or 40dB. Longer cables need higher equalization.

Keep in mind that a previously set manual equalization level may not be suitable for a different system. It is always advised to use the automatic mode and only adjust the equalization manually if the auto mode does not give a good result.

**INFO:** The MX-CPU2 Test input port does not have cable equalization!

### Color Range Setting

Some sources may send the video signal with different color range. If the black or white level seems to be incorrect in the picture try to set this parameter to compress or expand the color range. The default setting is no change which gives good result in most cases.

### Input Status

Basic signal status is displayed:

- **+5V present:** Shows if there is a source device connected to the input port.
- **Signal present:** Shows if there is a valid video signal present on the input port.
- **DVI/HDMI:** The signal mode is detected and shown including DVI or HDMI mode and color depth.
- **HDCP:** Shows if the incoming signal is encrypted or not.

### 6.5.3.6. HDMI-3D Type Input Port

Supported Boards:

- MX-4TPS2-4HDMI-IB, -A, -S, -P, -AP, -SP (only the four HDMI ports of the boards)
- MX-HDMI-3D-IB, -A, -S
- MX-DVI-4K-IB

Input board with HDMI or DVI-I ports and 3D signal support. Boards with additional audio features contain more options as shown in the screenshot, see the **Settings** section. For the better understanding of these audio modes please see the port diagrams in the following section.

#### Port Diagrams

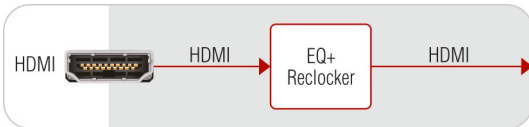
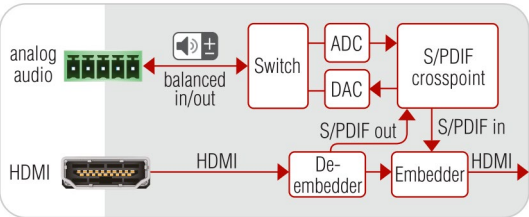
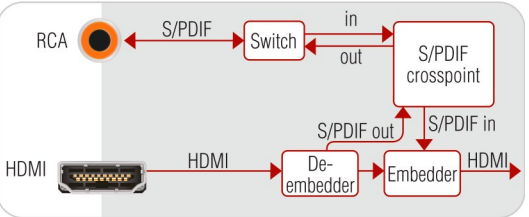
<p><b>MX-HDMI-3D-IB</b>  <b>MX-4TPS2-4HDMI-IB*</b>  <b>MX-4TPS2-4HDMI-IB-P*</b></p> <p>Plain HDMI input board with 3D support without additional audio ports.</p>	
<p><b>MX-HDMI-3D-IB-A</b>  <b>MX-4TPS2-4HDMI-IB-A*</b>  <b>MX-4TPS2-4HDMI-IB-AP*</b></p> <p>HDMI input board with 3D support and additional analog audio port. The additional audio port can be used as an input (embedding the analog audio signal in the HDMI stream), or it can be used as an output (de-embedding the audio content of the HDMI stream).</p>	
<p><b>MX-HDMI-3D-IB-S</b>  <b>MX-4TPS2-4HDMI-IB-S*</b>  <b>MX-4TPS2-4HDMI-IB-SP*</b></p> <p>HDMI input board with 3D support and additional S/PDIF audio port. The additional audio port can be used as an input (embedding the digital audio signal in the HDMI stream), or it can be used as an output (de-embedding the audio content of the HDMI stream).</p>	

\* Refers only to the four HDMI ports of the board.

#audio #analogaudio

For detailed information about the audio settings see the [Audio Options](#) section.

**Input 19 - Input19** ✎

MX-HDMI-3D-IB-S

Switch to all outputs

⏪ ⏩

---

Apply changes to:  Current input  All inputs

---

**Emulated EDID Information**

Manufacturer: Lightware Visual Engineering      Resolution: 1920x1080@60.0Hz

Monitor name: Univ\_HDMI\_DC      Source: F049

**Settings**

Audio mode: HDMI audio passthrough

HDCP enable: ✔

**Incoming Audio Signal Info**

Format: PCM

Sampling frequency: 44.1 kHz

Channels: 2 ch

---

**Test Pattern Settings**

Test pattern mode: Off

Test pattern clock: 480p 60Hz

Test pattern: Color bar

Test pattern generator inactive.

**Frame Detector**

Frame detector

---

**Status**

+5V present: Present

Signal present: Present

HDMI/DVI: HDMI 24 bit

HDCP: None

**Forwarded Signal**

Resolution: 1280x720p60

Signal mode: HDMI 24 bit

Embedded audio: HDMI passthrough

---

**Incoming Video Signal Info**

Resolution: 1280x720p60

Scan: Progressive

Colorspace: RGB

Vsync: 60 Hz

Hsync: 45.0 kHz

Vertical sync polarity: Positive

Horizontal sync polarity: Positive

Pixel clock stable: PLL locked

Pixel repetitions: No repetition

Aspect ratio: 16:9

Dimension: 2D video

**AUX Audio**

Addon type: No addon

Status: Not used

---

Reload factory defaults to:

Current input
All inputs

Input Parameters of HDMI-3D Type Input Port (MX-HDMI-3D-IB-S)

### 6.5.3.7. DVI-I Type Input Port

Supported Boards:

- MX-DVII-HDCP-IB
- MXD-UMX-IB

#### Video Source

The signal type of the connected source can be selected in the drop down list: Analog RGB, Analog YUV, Analog Auto, Digital, or Auto source. The Auto source setting accepts both digital and analog signals on the input and selects the one which is firstly detected.

#### Audio Source (refers to the MXD-UMX-IB board only)

The signal which is sent to the matrix crosspoint can have embedded audio.

- **No Audio:** Disable the audio of the signal.
- **HDMI Audio:** Leave the incoming signal as it is.
- **Audio Addon:** Use the analog stereo or S/PDIF audio input and embed it to the HDMI signal.

#### Output Format

The output signal type can be selected (DVI or HDMI mode) which is sent towards the matrix crosspoint.

- **Pass HDMI:** Sending HDMI signal to the crosspoint only if the incoming signal is HDMI or the audio settings are set to embed audio.
- **Force DVI:** Sending only DVI signal to the crosspoint without embedded audio.
- **Automatic:** Detecting the output board types in the matrix frame and setting the signal type accordingly. If there are only HDMI compatible output boards then the signal type will be HDMI. If there is one or more DVI output boards in the matrix frame then the signal type will be DVI. (Note that DVI-HDCP boards are HDMI compliant.)

#### Analog Video Options

Analog video signals are digitized on the input. The input port measures the incoming analog signal and determines timings. If the parameters need adjustment, it can be done on the right side at Analog options. In this case, the Timing ID field changes to User modified until the parameters are saved.

The timing parameters can be adjusted if needed and the timing presets can be saved for each resolution separately.

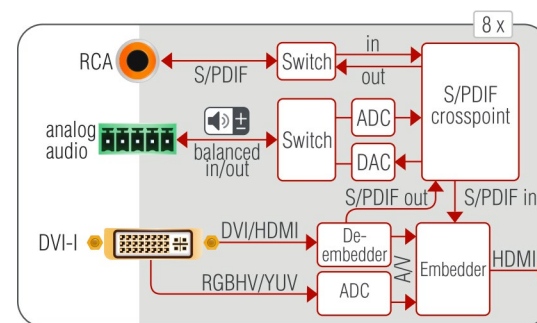

**ATTENTION!** The automatic signal format detection requires the incoming signal be in line with the EDID set on the input which requires proper cabling. Always use high-quality cable for connecting sources: a VGA cable where all the pins are wired (DDC channel) with the supplied VGA-DVI-A converter or a direct VGA-DVI cable is highly recommended. #audio #analogaudio

DVI-I Type Input Port Properties (MXD-UMX-IB)



**Audio Conversion Mode**

The analog stereo and S/PDIF audio ports can be configured as inputs and outputs as well. (The LEDs next to the connectors indicate if the port works as an input or an output to prevent wrong connections.) If they are configured as input, the signal can be used to embed in the HDMI stream and/or output on the other audio connector. The available modes:

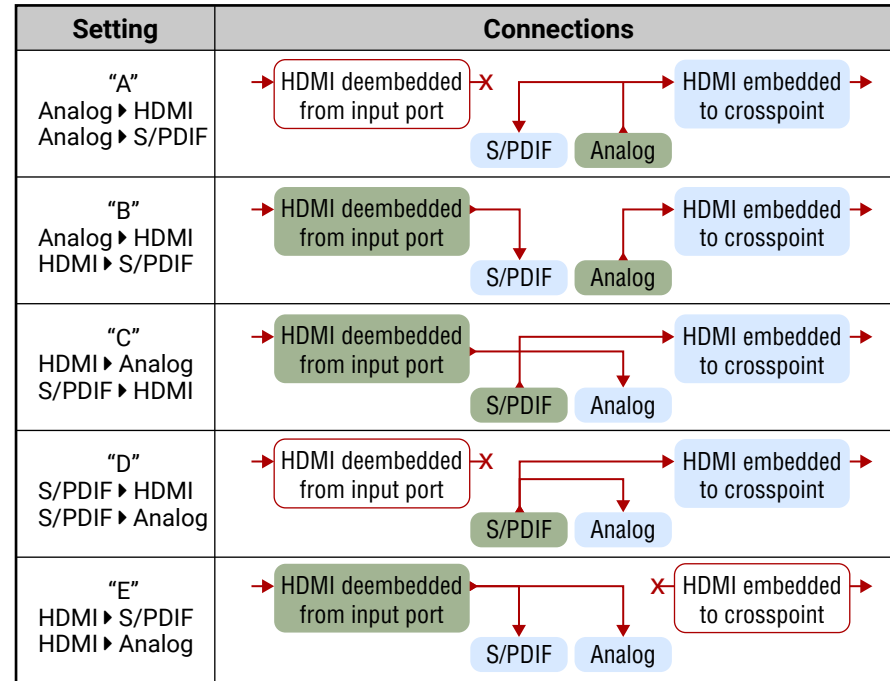

**Audio Conversion Modes**

**Analog Audio Settings**

Analog audio input settings: These settings appear only if the analog audio port is configured as an input. Volume, balance, gain, phase invert and DC filter can be adjusted.

Analog audio output settings: These settings appear only if the analog audio port is configured as an output. Volume, balance, bass, treble, deemphasis, and phase invert can be adjusted.

**ATTENTION!** The conversion between S/PDIF or HDMI and analog audio is available only with PCM stereo audio signals.

#audio #analogaudio

**6.5.3.8. TPS Type Input Port**

Supported Boards:

- MX-TPS-IB, -S, -A, -P, -SP, -AP
- MX-4TPS2-4HDMI-IB, -A, -S, -P, -AP, SP (only the four TPS ports of the board)

**Audio Mode**

Here can be selected which audio signal will be embedded in the forwarded HDMI signal. It can be set to '(A) No audio', '(B) HDMI audio passthrough', '(C) Embed from aux audio', '(D) Deembed to aux audio' or '(E) HDMI passthrough and deemb to aux audio'. See also the [Audio Options](#) section.

**TPS Mode Setting**

The required mode can be HDBaseT, Longreach, Automatic, RS232 only and RS232+ETH only. For detailed information about the TPS modes see the [TPS Link Modes](#) section. If the PoE is supported by the board, the feature can be enabled/disabled in this section.

**Remote Device (valid only for certain extenders)**

TPS boards can display the name of the remote Lightware device; it is displayed in the TPS Link section. Click on the Open remote device settings button to open a new window:

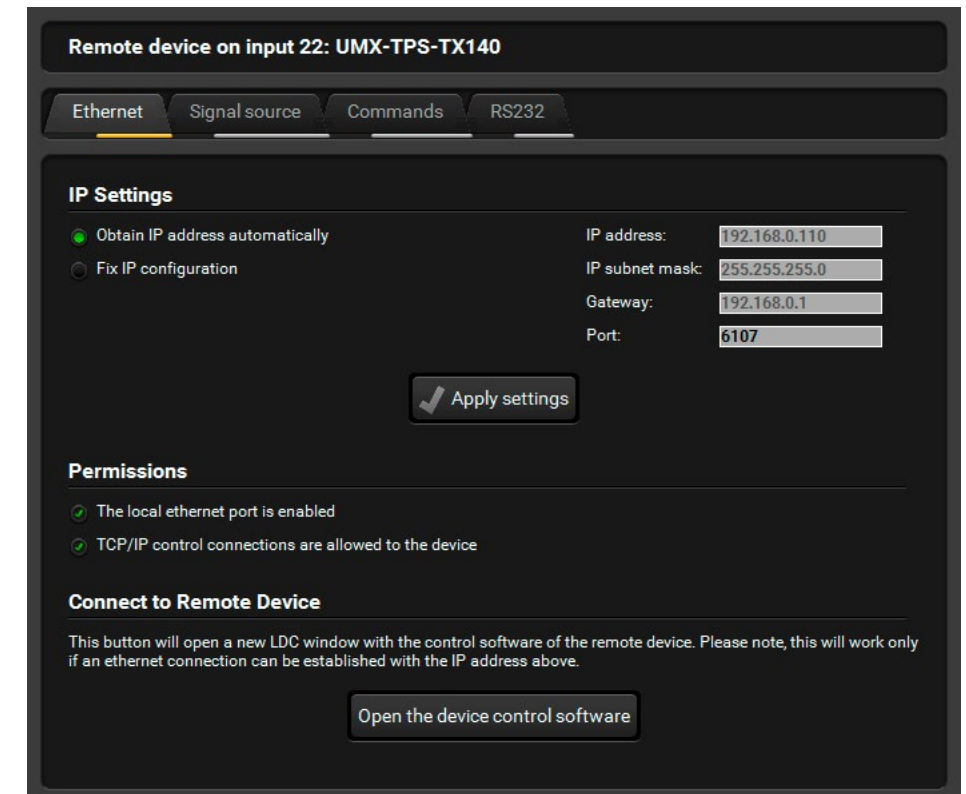

**Remote Device Properties**

Numerous settings and parameters are available on the tabs, like:

- Changing TCP/IP settings, opening a new LDC window showing the remote device.
- Changing the crosspoint, Autoselect on/off, showing mute and lock states of the outputs.
- Terminal window to send LW2 commands.
- RS-232 port settings of the device's local port.

**Firmware Settings**

The settings and the upgrade process is described in the [Firmware Upgrade of TPS\(2\) Ports](#) section.

**Power over Ethernet (refers only to TPS2 boards)**

The PoE-compatible Remote power feature can be enabled port by port under TPS link section and the current state is shown in the following line

**Port Diagrams**

**ATTENTION!** The diagrams of TPS2 ports can be seen on the figures which are almost the same as of TPS ports. The only difference is the remote power feature (12V / 48V).

<p><b>MX-TPS-IB</b>  <b>MX-TPS2-IB-P</b>  <b>MX-4TPS2-4HDMI-IB*</b>  <b>MX-4TPS2-4HDMI-IB-P*</b></p> <p>Plain TPS input board with remote power support without additional audio ports.</p>	
<p><b>MX-TPS-IB-A</b>  <b>MX-TPS2-IB-AP</b>  <b>MX-4TPS2-4HDMI-IB-A*</b>  <b>MX-4TPS2-4HDMI-IB-AP*</b></p> <p>TPS input board with remote power support and additional analog audio port. The additional audio port can be used as an input (embedding the analog audio in the video of the TPS signal) or it can be used as an output (de-embedding the audio of the HDMI stream).</p>	
<p><b>MX-TPS-IB-S</b>  <b>MX-TPS2-IB-SP</b>  <b>MX-4TPS2-4HDMI-IB-S*</b>  <b>MX-4TPS2-4HDMI-IB-SP*</b></p> <p>TPS input board with remote power support and additional S/PDIF audio port. The additional audio port can be used as an input (embedding the digital audio in the video of the TPS signal), or it can be used as an output (de-embedding the audio of the HDMI stream).</p>	

\* Refers only to the four TPS ports of the board. #audio #analogaudio

For detailed information about the audio settings see the [Audio Options](#) section.

The screenshot displays the control interface for 'Input 22 - Input22' (MX-TPS2-IB). It includes several sections:

- Apply changes to:** Radio buttons for 'Current input' (selected) and 'All inputs'.
- Emulated EDID Information:** Manufacturer: Lightware Visual Engineering, Monitor name: Univ\_HDMI\_DC, Resolution: 1920x1080@60.0Hz, Source: F049.
- Settings:** Audio mode: HDMI audio passthrough, HDCP enable: checked.
- TPS Link:** Required mode: Automatic mode, Actual state: HDBaseT mode, Remote device: UMX-TPS-TX140.
- Test Pattern Settings:** Test pattern mode: Off, Test pattern clock: 480p 60Hz, Test pattern: Color bar. Status: Test pattern generator inactive.
- Status:** +5V present: Present, Signal present: Present, HDMI/DVI: HDMI 24 bit, HDCP: None.
- Incoming Video Signal Info:** Resolution: 1280x720p60, Scan: Progressive, Colorspace: RGB, Vsync: 60 Hz, Hsync: 45.0 kHz, Vertical sync polarity: Positive, Horizontal sync polarity: Positive, Pixel clock stable: PLL locked, Pixel repetitions: No repetition, Aspect ratio: 16:9, Dimension: 2D video.
- Incoming Audio Signal Info:** Format: PCM, Sampling frequency: 48 kHz, Channels: No info.
- TPS Card Status:** Ethernet uplink connection: Inactive, Average board temperature: 34 °C / 93 °F.
- TPS Cable Diagnostics:** Shows a T568B cable with error rates for pins 18, 19, 19, and 17, all at -21 dB MSE. Estimated cable length: <20 m (Cat5) / <30 m (Cat7). Includes a button for 'Open TPS cable diagnostics'.
- Frame Detector:** Includes a 'Frame detector' button.
- Forwarded Signal:** Resolution: 1280x720p60, Signal mode: HDMI 24 bit, Embedded audio: HDMI passthrough.
- AUX Audio:** Addon type: No addon.

**TPS Input Port Properties (MX-TPS2-IB)**

### 6.5.3.9. 3G-SDI Type Input Port

Supported Board:

- MX-3GSDI-IB

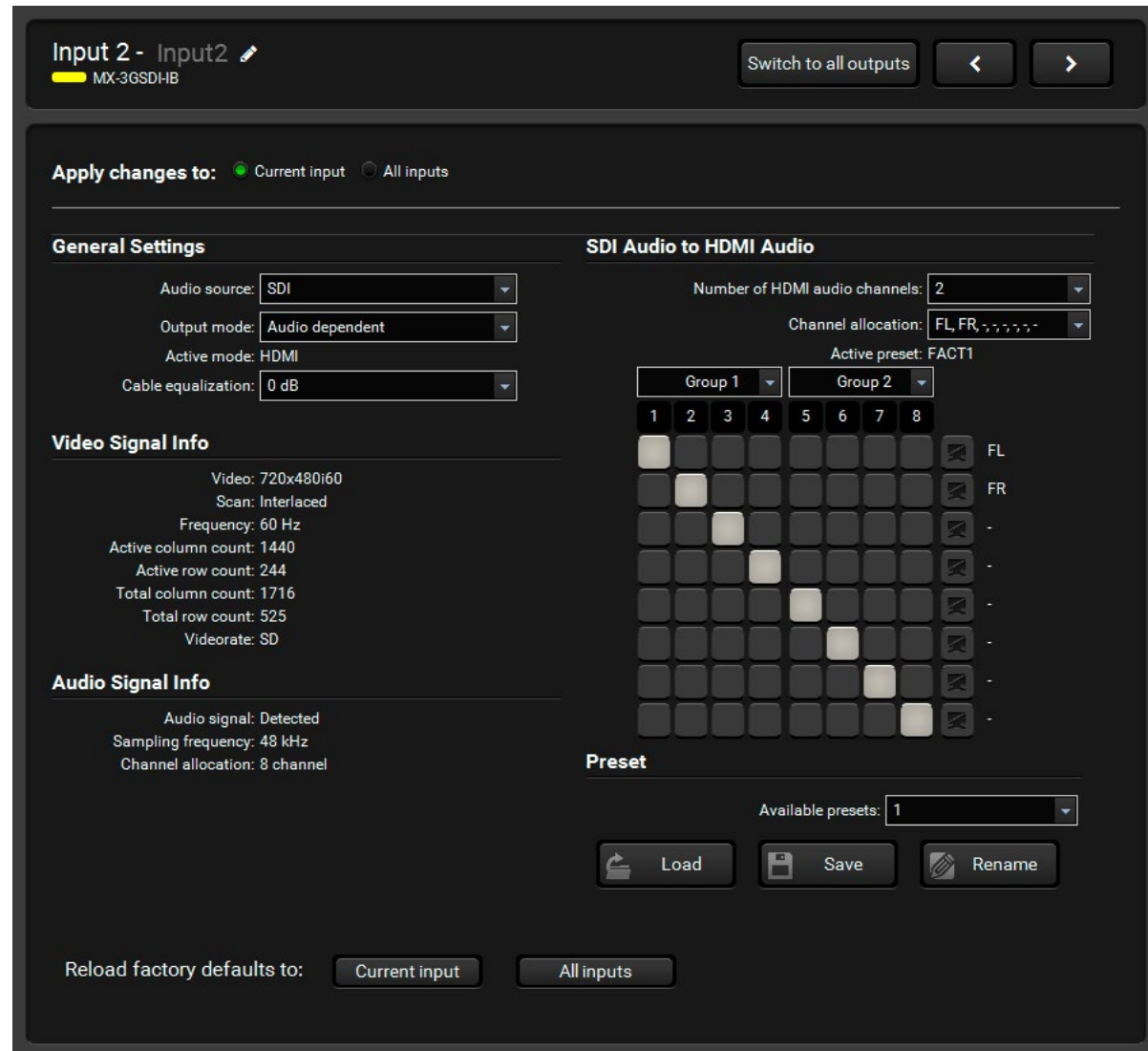

3G-SDI Type Input Port Properties (MX-3GSDI-IB)

#### Audio Source

The audio source which is embedded in the forwarded HDMI signal can be set.

- SDI:** The audio from the SDI input will be embedded in the forwarded signal.
- S/PDIF:** The audio from the S/PDIF input will be embedded in the forwarded signal.
- No audio:** No audio is embedded in the forwarded signal.

#### Output Mode

The output signal type can be selected (DVI or HDMI mode) which is sent towards the matrix crosspoint.

- Audio dependent:** Sending HDMI signal to the crosspoint if the audio source is set to embed audio from SDI or S/PDIF.
- Force HDMI:** Sending HDMI signal to the crosspoint always. If there is no incoming audio on the selected audio source then silence is embedded in the forwarded signal.
- Force DVI:** Sending only DVI signal to the crosspoint without embedded audio.
- Frame compatible:** Detecting the output board types in the matrix frame and setting the signal type accordingly. If there are only HDMI compatible output boards then the signal type will be HDMI. If there are one or more DVI output boards in the matrix frame then the signal type will be DVI. (Note that DVI-HDCP boards are HDMI compliant.)

#### Input EQ

Long cables have to be equalized on the input port. The Auto setting gives good result in most cases. The 0 dB (disabled) setting switches off equalization.

#### Video Signal Info

The detected incoming signal resolution and signal type (SD, HD or 3G) is shown. The active mode indicates the signal type which is currently forwarded to the crosspoint (DVI or HDMI).

#### SDI Audio Channel Allocation

The incoming SDI embedded audio channels can be rearranged and allocated to HDMI audio channels. The channel allocation setups can be saved as presets. SDI audio allocation presets are common for all SDI input ports in the matrix. 3G-SDI signals can have up to 16 audio channels in 4 groups. The input port can work with any 2 groups of the 4.

#### Presets

There are 4 factory presets for the most common audio channel allocations. Moreover, there are 5 user-configurable presets which can be renamed as well. To load an audio allocation preset, select the desired preset from the drop-down list and then press Load. The audio channel crosspoint shows the current allocation. To rename a user audio allocation preset, select the desired preset from the drop-down list and then press Rename. Type the new name in the pop-up window and click OK. Preset names can be up to 5 characters long.

#### HDMI Audio Channel Allocation

The forwarded HDMI signal has to be set up correctly to indicate the channel allocation. This helps the connected display device or AV receiver to know which audio channels have to be used for which speakers. Select how many audio channels (speakers) have to be used. Then select the desired speaker assignment. These settings define the "outputs" of the below audio channel crosspoint.

#### Audio Channel Crosspoint

This crosspoint view can be used to set up the channel allocation between the incoming SDI embedded audio and the forwarded HDMI embedded audio. The columns represent the channels of the incoming SDI audio channels. The rows represent the channels of the forwarded HDMI embedded audio. SDI audio channels are highlighted with a yellow background if there is a signal detected.



## 6.5.4. Output Port Properties

### 6.5.4.1. DVI-D Type Output Port

Supported Boards:

- MX-DVID-OB
- MX-DVI-TP-OB, -OB+

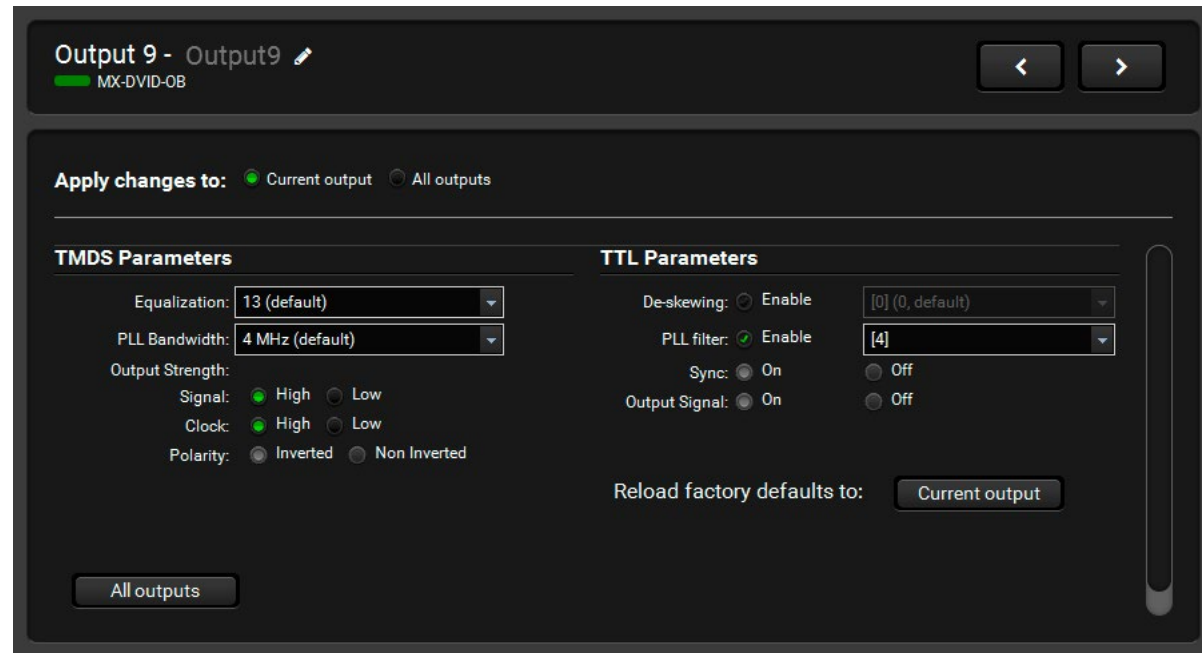

**DVI-D Output Port Properties (MX-DVID-OB)**

#### Parameters

The factory default settings give good result in most cases. Please contact Lightware Support ([support@lightware.com](mailto:support@lightware.com)) for further information if encountering problems with output signals.

### 6.5.4.2. DVI-DL Type Output Port

Covered board:

- MX-DVIDL-OB

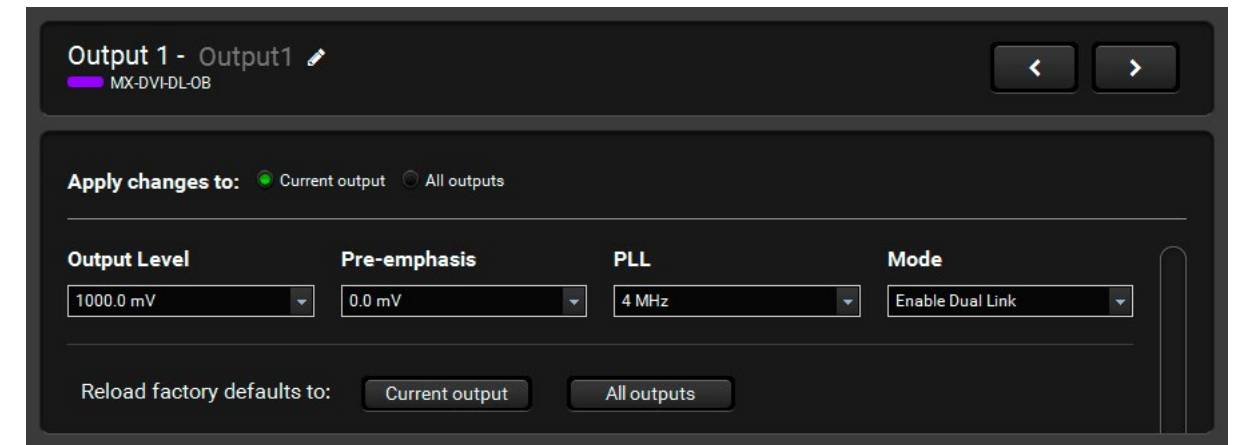

**DVI-DL Type Output Port Properties (MX-DVI-DL-OB)**

#### Output Level

The output signal strength (voltage swing) can be set. The default setting gives good result in most cases.

#### Pre-emphasis Level

The output signal can be boosted so it may pass-through a longer cable to the display device. The default setting gives good result in most cases.

#### PLL Bandwidth

The signal is reclocked on the output. The reclocking performance can be adjusted if the signal drops on the display device. The default setting gives good result in most cases.

#### Dual-Link Mode

The Dual-Link output port can be configured to disable the TMDS wires needed for Dual-Link signals. This can solve problems with Dual-Link monitors when a Single-Link signal is routed to them.

- **Enable Dual-Link:** The dual-link channel is enabled disregarding the input port type. Some Dual-Link monitors may display distorted, squeezed picture when the signal comes from a Single-Link input port.
- **Disable Dual-Link:** The Dual-Link channel is disabled. In this case, Dual-Link signal is not received. Use this setting if a Single-Link signal has to be routed to the output and the Auto mode does not work.
- **Auto Mode:** Enables or disables the Dual-Link channel depending on the input port type. If the input port is Single-Link then the Dual-Link channel is disabled. If the input port is Dual-Link then the Dual-Link channel is enabled. Note that only the port type matters, not the signal type on the port.

### 6.5.4.3. HDMI Type Output Port

Supported Boards:

- MX-HDMI-OB, MX-DVI-HDCP-OB
- MX-HDMI-TP-OB, MXD-HDMI-TP-OB
- MX-CPU2 Preview Output

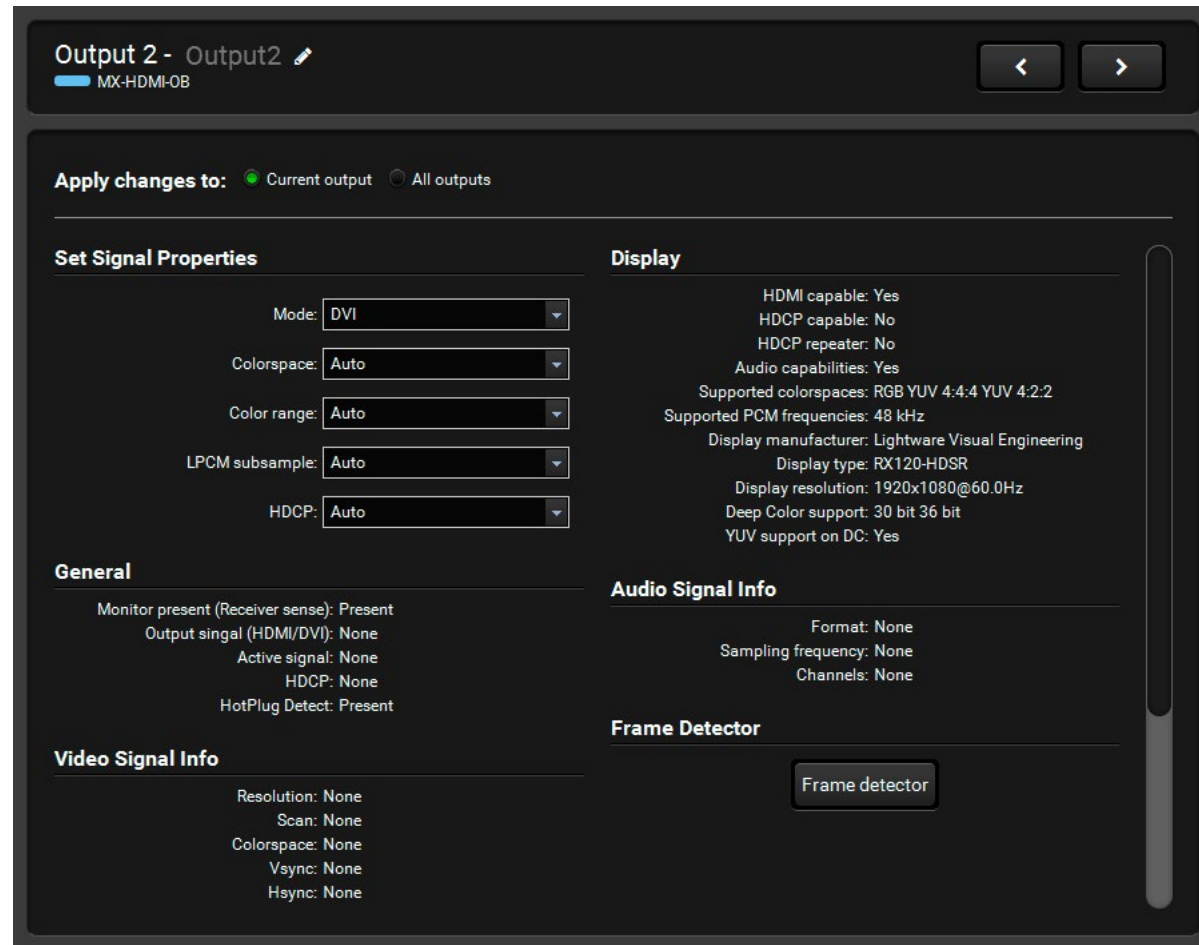

**HDMI Type Output Port Properties (MX-HDMI-OB)**

#### Output Mode

The signal mode can be set to DVI, HDMI 24bit, HDMI 30bit, HDMI 36bit or Auto mode. The Auto option sets the signal mode regarding the attached display device's EDID and the incoming signal.

#### Color Range

Some sources may send the video signal with different color range. If the black or white level seems to be incorrect in the picture try to set this parameter to compress or expand the color range. The default setting is no change which gives good result in most cases.

### 6.5.4.4. HDMI-3D Type Output Port

Supported Boards:

- MX-HDMI-3D-OB, -A, -S; MX-4TPS2-4HDMI-OB, -A, -S, -P, -AP, -SP (only the four HDMI ports of the board)
- MX-DVI-4K-OB

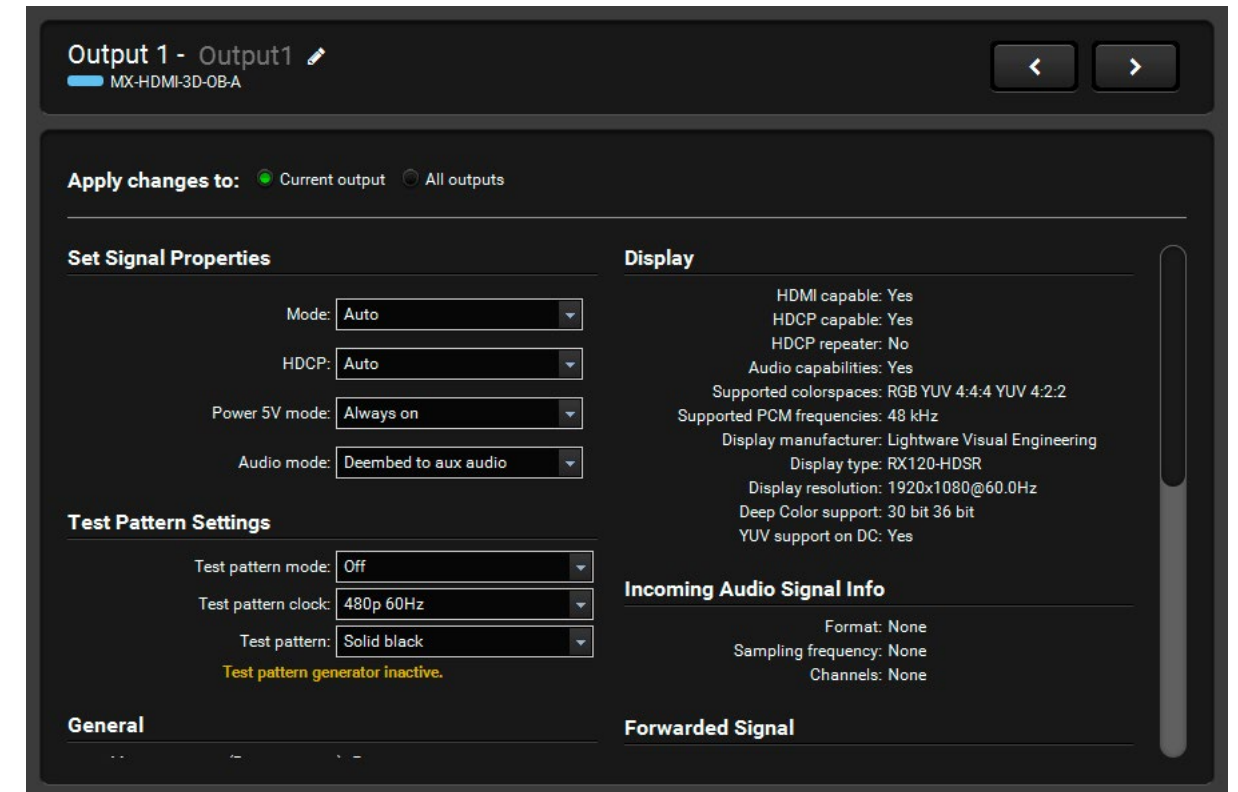

**HDMI-3D Type Output Port Properties (MX-HDMI-3D-OB-A)**

#### Power 5V Mode `#power5v`

The DVI or HDMI 5V line can be controlled on an output port with the 'PWR5V mode'. If it is 'On' the 5V DC is always active. If it is 'Off' the port never sends the 5V DC.

**INFO:** If the 5V line is off sink devices do not send HotPlug signal and their EDIDs will not be read.

The Auto mode means the port gives the 5V but if the video signal changes (e.g. resolution) it turns off the 5V for 1 sec and turns it on again. This mode is useful for sink devices which are not able to handle properly the changing of the video signal.

#### Audio Mode

Here can be selected which audio signal will be embedded in the forwarded HDMI signal. It can be set to '(A) No audio', '(B) HDMI audio passthrough', '(C) Embed from aux audio', '(D) Deembded to aux audio' or '(E) HDMI passthrough and deemb to aux audio'. For detailed information about the audio settings see the [Audio Options](#) section. `#audio`

#### 6.5.4.5. DVI-OPT Type Output Port

Supported Boards:

- MX-DVI-OPT-OB-LC, -SC, -ST
- MX-DVIDL-OPT-OB-LC, -NT
- MX-DVI-OPT-OB-R-LC, -NT, -SC, -ST

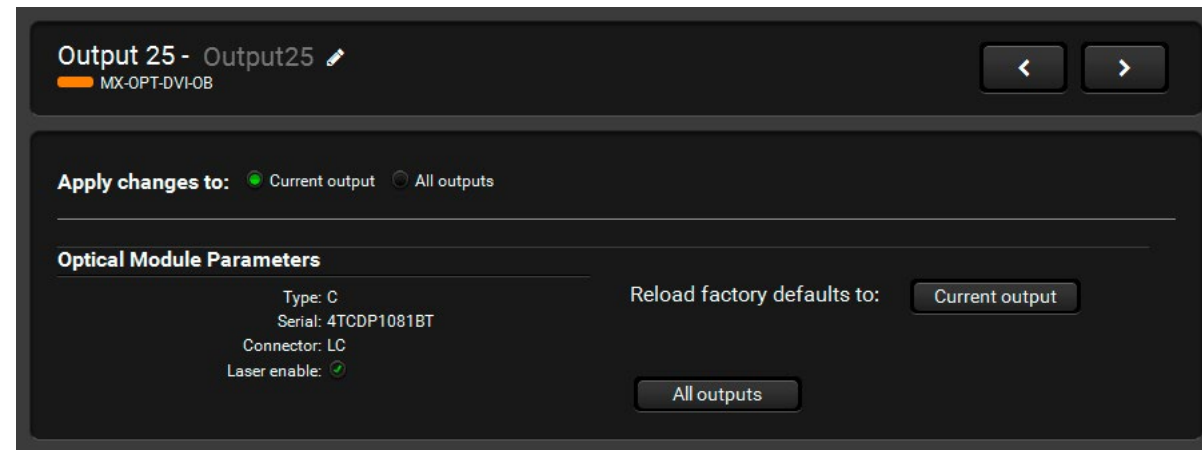

**DVI-OPT Output Port Properties (MX-DVI-OPT-OB-LC)**

#### Laser Enable

The optical module can be powered down with this setting. This can help to prevent aging of the laser transmitter. If the laser is disabled then no signal transmission is available

INFO: The port properties window of MX-DVIDL-OPT-OB boards look the same as above.

#### 6.5.4.6. HDMI-OPT Type Output Port

Supported board:

- MX-HDMI-OPT-OB-LC, -NT, -SC

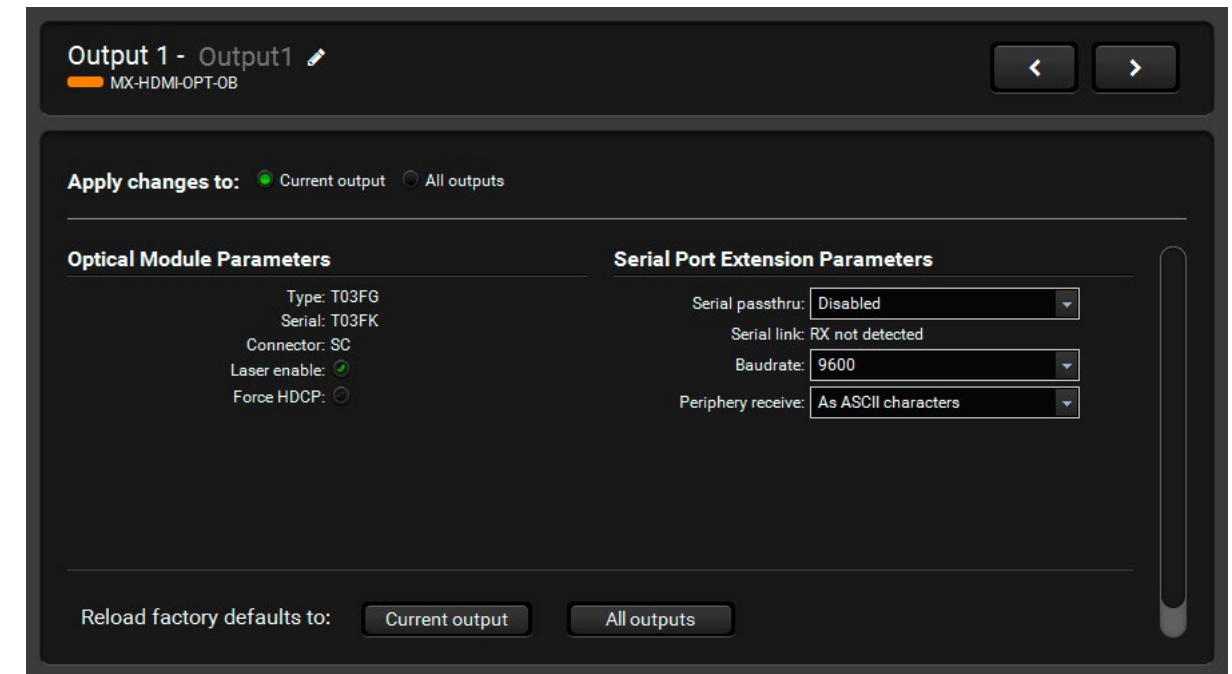

**HDMI-OPT Type Output Port Properties (MX-HDMI-OPT-OB-SC)**

#### Optical Module Parameters

The connector type is the standard name of the fiber connector which is mounted on the back plate of the board. The connector type can be: LC, SC, ST, and NT (Neutrik OpticalCON).

#### Laser Enable

The optical module can be powered down with this setting. This can help to prevent aging of the laser transmitter. If the laser is disabled then no signal transmission is available.



### 6.5.4.7. HDMI-OPT-R Type Output Port

Supported Boards:

- *MX-HDMI-OPT-OB-R-LC, -NT, -SC*

#### Optical Module Parameters

The connector type is the standard name of the fiber connector which is mounted on the back plate of the board. The connector type can be: LC, SC, and NT.

#### Laser Enable

The optical module can be powered down with this setting. This can help to prevent aging of the laser transmitter and save lifetime. If the laser is disabled then signal is not transmitted.

**Output 19 - Output19**  
MX-HDMI-OPT-OB-R

Apply changes to:  Current output  All outputs

#### Set Signal Properties

Mode:

HDCP:

Audio mode:

#### Test Pattern Settings

Test pattern mode:

Test pattern clock:

Test pattern:

*Test pattern generator inactive.*

#### General

Monitor present (Receiver sense): Present  
Output signal (HDMI/DVI): HDMI  
Active signal: Present  
HDCP: None

#### Video Signal Info

Resolution: 1280x720p60  
Scan: Progressive  
Colorspace: RGB  
Vsync: 60 Hz

#### Display

HDMI capable: Yes  
HDCP capable: No  
HDCP repeater: No  
Audio capabilities: Yes  
Supported colorspace: RGB YUV 4:4:4 YUV 4:2:2  
Supported PCM frequencies: 32 44 48 kHz  
Display manufacturer: Samsung Electric Company  
Display type: T24B301  
Display resolution: 1920x1080@60.0Hz  
Deep Color support: 30 bit 36 bit  
YUV support on DC: Yes

#### Audio Signal Info

Format: No audio  
Sampling frequency: -  
Channels: -

#### Forwarded Signal

Resolution: 1280x720p60  
Signal mode: HDMI 24 bit  
Embedded audio: HDMI passthrough

#### Frame Detector

**HDMI-OPT-R Type Output Port Properties (MX-HDMI-OPT-OB-R-SC)**

### Signal Properties

- The signal **mode** can be set to DVI, HDMI or No change mode.
- The **HDCP** encryption can be set to Auto or Always.
- The **Audio mode** can be set to HDMI audio passthrough or No audio.

### 6.5.4.8. Audio Type Output Port

Covered board:

- *MX-AUDIO-OB-A*    *#audio*    *#analogaudio*    *#volume*

**Output 17 - Output17**  
MX-AUDIO-OB-A

Apply changes to:  Current output  All outputs

#### Incoming Video Signal Info

Resolution: None  
Scan: None  
Colorspace: None  
Vsync: None  
Hsync: None  
Vertical sync polarity: None  
Horizontal sync polarity: None  
Pixel clock stable: None  
Pixel repetitions: None  
Aspect ratio: None  
Dimension: None

#### Incoming Audio Signal Info

Format: None  
Sampling frequency: None  
Channels: None

#### AUX Audio

Addon type: Analog stereo  
Status: Output

#### Audio Output Settings

Volume:  dB

Balance:

Bass:  dB

Treble:  dB

Pre-emphasis  
 Phase invert

Reload factory defaults to:

**Audio Type Output Port (MX-AUDIO-OB-A)**

Plain audio output board forwarding audio signals only. The sliders allow to adjust the desired output levels

### 6.5.4.9. TPS Type Output Port

Supported Boards:

- MX-TPS-OB, -S, -A
- MX-TPS2-OB-P, -AP, -SP
- MX-4TPS2-4HDMI-OB, -A, -S, -P, -AP, SP (only the four TPS ports of the board)

Port Diagrams #power5v

**ATTENTION!** The diagrams of TPS2 ports can be seen on the figures which are almost the same as of TPS ports. The only difference is the remote power feature (12V / 48V).

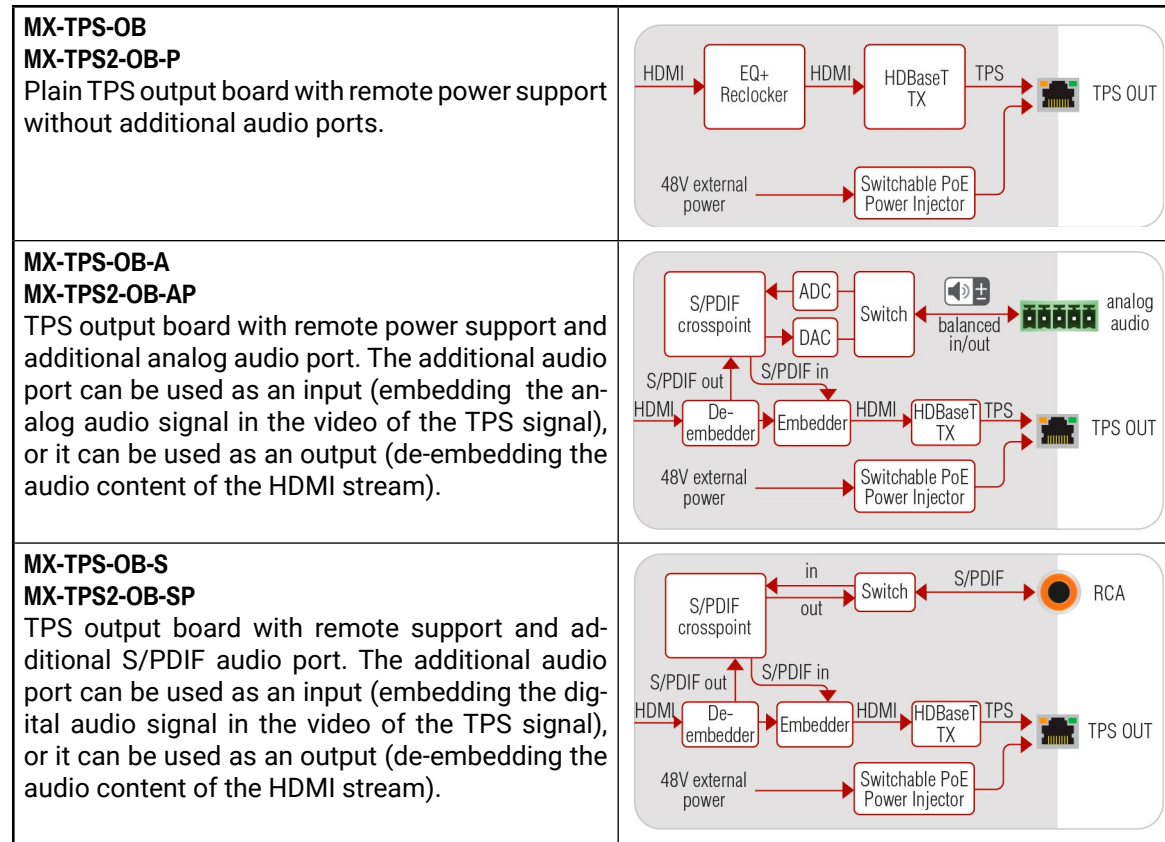

#### TPS Mode Setting

The required mode can be HDBaseT, Longreach, Automatic, RS232 only and RS232+ETH only. For detailed information about the TPS modes see the [TPS Link Modes](#) section.

**Audio Mode** #audio #analogaudio

Here can be selected which audio signal will be embedded in the forwarded HDMI signal. It can be set to '(A) No audio', '(B) HDMI audio passthrough', '(C) Embed from aux audio', '(D) Deembded to aux audio' or '(E) HDMI passthrough and deemb to aux audio'; see also the [Audio Options](#) section.

#### Power over Ethernet (refers only to TPS2 boards)

The PoE-compatible remote power feature can be enabled on each port individually under TPS link section and the current state is shown in the following line.

#### Firmware Settings

The settings and the upgrade process is described in the [Firmware Upgrade of TPS\(2\) Ports](#) section.

#### Remote Device (valid only for certain extenders)

TPS boards can display the name of the remote Lightware device which is displayed in the TPS Link section. Click on the Open remote device settings button to open a new window:

**Output 18 - Output18**  
MX-TPS2-OB-AP

Apply changes to:  Current output  All outputs

**Set Signal Properties**

Mode:

HDCP:

Power 5V mode:

Audio mode:

**Display**

HDMI capable: Yes  
HDCP capable: Yes  
HDCP repeater: No  
Audio capabilities: Yes  
Supported colorspace: RGB YUV 4:4:4 YUV 4:2:2  
Supported PCM frequencies: 48 kHz  
Display manufacturer: Lightware Visual Engineering  
Display type: RX120-HDSR  
Display resolution: 1920x1080@60.0Hz  
Deep Color support: 30 bit 36 bit  
YUV support on DC: Yes

**TPS Link**

Required mode:   
Actual state: HDBaseT mode  
Remote device: HDMI-TPS-RX120-HDSR  
Power over Ethernet:   
Power over Ethernet status: Disabled  
Please note that changing PoE setting takes effect on this port only!

**Test Pattern Settings**

Test pattern mode:   
Test pattern clock:   
Test pattern:   
Test pattern generator inactive.

**General**

Monitor present (Receiver sense): Present  
Output signal (HDMI/DVI): HDMI  
Active signal: Present

**TPS Card Status**

Ethernet uplink connection: Inactive  
Average board temperature: 28 °C / 82 °F

**TPS Cable Diagnostics**

Pin	Error rate	MSE
1	36	-22 dB
2	34	-22 dB
3	36	-21 dB
4	32	-21 dB

Estimated cable length: <20 m (Cat5) <30 m (Cat7)

Open TPS cable diagnostics

TPS Type Output Port Properties (MX-TPS2-OB-AP)

### 6.5.5. Presets

Preset operations can be done in Crosspoint submenu on the Preset tab. Each Lightware matrix routers has 32 preset memories that can be loaded and saved at any time. #preset

INFO: A preset setting stores a full configuration of all outputs, so preset loading has an effect on every output, except the locked ones.

A preset can be selected by pressing its button on the left. Preset preview (on the right) will show the crosspoint settings of input and output ports.

#### Loading a Preset

- Step 1.** Select the **Presets** tab from Crosspoint menu.
- Step 2.** Select the **preset memory** (Preset1... Preset32) you want to load.
- Step 3.** Press **Load** button below Preset preview list. Now the preset is loaded.
- Step 4.** The new I/O configuration is displayed in Grid view.

#### Saving a Preset

- Step 1.** Make the desired crosspoint connections in Tile view or Grid view.
- Step 2.** Select the **preset memory** (Preset1...Preset32) where you want to save your current crosspoint connections.
- Step 3.** Press **Save** button below Preset preview list.
- Step 4.** A confirmation message is displayed on the information bar; the preset is stored.

#### Renaming a Preset

- Step 1.** Select the **preset memory** (Preset1...Preset32) you want to rename.
- Step 2.** Type the desired name and press **Rename Preset** button; the new name is stored.

The screenshot displays the 'Presets' tab in the Lightware software. The top navigation bar shows 'ETH', 'MX-FR33', '3C019947', 'Crosspoint', 'EDID', and 'Settings'. Below this are tabs for 'Grid view', 'Tile view', and 'Presets'. The main area is divided into 'Presets' (a grid of 32 buttons labeled Preset1 to Preset32) and 'Preset Preview' (a table showing output and input connections for 13 outputs). At the bottom, there is a 'Preset name' field with 'Preset1', a 'Rename Preset' button, 'Save' and 'Load' buttons, and a 'Terminal' button.

Output	Input
1 - Output1 (M)	1 - not connected
2 - Output2	2 - Input1
3 - Output3	3 - Input1
4 - Output4	4 - Input1
5 - Output5	5 - Input1
6 - Output6	6 - Input1
7 - Output7	7 - Input1
8 - Output8	8 - Input1
9 - Output9	9 - Input1
10 - Output10	10 - Input1
11 - Output11	11 - Input1
12 - Output12	12 - Input1
13 - Output13	13 - Input1

Presets Tab



## 6.6. EDID Menu

The Advanced EDID Management is available in the EDID menu. There are two panels: left one contains Source EDIDs, right one contains Destination places where the EDIDs can be emulated or copied.

### 6.6.1. Sources and Destinations

The EDID memory consists of four parts:

- **Factory EDID** list shows the pre-programmed EDIDs (F1-F119).
- **Dynamic EDID** list shows the display device connected to the device's outputs. The unit stores the last display devices' EDID on either output, so there is an EDID shown even if there is no display device attached to the output port at the moment.
- **User memory** locations (U1 – U12) can be used to save custom EDIDs.
- **Emulated EDID** list shows the currently emulated EDID for the inputs. The source column displays the memory location that the current EDID was routed from.

The source reads the EDID from the Emulated EDID memory on the INPUT port. Any EDID from any of the User/Factory/Dynamic EDID lists can be copied to the user memory.









There are two types of emulation: static and dynamic.

- **Static EDID emulation:** an EDID from the Factory or User EDID list is selected. Thus, the Emulated EDID remains the same until the user emulates another EDID.
- **Dynamic EDID emulation:** it can be enabled by selecting D1 or D2 EDID memory. The attached monitor's EDID is copied to the input; if a new monitor is attached to the output, the emulated EDID changes automatically.

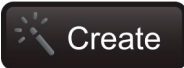

EDID Menu

### Control Buttons

- |   |                                      |   |   |  |  |
|---|--------------------------------------|---|---|--|--|
|  <b>Export</b> | Exporting an EDID (save to a file)   |  <b>Edit</b>   | Opening the Advanced EDID Editor with the selected EDID |  <b>Delete selected</b> | Deleting an EDID (from the User memory)                |
|  <b>Import</b> | Importing an EDID (load from a file) |  <b>Create</b> | Opening Easy EDID Creator                               |  <b>Select All</b>      | Selecting all memory places in the right panel         |
|  <b>Info</b>   | Displaying the EDID Summary window   |                | Executing EDID emulation or copying (Transfer button)   |  <b>Select none</b>     | Selecting none of the memory places in the right panel |

## 6.6.2. EDID Operations

### Changing the Emulated EDID

- Step 1.** Choose the desired **EDID list** (source panel) and select an EDID.
- Step 2.** Press the **Emulated** button on the top of the Destination panel.
- Step 3.** Select the desired **ports** on the right panel (one or more ports); the EDID(s) will be highlighted with a yellow cursor.
- Step 4.** Press the **Transfer** button to change the emulated EDID.

### Learning an EDID

The process is the same as changing the emulated EDID; the only difference is the Destination panel: press the **User** button. Thus, one or more EDIDs can be copied into the user memory either from the factory memory or from a connected sink (Dynamic).

### Exporting an EDID

**ATTENTION!** This function is working on Windows and mac OS X operating systems and under Firefox or Chrome web browsers only.

Source EDID can be downloaded as a file (\*.bin, \*.dat or \*.edid) to the computer.

- Step 1.** Select the desired **EDID** from the Source panel (the line will be highlighted with yellow).
- Step 2.** Press the **Save** button to open the dialog box and save the file to the computer.

### Importing an EDID

Previously saved EDID (\*.bin, \*.dat or \*.edid file) can be uploaded to the user memory:

- Step 1.** Press the **User** button on the top of the Source panel and select a memory slot.
- Step 2.** Press the **Upload** button below the Source panel.
- Step 3.** Browse the file in the opening window then press the **Open** button. Browsed EDID is imported into the selected User memory.

**ATTENTION!** The imported EDID overwrites the selected memory place even if it is not empty.

### Deleting EDID(s)

The EDID(s) from User memory can be deleted as follows:

- Step 1.** Press **User** button on the top of the Destination panel.
- Step 2.** Select the desired **memory slot(s)**; one or more can be selected (Select All and Deselect All buttons can be used). The EDID(s) will be highlighted with yellow.
- Step 3.** Press the **Delete selected** button to delete the EDID(s).

## 6.6.3. EDID Summary Window

Select an EDID from Source panel and press **Info** button to display EDID summary.

The screenshot shows the EDID Summary Window interface. On the left, there is a vertical list of EDID categories: General, Power Management, Gamma / Colors, Established Timings, Standard Timings, Preferred Timing Mode, 2nd Descriptor Field, 3rd Descriptor Field, 4th Descriptor Field, CEA General, CEA Video, CEA Audio, CEA Speaker Allocation, CEA HDMI VSDB, CEA HDMI Forum VSDB, CEA YCbCr 4:2:0 VDB, CEA YCbCr 4:2:0 Capability Map, CEA Colorimetry, CEA High Dynamic Range, and CEA Detailed Timing Descriptors. On the right, the 'General' summary is displayed with the following details:

EDID version:	1
EDID revision:	3
Manufacturer ID:	SAM (Samsung Electric Company)
Product ID:	8E09
Monitor serial number:	Not present
Year of manufacture:	2012
Week of manufacture:	9
Signal interface:	Digital
Separate Sync H&V:	-
Composite sync on H:	-
Sync on green:	-
Serration on VS:	-
Color depth:	Undefined
Interface standard:	Not defined
Color spaces:	RGB 4:4:4 & YCbCr 4:4:4
Aspect ratio:	0.56
Display size:	52 cm X 29 cm

*EDID Summary Window*



### 6.6.4. Editing an EDID

Select an EDID from Source panel and press Edit button to display Advanced EDID Editor window. The editor can read and write all descriptors, which are defined in the standards, including the additional CEA extension. Any EDID from the device's memory or a saved EDID file can be loaded into the editor.

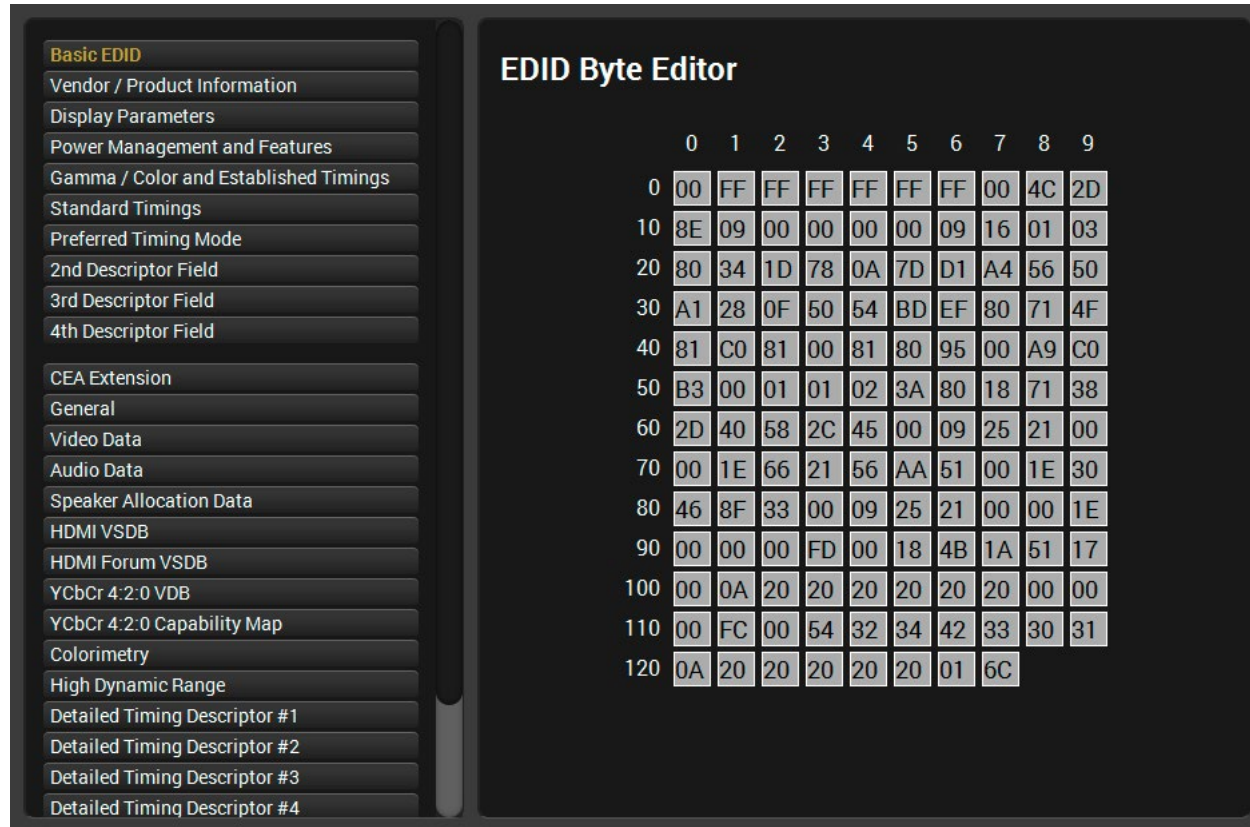

*The EDID Editor Window*

The software resolves the raw EDID and displays it as readable information to the user. All descriptors can be edited, and saved in an EDID file, or uploaded to the User memory. For more details about EDID Editor please visit our website ([www.lightware.com](http://www.lightware.com)) and download EDID Editor user's manual.

### 6.6.5. Creating an EDID

Since above mentioned Advanced EDID Editor needs more complex knowledge about EDID, Lightware introduced a wizard-like interface for fast and easy EDID creation. With Easy EDID Creator it is possible to create custom EDIDs in four simple steps.

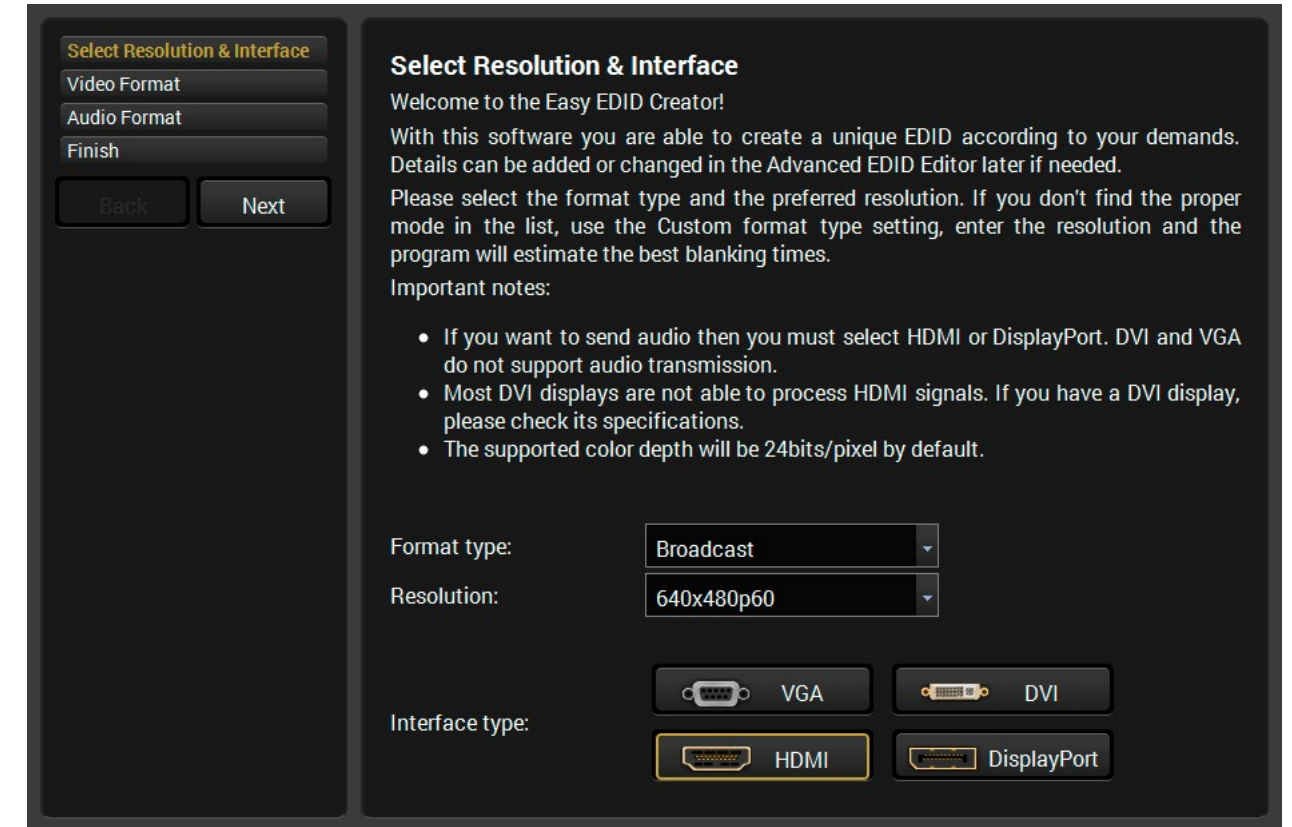

*The Easy EDID Creator Window*

By clicking on the **Create** button below Source panel, Easy EDID Creator is opened in a new window. For more details about EDID Editor please visit our website ([www.lightware.com](http://www.lightware.com)) and download EDID Editor user's manual.



## 6.7. Settings Menu

### 6.7.1. Configuration Tab

Communication settings are available on this tab.

INFO: Load default button restores the default network settings in the device. The default network settings can be found in the [Factory Default Settings](#) section.

INFO: When the serial port is used for the connection, these settings cannot be changed.

#### IP Configuration

The IP address and TCP/IP port can be set up here. `#ipaddress`

**Obtain IP Address Automatically** `#dhcp #network`

By selecting the **Obtain IP address automatically** option, the matrix gets the IP address from the DHCP server on the LAN, or if DHCP server is not present, it gets an AutoIP address from 169.254.xxx.xxx domain. Set BOOTP, DHCP and AutoIP settings according to your network requirements. Always press the Apply settings button to save changes.

#### Fix IP Configuration

In this case, the connected device has an IP address configuration set up by the user/administrator. Depending on modified settings, you might need to restart the device and the LDC Software. Always press the **Apply settings** button to save changes.

#### TCP Port Configuration

Devices can be accessed via this TCP/IP port number with TCP connection. Port number can be modified to any number between 1025 and 65535 except the followings: 9999, 14000 - 14009, 30704, and 30718. To use a matrix with Barco Encore set the port to 23. To use a matrix with Vista Spyder set the port to 10001. Always press the **Apply settings** button to save changes.

#### Serial Port Configuration

The Baud rate for serial connection can be set by the drop-down list: 9600, 19200, 38400, 57600, or 115200. Always press the **Apply settings** button to save changes. `#rs232 #rs-232 #serial`

#### Date/time Settings

The matrix router has a built-in real time clock on the MX-CPU2 processor board. The date/time code is used for the event log entries. The exact date/time values can be set in this section. `#time`

The screenshot displays the Configuration Tab of the Lightware Device Controller Software. The interface is organized into several sections:

- IP Configuration:** Offers two main options: "Obtain IP address automatically" and "Fix IP configuration". Under "Obtain IP address automatically", there are sub-options for "Auto Configuration Methods" including BOOTP, DHCP, and AutoIP, each with "Enable" and "Disable" radio buttons. The "Fix IP configuration" section includes fields for "IP address" (192.168.0.20), "Subnet mask" (255.255.255.0), and "Default gateway" (192.168.0.1). Buttons for "Load default" and "Apply settings" are located below these options.
- TCP Port Configuration:** Features a "TCP port number" field set to 10001, with a note: "(for Barco Encore set Port 23; for Vista Spyder set Port 10001)". It includes "Load default" and "Apply settings" buttons.
- Serial Port Configuration:** Includes a "Serial baudrate" dropdown menu set to 57600 and an "Apply settings" button.
- Date / time Settings:** Contains a "Set current date / time (YYYY/MM/DD HH:MM)" field with inputs for year (1970), month (11), day (19), hour (19), and minute (49), along with a "UTC+0100" dropdown. It also has "Set date & time" and "Synchronize with the local computer" buttons.

The top navigation bar shows "ETH", "MX-FR33", "3C019947", "Crosspoint", "EDID", and "Settings". A "Terminal" button is visible in the bottom right corner.

Configuration Tab

### 6.7.2. Device Information

Basic information about the matrix frame and about the installed boards are listed on this tab:

- CPU board with controllers
- Motherboard type and version
- Input boards with Slot number
- Output boards with Slot number

### 6.7.3. Status

The **Health status** of the matrix frame is displayed on this tab by showing internal measurement values: `#firmwareversion`

- CPU Voltage levels
- Battery cell Voltage level
- Further internally applied Voltage levels
- Internal temperature
- The RPM values of the fans

Press the **Refresh** button to show/update values.

#### Battery Low Alert

The warning shows that the battery on the CPU board is exhausted or not inserted. The function of the battery is powering the real time clock when the frame is powered down. The low battery does not affect normal operation of the matrix. However the error log will not have correct time stamps.

#### Replacement Steps

**Step 1.** Switch off the matrix and take out the MX-CPU2 board. Locate the battery holder. Check if the battery is contacting well in the holder.

**Step 2.** Take the battery out firmly taking care not to bend the spring contact upwards. Bend the spring contact a little bit downwards to ensure good contact.

**Step 3.** If the battery is exhausted, replace with lithium button battery type CR2032.

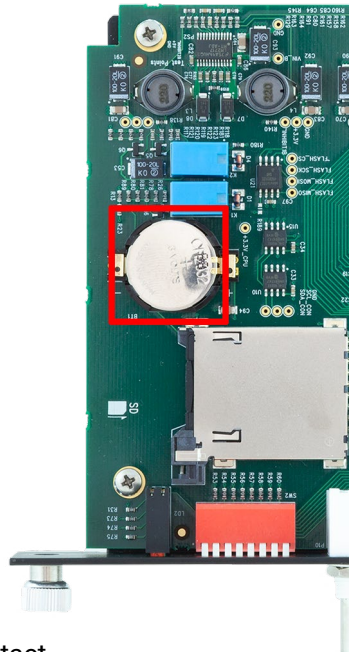

Slot Name	Card Name	Firmware Version	Hardware Version	Serial number
CPU Card	Web Content	FW:1.7.2		
CPU Card	Web Server	FW:4.0.0		
CPU Card	MX-CPU2	FW:3.4.9r	SCH_2.2	1556-ENG
Control Panel	MX-CP	FW:1.0.8		
Control Panel	MX-CP	FW:1.0.8		
MOTHERBOARD	MX-DVI-MB32		SCH_V2.3 PCB_V2.3	3C019947
SLOT 1	MX-HDMI-0B		SCH_1.1 PCB_1.1	SUPHDMI1
SLOT 2	MX-HDMI-3D-0B-H		SCH_1.0 PCB_1.0	48031980
SLOT 3	Empty Slot			
SLOT 4	Empty Slot			
SLOT 5	MX-DVID-IB		SCH_2.0 PCB_2.0	abc126
SLOT 6	MX-HDMI-3D-IB-S		SCH_1.0 PCB_1.0	N/A
SLOT 7	MX-DVI-TP-IB+		SCH_2.1 PCB_2.1	N/A
SLOT 8	Empty Slot			

Device Information Tab

Measurement	Value	Range
CPU 3.3V:	3.32V	[ 3V - 3.6V ]
CPU 5V:	5.05V	[ 4.5V - 5.5V ]
Battery:	2.54V	[ 2V - 3.6V ]
Unregulated 5V:	5.03V	[ 4.5V - 5.5V ]
CPU 12V	11.96V	[ 10V - 14.6V ]
Temperature	25.1C	[ 0C - 50C ]
FAN#1:	1530RPM	[ 400 RPM - 7000 RPM ]
FAN#2:	1470RPM	[ 400 RPM - 7000 RPM ]

Status Tab

### 6.7.4. Log

Events logged by the device and report generators can be found on Log tab. There are two sections: Report and Log viewer.

#### Report Section

**ATTENTION!** This function is working on Windows and Mac OS X operating systems and under Firefox or Chrome web browsers only. Apple Safari is not supported.

LDC is able to collect information from the device and save it to a report file. This information package can be sent to Lightware support team when a problem may arise with the device:

**Step 1.** Press the red button: **Generate report file**.

**Step 2.** LDC collects the information; this may take up to 5 minutes.

**Step 3.** After generating the report, a Save as dialog box appears. Select the folder where you want to save the report file. The default file name can be changed.

The report contains the following device-dependent information:

- Current command protocol,
- Device type and serial number,
- Current crosspoint state,
- Firmware versions of all the internal controllers,
- Installed I/O board types and versions,
- Hardware health status,
- All EDID headers and status (emulated, dynamic, factory, user),
- Basic error list, log file list and last detailed error log.

#### Generate Report From File

The LDC is able to send a custom command file to matrix routers. The command file can be generated by Lightware support. This is needed when some special commands have to be used for configuring the device or troubleshooting.

**INFO:** This function is only for special troubleshooting cases.

#### Error Log Viewer

Log files saved by the matrix can be downloaded and viewed with this function. The columns in the list are the followings: error level, time, error code, error parameter, processor task identifier, occurrences and extra information.

Nr	Level	Time	Code	User Information
Next Startup				
3	Notice	07.03.2017.07:22:34 UTC+25864	SHUTDOWN	Date of last system shutdown is: 06.03.2017 15:59:37
4	Notice	07.03.2017.07:22:35 UTC+0100	BOOT_LT	Booting Information.
5	Notice	07.03.2017.07:22:35 UTC+0100	BOOT_LSC	Booting Information.
6	Notice	07.03.2017.07:22:35 UTC+0100	BOOT_LSCP	Booting Information.
7	Notice	07.03.2017.07:22:35 UTC+0100	BOOT_TSK	Booting Information.
8	Notice	07.03.2017.07:22:35 UTC+0100	BOOT_TSK	Booting Information.
9	Notice	07.03.2017.07:22:35 UTC+0100	BOOT_TSK	Booting Information.
10	Notice	07.03.2017.07:22:35 UTC+0100	BOOT_TSK	Booting Information.
11	Notice	07.03.2017.07:22:35 UTC+0100	BOOT_TSK	Booting Information.

#### Status Tab

The device creates a new error log file every time it is started except if a log file exists for that day. The software allows selecting only those months and days, which have a log.

**Step 1.** Select the month of the error log.

**Step 2.** Select the day.

**Step 3.** The error log is downloaded and shown as a table.

**Step 4.** The error log can be saved in a CSV file on the computer by the Export to CSV file button.

There are two viewing modes are available:

- **User information:** the data is displayed in a structured, user-friendly way; this is the recommended mode.
- **Debug:** Raw data display for special troubleshooting cases.

Logs can be deleted one-by-one or all the logs at the same time with the **Delete all logs** and **Delete this log** buttons.



### 6.7.5. User Preferences

The tab shows some settings in connection with the LDC displaying/working mode. These settings are saved by the LDC and applied next time when the software is started (independently from the type of the matrix):

- Default crosspoint view (Grid view / Tile view)
- Default view on Tile view (View mode / Input switch / Output switch)
- Default Autotake state (On / Off)
- Confirm **Switch All** operation (On / Off)

**INFO:** The size of the LDC window is also restored from the last run.

### 6.8. Terminal Window

This general purpose terminal is intended mainly for testing and debugging purposes. When a successful connection is established with a router this terminal can be used either via serial RS-232, TCP/IP LAN or USB connection. All commands can be used here that are discussed in the programmer's reference. The command text can be typed directly.

By default commands are automatically surrounded by framing brackets. Every sent command and every received response gets an arrow (-> or <-) prefix, and has different font colors in order to help to distinguish.

The timecode in every row shows the exact time when the command was sent or the response received.

If the **Command framing** checkbox is unchecked, you can send multiple commands together, however in this case you have to type in the framing brackets manually.

The terminal can be also opened after starting the LDC - press the Terminal button on the Device discovery page on the bottom of the window.

**TIPS AND TRICKS:** The typed commands can be 'browsed' when the cursor is in the command line and you press the up button on the keyboard. The commands are stored until the LDC is closed.

*#terminal*

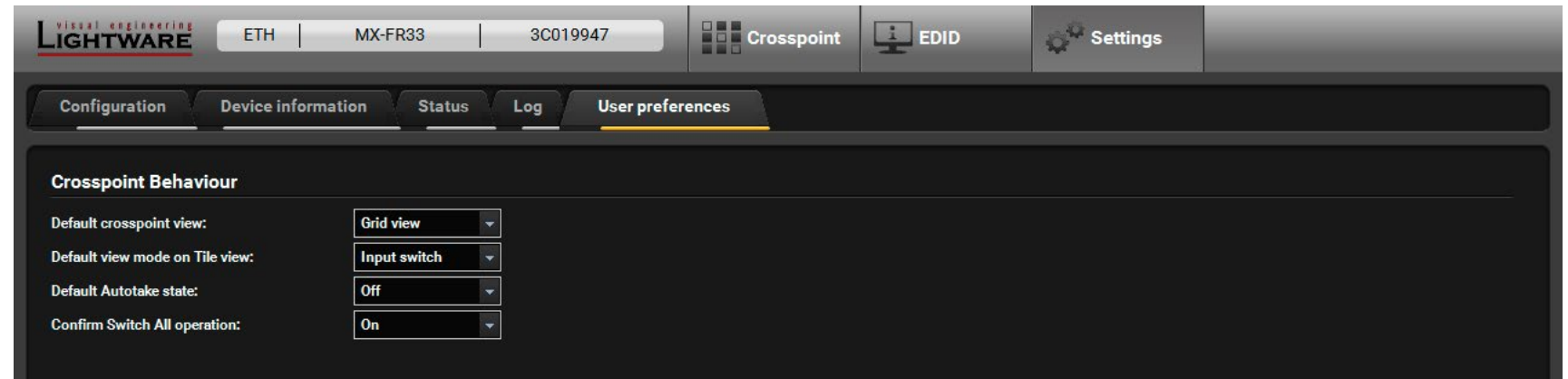

User Preferences Tab



Terminal Window

# 7

## Programmer's Reference

The user can connect to the matrix through Ethernet, serial port or USB. After establishing the connection, there is no difference between connection types (except some rare cases, which are uniquely noted). Lightware matrix routers can be controlled with external devices which can communicate according to the router protocol. Lightware routers have a special protocol, but to interoperate with third-party devices, a secondary protocol is also provided. The supported LW2 commands are described in this chapter:

- ▶ [PROTOCOL DESCRIPTION](#)
- ▶ [STORAGE MEMORIES](#)
- ▶ [SWITCHING AND CONTROL COMMANDS](#)
- ▶ [COMMUNICATION SETUP COMMANDS](#)
- ▶ [ROUTER STATUS COMMANDS](#)
- ▶ [SYSTEM COMMANDS](#)
- ▶ [EDID ROUTER COMMANDS](#)
- ▶ [PORT STATUS COMMANDS](#)
- ▶ [I/O PORT COMMANDS](#)
- ▶ [RICOD RELATED COMMANDS](#)
- ▶ [RS-232 OVER FIBER COMMANDS](#)
- ▶ [RS-232 OVER TPS COMMANDS](#)
- ▶ [ROUTER INITIATED COMMANDS](#)
- ▶ [COMMANDS – QUICK SUMMARY](#)

### 7.1. Protocol Description

The protocol description hereinafter stands for Lightware protocol. The commands can be sent to the device in RAW format via the TCP/IP port no. 10001.

The matrix routers accept commands surrounded by curly brackets - {} - and responds data surrounded by round brackets - () - only if a command was successfully executed. All input commands are converted to uppercase, but respond commands can contain upper and lower case letters as well.

#### 7.1.1. Legend for Control Commands

Format	Explanation
<in>	Input number in 1 or 2 digit ASCII format (01, 5, 07, 16, etc.)
<out>	Output number in 1 or 2 digit ASCII format
<in/out>	input or output port number in 1 or 2 digit ASCII format *
<in2>	Input number in 2 digit ASCII format (01, 02, 10, 12 etc.)
<out2>	Output number in 2 digit ASCII format (01, 02, 10, 12 etc.)
<in2/out2>	input or output number in 2 digit ASCII format*
<loc>	Location number in 1, 2 or 3 digit ASCII format
<id>	id number in 1 or 2 digit ASCII format
<id2>	id number in 2 digit ASCII format
CrLf	Carriage return, Line feed (0x0D, 0x0A)
·	Space character (0x20)
→	Each command issued by the controller
←	Each response received from the router
<S/C/A>	Referring to the I/O card specific commands; <b>S</b> : single port, <b>C</b> : all ports of the card, <b>A</b> : all (input or output) ports of the matrix

\* The command has the same arguments on the input ports and the output port, as well.

#### 7.1.2. Renewed Protocol

The MX-CPU2 processor board works with a similar but renewed protocol as the earlier generation matrix frames with 'CPU1'. The affected commands which are heavily modified in the MX-CPU2 are marked.

#### 7.1.3. Changing Protocols

The router is equipped with multiple router protocols. Different control interfaces can be set to use different protocols. E.g. the Ethernet interface can use the Lightware protocol while the Serial interface uses Protocol#2 at the same time. The currently used protocol can be viewed or changed any time on the matrix front panel (see the [Control Protocols](#) section) or by protocol commands.

## 7.2. Storage Memories

The matrix stores many configuration settings and parameters and uses different memories. In some cases, it is important to know which setting is stored in which memory.

### 7.2.1. Matrix Frame Memory

#### Settings

- Matrix router serial number
- HDCP options
- I/O slot limits

These settings are stored in matrix frame memory and remain after any board swap(ing) – even CPU2 – or any firmware upgrade.

### 7.2.2. CPU Board Memory

#### Settings

- I/O port and preset names
- EDID lists (F, U, D)
- EDID emulation table (E)
- Input and Output port settings
- Crosspoint settings and Crosspoint presets
- Serial port settings
- IP settings
- Analog video timings
- Test input multiplexer (FR80)
- Protocol modes
- Remote alert send levels

These settings remain unchanged after any firmware upgrade.

#### Basic error list

This error list is stored in a RAM and it is cleared after by every reset or power off. Since the firmware upgrade process ends with a reset so the log is lost, but the whole logged data is stored in the SD card, as well.

### 7.2.3. SD Memory Card (CPU2 Board)

#### Settings: Detailed error list

Error log helps the support team if there is any dysfunction. CPU2 board stores the error log with time stamps.

### 7.2.4. Input and Output Board Memory

#### Settings: Manufacturing parameters

An input or output board can store the manufacturing parameters which regards only that board which contains them.

## 7.3. Switching and Control Commands

### 7.3.1. Test Input and Preview Output

#### MX-FR80R and MX-FR65R

Used in the MX-FR80R or MX-FR65R router frame, the Preview output is directly connected to the 80th output port with a DVI splitter. Therefore this port always outputs the same signal as the 80th output, even if it has a different interface (TP, OPT, etc.). The 80th input port of the crosspoint is multiplexed between the Test input port and the 8th port of the 10th input card. This switch is independent from the crosspoint state. The selected port (Test input or Input board #10) will be available as the 80th input on the crosspoint switch.

#### Other Frames

All other frames use the Test input and Preview output just like any other ports. These ports are referred as the last port in the crosspoint.

Frame	Test input	Preview output
MX-FR9, MX-FR9R	in 9	out 9
MX-FR17, MX-FR17R	in 17	out 17
MX-FR33L, MX-FR33R	in 33	out 33
MX-FR65R	in 80	out 80
MX-FR80R	multiplexed in 80	distributed out 80

### 7.3.2. Selecting the 80th Input Port (MX-FR80R)

**DIFFERENCE:** This function has been heavily modified in MX-CPU2 compared to CPU1.

Configure the 80th port to use the Test input port or the 8th port of the 10th input card. The status of the multiplexer is not shown in other crosspoint commands. The crosspoint switching works independently from this setting.

#### Command and Response

```
→ {TI=<value>}
← (TI=<value>)CrLf
```

#### Parameters

Identifier	Parameter description	Parameter values
<value>	Test input configuration	? : Query 80th port multiplexer status 0 : Set port multiplexer to use the 8th port of the 10th input card. 1 : Set port multiplexer to use the Test input port.

#### Example

```
→ {ti=?}
← (TI=1)CrLf
```

The test input is selected for the 80th input of crosspoint. The last port on the 10th input board is not used.



### 7.3.3. Switching an Input to an Output

#### Command and Response 1# #switch

```
→ {<in>@<out>}
← (O<out2>•I<in2>)CrLf
```

#### Example

```
→ {1@5}
← (O05 I01)CrLf
```

Input 1 is switched to output 5.

#### Command and Response 2#

```
→ {<in>@<out>}
← (1LO<out2>)CrLf
```

#### Example

```
→ {2@4}
← (1LO04)CrLf
```

Input 2 to output 4 switch is not made because output 4 is locked.

**ATTENTION!** The response for this command does not show if the output is muted. To check the mute status a separate query has to be used like {VC}; see the [Displaying the Current Connection States of the Outputs](#) section.

INFO: To achieve multiple switches executed together, see the [Batch Switch Outputs](#) section.

### 7.3.4. Switching an Input to All Outputs

#### Command and Response

```
→ {<in>@0}
← (I<in2>•ALL)CrLf
```

#### Example

```
→ {02@0}
← (I02 ALL)CrLf
```

Input 2 is switched to all outputs.

INFO: The response for this command does not show if any of the outputs are muted. To check the mute status a separate query has to be used.

INFO: The response does not show if there were some locked outputs which cannot be switched.

### 7.3.5. Diagonal Switching

This command switches all outputs to the same numbered inputs. Output 1 will be switched to the Input 1, Output 2 to Input 2, etc.

#### Command and Response

```
→ {<in>@D}
← (ALL.<out2>.<out2>...<out2>.<out2>)CrLf
```

#### Example

```
→ {1@d}
← (ALL 01 02 03 04 05 06 07 08 09 10 11 12 13 14 15 16 17)CrLf
```

The example shows how to connect video outputs to the same numbered inputs. The response contains all the connections.

### 7.3.6. Batch Switch Outputs

**DIFFERENCE:** This function has been heavily modified in MX-CPU2 compared to CPU1.

The router is capable of switching multiple outputs exactly at the same time. To do this, the normal switch commands have to be used. If the switch commands arrive at the router with less than 10 milliseconds delay, then the router collects the commands and changes the output connections together.

#### Required circumstances

- Switch commands have this format: {<in>@<out>}{<in>@<out>}
- The delay between two '}' characters must be below 10 milliseconds.
- No other command or junk character is allowed between switch commands.
- Affected outputs must not be locked.

If any of the above circumstances fail, then the commands will be processed separately and the output connections will change on by one.

**ATTENTION!** The delay timeout applies for the receiving time of characters. Please note that if LAN connection is used then the network may cause additional delays. This could result that batch switching does not occur.

Below example shows a command that resulted batch switching:

One by one commands	Batch commands
<pre>→ {02@01} ← (001 I02)CrLf → {05@04} ← (004 I05)CrLf</pre>	<pre>→ {02@01}{05@04} ← (001 I02)CrLf ← (004 I05)CrLf</pre>

The below example shows a command that does not result in batch switching because another command has been inserted:

One by one commands	Batch commands
→ {02@01}	→ {02@01}{+06}{05@04}
← (001 I02)CrLf	← (001 I02)CrLf
→ {+06}	← (0MT06)CrLf
← (0MT06)CrLf	← (004 I05)CrLf
→ {05@04}	
← (004 I05)CrLf	

INFO: The response does not show if batch switching happened or not. This assures that a third party controller does not get unknown responses.

### 7.3.7. Displaying the Current Connection States of the Outputs

**DIFFERENCE:** This function has been heavily modified in MX-CPU2 compared to CPU1.

Viewing all outputs' connection results in different response length, because it depends on the frame size. The response below supposes a router having 17 outputs.

INFO: The MX-CPU2 responds the connection of Preview Output port as well. The earlier 16x16 or 32x32 frames responded 16 and 32 outputs but with MX-CPU2 the response will be 17 and 33 correspondingly.

#### Command and Response *#crosspoint*

```
→ {VC}
← (ALL<01>•<02>•<03>•<04>•<05>•<06>•<07>•<08>•<09>)CrLf
```

#### Example #1 (MX-FR9)

```
→ {vc}
← (ALL 02 02 02 05 05 05 08 08 08)CrLf
```

#### Parameters

All <Ox> indexes show the corresponding output's connection state. If value <05> equals 04 it means that output 5 is connected to input 4. All <Ox> indexes are two digit ASCII characters (01, 02, 04, etc.).

#### Explanation

Viewing connection for all outputs. Input 2 is connected to outputs 1, 2 and 3. Input 5 is connected to outputs 4, 5 and 6. Input 8 is connected to outputs 7 through 17.

INFO: If an output is locked, muted, or both locked and muted, the response format changes. If outputs are muted you get a letter 'M', if locked a letter 'L' and if muted and locked at the same time 'U' before the 2 digit numbers.

#### Example #2 (MX-FR17)

```
→ {vc}
← (ALL M02 L02 U02 05 05 05 08 08 08 08 08 08 08 08 08 08)CrLf
```

#### Parameters

Any <Ox> indexes can be a two digit number, or there can be a leading character showing the mute and/or lock state for the corresponding output.

Identifier	Parameter description	Parameter values
<Ox>	Output port number	<b>&lt;in2&gt;:</b> <Ox> is connected to <in2>, <Ox> neither muted nor locked. <b>M&lt;in2&gt;:</b> <Ox> is connected to <in2>, <Ox> is muted, and unlocked. <b>L&lt;in2&gt;:</b> <Ox> is connected to <in2>, <Ox> is not muted, but locked. <b>U&lt;in2&gt;:</b> <Ox> is connected to <in2>, <Ox> is muted and locked.

#### Explanation

Viewing connection for all outputs. Input 2 is connected to outputs 1, 2 and 3. Output 1 is muted. Output 2 is locked. Output 3 is muted and locked. Input 5 is connected to outputs 4, 5 and 6. Input 8 is connected to outputs 7 through 16.

### 7.3.8. Listing the Mute/Unmute States of All Outputs

**ATTENTION!** The response length depends on the frame size.

#### Command and Response (MX-FR9)

```
→ {VM}
← (MUT<M1>•<M2>•<M3>•<M4>•<M5>•<M6>•<M7>•<M8>•<M9>)CrLf
```

#### Parameters

All <Mx> indexes are one digit numbers, showing the mute state for the corresponding output. If <Mx> equals 0 the output x is unmuted. If <Mx> equals 1, the output x is muted.

#### Example (MX-FR9)

```
→ {vm}
← (MUT 1 0 1 1 0 0 0 0)CrLf
```

Output 1, 3 and 4 are muted, the other outputs are not muted.

### 7.3.9. Muting a Specified Output

Mute output <out>. The output signal is turned off. *#mute*

#### Command and Response

```
→ {#<out>}
← (1MT<out2>)CrLf
```

#### Example

```
→ {#03}
← (1MT03)CrLf
```

Output 3 is muted. No signal is present on output 3 now.

INFO: Muting does not change the crosspoint's state but disables the output itself. This way, the last connection can be easily restored with an unmute command.

INFO: Switching a muted output does not unmute the output.

### 7.3.10. Unmuting a Specified Output

#### Command and Response *#unmute*

```
→ {+<out>}
← (0MT<out2>)CrLf
```

#### Example

```
→ {+03}
← (0MT03)CrLf
```

Output 3 is unmuted. Now output 3 is switched to the input it was connected to prior to the mute command.

**ATTENTION!** Unmuting an output makes the previous connection active as the crosspoint's state has not been changed with the muting command, only the output was disabled.

### 7.3.11. Disconnecting an Output

Switch an output to a virtual unconnected input. No signal on the output.

#### Command and Response

```
→ {0@<out>}
← (0<out2>•I00)CrLf
```

#### Example

```
→ {0@5}
← (005 I00)CrLf
```

Output 5 is disconnected from the inputs (no input will be connected). Disconnecting acts similar to muting except that the previous connection cannot be restored with an unmute command. A disconnected output can still be muted or unmuted, however, this has no real effect in this case. To make a disconnected output live again another input has to be switched to it.

INFO: The response for this command is (1LO<out2>) if the output is locked.

### 7.3.12. Disconnect All Outputs

Switching all the outputs to a virtual unconnected input. No signal on any output.

#### Command and Response

```
→ {0@0}
← (I00 ALL)CrLf
```

#### Example

```
→ {0@0}
← (I00 ALL)CrLf
```

The outputs are disconnected from the inputs (no input will be connected). Disconnecting acts similar to muting except that the previous connection cannot be restored with an unmute command. A disconnected output can still be muted or unmuted, however, this has no real effect in this case. To make a disconnected output live again another input has to be switched to it.

### 7.3.13. Locking a Specified Output

Lock output <out>. Output's state cannot be changed until unlocking. *#lock*

#### Command and Response

```
→ {#><out>}
← (1LO<out2>)CrLf
```

#### Example

```
→ {#>05}
← (1LO05)CrLf
```

Output 5 is locked.

### 7.3.14. Unlocking a Specified Output

Unlock output <out>. The connection on output can be changed.

#### Command and Response *#unlock*

```
→ {+<out>}
← (0LO<out2>)CrLf
```

#### Example

```
→ {+<03>}
← (0LO03)CrLf
```

Output 5 is unlocked.

INFO: The router issues the above response regardless of the previous state of the output (either it was locked or unlocked).



### 7.3.15. Saving a Preset

Save current crosspoint configuration (output states) to preset <id>. All frames have 32 preset memories.

#### Command and Response #preset

```
→ {$<id>}
← (SPR<id2>)CrLf
```

#### Example

```
→ {$4}
← (SPR04)CrLf
```

Current crosspoint state is saved to preset 4, including the mute state of the outputs.

**ATTENTION!** Lock states are not saved. Lock state is assigned to the physical output of the router. Presets do not affect output locks.

### 7.3.16. Loading a Preset

Load crosspoint configuration from preset <id>.

#### Command and Response

```
→ {%<id>}
← (LPR<id2>)CrLf
```

#### Example

```
→ {%4}
← (LPR04)CrLf
```

Current crosspoint state is changed according to preset 4, including the mute state of the outputs.

**INFO:** Locked outputs are left unchanged. Presets do not affect output locks.

### 7.3.17. Preset Preview

The preview of the stored preset <id> without loading it. The response depends on the crosspoint size.

#### Command and Response

```
→ {VP#<id>=?}
← (VP#<id>=•<01>•<02>•<03>•<04>•<05>•<06>•<07>•<08>•<09>)CrLf
```

#### Parameters

Identifier	Parameter description	Parameter values
<0x>	Output port number	<b>&lt;in2&gt;</b> : <0x> is connected to <in2>, <0x> is not muted. <b>M&lt;in2&gt;</b> : <0x> is connected to <in2>, <0x> is muted.

#### Example

```
→ {vp#3=?}
← (VP#3= 02 M02 M01 02 02 01 01 01 01)CrLf
```

Viewing connections for preset 3. Input 2 is connected to outputs 1, 2, 4 and 5. Input 1 is connected to all other outputs. Outputs 2 and 3 are muted.

### 7.3.18. Renaming a Preset

#### Command and Response

```
→ {PNAME#<id>= <preset_name>}
← (PNAME#<id>= <preset_name>)CrLf
```

#### Example

```
→ {pname#1=First preset}
← (PNAME#1=First preset)CrLf
```

Preset 1 was named as 'first preset'.

### 7.3.19. Renaming an Input

#### Command and Response

```
→ {INAME#<in>=<input_name>}
← (INAME#<in>=<input_name>)CrLf
```

#### Example

```
→ {iname#3=Media_Player}
← (INAME#3=Media_Player)CrLf
```

Input 3 was named as 'Media\_Player'.

### 7.3.20. Renaming an Output

#### Command and Response

```
→ {ONAME#<out>=<output_name>}
← (ONAME#<out>=<output_name>)CrLf
```

#### Example

```
→ {oname#2=Monitor#2}
← (ONAME#2=Monitor#2)CrLf
```

Output 2 was named as 'Monitor#2'.

### 7.3.21. Querying the Name of a Preset

#### Command and Response #preset

```
→ {PNAME#<id>=?}
← (PNAME#<id>= <preset_name>)CrLf
```

#### Example

```
→ {pname#1=?}
← (PNAME#1=First_preset)CrLf
```

Name for preset 1 is 'First\_preset'.

### 7.3.22. Querying the Name of an Input

#### Command and Response

```
→ {INAME#<in>=?}
← (INAME#<in>=<Input_name>)CrLf
```

#### Example

```
→ {iname#1=?}
← (INAME#1=PC_1)CrLf
```

Name for input 1 is 'PC\_1'.

### 7.3.23. Querying the Name of an Output

#### Command and Response

```
→ {ONAME#<out>=?}
← (ONAME#<out>=<output_name>)CrLf
```

#### Example

```
→ {oname#2=?}
← (ONAME#2=Monitor_2)CrLf
```

Name for output 1 is 'Monitor\_2'.

### 7.3.24. Reloading the Default Preset Names

**ATTENTION!** The <id> field is not relevant here, only has to be a valid one. The command will affect ALL presets disregarding the actual number that was in the command.

#### Command and Response

```
→ {PNAME#<id>=!}
← (PNAME#<id>=Preset<id>)CrLf
```

#### Example

```
→ {pname#2=!}
← (PNAME#2=Preset 2)CrLf
```

All preset names are set to default: 'Preset 1', 'Preset 2', and so on.

### 7.3.25. Reloading the Default Input Names

**ATTENTION!** The <id> field is not relevant here, only has to be a valid one. The command will affect ALL inputs disregarding the actual number that was in the command.

#### Command and Response

```
→ {INAME#<id>=!}
← (INAME#<id>=Input<id>)CrLf
```

#### Example

```
→ {iname#4=!}
← (INAME#4=Input 4)CrLf
```

All input names are set to default: 'Input 1', 'Input 2', and so on.

### 7.3.26. Reloading the Default Output Names

**ATTENTION!** The <id> field is not relevant here, only has to be a valid one. The command will affect ALL outputs disregarding the actual number that was in the command.

#### Command and Response

```
→ {ONAME#<id>=!}
← (ONAME#<id>=Output<id>)CrLf
```

#### Example

```
→ {oname#3=!}
← (ONAME#3=Output 3)CrLf
```

All output names are set to default: 'Output 1', 'Output 2', and so on.

## 7.4. Communication Setup Commands

### 7.4.1. Querying the IP Settings

**DIFFERENCE:** This function has been heavily modified in MX-CPU2 compared to CPU1.

The TCP/IP settings can be retrieved from the router with this command.

**Command and Response**      *#ipaddress*      *#network*

```
→ {IP_CONFIG=?}
← (IP_CONFIG=<id>•<ip_address>•<port>•<mask>•<gateway>)CrLf
```

#### Parameters

Identifier	Parameter description	Default value
<id>	<b>0:</b> fix IP <b>2:</b> DHCP	0
<ip_address>	IP address	192.168.254.254
<port>	TCP/IP port	10001
<mask>	Subnet mask	255.255.0.0
<gateway>	Gateway address	0.0.0.0

#### Example

```
→ {ip_config=?}
← (IP_CONFIG=0 192.168.2.106 10001 255.255.000.000 192.168.002.001)CrLf
```

The router has a fix IP address 192.168.2.106 on the 255.255.0.0 subnet with a gateway on 192.168.2.1 and communicates over TCP port 10001.

### 7.4.2. Reloading the Default IP Settings

This command sets the router to the factory default IP setup.

#### Command and Response

```
→ {IP_CONFIG=!}
← (Changing•IP• configuration...)CrLf
← (DONE!)CrLf or
← (FAILED!)CrLf
```

#### Parameters

After a successful command execution:

Parameter	Default value
IP address	192.168.254.254
TCP/IP port	10001
Subnet mask	255.255.0.0
Gateway address	0.0.0.0

#### Example

```
→ {ip_config=!}
← (Changing IP configuration...)CrLf
← (DONE!)CrLf
```

INFO: This command can be used on all control interfaces (LAN, RS-232, and USB) but the '(DONE!)' response cannot be seen on LAN because the connection is dropped just after the '(Changing IP configuration...)' response.

INFO: Factory default setting can be reloaded by the front panel buttons ([IP Settings](#) section) or via the front panel LCD menu.

### 7.4.3. Setting a Dynamic IP Address (DHCP)

After sending this command the router will inquire IP address with DHCP.      *#dhcp*

#### Command and Response

```
→ {IP_CONFIG=D}
← (Changing•IP• configuration...)CrLf
← (DONE!)CrLf or
← (FAILED!)CrLf
```

#### Parameters

After successful command execution:

Parameter	Value
IP address	Acquired with DHCP
TCP/IP port	Unchanged
Subnet mask	Acquired with DHCP
Gateway address	Acquired with DHCP

#### Example

```
→ {ip_config=D}
← (Changing IP configuration...)CrLf
← (DONE!)CrLf
```

INFO: This command can be used on all control interfaces (LAN, RS-232, and USB) but the '(DONE!)' response cannot be seen on LAN because the connection is dropped just after the '(Changing IP configuration...)' response.

INFO: DHCP setting can be reloaded by the front panel buttons as well or via the front panel LCD menu.



#### 7.4.4. Querying the RS-232 Baud Rate

The RS-232 baud rate can be checked. It works via LAN and RS-232 as well, but if RS-232 is used the command has to be sent with the appropriate baud rate.

**Command and Response** #rs-232 #rs232 #serial

```
→ {RS232BAUD=?}
← (RS232BAUD=<rate>)CrLf
```

##### Example

```
→ {rs232baud=?}
← (RS232BAUD=57600)CrLf
```

The router communicates with 57600 baud on the RS-232 port.

INFO: RS-232 Baud rate can be checked and set on the front panel LCD menu as well.

#### 7.4.5. Changing the RS-232 Baud Rate

**DIFFERENCE:** This function has been heavily modified in MX-CPU2 compared to CPU1.

The RS-232 baud rate can be set. If the RS-232 connection is used, the command has to be sent with the earlier baud rate but the response comes with the new baud rate.

##### Command and Response

```
→ {RS232BAUD=<rate>}
← (RS232BAUD=<rate>)CrLf
```

##### Parameters

The possible values of <rate>: 9600, 19200, 38400, 57600 (default), 115200.

##### Example

```
→ {rs232baud=9600}
← (RS232BAUD=9600)CrLf
```

INFO: RS-232 Baud rate can be checked and set on the front panel LCD menu as well.

#### 7.4.6. Querying the Control Protocol

**DIFFERENCE:** This function has been heavily modified in MX-CPU2 compared to CPU1.

Matrix routers can be controlled with different control protocols. This command queries the active protocol for the used control interface.

**ATTENTION!** Be aware that different control interfaces can be set to use different protocols. E.g. the Ethernet interface can use the Lightware protocol while the Serial interface uses Protocol#2 at the same time.

##### Command and Response

```
→ {P_?}
← (CURRENT·PROTOCOL·=#<protocol>)CrLf
```

##### Parameters

Identifier	Parameter description	Parameter values
<protocol>	Currently active protocol	1: Lightware (default) 2: Protocol #2 3: LW simple (not in use)

##### Example

```
→ {p_?}
← (CURRENT PROTOCOL = #1)CrLf
```

The matrix communicates with Lightware protocol.

The response shows only the active protocol for the interface that was used to send the command. Control protocol for each interface can be checked by the front panel buttons (see the [Control Protocols](#) section) or in the front panel LCD menu.

#### 7.4.7. Changing the Control Protocol

**DIFFERENCE:** This function has been heavily modified in MX-CPU2 compared to CPU1.

Matrix routers can be controlled with different control protocols. This command sets the active protocol only for the currently used control interface. The setting applies only for the interface that was used to send the command! The USB interface always uses the Lightware protocol, this cannot be changed.

##### Command and Response

```
→ {P_<protocol>}
← (PROTOCOL·#<protocol>·SELECTED!)CrLf
```

##### Parameters

Identifier	Parameter description	Parameter values
<protocol>	Currently active protocol	1: Lightware (default) 2: Protocol #2 3: LW simple (not in use)

**Example**

```
→ {p_1}
← (PROTOCOL #1 SELECTED!)CrLf
```

The matrix communicates with Lightware protocol.

**INFO:** Be aware that different control interfaces can be set to use different protocols. E.g. the Ethernet interface can use the Lightware protocol while the Serial interface uses Protocol#2 at the same time.

**INFO:** The Control protocol can be checked by the front panel buttons or on the front panel LCD menu.

**7.4.8. Configure Remote Alerts**

**DIFFERENCE:** This function has been heavily modified in MX-CPU2 compared to CPU1.

The matrix logs different levels of errors. Configure which level of errors has to be sent out as an alarm message. The matrix will send an immediate message on all control interfaces when a 'matter', 'error' or 'fatal' level error occurs.

**Command and Response**

```
→ {ELEVELSEND#<p>=<0>;<1>;<2>;<3>;<4>}
← (ELEVELSEND#<p>=<0>;<1>;<2>;<3>;<4>)CrLf
```

**Parameters**

Identifier	Parameter description	Parameter values
<p>	Adjusted control interface	<b>0</b> = all <b>1</b> = RS-232 <b>2</b> = LAN <b>3</b> = USB
<0>	'Notice' level events	
<1>	'Warning' level events	
<2>	'Matter' level events	<b>0</b> = no immediate message sent <b>1</b> = immediate message
<3>	'Error' level events	
<4>	'Fatal' level events	

See the [Error Responses](#) section for more information about error levels.

**Example**

```
→ {elevelsend#0=0;0;1;1;1}
← (ELEVELSEND#0=0;0;1;1;1)CrLf
```

**7.5. Router Status Commands****7.5.1. Querying the Product Type**

**DIFFERENCE:** This function has been heavily modified in MX-CPU2 compared to CPU1.

**Command and Response**      #label      #devicelabel

```
→ {}
← (<PRODUCT_TYPE>)CrLf
```

**Example**

```
→ {}
← (I: MX-FR17)CrLf
```

**INFO:** Please note that MX-FR65R gives (I:MX-FR80R) response.

**7.5.2. Querying the Serial Number**

The device responds its 8-digit serial number.

**Command and Response**

```
→ {S}
← (SN:<SERIAL_NO>)CrLf
```

**Example**

```
→ {s}
← (SN:3C019935)CrLf
```

**7.5.3. Querying the Firmware Version of the CPU**

View the CPU firmware revision. To view other controller's firmware version see the {FC} command.

**Command and Response**

```
→ {F}
← (FW:<FW_VER><s>)CrLf
```

**Example**

```
→ {f}
← (FW:3.4.9r)CrLf
```

<FW\_VER> is the firmware version. It is followed by <s> string which may indicate special versions. <s>=r indicates standard version.

#### 7.5.4. Querying the CPU Firmware Compile Time

##### Command and Response

```
→ {CT}
← (Compiled:<DATE>•<TIME>•Build:<tag>)CrLf
```

##### Parameters

Identifier	Parameter description
<DATE>	Month, day and year
<TIME>	Hours, minutes and seconds
<tag>	Identification number of the firmware

##### Example

```
→ {ct}
← (Compiled:May 10 2012 16:36:35 Build:3564)CrLf
```

#### 7.5.5. Querying the Crosspoint Size

The response shows the physical crosspoint size.

##### Command and Response

```
→ {GETSIZE}
← (SIZE=<size>)CrLf
```

##### Parameters

<size> parameter can be 17x17, 33x33 or 80x80.

##### Example

```
→ {getsize}
← (SIZE=17x17)CrLf
```

#### 7.5.6. Querying the Number of the Allowed I/O Slots

Checking the allowed number of I/O boards.

##### Command and Response

```
→ {MAXSLOTS=?}
← (MAXSLOTS= IB:<num1>,OB:<num2>)CrLf
```

##### Parameters

<num1> and <num2> are two-digit numbers showing the maximum number of allowed input and output boards correspondingly.

##### Example

```
→ {maxslots=?}
← (MAXSLOTS=IB:01,OB:01)CrLf
```

The router is limited for one input board and one output board (MX-FR9).

#### 7.5.7. Querying the Installed I/O Boards

**DIFFERENCE:** This function has been heavily modified in MX-CPU2 compared to CPU1.

Shows the hardware name and revision of the installed cards. The number of responses varies regarding the frame size (number of slots).

##### Command and Response

```
→ {IS}
← (SL#•0•<MB_DESC>)CrLf
← (SL#•1•<OB_DESC>)CrLf
← (SL#•2•<OB_DESC>)CrLf
...
← (SL#•51•<IB_DESC>)CrLf
← (SL#•52•<IB_DESC>)CrLf
...
← (SL•END)CrLf
```

##### Parameters

Slot 0 represents the motherboard. Slots from 1 to 50 are showing the output boards. Slots from 51 to 100 are showing the input boards.

Identifier	Parameter description
SL# 0	This 'slot' represents the motherboard.
SL# 1-50	Slots from 1 to 50 are showing the output boards.
SL# 51-100	Slots from 51 to 100 are showing the input boards.
SL END	This message indicates the end of the list.

**INFO:** The device responds an 'empty' board descriptor for empty physical slots.

##### Example

```
→ {is}
← (SL# 0 MX-DVI-MB80 SCH_1.1 PCB_1.1)CrLf
← (SL# 1 MX-DVID-OB SCH_2.0 PCB_2.0)CrLf
← (SL# 2 empty)CrLf
...
← (SL# 51 MX-DVID-IB SCH_2.0 PCB_2.0)CrLf
```

The router reports that it has two output and two input slots. There are two input cards and one output card installed, and one output slot is empty.



### 7.5.8. Querying the Firmware of All Controllers'

Shows the firmware versions of all installed controllers. The response depends on the router configuration.

#### Command and Response

```
→ {FC}
← (CF•<DESC>)CrLf
← (CF•<DESC>)CrLf
...
← (CF END)CrLf
```

#### Example

```
→ {fc}
← (CF MX-CPU2 FW:3.4.9r SCH_2.2)CrLf
← (CF MX-CP FW:1.0.8 @ 0x10)CrLf
...
← (CF END) CrLf
```

The matrix has an MX-CPU2 processor. There is a control panel in the frame.

### 7.5.9. Querying the LAN Versions

Shows information about the LAN interface.

#### Command and Response

```
→ {LAN_VER=?}
← (MAC_ADDR=<mac>)CrLf
← (WEB_VER=<ver1>)CrLf
← (SERVER_VER=<ver2>)CrLf
```

#### Example

```
→ {lan_ver=?}
← (MAC_ADDR=00-20-4A-C7-AC-C0)CrLf
← (WEB_VER=1.7.2)CrLf
← (SERVER_VER=4.0.0)CrLf
```

#### Parameters

Identifier	Parameter description
<mac>	MAC address of LAN controller in the matrix.
<ver1>	Version of built-in website user interface (webcontent).
<ver2>	Version of LAN controller firmware (webserver).

MAC address, webcontent and webserver versions are shown.

### 7.5.10. Querying the Health Status

#### Command and Response

```
→ {ST}
← (ST•<DESC>)CrLf
...
← (ST•<DESC>)CrLf
```

#### Example (MX-FR17R) #power

```
→ {st}
← (ST CPU 3.32V 5.03V 3.05V 5.03V 12.11V 31.6C)CrLf
← (ST FAN#1 1530RPM)CrLf
← (ST FAN#2 1530RPM)CrLf
← (ST PS#1=OK)CrLf
← (ST PS#2=OK)CrLf
```

The response depends on the frame type. Internal voltages, temperature and fan speeds shown. The last two rows show the status of the redundant PSUs.

### 7.5.11. Querying the Error List

**DIFFERENCE:** This function has been heavily modified in MX-CPU2 compared to CPU1.

Shows the basic error list since last boot up.

#### Command and Response

```
→ {ELIST=?}
← (ELIST#<num>•<elevel>•<code>•<param>•<occ>)CrLf
← ...
← (ELIST#<num>•<elevel>•<code>•<param>•<occ>)CrLf
```

#### Parameters

Identifier	Parameter description	Parameter values
<num>	Line number	
<elevel>	The level of the error	<b>NOTICE:</b> Not an error, Initialization information <b>WARNING:</b> Possible problem without influencing normal operation <b>MATTER:</b> Problem that may lead to further errors <b>ERROR:</b> Serious error, must report to Lightware support <b>FATAL:</b> Fatal error, normal operation is not possible
<code>	Short name for type of log entry	
<param>	Technical parameter	
<occ>	Occurrence number for this type of log entry	

**Example**

```
→ {elist=?}
← (ELIST#1 Notice BOOT p:2 o:1)CrLf
← (ELIST#2 Notice SERIAL p:0 o:1 )CrLf
← (ELIST#3 Notice CARDINIT p:81 o:1 ) CrLf
← (ELIST#4 Notice CARDINIT p:2 o:1 )CrLf
← (ELIST#5 Notice READY p:0 o:1)CrLf
```

There are no errors only standard notices that occur on boot up.

INFO: The error list can contain NOTICES and WARNINGS under normal operation. These entries do not mean that there is any problem with the matrix!

**7.6. System Commands****7.6.1. Restarting the Matrix**

The matrix router can be restarted without unplugging power.

**Command and Responses** *#reset #restart*

```
→ {RST}
← (Booting...)CrLf
← (<name>•Ready!)CrLf
```

**Parameters**

The matrix reboots and sends a message when it is ready. <name> is the type of the matrix.

**Example**

```
→ {rst}
← (Booting...)CrLf
← (MX-FR17 Ready!)CrLf
```

INFO: The response can be seen only if the connection to the router is still alive.

**7.6.2. Querying the CPU Time**

The matrix router has a built-in real time clock on the MX-CPU2 processor board. This command allows reading the CPU time. *#date #time*

**Command and Response**

```
→ {GETTIME}
← (<date>•<time>•UTC+<zone>)CrLf
```

**Parameters**

See the next section.

**Example**

```
→ {gettime}
← (04.10.2016. 16:52:34 UTC+0100)CrLf
```

### 7.6.3. Setting the CPU Time

This command allows setting the built-in real time clock on the CPU2 board.

#### Command and Response

```
→ {SETTIME=<date>•<time>•UTC+<zone>}
← (<date>•<time>•UTC+<zone>)CrLf
```

#### Parameters

The UTC, and therefore processor time do not observe daylight saving. E.g., the Central European Time is UTC+1 during winter and UTC+2 during summer. The CPU time is used mainly as a timestamp in the error log.

Identifier	Parameter description
<date>	Date in DD.MM.YYYY. format
<time>	Time in HH:MM:SS format
<zone>	Time zone related to UTC (Universal Coordinated Time) in HHMM format.

#### Example

```
→ {settime=15.10.2012. 16:52:34 UTC+0100}
← (15.10.2012. 16:52:34 UTC+0100)CrLf
```

INFO: The MX-CPU2 board has a CR2032 button battery which supplies power to the clock when the matrix is not powered on.

### 7.6.4. Switching the Matrix to Standby

**DIFFERENCE:** This command works only in the MX-FR80R and MX-FR65R. The frame can be switched to standby without unplugging the power. The CPU can still communicate.

#### Command and Response

```
→ {PWR_<state>}
← (Powered <state>)CrLf
```

#### Parameters

The <state> parameter can be OFF or ON.

#### Example

```
→ {pwr_off}
← (Powered off)CrLf
```

INFO: The I/O boards do not get any power when in standby mode. The CPU will still work and respond only for status commands.

### 7.6.5. Reloading the Factory Default Values and Settings

**DIFFERENCE:** This function has been heavily modified in MX-CPU2 compared to CPU1.

Factory default settings can be reloaded for different functions separately. Multiple functions can be entered.

#### Command and Response

```
→ {FACTORY=<f1>;<f2>;...;<fx>}
← (FACTORY•<f1>...)CrLf
← (FACTORY•<f2>...)CrLf
← ...
← (FACTORY•<fx>...)CrLf
```

#### Parameters

<f1>, <f2> are the names of the functions which have to be reset to factory default. Any number of <fx> can be entered, separated by semicolons.

#### Example

```
→ {factory=xpoint;iocards;edids}
← (FACTORY XPOINT...)CrLf
← (FACTORY IOCARDS...)CrLf
← (FACTORY EDIDS...)CrLf
```

Factory default settings reloaded for crosspoint and I/O card configurations and emulated EDIDs. The response may contain additional messages as the router makes the configurations. These responses can be omitted.

INFO: After resetting the needed parameters, the matrix restarts.



## 7.7. EDID Router Commands

**DIFFERENCE:** These functions have been heavily modified in MX-CPU2 compared to CPU1.

The EDID router manipulates the EDID memory, which has memory locations that are assigned to specific input or output ports. Please read [The EDID Memory of a Matrix](#) section about the EDID memory structure.

### 7.7.1. Changing the EDID on an Input Port

Copy an EDID from memory location <source> to input port <destination>. #edid

#### Command and Response

```
→ {<destination>:<source>}
← (E_SW_OK)CrLf
...delay...
← (E_S_C)CrLf
```

<fx>	Restores factory settings to	Additional response
<b>GENERAL</b>	Control protocols, Front panel state, Alarm message levels	none
<b>IOCARDS</b>	All I/O settings for boards currently in the frame	none
<b>XPOINT</b>	Crosspoint table and configuration (All outputs to in1, unmute, unlock)	none
<b>PRESETS</b>	Crosspoint presets (All output to in1, unmuted) and preset names	(PNAME#1=Preset1) (I1 ALL) (SPR01)...(SPR32)
<b>IONAMES</b>	Input and output names	(INAME#1=Input1) (ONAME#1=Output1)
<b>EDIDS</b>	Emulated EDIDs (F49 is default)	none
<b>EDIDMEM</b>	Clear User and Dynamic EDIDs	(DE_OK) (DE_OK)
<b>ALL</b>	Restores all of the factory settings listed above	as above

#### Parameters

Identifier	Parameter description	Parameter values
<destination>	Emulated EDID memory slot	<b>E01-E80</b> *
<source>	Source EDID memory slot	<b>F01-F119:</b> Factory preset EDIDs <b>U01-U50:</b> User saved EDIDs <b>D01-D80:</b> Dynamic EDIDs of connected sinks *

\* the highest value depends on the frame size.

If <source> is 'Fxx' or 'Uxx' then static EDID routing occurs. In this case, the router will keep the same EDID on the input until it is changed with another command. If <source> is 'Dxx' then dynamic EDID routing occurs. In this case, the router will follow the EDID changes on the output. Every time a different EDID is recognized on the output, it is copied instantly to the input.

#### Example

```
→ {e5:f10}
← (E_SW_OK)CrLf
...delay...
← (E_S_C) CrLf
```

Factory EDID #10 is copied to input 5.

**INFO:** The router sends (E\_S\_C) only if the new EDID is different from the earlier one.

### 7.7.2. Changing the EDID on All Inputs

Copy an EDID from memory location <source> to all inputs.

#### Command and Response

```
→ {EA:<source>}
← (E_SW_OK)CrLf
...delay...
← (E_S_C) CrLf
```

#### Parameters

Location <source> can be 'Fxx' or 'Uxx' for static routing and 'Dxx' for dynamic routing. See the details in the previous section.

#### Example

```
→ {pwr_off}
← (Powered off)CrLf
```

User EDID #2 is copied to all inputs.

**ATTENTION!** This operation can take several seconds depending on the frame size.

### 7.7.3. Saving an EDID to the User Memory

Learn EDID from <source> memory location to <destination>.

#### Command and Response

```
→ {<destination>:<source>}
← (E_SW_OK)CrLf
← (E_S_C) CrLf
```

#### Parameters

Location <destination> must be 'Uxx', <source> can be 'Fxx', 'Uxx', Dxx or Exx. See the details in the [Changing the EDID on an Input Port](#) section.

#### Example

```
→ {u4:d3}
← (E_SW_OK)CrLf
← (E_S_C) CrLf
```

EDID from output 3 is saved to user EDID #4.

### 7.7.4. Querying the EDID Validity Table

Shows EDID validity table, which contains information about the EDID memory states.

#### Command and Response

```
→ {WV<type>}•<val_table>)CrLf
← (E_SW_OK)CrLf
```

#### Parameters

Identifier	Parameter description	Parameter values
<type>	Type of the EDID memory	<b>D:</b> Dynamic EDIDs * <b>E:</b> Emulated EDIDs * <b>F:</b> Factory preset EDIDs <b>U:</b> User saved EDIDs (max 50)
<val_table>	The EDID validity for the memory locations from 1 to max value	<b>0:</b> invalid EDID <b>1:</b> valid EDID <b>2:</b> deleted EDID <b>3:</b> changed EDID

\* the highest value depends on the frame size.

#### Example

```
→ {wv*}
← (EVU 00000000000000000000000000000000000000000000000000000000000000000000)CrLf
← (EVD 10001001000000000)CrLf
← (EVE 13111111111111111)CrLf
```

There is a '3' on the second position of the emulated EDID table. This means that the emulated EDID on input 2 is changed since the last EDID query on that port.

**INFO:** If a changed EDID is queried by the {WH} command (see the next section), its value returns to '1'. The status of a deleted EDID returns to '0' after query.

### 7.7.5. Querying the Emulated EDIDs on All Inputs

Shows the currently emulated EDIDs for each input. The response length depends on the frame size (number of inputs). The value at the given index (<in1>..<inx>) shows which EDID is used on that particular input.

#### Command and Response (MX-FR9)

```
→ {VEDID}
← (VEDID<in1>•<in2>•<in3>•<in4>•<in5>•<in6>•<in7>•<in8>•<in9>)CrLf
```

#### Parameters

The <inx> index shows the location of the source EDID.

#### Example

```
→ {vedid}
← (VEDID F049 F049 F049 F049 F049 F049 F049 D004 U002)CrLf
```

F049 (Factory preset EDID #49) is emulated on all inputs except input 8 and 9. EDID from output 4 is dynamically emulated on input 8. U002 (User saved EDID #2) is emulated on input 9.

### 7.7.6. Querying the Header of an EDID

Shows basic information about EDIDs in the memory.

#### Command and Response

```
→ {WH<loc>}
← (EH#<loc>•<header>)CrLf
```

#### Parameters

Depending on <loc> the query can be for one EDID or all EDID in the block.

Identifier	Parameter description	Parameter values
<loc>	Type of the EDID memory	<b>Dxx</b> : Header of one dynamic EDID <b>Exx</b> : Header of one emulated EDID <b>Fxx</b> : Header of one factory EDID <b>Uxx</b> : Header of one User-saved EDID <b>D*</b> : Dynamic EDIDs: headers from all inputs <b>E*</b> : Emulated EDIDs: headers from all outputs <b>F*</b> : Headers of all factory EDIDs <b>U*</b> : Headers of all (50) User-saved EDIDs
<header>	EDID header with 3 fields separated by spaces	<b>PNPID code</b> : The three letter abbreviation of the manufacturer. <b>Preferred resolution</b> : The resolution and refresh rate stored in the preferred detailed timing block. <b>Name</b> : The name of display device stored in product descriptor.

The <header> is '-' for invalid EDIDs.

#### Example

```
→ {whd14}
← (EH#D14 NEC 1280x1024@60 LCD1970NXp)CrLf
```

Shows the EDID from memory location D14 which is the EDID from the Last attached monitor on output 14.

### 7.7.7. Deleting an EDID From the Memory

Clear EDID from memory location <loc>.

#### Command and Response

```
→ {DE<loc>}
← (DE_OK)CrLf
← (E_S_C)CrLf
```

#### Parameters

Depending on <loc>, one EDID or all EDIDs in a block can be cleared.

Identifier	Parameter description	Parameter values
<loc>	EDID block or memory location	<b>Dxx</b> : Specified Dynamic EDID is deleted. It will be empty until a new monitor is connected. <b>Exx</b> : Specified Emulated EDID cleared. By default F49 EDID is copied to it. <b>Fxx</b> : Not valid! Factory EDID cannot be deleted. No response. <b>Uxx</b> : Specified User EDID is deleted. <b>D*</b> : All Dynamic EDIDs are deleted. They will be empty until a new monitor is connected. <b>E*</b> : All Emulated EDIDs are cleared. By default F49 EDID is copied to them. <b>F*</b> : Not valid! Factory EDID cannot be deleted. No response. <b>U*</b> : All User EDIDs are deleted.

#### Example

```
→ {deu*}
← (DE_OK)CrLf
← (E_S_C)CrLf
```

All user EDIDs are cleared from memory.

### 7.7.8. Downloading the Content of an EDID

EDID hex bytes can be read directly. The router will issue the whole content of the EDID present on memory location <loc> (256 bytes).

#### Command and Response

```
→ {WE<loc>}
← (EB#<loc>•<B1>•<B2>•...•<B256>)CrLf
```

#### Parameters

<B1>...<B256> are space separated hex characters represented in ASCII format. For the details of the <> parameters see the [Changing the EDID on an Input Port](#) section.

#### Example

```
→ {wef1}
← (EB#F1 00 FF FF FF FF FF FF 00 32 F2 00 00 00 ... .. 00 00)CrLf
```

Full EDID from memory location F1 is downloaded.

### 7.7.9. Uploading the EDID Content

EDID hex bytes can be written directly to the user programmable memory locations. The sequence is the following:

**Step 1.** Prepare the router to accept EDID bytes to the specified location <loc> with command {WL#<loc>}

**Step 2.** Router responds that it is ready to accept EDID bytes with (E\_L\_S)CrLf

**Step 3.** Send 1 block of EDID (1 block consist of 8 bytes of hex data represented in ASCII format) with command {WB#<num>•<B1>•<B2>•<B3>•<B4> •<B5>•<B6>•<B7>•<B8>}

**Step 4.** The router acknowledges with response (EL#<num>)

**Step 5.** Repeat steps 3 and 4 to send the remaining 31 blocks of EDID (32 altogether)

**Step 6.** After the last acknowledge, the router indicates that the EDID status changed by sending (E\_S\_C) CrLf

#### Command and Response

```
→ {WL#<loc>}
← (E_L_S)CrLf
→ {WB#1•<B1>•<B2>•<B3>•<B4>•<B5>•<B6>•<B7>•<B8>}
← (EL#<num>)CrLf
→ {WB#2•<B9>•<B10>•<B11>•<B12>•<B13>•<B14>•<B15>•<B16>}
← (EL#<num>)CrLf
...
→ {WB#32•<B249>•<B250>•<B251>•<B252>•<B253>•<B254>•<B255>•<B256>}
← (EL#<num>)CrLf
← (E_S_C)CrLf
```

#### Parameters

Identifier	Parameter description	Parameter values
<loc>	User EDID memory location	<b>U01-U50</b>
<num>	Sequential number of every 8 byte part of the EDID	<b>01..32</b>
<B1>...<B256>	EDID data	EDID data bytes in HEX format

#### Example

```
→ {wl#U3}
← (E_L_S)CrLf
→ {WB#1 00 FF FF FF FF FF FF 00}
← (EL#1)CrLf
→ {WB#2 38 A3 8E 66 01 01 01 01}
← (EL#2)CrLf
...
→ {WB#32 36 59 42 0A 20 20 00 96}
← (EL#32)CrLf
← (E_S_C)CrLf
```

Full EDID uploaded to memory location U3.



## 7.8. Port Status Commands

### 7.8.1. Input Port Status

Shows the actual status of the input ports. The response length changes regarding the frame size. The meaning of the values changes regarding the input board types as the boards have different functions and capabilities.

#### Command and Response

→ {:ISD}  
← (ISD•<input\_d>)CrLf

#### Parameters

<input\_d> may contain 9, 17, 33 or 80 hexadecimal numbers. Each number represents the state for the corresponding input port. The meaning of the responded number depends on the actual board (port) type. The binary representation of the responded hexadecimal numbers is shown below.

Board Type	3. bit (MSB)	2. bit	1. bit	0. bit (LSB)
<b>MX-DVID-IB</b>	0	0	0	clock detect
<b>MX-DVI-TP-IB</b>	0	0	0	clock detect
<b>MX-DVI-TP-IB+</b>	0	0	0	clock detect
<b>MX-DVI-OPT-IB</b>	0	0	0	laser + clock
<b>MX-DVIDL-IB</b>	0	0	0	clock detect
<b>MX-DVIDL-OPT-IB</b>	0	0	0	laser + clock
<b>MX-HDMI-IB</b>	0	HDMI mode	signal detect	source 5V
<b>MX-DVI-HDCP-IB</b>	0	HDMI mode	signal detect	source 5V
<b>MX-HDMI-TP-IB</b>	0	HDMI mode	signal detect	source 5V
<b>MXD-HDMI-TP-IB</b>	0	HDMI mode	signal detect	source 5V
<b>MX-HDMI-OPT-IB</b>	HDCP active	HDMI mode	TX detect	clock detect
<b>MX-DVII-HDCP-IB</b>	analog signal	HDCP active	digital signal	source 5V
<b>MXD-UMX-IB</b>	analog signal	HDCP active	digital signal	source 5V
<b>MX-3GSDI-IB</b>	video detect	audio detect	type: 01=SD, 10=HD, 11=3G	
<b>MX-HDMI-3D-IB, -S, -A</b>	HDCP active	HDMI mode	clock detect	source 5V
<b>MX-4K-DVI-IB</b>	HDCP active	HDMI mode	clock detect	source 5V
<b>MX-TPS-IB, -S, -A</b>	HDCP active	HDMI mode	clock detect	TPS link pres.
<b>MX-TPS2-IB-P, -AP, -SP</b>	HDCP active	HDMI mode	clock detect	TPS link pres.
<b>MX-4TPS2-4HDMI-IB, -A, -S</b>	HDCP active	HDMI mode	clock detect	TPS link pres.
<b>MX-4TPS2-4HDMI-IB, -A, -S</b>	HDCP active	HDMI mode	clock detect	source 5V

- **Source 5V:** The connected source sends 5V.
- **Clock detect:** TMDS clock is present.
- **Laser + Clock:** Laser detected and TMDS clock is present.
- **Signal Detect:** Video signal is present (TMDS stream can be recognized).
- **HDMI mode:** The incoming signal is HDMI.
- **HDCP active:** The incoming signal is encrypted.
- **TX detect:** Communication with optical transmitter is OK.
- **Analog signal:** Video signal is present on the analog input.
- **Digital signal:** Video signal is present on the digital input.

#### Example #hdcp

→ {:isd}  
← (ISD 11333777001100000000000000000007)CrLf

The first input board is an HDMI board. Input 1 and 2 have a connected source but no signal. Inputs 3-5 have DVI signals and inputs 6-8 have HDMI signals. The second input board is a DVI board. Input 11 and 12 have DVI signals. The Test Input port has an HDMI signal.

INFO: Both Clock Detect and Signal Detect can be used to check if there is an incoming signal.

### 7.8.2. Output Port Status

Shows the actual status of the output ports. The response length changes regarding the frame size. The meaning of the values changes regarding the output board types as they have different capabilities.

#### Command and Response

→ { :OSD }

← ( OSD • < output\_d > ) CrLf

#### Parameters

< output\_d > may contain 9, 17, 33 or 80 hexadecimal numbers. Each number represents the state for the corresponding output port. The meaning of the responded number depends on the actual board type for that port. The binary representation of the responded hexadecimal numbers is shown below.

Board Type	3. bit (MSB)	2. bit	1. bit	0. bit (LSB)
<b>MX-DVID-OB</b>	0	0	0	receiver sense
<b>MX-DVI-TP-OB</b>	0	0	0	0
<b>MX-DVI-TP-OB+</b>	0	0	0	hotplug detect
<b>MX-DVI-OPT-OB, -R</b>	0	0	0	0
<b>MX-DVIDL-OB</b>	0	0	0	hotplug detect
<b>MX-DVIDL-OPT-OB</b>	0	0	0	0
<b>MX-HDMI-OB</b>	0	0	0	receiver sense
<b>MX-DVI-HDCP-OB</b>	0	0	0	receiver sense
<b>MX-HDMI-TP-OB</b>	0	0	0	1 (fixed)
<b>MXD-HDMI-TP-OB</b>	0	0	0	receiver sense
<b>MX-HDMI-OPT-OB</b>	HDMI mode	HDCP active	RX detect	laser enable
<b>MX-HDMI-OPT-OB-R</b>	0	0	RX detect	laser enable
<b>MX-TPS-OB; -A; -S</b>	0	0	0	TPS link pres.
<b>MX-HDMI-3D-OB; -A; -S</b>	0	0	0	receiver sense
<b>MX-DVI-4K-OB</b>	0	0	0	receiver sense
<b>MX-AUDIO-OB</b>	0	0	0	0
<b>MX-TPS2-OB-P, -AP, -SP</b>	0	0	0	TPS link pres.
<b>MX-4TPS2-4HDMI-OB, -A, -S</b>	0	0	0	TPS link pres.
<b>MX-4TPS2-4HDMI-OB, -A, -S</b>	0	0	0	receiver sense

- **Receiver Sense:** TMDS termination present in the connected device.
- **Hotplug Detect:** Hotplug signal is presented by the connected device.
- **Laser Enable:** Optical transmitter is active on output.
- **RX detect:** Communication with the optical receiver is OK.
- **HDMI mode:** The incoming signal is HDMI.
- **HDCP active:** The incoming signal is encrypted. #hdcp

INFO: Both Receiver Sense and Hotplug Detect can be used to check the attached sink device.

#### Example

→ { :osd }

← ( OSD 01000000101100000000000000000000 ) CrLf

There are four DVI sinks connected to ports 2, 9, 11 and 12, nothing else.

### 7.8.3. All Port Status

Shows the actual status of all input and output ports.

#### Command and Response

→ { PS }

← ( PS • < input\_d > , < output\_d > ) CrLf

#### Parameters

< input\_d > and < output\_d > are the same as for { :ISD } and { :OSD } commands.

#### Example (MX-FR17)

→ { ps }

← ( PS 11333777001100000,01000000101100000 ) CrLf

## 7.9. I/O Port Commands

### 7.9.1. TPS and TPS2 Port

#### 7.9.1.1. Port Parameters and Settings

Query or set the TPS port-related parameters. The format and the usage are the same in the case of the input and output ports.

##### Supported Boards

- *MX-TPS-IB, -A, -S; MX-TPS2-IB-P, -AP, -SP*
- *MX-4TPS2-4HDMI-IB, -A, S; MX-4TPS2-4HDMI-IB-P, -AP, -SP*
- *MX-4TPS2-4HDMI-OB, -A, S; MX-4TPS2-4HDMI-OB-P, -AP, -SP*
- *MX-TPS-OB, -A, -S; MX-TPS2-OB-P, -AP, -SP*

##### Querying the Parameters

###### Command and Response

→ { :TPS#<in/out>@<S><l/O>=? }

← (TPS#<in/out>@<S><l/O>=<mod>;<eth>;<cmode>;<pwr>;<upl>;<qual>;<err>;<len>;<rid>;<tmp>)CrLf

###### Example

→ { :tps#1@so=? }

← (TPS#1@SO=H;1;H;0;0;17161617;23222020;0;0384;38;)CrLf

The state of the 1st output is: HDBaseT mode is selected, Ethernet is enabled.

##### Setting the Parameters

###### Command and Response

→ { :TPS#<in/out>@<S><l/O>=<mod>;<eth> }

← (TPS#<in/out>@<S/A><l/O>W=<mod>;<eth>;<cmode>;<pwr>;<upl>;<qual>;<err>;<len>;<rid>;<tmp>)CrLf

###### Example

→ { :tps#1@so=L;x }

← (TPS#1@SO=L;1;H;0;0;17161617;23222020;0;0384;38;)CrLf

The TPS mode of the selected port is set to Longreach, the Ethernet setting was not changed. The response shows the new values. Use the 'x' character to keep the actual value of a parameter.

#### Parameters

Identifier	Parameter Description	Parameter Values
Read/write Parameters		
<in>/<out>	Input or output port number	Port number in 1- or 2-digit ASCII format (01, 3, 04, etc.)
<l/O>	Input or output port type	<b>I</b> = input <b>O</b> = output
<mod>	Mode of the selected TPS port	<b>H</b> = HDBaseT <b>L</b> = Longreach <b>A</b> = Automatic <b>1</b> = Low power 1, RS-232 only <b>2</b> = Low power 2, RS-232 + Ethernet
<eth>	Ethernet status of the selected port	<b>0</b> = Ethernet is disabled <b>1</b> = Ethernet is enabled (default) <b>2-15</b> = reserved for future use
<tmp>	Temperature [integer]	Measured temperature of the board in Celsius.
Read-only Parameters		
<cmode>	The current mode of the selected TPS port	<b>E</b> : Ethernet fallback <b>1</b> : Low power 1, RS-232 only <b>2</b> : Low power 2, RS-232+ETH <b>L</b> : Longreach <b>H</b> : HDBaseT <b>0</b> (zero): Link is not present - (hyphen): The chip is under external process (e.g. during boot, fw upgrade)
<pwr>	Remote power source presence (all ports carry the same state)	<b>0</b> (zero): Not connected <b>1</b> : Connected
<upl>	Ethernet uplink status (all ports carry the same state)	<b>0</b> (zero): Ethernet is inactive <b>1</b> : Ethernet is active
<qual>	Quality of the link [HEXA number]	Measured values give information about the quality of the link
<err>	Maximum measured error [HEXA number]	Measured values give information about the quality of the cable.
<len>	The measured length of the cable (meters) – informative only Valid for CAT5e cable	Measured length of the link cable. If the cable is shorter than 20m the response is 0. If the cable is longer than 110m the response is 1000. If there is no data the response is 0, as well.
<rid>	Remote device identifier [HEXA number]	Lightware devices have a unique ID for identifying each other.
<tmp>	Temperature [integer]	Measured temperature of the board in Celsius.

### 7.9.1.2. Remote Power Settings (PoE)

Query or set the PoE-compatible remote power state of the TPS2 port. The format and the usage are the same in the case of the input and output ports.

#### Supported Boards

- *MX-TPS2-IB-P, -AP, -SP*
- *MX-4TPS2-4HDMI-IB-P, -AP, -SP*
- *MX-4TPS2-4HDMI-OB-P, -AP, -SP*
- *MX-TPS2-OB-P, -AP, -SP*

#### Querying the Parameters

##### Command and Response

→ {:POE#<in/out>@S<I/O>=?}

← (POE#<in/out>@S<I/O>=<mode>;<status>);CrLf

##### Example

→ {:poe#1@so=?}

← (POE#1@SO=0;0);CrLf

The PoE is disabled on the Output 1 (and inactive).

#### Setting the Parameters

##### Command and Response

→ {:POE#<in/out>@S<I/O>=<mode>;<status>}

← (POE#<in/out>@S<I/O>=<mode>;<status>);CrLf

##### Example

→ {:poe#1@so=1;0}

← (POE#1@SO=1;0);CrLf

The PoE is set to enabled on Output 1 but not active.

#### Parameters

Identifier	Parameter description	Parameter values
<mode>	Enable/disable the PoE feature	<b>0</b> = PoE is disabled; <b>1</b> = PoE is enabled
<status>	Remote power sending (read-only parameter)	<b>0</b> = power sending is not in progress (inactive) <b>1</b> = power sending is in progress (active)

### 7.9.2. HDMI Input Port

#### 7.9.2.1. Port Parameters and Settings

Query or set the HDMI port-related parameters (not the HDMI-3D port!).

#### Supported Boards

- *MX-HDMI-IB; MX-DVI-HDCP-IB; MX-HDMI-TP-IB; CPU-IB (Test input)*

#### Querying the Parameters

##### Command and Response

→ {:HDMI#<in>@<S/C/A>I=?}

← (HDMI#<in>@<S/C/A>I=<info>;<video>;<audio>;<adv\_info>;<in\_set>);CrLf

##### Example

→ {:HDMI#17@SI=?}

← (HDMI#17@SI=S1131;V1920x1080p60,675,00;A1C010000;I11111A;PA1);CrLf

The actual settings are in the response; see the Parameters of each block for the details.

#### Setting the Parameters

##### Command and Response

→ {:HDMI#<in>@<S/C/A>I=<a><b>}

← (HDMI#<in>@<S/C/A>I=<info>;<video>;<audio>;<adv\_info>;<in\_set>);CrLf

##### Example

→ {:HDMI#17@SI=x;0;}

← (HDMI#17@SI=S1131;V1920x1080p60,675,00;A1C010000;I11111A;PA0);CrLf

The HDCP setting is changed to 'disabled' (0). The legend of <a> and <b> parameters are described in the <in\_set> block section. Use the 'x' character to keep the actual value of a parameter. The response contains the new settings in the <in\_set> block.



**Parameters**

**<info> block**

The signal info block contains general information about the signal. The first character of this block is **S**.

**Format:** S<a><b><c><d>

Identifier	Parameter Description	Parameter Values
<a>	5V power presence	<b>0</b> = 5V is not present <b>1</b> = 5V is present
<b>	Signal detection	<b>0</b> = no valid signal on the input <b>1</b> = active video signal is present
<c>	DV/HDMI mode indicator	<b>0</b> = DVI mode <b>1</b> = HDMI mode (24 bpp) <b>2</b> = HDMI mode (30 bpp), deep color <b>3</b> = HDMI mode (36 bpp), deep color
<d>	HDCP state	<b>0</b> = HDCP encryption is disabled <b>1</b> = HDCP encryption is active

**Example:** S1131 #hdcp

5V and active video signal is present in HDMI deep color mode (36 bpp), HDCP is active.

**<video> block**

INFO: This block is present only if a valid video signal is present on the selected port.

The resolution, refresh rate, scan mode, and color space information are described in this block. The first character of this block is **V**.

**Format:** V<Resolution>,<Hsync>,<Color\_space>

**Example:** V1920x1080p60,675,00

Identifier	Parameter Description	Parameter Values
<Resolution>	<Width>x<Height><Scan><Vsync>	<Width> = active video width (pixels) <Height> = active video height (pixels) <Scan> = <b>p</b> : progressive, <b>i</b> : interlaced scan mode <Vsync> value (Hz)
<Hsync>	Horizontal sync	<Hsync> value (kHz)
<Color_space>	Color space information	<b>00</b> = RGB444 <b>10</b> = YUV422 <b>20</b> = YUV444

1080p60 signal is detected with progressive scan at 60 Hz refresh rate; vertical sync value is 675 kHz and the signal is in RGB 4:4:4 color space.

**<audio> block** #audio

INFO: This block is present only if a valid video signal is present on the selected port.

The audio info block determines the type of the audio, the decoded sampling frequency and some further information extracted from Audio InfoFrames. The first character of this block is **A**.

**Format:** A<a><b><c><d><ee><ff>

Identifier	Parameter Description	Parameter Values			
<a>	Audio type	<b>0</b> = no audio data is present <b>1</b> = PCM audio <b>2</b> = Compressed audio <b>4</b> = High bitrate audio			
<b>	Sampling frequency	<b>A</b> = 44.1 kHz <b>C</b> = 48 kHz <b>D</b> = 32 kHz <b>E</b> = 22.05 kHz <b>G</b> = 24 kHz <b>I</b> = 88.2 kHz <b>J</b> = 768 kHz <b>K</b> = 96 kHz <b>M</b> = 176.4 kHz <b>O</b> = 192 kHz <b>B</b> = no information			
<c>	Audio codec type (not specified in many cases)	<b>0</b> = undetermined <b>1</b> = IEC 60958PCM <b>2</b> = AC3 <b>3</b> = MPEG-1 (Layers 1&2) <b>4</b> = MP3 (MPEG-1 Layer 3) <b>5</b> = MPEG-2 (multichannel) <b>6</b> = AAC <b>7</b> = DTS <b>8</b> = ATRAC <b>9</b> = One Bit Audio <b>A</b> = Dolby Digital <b>B</b> = DTS-HD <b>C</b> = MLP			
<d>	Audio channel number	<b>0</b> = not specified <b>0..7</b> = channel number is equal to (<d>+1)			
<ee>	Sampling frequency and sample size (encoded in HEX format and represented by binary format)	<table border="0"> <tr> <td>7-5 bits: reserved and shall be 0 (zero)</td> <td>4-2 bits: <b>000</b> = unspecified <b>001</b> = 32 kHz <b>010</b> = 44.1 kHz <b>011</b> = 48 kHz <b>100</b> = 88.2 kHz <b>101</b> = 96 kHz <b>110</b> = 176.4 kHz <b>111</b> = 192 kHz</td> <td>1-0 bits: <b>00</b> = not specified <b>01</b> = 16 bit <b>10</b> = 20 bit <b>11</b> = 24 bit</td> </tr> </table> <p>example: <b>0F</b> = 000 011 11 48 kHz sampling frequency and 24 bit sample length</p>	7-5 bits: reserved and shall be 0 (zero)	4-2 bits: <b>000</b> = unspecified <b>001</b> = 32 kHz <b>010</b> = 44.1 kHz <b>011</b> = 48 kHz <b>100</b> = 88.2 kHz <b>101</b> = 96 kHz <b>110</b> = 176.4 kHz <b>111</b> = 192 kHz	1-0 bits: <b>00</b> = not specified <b>01</b> = 16 bit <b>10</b> = 20 bit <b>11</b> = 24 bit
7-5 bits: reserved and shall be 0 (zero)	4-2 bits: <b>000</b> = unspecified <b>001</b> = 32 kHz <b>010</b> = 44.1 kHz <b>011</b> = 48 kHz <b>100</b> = 88.2 kHz <b>101</b> = 96 kHz <b>110</b> = 176.4 kHz <b>111</b> = 192 kHz	1-0 bits: <b>00</b> = not specified <b>01</b> = 16 bit <b>10</b> = 20 bit <b>11</b> = 24 bit			
<ff>	Speaker locations (See the following table for the possible values)	This byte describes how various speaker locations are allocated to the audio channels: <b>FR/FL</b> = Front Right / Front Left <b>LFE</b> = Low-frequency effect <b>FC/RC</b> = Front Center / Rear Center <b>RR/RL</b> = Rear Right / Rear Left <b>FRC/FLC</b> = Front Right Center / Front Left Center <b>RRC/RLC</b> = Rear Right Center / Rear Left Center			

**Example:** A1C010000

PCM audio is present at 48 kHz. The codec is not specified, two audio channels are defined.

INFO: Please note that the values of <c>, <d>, <ee> and <ff> parameters are based on the audio info frame sent by the source device while values of <a> and <b> are based on measurements. Audio info frames are forwarded in unchanged format to the HDMI sink devices (e.g. A/V Receivers) so that they would be able to interpret the InfoFrames correctly.

<ff> value	Speaker locations							
	Channel Number							
	8	7	6	5	4	3	2	1
00							FR	FL
01						LFE	FR	FL
02					FC		FR	FL
03					FC	LFE	FR	FL
04				RC			FR	FL
05				RC		LFE	FR	FL
06				RC	FC		FR	FL
07				RC	FC	LFE	FR	FL
08			RR	RL			FR	FL
09			RR	RL		LFE	FR	FL
0A			RR	RL	FC		FR	FL
0B			RR	RL	FC	LFE	FR	FL
0C		RC	RR	RL			FR	FL
0D		RC	RR	RL		LFE	FR	FL
0E		RC	RR	RL	FC		FR	FL
0F		RC	RR	RL	FC	LFE	FR	FL
10	RRC	RLC	RR	RL			FR	FL
11	RRC	RLC	RR	RL		LFE	FR	FL
12	RRC	RLC	RR	RL	FC		FR	FL
13	RRC	RLC	RR	RL	FC	LFE	FR	FL
14	FRC	FLC					FR	FL
15	FRC	FLC				LFE	FR	FL
16	FRC	FLC			FC		FR	FL
17	FRC	FLC			FC	LFE	FR	FL
18	FRC	FLC		RC			FR	FL
19	FRC	FLC		RC		LFE	FR	FL
1A	FRC	FLC		RC	FC		FR	FL
1B	FRC	FLC		RC	FC	LFE	FR	FL
1C	FRC	FLC	RR	RL			FR	FL
1D	FRC	FLC	RR	RL		LFE	FR	FL
1E	FRC	FLC	RR	RL	FC		FR	FL
1F	FRC	FLC	RR	RL	FC	LFE	FR	FL

**<adv\_info> block**

For advanced users this block provides information which could be useful during debugging process. The first character of this block is I.

**Format:** I<a><b><c><d><ee><ff>

Identifier	Parameter Description	Parameter Values
<a>	VSYNC polarity	<b>0</b> = VSYNC polarity is negative (leading edge falls) <b>1</b> = VSYNC polarity is positive (leading edge rises)
<b>	HSYNC polarity	<b>0</b> = HSYNC polarity is negative (leading edge falls) <b>1</b> = HSYNC polarity is positive (leading edge rises)
<c>	TMDS clock line signal presence	<b>0</b> = There is no change on the TMDS clock line <b>1</b> = Signal is present on the TMDS clock line
<d>	TMDS clock line stability	<b>0</b> = The clock signal is unstable on the TMDS clock line <b>1</b> = The clock signal is stable on the TMDS clock line
<e>	Active Format Aspect Ratio based on AVI InfoFrame	<b>0</b> = Field is not present (e.g. DVI signal) <b>2</b> = 16:9 (top) <b>3</b> = 14:9 (top) <b>4</b> = greater than 16:9 (center) <b>5</b> = Same as picture aspect ratio <b>9</b> = 4:3 (center) <b>A</b> = 16:9 (center) <b>B</b> = 14:9 (center) <b>D</b> = 4:3 (with shoot and protect 14:9 center) <b>E</b> = 16:9 (with shoot and protect 14:9 center) <b>F</b> = 16:9 (with shoot and protect 4:3 center)
<f>	Pixel repetition factor based on AVI InfoFrame	<b>0</b> = No repetition (i.e. pixel sent once) <b>1</b> = Pixel sent 2 times (i.e. repeated once) <b>3</b> = Pixel sent 4 times

**Example:** I111190.

Positive HSYNC and VSYNC, stable pixel clock, 4:3 aspect ratio and no pixel repetition).

**<in\_set> block**

You can verify the actual settings as this block is always present. The first character is P.

**Format:** P<a><b>

Identifier	Parameter Description	Parameter Values
<a>	State of color range compression	<b>A</b> = no change; <b>C</b> = compress; <b>E</b> = expand
<b>	HDCP status	<b>0</b> = HDCP is disabled; <b>1</b> = HDCP is enabled

**Example:** PA1

The color range setting is 'no change' and HDCP is enabled.

### 7.9.2.2. Timing Parameters

The system continuously measures the parameters of the incoming signals. The answer consists of 16 data bytes and every data byte is represented as a two-digit hexadecimal number. The parameters could be useful for advanced debugging processes.

#### Supported Boards

- MX-HDMI-IB; MX-DVI-HDCP-IB; MX-HDMI-TP-IB; CPU-IB (Test input)

#### Command and Response

```
→{:TIMINGS#<in>@<S/C/A>I=?}
←(TIMINGS#<in>@<S/C/A>I=<Timing_codes>)CrLf
```

#### Example

```
→{:TIMINGS#17@SI=?}
←(TIMINGS#17@SI=0360027102D002402C0501004008630C)CrLf
```

For more information about the measured values, please contact Lightware Support.

### 7.9.3. HDMI-3D Input Port

#### 7.9.3.1. Port Parameters and Settings

Query or set the HDMI-3D input port related parameters.

#### Supported Boards

- MX-HDMI-3D-IB, -A, -S; MX-DVI-4K-IB
- MX-4TPS2-4HDMI-IB, -A, -S; MX-4TPS2-4HDMI-IB-P, -AP, -SP
- MX-TPS-IB, -A, -S; MX-TPS2-IB-P, -AP, -SP

#### Query the Parameters

##### Command and Response

```
→{:HDMI#<in>@<S/C/A>I=?}
←(HDMI#<in>@<S/C/A>I=<info>;<video>;<audio>;<adv_info>;<ext_info>;<in_set>;)CrLf
```

#### Example

```
→{:HDMI#17@SI=?}
←(HDMI#17@SI=S1110;V720x576p50,313,00;A1C110f00;I0011AA;E1400;PX1007B;)CrLf
```

The actual settings are in the response; see the legend of each block for the details.

### Setting the Parameters

#### Command and Response

```
→{:HDMI#<in>@<S/C/A>I=X;<HDCP_mode>;<TPG_mode>;<TPG_clock>;<TPG_screen>;<Audio_mode>}
←(HDMI#<in>@<S/C/A>I=<info>;<video>;<audio>;<adv_info>;<ext_info>;<in_set>;)CrLf
```

#### Example

```
→{:hdmi#1@si=X;;;A}
←(HDMI#1@SI=S1110;V720x576p50,313,00;A1C110f00;I0011AA;E1400;PX1007A;)CrLf
```

The first character is always 'X' when setting the parameters. The Audio mode is set to mode 'C' but the other parameters have not been changed. Use the space character to keep the actual value of a parameter. The parameters of the sent command is described in the <in\_set> block; see the Parameters below.

#### Parameters

##### <INFO> block

The signal info block contains general information about the signal. The first character of this block is **S**.

**Format:** S<a><b><c><d>

Identifier	Parameter Description	Parameter Values
<a>	5V power presence	<b>0</b> = 5V is not present <b>1</b> = 5V is present
<b>	Signal detection	<b>0</b> = no valid signal on the input <b>1</b> = active video signal is present
<c>	DV/HDMI mode indicator	<b>0</b> = DVI mode <b>1</b> = HDMI mode (24 bpp) <b>2</b> = HDMI mode (30 bpp), deep color <b>3</b> = HDMI mode (36 bpp), deep color
<d>	HDCP state	<b>0</b> = HDCP encryption is disabled <b>1</b> = HDCP encryption is enabled

**Example:** S1131 #hdcp

5V and active video signal is present in HDMI deep color mode (36 bpp), HDCP is active.

**<video> block**

INFO: This block is present only if valid video signal is present on the selected port.

The resolution, refresh rate, scan mode, and color space information are described in this block. The first character of this block is V.

**Format:** V<Resolution>,<Hsync>,<Color\_space><3D\_format>

Identifier	Parameter Description	Parameter Values	
<Resolution>	<Width>x<Height><Scan><Vsync>	<Width> = active video width (pixels) <Height> = active video height (pixels) <Scan> = <b>p</b> : progressive, <b>i</b> : interlaced scan mode <Vsync> value (Hz)	
<Hsync>	Horizontal sync	<Hsync> value (kHz)	
<Color_space>	Color space information	<b>0</b> = RGB444 <b>1</b> = YUV422 <b>2</b> = YUV444	
<3D_format>	3D format descriptor	<b>0</b> = 2D signal <b>1</b> = frame packing <b>2</b> = top-bottom <b>3</b> = side-by-side (half) <b>4</b> = Field alternative	<b>5</b> = Line alternative <b>6</b> = Side by side (full) <b>7</b> = L+depth <b>8</b> = L + depth + graphics

**Example:** V720x576p50,313,00

720x576 signal resolution is detected with progressive scan at 50 Hz refresh rate; vertical sync value is 313 kHz and the signal is in 2D format with RGB 4:4:4 color space.

**<audio> block** #audio

INFO: This block is present only if a valid video signal is present on the selected port.

The audio info block determines the type of the audio, the decoded sampling frequency and some further information extracted from Audio InfoFrames. The first character of this block is A.

**Format:** A<a><b><c><d><ee><ff>

Identifier	Parameter Description	Parameter Values		
<a>	Audio type	<b>0</b> = no audio data is present <b>1</b> = PCM audio		<b>2</b> = Compressed audio <b>4</b> = High bitrate audio
<b>	Sampling frequency	<b>A</b> = 44.1 kHz <b>C</b> = 48 kHz <b>D</b> = 32 kHz <b>E</b> = 22.05 kHz <b>G</b> = 24 kHz <b>I</b> = 88.2 kHz		<b>J</b> = 768 kHz <b>K</b> = 96 kHz <b>M</b> = 176.4 kHz <b>O</b> = 192 kHz <b>B</b> = no information
<c>	Audio codec type (not specified in many cases)	<b>0</b> = undetermined <b>1</b> = IEC 60958PCM <b>2</b> = AC3 <b>3</b> = MPEG-1 (Layers 1&2) <b>4</b> = MP3 (MPEG-1 Layer 3) <b>5</b> = MPEG-2 (multichannel) <b>6</b> = AAC		<b>7</b> = DTS <b>8</b> = ATRAC <b>9</b> = One Bit Audio <b>A</b> = Dolby Digital <b>B</b> = DTS-HD <b>C</b> = MLP
<d>	Audio channel number	<b>0</b> = not specified <b>1..7</b> = channel number is equal to (<d>+1)		
<ee>	Sampling frequency and sample size (encoded in HEX format and represented by binary format)	7-5 bits: reserved and shall be 0 (zero)	4-2 bits: <b>000</b> = unspecified <b>001</b> = 32 kHz <b>010</b> = 44.1 kHz <b>011</b> = 48 kHz <b>100</b> = 88.2 kHz <b>101</b> = 96 kHz <b>110</b> = 176.4 kHz <b>111</b> = 192 kHz	1-0 bits: <b>00</b> = not specified <b>01</b> = 16 bit <b>10</b> = 20 bit <b>11</b> = 24 bit
<ff>	Speaker locations (See the following table for the possible values)	This byte describes how various speaker locations are allocated to the audio channels: <b>FR/FL</b> = Front Right / Front Left <b>LFE</b> = Low-frequency effect <b>FC/RC</b> = Front Center / Rear Center <b>RR/RL</b> = Rear Right / Rear Left <b>FRC/FLC</b> = Front Right Center / Front Left Center <b>RRC/RLC</b> = Rear Right Center / Rear Left Center		



**Example:** A1C010000

PCM audio is present at 48 kHz. The codec is not specified, two audio channels are defined.

INFO: Please note that the values of <c>, <d>, <ee> and <ff> parameters are based on the audio info frame sent by the source device while values of <a> and <b> are based on measurements. Audio info frames are forwarded in unchanged format to the HDMI sink devices (e.g. A/V Receivers) so that they would be able to interpret the InfoFrames correctly.

<ff> value	Speaker locations							
	Channel Number							
	8	7	6	5	4	3	2	1
00							FR	FL
01						LFE	FR	FL
02					FC		FR	FL
03					FC	LFE	FR	FL
04				RC			FR	FL
05				RC		LFE	FR	FL
06				RC	FC		FR	FL
07				RC	FC	LFE	FR	FL
08			RR	RL			FR	FL
09			RR	RL		LFE	FR	FL
0A			RR	RL	FC		FR	FL
0B			RR	RL	FC	LFE	FR	FL
0C		RC	RR	RL			FR	FL
0D		RC	RR	RL		LFE	FR	FL
0E		RC	RR	RL	FC		FR	FL
0F		RC	RR	RL	FC	LFE	FR	FL
10	RRC	RLC	RR	RL			FR	FL
11	RRC	RLC	RR	RL		LFE	FR	FL
12	RRC	RLC	RR	RL	FC		FR	FL
13	RRC	RLC	RR	RL	FC	LFE	FR	FL
14	FRC	FLC					FR	FL
15	FRC	FLC				LFE	FR	FL
16	FRC	FLC			FC		FR	FL
17	FRC	FLC			FC	LFE	FR	FL
18	FRC	FLC		RC			FR	FL
19	FRC	FLC		RC		LFE	FR	FL
1A	FRC	FLC		RC	FC		FR	FL
1B	FRC	FLC		RC	FC	LFE	FR	FL
1C	FRC	FLC	RR	RL			FR	FL
1D	FRC	FLC	RR	RL		LFE	FR	FL
1E	FRC	FLC	RR	RL	FC		FR	FL
1F	FRC	FLC	RR	RL	FC	LFE	FR	FL

**<adv\_info> block**

INFO: This block is present only if a valid video signal is present on the selected port.

For advanced users this block provides information which could be useful during debugging process. The first character of this block is I.

**Format:** I<a><b><c><d><ee><ff>

Identifier	Parameter Description	Parameter Values
<a>	VSYNC polarity	0 = VSYNC polarity is negative (leading edge falls) 1 = VSYNC polarity is positive (leading edge rises)
<b>	HSYNC polarity	0 = HSYNC polarity is negative (leading edge falls) 1 = HSYNC polarity is positive (leading edge rises)
<c>	TMDS clock line signal presence	0 = There is no change on the TMDS clock line 1 = Signal is present on the TMDS clock line
<d>	TMDS clock line stability	0 = The clock signal is unstable on the TMDS clock line 1 = The clock signal is stable on the TMDS clock line
<e>	Active Format Aspect Ratio based on AVI InfoFrame	0 = Field is not present (e.g. DVI signal) 2 = 16:9 (top) 3 = 14:9 (top) 4 = greater than 16:9 (center) 5 = Same as picture aspect ratio 9 = 4:3 (center) A = 16:9 (center) B = 14:9 (center) D = 4:3 (with shoot and protect 14:9 center) E = 16:9 (with shoot and protect 14:9 center) F = 16:9 (with shoot and protect 4:3 center)
<f>	Pixel repetition factor based on AVI InfoFrame	0 = No repetition (i.e. pixel sent once) 1 = Pixel sent 2 times (i.e. repeated once) 3 = Pixel sent 4 times

**Example:** I111190.

Positive HSYNC and VSYNC, stable pixel clock, 4:3 aspect ratio and no pixel repetition.

**<ext\_info> block**

Additional information about the 3D-capable ports is displayed in this block. The first character is E.

**Format:** E<addon><TPG\_res><TPG\_alert><FW\_mode>

Identifier	Parameter Description	Parameter Values	
<addon>	The type of the installed audio add-on board	<b>0</b> = no add-on board is installed <b>1</b> = add-on type is S/PDIF <b>2</b> = add-on type is stereo (UDA) <b>3</b> = add-on type is stereo (ADAV) <b>F</b> = add-on type is stereo but initialization is failed	
<TPG_res>	The resolution of the test pattern	<b>0</b> = Test pattern generator is inactive <b>3</b> = active, the resolution is 720x576p@50Hz <b>4</b> = active, the resolution is 720x480p@60Hz	
<TPG_alert>	Test pattern alert information	<b>0</b> = no error <b>1</b> = unsupported resolution is detected	
<FW_mode>	The forwarded signal mode from the board	<b>0</b> = DVI <b>1</b> = HDMI, 24 bit <b>2</b> = HDMI, 30 bit	<b>3</b> = HDMI, 36 bit <b>4</b> = HDMI, 48 bit

**Example:** E1400

S/PDIF add-on board is installed at the given port; the Test pattern generator is active at 720x480p60 resolution running without errors. The forwarded signal is DVI.

**<in\_set> block**

You are able to verify the actual settings on the selected input ports with this block as this block is always present. The first character is P, the second is X. *#nosyncscreen #testpattern*

**Format:** PX<HDCP\_mode><TPG\_mode><TPG\_clock><TPG\_screen><Audio\_mode>

Identifier	Parameter Description	Parameter Values	
<HDCP_mode>	HDCP mode setting	<b>0</b> = HDCP is disabled	<b>1</b> = HDCP is enabled
<TPG_mode>	The mode of the Test pattern generator	<b>0</b> = off, test pattern is not sent (default) <b>1</b> = on, test pattern is <b>always</b> sent <b>2</b> = test pattern is sent if there is no incoming signal	
<TPG_clock>	The resolution of the test pattern	<b>0</b> = 720x480p60 <b>1</b> = 720x576p50	<b>2</b> = the same as the incoming signal *
<TPG_screen>	The type of the test pattern	<b>0</b> = solid red <b>1</b> = solid green <b>2</b> = solid blue <b>3</b> = solid black <b>4</b> = solid white <b>5</b> = ramp	<b>6</b> = chessboard <b>7</b> = color bar <b>8</b> = cycle (the patterns are switched in every two seconds)
<Audio_mode>	Audio mode setting of the installed add-on board **	<b>A</b> = no audio <b>B</b> = HDMI passthrough <b>C</b> = Embed from external	<b>D</b> = Deembed to external <b>E</b> = HDMI + deembed

\* The supported resolutions in the case of the test pattern generator: 480p60, 576p50, 720p50, 720p60, 1080p50, 1080p60.

\*\* See more information about the Audio modes in the [Audio Settings](#) section.

**Example:** PX1007B

HDCP is enabled; Test pattern generator is off; the original audio of the HDMI signal is embedded (passthrough).

**7.9.3.2. Timing Parameters**

The system continuously measures the parameters of the incoming signals. The answer consists of 16 data bytes and every data byte is represented as a two-digit hexadecimal number. The parameters could be useful for advanced debugging processes.

**Supported Boards**

- *MX-HDMI-3D-IB, -A, -S*
- *MX-4TPS2-4HDMI-IB, -A, -S; MX-4TPS2-IB-P, -AP, -SP*

**Command and Response**

→ {TIMINGS#<in>@<S/C/A>I=?}

← (TIMINGS#<in>@<S/C/A>I=<Timing\_codes>)CrLf

**Example**

→ {TIMINGS#17@SI=?}

← (TIMINGS#17@SI=0360027102D002402C0501004008630C)CrLf

For more information about the measured values, please contact Lightware Support.

**7.9.4. HDMI Output Port****7.9.4.1. Port Parameters and Settings**

Query or set the HDMI output port related parameters.

**Supported Boards**

- *MX-HDMI-OB; MX-DVI-HDCP-OB; MX-HDMI-TP-OB*

**Querying the Parameters****Command and Response**

→ {HDMI#<out>@<S/C/A>O=?}

← (HDMI#<out>@<S/C/A>O=<GEN\_INFO>;<VIDEO>;<ADV\_INFO>;<OUT\_SET>;<SINK>;)CrLf

**Example**

→ {HDMI#1@SO=?}

← (HDMI#1@SO=G11101;V720x576p51,313,00;I0011AA;OAAAAA;M110111077;)CrLf

The actual settings are in the response; see the Parameters of each block for the details.

**Setting the Parameters**

**Command and Response**

→ {:(HDMI#<out>@<S/C/A>O=<a>;<b>;<c>;<d>;<e>);}  
 ← (HDMI#<out>@<S/C/A>O=<GEN\_INFO>;<VIDEO>;<ADV\_INFO>;<OUT\_SET>;<SINK>);CrLf

**Example**

→ {:(HDMI#1@SO=?)}  
 ← (HDMI#1@SO=G11101;V720x576p51,313,00;I0011AA;OAAAAA;M110111077;)CrLf

The signal type is set to DVI, the other parameters have not been changed. Use the 'x' character to keep the actual value of a parameter. The response contains the new settings in the <OUT\_SET> block; see the details in the Parameters section.

**Parameters**

**<gen\_info> block**

The signal info block contains general information about the signal. The first character of this block is G.

**Format:** G<a><b><c><d><e>

Identifier	Parameter Description	Parameter Values
<a>	Sink is connected	0 = no attached sink device 1 = sink device is present
<b>	Signal type	0 = DVI signal is transmitted 1 = HDMI signal is transmitted (no deep color) 2 = HDMI signal is transmitted (deep color, 30 bit) 3 = HDMI signal is transmitted (deep color, 36 bit)
<c>	Signal validity	0 = No valid signal is routed to the port 1 = Valid video signal is present
<d>	HDCP state	0 = HDCP encryption is disabled 1 = HDCP encryption is active
<e>	Hotplug detection	0 = Hotplug detect signal is low 1 = Hotplug detect signal is high

**Example:** G11101 #hdcp

Sink device is attached to the port and HDMI signal is routed to the port. HDCP is disabled and hotplug is detected.

**<video> block**

INFO: This block is present only if a valid video signal is present on the selected port.

The resolution, refresh rate, scan mode, and color space information are described in this block. The first character of this block is V.

**Format:** V<Resolution>;<Hsync>;<Color\_space>

Identifier	Parameter Description	Parameter Values
<Resolution>	<Width>x<Height><Scan><Vsync>	<Width> = active video width (pixels) <Height> = active video height (pixels) <Scan> = <b>p</b> : progressive, <b>i</b> : interlaced scan mode <Vsync> value (Hz)
<Hsync>	Horizontal sync	<Hsync> value (kHz)
<Color_space>	Color space information	<b>00</b> = RGB444 <b>20</b> = YUV444 <b>10</b> = YUV422

**Example:** V1920x1080p60,675,00

1080p60 signal is detected with progressive scan at 60 Hz refresh rate; vertical sync value is 675 kHz and the signal is in RGB 4:4:4 color space.

**<adv\_info> block**

For advanced users this block provides information which could be useful during debugging process. The first character of this block is I.

**Format:** I<a><b><c><d><e><f>

Identifier	Parameter Description	Parameter Values
<a>	VSYNC polarity	0 = VSYNC polarity is negative (leading edge falls) 1 = VSYNC polarity is positive (leading edge rises)
<b>	HSYNC polarity	0 = HSYNC polarity is negative (leading edge falls) 1 = HSYNC polarity is positive (leading edge rises)
<c>	TMDS clock line signal presence	0 = There is no change on the TMDS clock line 1 = Signal is present on the TMDS clock line
<d>	TMDS clock line stability	0 = The clock signal is unstable on the TMDS clock line 1 = The clock signal is stable on the TMDS clock line
<e>	Active Format Aspect Ratio based on AVI InfoFrame	0 = Field is not present (e.g. DVI signal) 2 = 16:9 (top) 3 = 14:9 (top) 4 = greater than 16:9 (center) 5 = Same as picture aspect ratio 9 = 4:3 (center) A = 16:9 (center) B = 14:9 (center) D = 4:3 (with shoot and protect 14:9 center) E = 16:9 (with shoot and protect 14:9 center) F = 16:9 (with shoot and protect 4:3 center)
<f>	Pixel repetition factor based on AVI InfoFrame	0 = No repetition (i.e. pixel sent once) 1 = Pixel sent 2 times (i.e. repeated once) 3 = Pixel sent 4 times

**Example:** I111190.

Positive HSYNC and VSYNC, stable pixel clock, 4:3 aspect ratio and no pixel repetition.

**<out\_set> block**

The output settings block contains information about the actual settings of the selected port. The first character of this block is O.

**Format:** O<a><b><c><d><e>

Identifier	Parameter Description	Parameter Values
<a>	Signal type	<b>A</b> = the HDMI/DVI mode selection is automatic <b>D</b> = DVI signal is transmitted <b>H</b> = HDMI signal is transmitted (no deep color) <b>1</b> = HDMI signal is transmitted (deep color, 30 bit) <b>2</b> = HDMI signal is transmitted (deep color, 36 bit)
<b>	Color space	<b>A</b> = automatic color space selection <b>1</b> = force RGB <b>2</b> = force YUV 444 <b>3</b> = force YUV 422
<c>	Color range conversion	<b>A</b> = handle the color range conversion automatically <b>C</b> = compress the color range <b>E</b> = expand the color range to full scale
<d>	PCM subsampling	<b>A</b> = automatic PCM subsampling <b>D</b> = disable PCM subsampling <b>2</b> = 2x PCM subsampling (only at 2ch PCM signals) <b>4</b> = 4x PCM subsampling (only at 2ch PCM signals)
<e>	HDCP setting	<b>A</b> = handle the HDCP setting automatically <b>1</b> = always use HDCP

**Example:** OAAAAA #hdc

All settings are set to Automatic.

**<sink> block**

**INFO:** This block is present only if a sink device is connected to the selected port.

This block provides some general information about the attached sink device based on the EDID and the HDCP cypher engine. The first character of this block is M.

**Format:** M<a><b><c><d><e><f><gg><h>

Identifier	Parameter Description	Parameter Values
<a>	HDMI support	<b>0</b> = the sink does not support HDMI <b>1</b> = the sink is HDMI-compliant
<b>	HDCP authentication	<b>0</b> = HDCP authentication is failed <b>1</b> = HDCP authentication is successful
<c>	HDCP repeater	<b>0</b> = the sink is not an HDCP-repeater device <b>1</b> = the sink is an HDCP-repeater device
<d>	YUV 444 support	<b>0</b> = YUV 444 color space is not supported <b>1</b> = YUV 444 color space is supported
<e>	YUV 422 support	<b>0</b> = YUV 422 color space is not supported <b>1</b> = YUV 422 color space is supported
<f>	Audio support	<b>0</b> = the sink device has no audio capabilities <b>1</b> = the sink device has audio capabilities
<gg>	Audio support (binary data in HEX format)	data bit <b>0</b> = 32 kHz PCM data bit <b>1</b> = 44 kHz PCM data bit <b>2</b> = 48 kHz PCM data bit <b>3</b> = 88 kHz PCM data bit <b>4</b> = 96 kHz PCM data bit <b>5</b> = 176 kHz PCM data bit <b>6</b> = 192 kHz PCM data bit <b>7</b> = reserved (0)
<h>	Deep color support (binary data in HEX format)	data bit <b>0</b> = YUV 444 color space is supported with DC data bit <b>1</b> = HDMI with 36 bit DC is supported data bit <b>2</b> = HDMI with 30 bit DC is supported

**Example:** M110111077

The attached sink is HDMI-compatible, the HDCP authentication is successful and it is not an HDCP-repeater. The sink supports YUV 444, YUV 422 and has audio capabilities by supporting 32 kHz, 44 kHz, and 48 kHz PCM audio; deep color is supported.



### 7.9.4.2. Timing Parameters

The system continuously measures the parameters of the signals. The answer consists of 16 data bytes and every data byte is represented as a two-digit hexadecimal number. The parameters could be useful for advanced debugging processes.

#### Supported Boards

- MX-HDMI-OB; MX-DVI-HDCP-OB; MX-HDMI-TP-OB; CPU-OB (Preview output)

#### Querying the Parameters

```
→ {:TIMINGS#<in>@<S/C/A>I=?}
← (TIMINGS#<in>@<S/C/A>I=<Timing_codes>)CrLf
```

#### Example

```
→ {:TIMINGS#17@SO=?}
← (TIMINGS#17@SI=0360027102D002402C0501004008630C)CrLf
```

For more information about the measured values, please contact Lightware Support.

## 7.9.5. HDMI-3D Output Port

### 7.9.5.1. Port Parameters and Settings

Query or set the HDMI-3D output port related parameters.

#### Supported Boards

- MX-HDMI-3D-OB, -A, -S; MX-DVI-4K-OB
- MX-TPS-OB, -A, -S; MX-TPS2-OB-P, -AP, -SP; MX-4TPS2-4HDMI-OB, -A, -S, -P, -AP, -SP

#### Querying the Parameters

##### Command and Response

```
→ {:HDMI#<out>@<S/C/A>O=?}
← (HDMI#<out>@<S/C/A>O=<gen_info>;<video>;<audio>;<adv_info>;<ext_info>;<out_set>;<sink>;)CrLf
```

#### Example

```
→ {:HDMI#1@SO=?}
← (HDMI#1@SO=G111101;V1280x720p60,450,00;A1C010000;I1111IA;EF001;OHXXXA007B1;
M000000000;)CrLf
```

The actual settings are in the response; see the Parameters for the details.

### Setting the Parameters

#### Command and Response

```
→ {:HDMI#<out>@<S/C/A>O=<sig_type>;x;x;x;<HDCP_mode>;<TPG_mode>;<TPG_clk>;<TPG_screen>;
<A_mode>;<PWR_5V>}
← (HDMI#<out>@<S/C/A>O=<gen_info>;<video>;<audio>;<adv_info>;<ext_info>;<out_set>;<sink>;)CrLf
```

#### Example

```
→ {:hdmi#1@so=D;X;X;X;x;x;x;x;x;x}
(HDMI#1@SO=G111101;V1280x720p60,450,00;A1C010000;I1111IA;E0001;ODXXXA008AA;
M110111070;)CrLf
```

The signal type is set to DVI, the other parameters have not been changed. The second, third, and fourth parameters are 'x' in all cases (because of compatibility reasons). Use the 'x' character to keep the actual value of a parameter. The response contains the new settings in the <OUT\_SET> block; see the details in the Parameters section.

### Parameters

#### <GEN\_INFO> block

This block contains general information about the signal. The first character of this block is G.

**Format:** G<a><b><c><d><e>

Identifier	Parameter Description	Parameter Values
<a>	Sink is connected	0 = no attached sink device 1 = sink device is present
<b>	Signal type	0 = DVI signal is transmitted 1 = HDMI signal is transmitted (no deep color) 2 = HDMI signal is transmitted (deep color, 30 bit) 3 = HDMI signal is transmitted (deep color, 36 bit)
<c>	Signal validity	0 = No valid signal is routed to the port 1 = Valid video signal is present
<d>	HDCP state	0 = HDCP encryption is disabled 1 = HDCP encryption is active
<e>	Hotplug detection	0 = Hotplug detect signal is low 1 = Hotplug detect signal is high

**Example:** G111101 #hdcp

Sink device is attached and HDMI signal is routed to the port. HDCP is disabled and hotplug is detected.

**<video> block**

INFO: This block is present only if valid video signal is present on the given port.

The resolution, refresh rate, scan mode, color space and 3D information are described; starting with **V**.

**Format:** V<Resolution>,<Hsync>,<Color\_space><3D\_format>

Identifier	Parameter Description	Parameter Values	
<Resolution>	<Width>x<Height><scan><Vsync>	<Width> = active video width (pixels) <Height> = active video height (pixels) <scan> = <b>p</b> : progressive, <b>i</b> : interlaced scan mode <Vsync> value (Hz)	
<Hsync>	Horizontal sync	<Hsync> value (kHz)	
<Color_space>	Color space information	<b>0</b> = RGB444 <b>1</b> = YUV422	<b>2</b> = YUV444
<3D_format>	3D format descriptor	<b>0</b> = 2D signal <b>1</b> = frame packing <b>2</b> = top-bottom <b>3</b> = side-by-side (half) <b>4</b> = Field alternative	<b>5</b> = Line alternative <b>6</b> = Side by side (full) <b>7</b> = L+depth <b>8</b> = L + depth + graphics

**Example:** V1280x720p60,450,00

The signal resolution is 1280x720 by progressive scan at 60 Hz vertical refresh rate, RGB 4:4:4, color space. The frequency of the horizontal sync is 450 kHz and the signal is in 2D format.

**<audio> block** *#audio*

INFO: This block is present only if a valid video signal is present on the selected port.

The audio info block determines the type of the audio, the decoded sampling frequency and some further information extracted from Audio InfoFrames. The first character of this block is **A**.

**Format:** A<a><b><c><d><ee><ff>

Identifier	Parameter Description	Parameter Values		
<a>	Audio type	<b>0</b> = no audio data is present <b>1</b> = PCM audio	<b>2</b> = Compressed audio <b>4</b> = High bitrate audio	
<b>	Sampling frequency	<b>A</b> = 44.1 kHz <b>C</b> = 48 kHz <b>D</b> = 32 kHz <b>E</b> = 22.05 kHz <b>G</b> = 24 kHz <b>I</b> = 88.2 kHz	<b>J</b> = 768 kHz <b>K</b> = 96 kHz <b>M</b> = 176.4 kHz <b>O</b> = 192 kHz <b>B</b> = no information	
<c>	Audio codec type (not specified in many cases)	<b>0</b> = undetermined <b>1</b> = IEC 60958PCM <b>2</b> = AC3 <b>3</b> = MPEG-1 (Layers 1&2) <b>4</b> = MP3 (MPEG-1 Layer 3) <b>5</b> = MPEG-2 (multichannel) <b>6</b> = AAC	<b>7</b> = DTS <b>8</b> = ATRAC <b>9</b> = One Bit Audio <b>A</b> = Dolby Digital <b>B</b> = DTS-HD <b>C</b> = MLP	
<d>	Audio channel number	<b>0</b> = not specified <b>1..7</b> = channel number is equal to (<d>+1)		
<ee>	Sampling frequency and sample size (encoded in HEX format and represented by binary format)	7-5 bits: reserved and shall be 0 (zero)	4-2 bits: <b>000</b> = unspecified <b>001</b> = 32 kHz <b>010</b> = 44.1 kHz <b>011</b> = 48 kHz <b>100</b> = 88.2 kHz <b>101</b> = 96 kHz <b>110</b> = 176.4 kHz <b>111</b> = 192 kHz	1-0 bits: <b>00</b> = not specified <b>01</b> = 16 bit <b>10</b> = 20 bit <b>11</b> = 24 bit
<ff>	Speaker locations (See the following table for the possible values)	This byte describes how various speaker locations are allocated to the audio channels: <b>FR/FL</b> = Front Right / Front Left <b>LFE</b> = Low-frequency effect <b>FC/RC</b> = Front Center / Rear Center <b>RR/RL</b> = Rear Right / Rear Left <b>FRC/FLC</b> = Front Right Center / Front Left Center <b>RRC/RLC</b> = Rear Right Center / Rear Left Center		

**Example:** A1C010000

PCM audio is present at 48 kHz. The codec is not specified, two audio channels are defined.

INFO: Please note that the values of <c>, <d>, <ee> and <ff> parameters are based on the audio info frame sent by the source device while values of <a> and <b> are based on measurements. Audio info frames are forwarded in unchanged format to the HDMI sink devices (e.g. A/V Receivers) so that they would be able to interpret the InfoFrames correctly.

<ff> value	Speaker locations							
	Channel Number							
	8	7	6	5	4	3	2	1
00							FR	FL
01						LFE	FR	FL
02					FC		FR	FL
03					FC	LFE	FR	FL
04				RC			FR	FL
05				RC		LFE	FR	FL
06				RC	FC		FR	FL
07				RC	FC	LFE	FR	FL
08			RR	RL			FR	FL
09			RR	RL		LFE	FR	FL
0A			RR	RL	FC		FR	FL
0B			RR	RL	FC	LFE	FR	FL
0C		RC	RR	RL			FR	FL
0D		RC	RR	RL		LFE	FR	FL
0E		RC	RR	RL	FC		FR	FL
0F		RC	RR	RL	FC	LFE	FR	FL
10	RRC	RLC	RR	RL			FR	FL
11	RRC	RLC	RR	RL		LFE	FR	FL
12	RRC	RLC	RR	RL	FC		FR	FL
13	RRC	RLC	RR	RL	FC	LFE	FR	FL
14	FRC	FLC					FR	FL
15	FRC	FLC				LFE	FR	FL
16	FRC	FLC			FC		FR	FL
17	FRC	FLC			FC	LFE	FR	FL
18	FRC	FLC		RC			FR	FL
19	FRC	FLC		RC		LFE	FR	FL
1A	FRC	FLC		RC	FC		FR	FL
1B	FRC	FLC		RC	FC	LFE	FR	FL
1C	FRC	FLC	RR	RL			FR	FL
1D	FRC	FLC	RR	RL		LFE	FR	FL
1E	FRC	FLC	RR	RL	FC		FR	FL
1F	FRC	FLC	RR	RL	FC	LFE	FR	FL

**<adv\_info> block**

INFO: This block is present only if a valid video signal is present on the selected port.

For advanced users this block provides information which could be useful during debugging process. The first character of this block is I.

**Format:** I<a><b><c><d><ee><ff>

Identifier	Parameter Description	Parameter Values
<a>	VSYNC polarity	0 = VSYNC polarity is negative (leading edge falls) 1 = VSYNC polarity is positive (leading edge rises)
<b>	HSYNC polarity	0 = HSYNC polarity is negative (leading edge falls) 1 = HSYNC polarity is positive (leading edge rises)
<c>	TMDS clock line signal presence	0 = There is no change on the TMDS clock line 1 = Signal is present on the TMDS clock line
<d>	TMDS clock line stability	0 = The clock signal is unstable on the TMDS clock line 1 = The clock signal is stable on the TMDS clock line
<e>	Active Format Aspect Ratio based on AVI InfoFrame	0 = Field is not present (e.g. DVI signal) 2 = 16:9 (top) 3 = 14:9 (top) 4 = greater than 16:9 (center) 5 = Same as picture aspect ratio 9 = 4:3 (center) A = 16:9 (center) B = 14:9 (center) D = 4:3 (with shoot and protect 14:9 center) E = 16:9 (with shoot and protect 14:9 center) F = 16:9 (with shoot and protect 4:3 center)
<f>	Pixel repetition factor based on AVI InfoFrame	0 = No repetition (i.e. pixel sent once) 1 = Pixel sent 2 times (i.e. repeated once) 3 = Pixel sent 4 times

**Example:** I1111A0.

Positive HSYNC and VSYNC, stable pixel clock, 19:9 aspect ratio and no pixel repetition.

**<ext\_info> block**

Additional information about the 3D-capable ports is displayed in this block. The first character of this block is E.

**Format:** E<addon><TPG\_res><TPG\_alert><FW\_mode>

Identifier	Parameter Description	Parameter Values	
<addon>	The type of the installed audio add-on board	<b>0</b> = no add-on board is installed <b>1</b> = add-on type is S/PDIF <b>2</b> = add-on type is stereo (UDA) <b>3</b> = add-on type is stereo (ADAV) <b>F</b> = add-on type is stereo but initialization is failed	
<TPG_res>	The resolution of the test pattern	<b>0</b> = Test pattern generator is inactive <b>3</b> = active, the resolution is 720x576p@50Hz <b>4</b> = active, the resolution is 720x480p@60Hz	
<TPG_alert>	Test pattern alert information	<b>0</b> = no error <b>1</b> = the resolution of the test pattern is set to the same as the incoming signal but unsupported resolution is detected	
<FW_mode>	The forwarded signal mode from the board	<b>0</b> = DVI <b>1</b> = HDMI, 24 bit <b>2</b> = HDMI, 30 bit	<b>3</b> = HDMI, 36 bit <b>4</b> = HDMI, 48 bit

**Example:** E1400

S/PDIF add-on board is installed at the given port; the Test pattern generator is active at 720x480p60 resolution running without errors. The forwarded signal is DVI.

**<out\_set> block**

The output settings block contains information about the actual settings of the selected port. The first character of this block is O.

**Format:** O<a><b><c><d><e><f><g><h><i><j>

Identifier	Parameter Description	Parameter Values	
<a>	Signal type	<b>A</b> = the HDMI/DVI mode selection is automatic <b>D</b> = DVI signal is transmitted <b>H</b> = HDMI signal is transmitted	
<b>	Color space	<b>X</b> (always, because of compatibility reasons)	
<c>	Color range conversion	<b>X</b> (always, because of compatibility reasons)	
<d>	PCM subsampling	<b>X</b> (always, because of compatibility reasons)	
<e>	HDCP setting	<b>A</b> = Auto (if the incoming signal is encrypted, HDCP is enabled) <b>1</b> = always use HDCP	
<f>	Test pattern mode	<b>0</b> = off, test pattern is not sent (default) <b>1</b> = on, test pattern is always sent <b>2</b> = test pattern is sent if there is no incoming signal	
<g>	Test pattern clock	<b>0</b> = 720x480p60 <b>1</b> = 720x576p50 <b>2</b> = the resolution is the same as the incoming signal	
<h>	Test pattern screen	<b>0</b> = solid red <b>1</b> = solid green <b>2</b> = solid blue <b>3</b> = solid black <b>4</b> = solid white	<b>5</b> = ramp <b>6</b> = chessboard <b>7</b> = color bar <b>8</b> = cycle all (switched in every two seconds)
<i>	Audio mode	<b>A</b> = no audio <b>B</b> = HDMI passthrough <b>C</b> = Embed from external	<b>D</b> = Deembed to external <b>E</b> = HDMI + deembed <b>F</b> = External audio to ARC
<j>	Power 5V mode	<b>0</b> = off (Power 5V is not sent) <b>1</b> = on (Power 5V is always sent) <b>A</b> = if the incoming resolution is changed, 5V is off for a second	

**Example:** OHXXXA007B1 #hdcp #nosyncscreen #testpattern #power5v

The signal type is HDMI, HDCP setting is Auto, Test pattern generator is off. Audio mode is 'B' and Power 5V is always sent.

**<sink> block**

**INFO:** This block is present only if a sink device is connected to the selected port.

This block provides some general information about the attached sink device based on the EDID and the HDCP cypher engine. The first character of this block is M.



**Format:** M<a><b><c><d><e><f><gg><h>

Identifier	Parameter Description	Parameter Values	
<a>	HDMI support	<b>0</b> = the sink does not support HDMI <b>1</b> = the sink is HDMI-compliant	
<b>	HDCP authentication	<b>0</b> = HDCP authentication is failed <b>1</b> = HDCP authentication is successful	
<c>	HDCP repeater	<b>0</b> = the sink is not an HDCP-repeater device <b>1</b> = the sink is an HDCP-repeater device	
<d>	YUV 444 support	<b>0</b> = YUV 444 color space is not supported <b>1</b> = YUV 444 color space is supported	
<e>	YUV 422 support	<b>0</b> = YUV 422 color space is not supported <b>1</b> = YUV 422 color space is supported	
<f>	Audio support	<b>0</b> = the sink device has no audio capabilities <b>1</b> = the sink device has audio capabilities	
<gg>	Audio support (binary data in HEX format)	data bit <b>0</b> = 32 kHz PCM data bit <b>1</b> = 44 kHz PCM data bit <b>2</b> = 48 kHz PCM data bit <b>3</b> = 88 kHz PCM	data bit <b>4</b> = 96 kHz PCM data bit <b>5</b> = 176 kHz PCM data bit <b>6</b> = 192 kHz PCM data bit <b>7</b> = reserved (0)
<h>	Deep color support (binary data in HEX format)	data bit <b>0</b> = YUV 444 color space is supported with DC data bit <b>1</b> = HDMI with 36 bit DC is supported data bit <b>2</b> = HDMI with 30 bit DC is supported	

**Example:** M110111077 #hdcp

The attached sink is HDMI-compatible, the HDCP authentication is successful and it is not an HDCP-repeater. The sink supports YUV 444, YUV 422 and has audio capabilities by supporting 32 kHz, 44 kHz, and 48 kHz PCM audio; deep color is supported.

### 7.9.5.2. Timing Parameters

The system continuously measures the parameters of the signals. The answer consists of 16 data bytes and every data byte is represented as a two-digit hexadecimal number. The parameters could be useful for advanced debugging processes.

#### Supported Boards

- MX-HDMI-3D-OB, -A, -S

#### Querying the Parameters

```
→ {TIMINGS#<in>@<S/C/A>I=?}
← (TIMINGS#<in>@<S/C/A>I=<Timing_codes>)CrLf
```

#### Example

```
→ {TIMINGS#17@SO=?}
← (TIMINGS#17@SI=0360027102D002402C0501004008630C)CrLf
```

For more information about the measured values, please contact Lightware Support.

## 7.9.6. DVI-I Input Port

### 7.9.6.1. Port Parameters and Settings

Query or set the DVI-I input port related parameters. See the details in the Parameters section.

#### Supported Boards

- MX-DVII-HDCP-IB; MXD-UMX-IB

#### Querying the Parameters 1. (When Analog Signal is Present)

##### Command and Response

```
→ {DVII#<in>@<S/C/A>I=?}
← (DVII#<in>@<S/C/A>I=<src>;<sig_type>;<aud>;<hdcp>;<ps>;<video>;<timings_1>;<timings_2>;<res>;)CrLf
```

##### Example

```
→ {DVII#9@SI=?}
← (DVII#9@SI=S;A;D;1;1;R;2;0;1920x1080p59;)CrLf
```

The first six parameter types are always the same in the case of analog and digital signal.

#### Querying the Parameters 2. (When Digital Signal is Present)

##### Command and Response

```
→ {DVII#<in>@<S/C/A>I=?}
← (DVII#<in>@<S/C/A>I=<src>;<sig_type>;<aud>;<hdcp>;<ps>;<video>;<color>;<res>;<a_type>;<a_samp>;<a_ch>;)CrLf
```

##### Example

```
→ {DVII#9@SI=?}
← (DVII#9@SI=S;A;D;1;1;H;00;1920x1080p60;P;48;)CrLf
```

The first six parameter types are always the same in the case of analog and digital signal. <a\_type>, <a\_samp>, and <a\_ch> parameters exist only when the incoming signal type is HDMI.

#### Setting the Parameters

##### Command and Response

```
→ {DVII#<in>@<S/C/A>I=<src>;<sig_type>;<aud>;<hdcp>;}
← (DVII#<in>@<S/C/A>I=<src>;<sig_type>;<aud>;<hdcp>;<ps>;<video>;<color>;<res>;<a_type>;<a_samp>;<a_ch>;)CrLf
```

##### Example

```
→ {DVII#9@SI=x;D;x;0;}
← (DVII#9@SI=S;D;D;1;1;H;00;1920x1080p60;P;48;)CrLf
```

The signal type is changed to DVI and the HDCP is set to disabled. The other parameters are left unchanged. Use the 'x' character to keep the actual value of a parameter.

**Parameters (The First Six Common Parameters)**

Identifier	Parameter Description	Parameter Values								
<src>	Source type	<b>R</b> = analog RGB <b>Y</b> = analog YUV <b>A</b> = automatic analog <b>D</b> = digital interface (HDMI or YPbPr) <b>S</b> = automatic input selection								
<sig_type>	Signal type sent to the crosspoint	<b>A</b> = auto (if the port is not HDMI-compatible the type will be DVI) <b>D</b> = DVI (no audio) <b>H</b> = if HDMI signal is present the type will be HDMI. If analog or DVI signal is present the type will be DVI.								
<audio>	Audio signal presence	<b>0</b> = no audio <b>D</b> = embedded audio (from HDMI) <b>A</b> = audio from the add-on board (if exists)								
<hdcp>	HDCP setting	<b>0</b> = HDCP is disabled <b>1</b> = HDCP is enabled								
<ps>	Port status, binary data represented in HEX format (read-only)	<table border="1"> <thead> <tr> <th>bit 3</th> <th>bit 2</th> <th>bit 1</th> <th>bit 0</th> </tr> </thead> <tbody> <tr> <td>reserved</td> <td><b>0</b> = not protected <b>1</b> = HDCP-protected</td> <td><b>0</b> = 5V not detected <b>1</b> = 5V detected</td> <td></td> </tr> </tbody> </table>	bit 3	bit 2	bit 1	bit 0	reserved	<b>0</b> = not protected <b>1</b> = HDCP-protected	<b>0</b> = 5V not detected <b>1</b> = 5V detected	
bit 3	bit 2	bit 1	bit 0							
reserved	<b>0</b> = not protected <b>1</b> = HDCP-protected	<b>0</b> = 5V not detected <b>1</b> = 5V detected								
<video>	The detected signal type (read-only)	<b>H</b> = HDMI signal <b>D</b> = DVI signal <b>R</b> = RGBHV (analog signal with HV sync) <b>C</b> = component (analog signal with embedded HV sync) <b>-</b> = no video signal, no sync detected								

**Parameters of the Addition (Analog Signal) #hdcp**

Identifier	Parameter Description	Parameter Values
<timings_1> <timings_2>	Timing parameters	for more information about the measured values, please contact Lightware Support
<res>	The name of the resolution (string)	short name in the case of SMPTE standard, otherwise <width>x<height>p<refr_rate>, e.g. 1600x1200p60

**Parameters of the Addition (Digital Signal)**

Identifier	Parameter Description	Parameter Values										
<color>	Color information; binary data represented in HEX format *	<table border="1"> <thead> <tr> <th>bit 4</th> <th>bit 3</th> <th>bit 2</th> <th>bit 1</th> <th>bit 0</th> </tr> </thead> <tbody> <tr> <td>YCbCr 4:4:4</td> <td>YCbCr 4:2:2</td> <td>48 bit/pixel (not supported)</td> <td>36 bit/pixel</td> <td>30 bit/pixel (not supported)</td> </tr> </tbody> </table>	bit 4	bit 3	bit 2	bit 1	bit 0	YCbCr 4:4:4	YCbCr 4:2:2	48 bit/pixel (not supported)	36 bit/pixel	30 bit/pixel (not supported)
bit 4	bit 3	bit 2	bit 1	bit 0								
YCbCr 4:4:4	YCbCr 4:2:2	48 bit/pixel (not supported)	36 bit/pixel	30 bit/pixel (not supported)								
<res>	The name of the resolution (string)	<width>x<height>p<refr_rate>, e.g. 1600x1200p60										

\* If bit 0, bit 1, and bit 2 are 0, the color depth is 24 bit/pixel. If bit 3 and bit 4 are 0, the color space is RGB. E.g. 00 = RGB color space at 24 bit/pixel color depth. #audio

Identifier	Parameter Description	Parameter Values
<a_typ>	Audio type of the embedded audio (HDMI)	<b>0</b> = no audio <b>P</b> = 2-channel L-PCM <b>M</b> = multichannel PCM <b>S</b> = compressed audio <b>H</b> = HBR audio <b>D</b> = DST audio <b>E</b> = DSD audio
<a_samp>	Sampling frequency of the embedded audio (HDMI)	<b>32</b> = 32 kHz <b>44</b> = 44.1 kHz <b>48</b> = 48 kHz <b>88</b> = 88.2 kHz <b>96</b> = 96 kHz <b>176</b> = 176.4 kHz <b>192</b> = 192 kHz
<a_ch>	Speaker locations (only at M-PCM audio)	This byte describes the different speaker locations allocated to the audio channels. See the following table for the possible values.

<ff> value	Speaker Locations							
	Channel Number							
	8	7	6	5	4	3	2	1
00							FR	FL
01						LFE	FR	FL
02					FC		FR	FL
03					FC	LFE	FR	FL
04				RC			FR	FL
05				RC		LFE	FR	FL
06				RC	FC		FR	FL
07				RC	FC	LFE	FR	FL
08			RR	RL			FR	FL
09			RR	RL		LFE	FR	FL
0A			RR	RL	FC		FR	FL
0B			RR	RL	FC	LFE	FR	FL
0C		RC	RR	RL			FR	FL
0D		RC	RR	RL		LFE	FR	FL
0E		RC	RR	RL	FC		FR	FL
0F		RC	RR	RL	FC	LFE	FR	FL
10	RRC	RLC	RR	RL			FR	FL
11	RRC	RLC	RR	RL		LFE	FR	FL
12	RRC	RLC	RR	RL	FC		FR	FL
13	RRC	RLC	RR	RL	FC	LFE	FR	FL
14	FRC	FLC					FR	FL
15	FRC	FLC				LFE	FR	FL
16	FRC	FLC			FC		FR	FL
17	FRC	FLC			FC	LFE	FR	FL
18	FRC	FLC		RC			FR	FL
19	FRC	FLC		RC		LFE	FR	FL
1A	FRC	FLC		RC	FC		FR	FL
1B	FRC	FLC		RC	FC	LFE	FR	FL
1C	FRC	FLC	RR	RL			FR	FL
1D	FRC	FLC	RR	RL		LFE	FR	FL
1E	FRC	FLC	RR	RL	FC		FR	FL
1F	FRC	FLC	RR	RL	FC	LFE	FR	FL

### 7.9.6.2. Test Pattern Settings

Query or set the color of the test pattern (which is activated when there is no incoming signal).

#### Supported Boards

- *MX-DVII-HDCP-IB; MXD-UMX-IB*

#### Querying the Parameters

##### Command and Response

```
→ {SETBG#<in>@<S/C/A>I=?}
← (SETBG#<in>@<S/C/A>I=<rgb_color>;)CrLf
```

##### Example

```
→ {SETBG#9@SI=?}
← (SETBG#9@SI=255;0;0;)CrLf
```

The color of the test pattern is red, see the legend for the details.

#### Setting the Parameters

##### Command and Response

```
→ {SETBG#<in>@<S/C/A>I=<rgb_color>}
← (SETBG#<in>@<S/C/A>I=<rgb_color>;)CrLf
```

##### Example

```
→ {SETBG#9@SI=255;255;0;}
← (SETBG#9@SI=255;255;0;)CrLf
```

The color of the test pattern has been changed to yellow.

#### Parameters

The RGB color of the test pattern can be set by these parameters:

<rgb\_color> = Red;Green;Blue

### Timing Parameters

The system continuously measures the parameters of the signals. The answer consists of 12 parameters which could be useful for advanced debugging processes.

#### Supported Boards

- *MX-DVII-HDCP-IB; MXD-UMX-IB*

#### Querying the Parameters

##### Command and Response

```
→ {GETTIMINGS#<in>@<S/C/A>I=?}(SETBG#<in>@<S/C/A>I=<rgb_color>;)CrLf
← (GETTIMINGS#<in>@<S/C/A>I=<Timing_codes>;)CrLf
```

##### Example

```
→ {GETTIMINGS#9@SI=?}
← (GETTIMINGS#9@SI=2200;1920;89;44;147;1125;1080;4;5;36;148484;24;)CrLf
```

For more information about the measured values, please contact Lightware Support.

### 7.9.7. UMX Input Port

#### 7.9.7.1. Port Parameters and Settings

The port parameters and settings are the same as in the case of DVI-I input port, see the [DVI-I Input Port](#) section.

#### 7.9.7.2. Audio Source Selection

Query or set the audio signal routing.

#### Supported Boards

- *MXD-UMX-IB*

#### Querying the Parameters

##### Command and Response

```
→ {AUDSRC#<in>@<S/C/A>I=?}
← (AUDSRC#9@SI=<aud_mode>;)CrLf
```

##### Example

```
→ {AUDSRC#9@SI=?}
← (AUDSRC#9@SI=C;)CrLf
```

The actual setting is in the response; see the legend for the details.

## Setting the Parameters

### Command and Response

```
→ {:AUDSRC#<in>@<S/C/A>I=<aud_mode>}
← (AUDSRC#9@SI=<aud_mode>;)CrLf
```

### Example

```
→ {:AUDSRC#9@SI=B}
← (AUDSRC#9@SI=B;)CrLf
```

The new setting is in the response; see the Parameters for the details.

## Parameters #audio

<aud_mode>	Analog port	S/PDIF port	Parameter Description
<b>A</b> (default)	input	output	<b>Analog → DVI; Analog → S/PDIF</b> The analog signal is routed to the S/PDIF output and embedded in the HDMI stream.
<b>B</b>	input	output	<b>Analog → DVI; DVI → S/PDIF</b> The audio from the HDMI signal is deembedded to the S/PDIF output and the analog signal is embedded in the HDMI stream.
<b>C</b>	output	input	<b>DVI → Analog; S/PDIF → DVI</b> The audio from the HDMI signal is deembedded to the analog output and the S/PDIF input is embedded in the HDMI stream.
<b>D</b>	output	input	<b>S/PDIF → DVI; S/PDIF → Analog</b> The S/PDIF input signal is embedded in the HDMI stream and routed to the analog output.
<b>E</b>	output	output	<b>DVI → S/PDIF; DVI → Analog</b> The audio of the HDMI stream is deembedded to the S/PDIF and analog audio outputs.

## 7.9.8. Analog Audio I/O Port

### 7.9.8.1. Output Port Parameters

Query or set the analog audio output port parameters (signal levels).

#### Supported Boards

- MX-TPS-IB-A, -AP; MX-TPS-OB-A, -AP
- MX-4TPS2-4HDMI-IB-A; MX-4TPS2-4HDMI-IB-AP
- MX-HDMI-3D-IB-A, MX-HDMI-3D-OB-A
- MXD-UMX-IB

## Querying the Parameters

### Command and Response

```
→ {:AUDOUT#<in/out>@<S/C/A><I/O>=?}
← (AUDOUT#<in/out>@S<I/O>=<vol>;<bal>;<bass>;<treb>;<deemp>;<ph>;)CrLf
```

### Example

```
#audio #analogaudio #volume
→ {:AUDOUT#9@SI=?}
← (AUDOUT#9@SI=7800;50;0;0;0;0;)CrLf
```

The actual setting is in the response; see the legend for the details.

## Setting the Parameters

### Command and Response

```
→ {:AUDOUT#<in/out>@<S/C/A><I/O>=<vol>;<bal>;<bass>;<treb>;<deemp>;<ph>}
← (AUDOUT#<in/out>@S<I/O>=<vol>;<bal>;<bass>;<treb>;<deemp>;<ph>;)CrLf
```

### Example

```
→ {:AUDOUT#9@SI=x;x;6;6;x;x}
← (AUDOUT#9@SI=7800;50;6;6;0;0;)CrLf
```

The 'Bass' and 'Treble' parameters changed to '6', the others left unchanged.

## Legend

Identifier	Parameter Description	Parameter Values
<vol>	Volume level	Values are accepted between <b>0 and -78 dB</b> (step is 1 dB) and rounded. e.g. 8000 = -78 dB; 3625 = -36 dB
<bal>	Balance	Values are accepted between <b>0 and 100</b> (step is 1): e.g. 50 = center (default)
<bass>	Bass level	<b>Even values</b> are accepted between <b>0 and 24</b> , other values are rounded.
<treb>	Treble level	Accepted values: <b>0; 2; 4; 6</b> . Other values are rounded.
<deemp>	De-emphasis	<b>0</b> = de-emphasis is disabled <b>1</b> = de-emphasis is enabled
<ph>	The phase invert of the outgoing signal	<b>0</b> = disabled <b>1</b> = enabled



### 7.9.8.2. Input Port Parameters

Query or set the analog audio input port parameters (signal levels).

#### Supported Boards

- *MX-TPS-IB-A, -AP; MX-TPS-OB-A, -AP*
- *MX-4TPS2-4HDMI-IB-A; MX-4TPS2-4HDMI-IB-AP*
- *MX-HDMI-3D-IB-A; MX-HDMI-3D-OB-A*
- *MXD-UMX-IB*

#### Querying the Parameters

##### Command and Response

→ {:*AUDIN#<in/out>*@<S/C/A><I/O>=?}

← (*AUDIN#<in/out>*@S<I/O>=<vol>;<bal>;<gain>;<ph>;<res>;)CrLf

##### Example

→ {:*AUDIN#9@SI=?*}

← (*AUDIN#9@SI=6300;50;0;0;0*;)CrLf

The actual setting is in the response; see the legend for the details.

#### Setting the Parameters

##### Command and Response *#analogaudio #volume*

→ {:*AUDIN#<in/out>*@<S/C/A><I/O>=<vol>;<bal>;<gain>;<ph>;x}

← (*AUDIN#<in/out>*@S<I/O>=<vol>;<bal>;<gain>;<ph>;<res>;)CrLf

##### Example

→ {:*AUDIN#9@SI=0*}

← (*AUDIN#9@SI=0;50;0;0;0*;)CrLf

The 'Volume' is changed to 0 dB, the others left unchanged. *#gain*

#### Parameters

Identifier	Parameter Description	Parameter Values
<vol>	Volume level	Values are accepted between <b>-63 and 0 dB</b> (step is 1 dB) and rounded. e.g. 6000 = -60 dB; 3625 = -36 dB
<bal>	Balance	Values are accepted between <b>0 and 100</b> (step is 1): e.g. 50 = center (default)
<gain>	Gain (input volume level)	Accepted values: <b>0, 3, 6, 9, 12, 15, 18, 21, 24</b>
<ph>	The phase invert of the outgoing signal	<b>0</b> = disabled <b>1</b> = enabled
<res>	Reserved	

### 7.9.9. DVI-DL Output Port

Query or set the dual-link DVI output port parameters.

#### Supported Boards

- *MX-DVIDL-OB*

#### 7.9.9.1. Port Parameters and Settings

##### Querying the Parameters

##### Command and Response

→ {:*ISL54105#<out>*@<S/C/A>O=?}

← (*ISL54105#<out>*@SO=<curr>;<preemp>;<band>;<mode>;)CrLf

##### Example

→ {:*ISL54105#9@SO=?*}

← (*ISL54105#9@SO=7;15;2;2*;)CrLf

The actual setting is in the response.

##### Setting the Parameters

##### Command and Response

→ {:*ISL54105#<out>*@<S/C/A>O=x;x;x;<mode>}

← (*ISL54105#<out>*@SO=<curr>;<preemp>;<band>;<mode>;)CrLf

##### Example

→ {:*ISL54105#9@SO=x;x;x;0*}

← (*ISL54105#9@SO=7;15;2;0*;)CrLf

The DVI port mode is changed to Dual link mode, the others left unchanged. Use the 'x' character to keep the actual value of a parameter.

#### Parameters

Identifier	Parameter Description	Parameter Values
<curr>	Output level	Port-related parameters (internal use)
<preemp>	PreEmphasis	
<band>	PLL bandwidth	
<mode>	DVI port mode (DL/SL)	<b>0</b> = Dual-link mode is active <b>1</b> = Single-link mode is active <b>2</b> = Auto mode (the dual-link half controlled automatically depending on the input signal)

The first three parameters are for internal use, type 'x' character instead and set the desired DVI port mode by the fourth parameter.

### 7.9.10. DVI-OPT Output Port

Query or set the DVI-OPT output port parameters.

#### Supported Boards

- MX-DVI-OPT-OB

#### 7.9.10.1. Port Parameters and Settings

##### Querying the Parameters

###### Command and Response

→ {TOSA#<out>@<S/C/A>O=?}

← (TOSA#<out>@SO=<laser>;<opt\_cod>;)CrLf

###### Example

→ {TOSA#9@SO=?}

← (TOSA#9@SO=1;C;4TCDP1081BT;LC;30;31;26;31;22;24;22;24;3;2;0)CrLf

The actual setting is in the response, see the legend.

##### Setting the Parameters

###### Command and Response

→ {TOSA#<out>@<S/C/A>O=<laser>;}

← (TOSA#<out>@SO=<laser>;<opt\_cod>;)CrLf

###### Example

→ {TOSA#9@SO=?}

← (TOSA#9@SO=1;C;4TCDP1081BT;LC;30;31;26;31;22;24;22;24;3;2;0)CrLf

The Laser has been enabled, the others left unchanged.

##### Parameters

Identifier	Parameter Description	Parameter Values
<laser>	Laser beam setting	0 = disable laser 1 = enable laser
<opt_cod>	Optical module-related parameters for internal use	

### 7.10. RICOD Related Commands

#### 7.10.1. Setting the RICOD MASTER Command

Sets the RICOD command for the selected input port.

##### Command and Response

→ {RICOD#<in>@<S/A>I=<A1><A2>;<B>;<C>;}

← (RICOD#<in>@SI=<A1><A2>;<B>;<C>;)CrLf

##### Parameters

Identifier	Parameter Description	Parameter Values
<in>	Input port number	Input number in 1 or 2 digit ASCII format (01, 3, 04 etc.)
<S/A>	Affected ports	<b>S</b> = single selected input <b>A</b> = all inputs
<A1>	RICOD enable parameter on the input	<b>1</b> : The RICOD function is enabled to this input port on the local device (where the command was given). <b>0</b> : The RICOD function is disabled to this input port on the local device (where the command was given).
<A2>	Remote lock enable parameter (it takes effect only if RICOD is enabled by <A1>)	<b>1</b> : The front panel buttons (of a transmitter) or the output (of a video matrix) is locked on the remote device. <b>0</b> : The front panel buttons (of a transmitter) or the output (of a video matrix) is unlocked on the remote device.
<B>	The selected video input	- (hyphen) = There is no video switch command. <b>A</b> = Automatic input select must be performed on the remote device if available. (i.e. Autoselect function) <b>0</b> (zero) = The output needs to be muted if available.(switch to zero) <b>1, 2, ... , 80</b> : Use the given input number if available.
<C>	The selected audio input	- (hyphen) = There is no video switch command. <b>A</b> = Automatic input select must be performed on the remote device if available. (i.e. Autoselect function) <b>0</b> (zero) = The output needs to be muted if available. <b>1, 2, ... , 80</b> : Use the given input number if available.

INFO: If the first character of <A1><A2> is zero, then no command is sent, the RICOD function is disabled on this input .

##### Example

→ {ricod#1@SI=10;2;1;}

← (RICOD#1@SI=10;2;1;)CrLf

RICOD control is enabled on the first input port, which unlocks the remote device and selects the second video input and the first audio input port on it.

### 7.10.2. Querying the Set RICOD MASTER

Checks the status of the previously set RICOD command for the selected input port.

#### Command and Response

```
→ {:RICOD#<in>@<S/A>I=?}
← (RICOD#<in>@SI=<A1><A2>;<B>;<C>;)CrLf
```

#### Parameters

See the previous section.

#### Example

```
→ {:ricod#1@si=?}
← (RICOD#1@SI=11;1;1;)CrLf
```

RICOD command was enabled on the first input port, which locks the remote device and selects the first video and audio input port on it.

### 7.10.3. Querying the RICOD SLAVE Status

Checks the previously set RICOD status for the selected output port of the local device.

#### Command and Response

```
→ {:RICOD_SLEN#<out>@<S/A>O=?}
← (RICOD_SLEN#<out>@SO=<num>)CrLf
```

#### Parameters

Identifier	Parameter Description	Parameter Values
<out>	Output port number	Output number in 1 or 2 digit ASCII format (01, 3, 04 etc.)
<S/A>	Affected ports	<b>S</b> = single selected input <b>A</b> = all inputs
<num>	RICOD enable parameter on the output	<b>1</b> : The RICOD functionality is enabled on the given output port. If a RICOD command is detected it will be executed.(If it is possible.) <b>0</b> : The RICOD functionality is disabled on the given output port. Any incoming RICOD command will be rejected.

#### Example

```
→ {:ricod_slen#1@SO=?}
← (RICOD_SLEN#1@SO=1)CrLf
```

RICOD functionality is enabled on the first output port on the local device.

### 7.10.4. Setting the RICOD SLAVE Status

Enables or disables the reception of RICOD commands over the selected output port of the local device.

#### Command and Response

```
→ {:RICOD_SLEN#<out>@<S/A>O=<num>}
← (RICOD_SLEN#<out>@SO=<num>)CrLf
```

#### Parameters

See previous section.

#### Example

```
→ {:ricod_slen#1@SO=1}
← (RICOD_SLEN#1@SO=1)CrLf
```

RICOD functionality is enabled on the first output port on the local device.

## 7.11. RS-232 over Fiber Commands

**ATTENTION!** The control interfaces on the router (USB, IP, and RS232) have 57600 bit/sec maximum bandwidth, so heavy traffic should be avoided. Try to reduce the responses and status messages coming from the end point to avoid the overload of the data transmission (e.g. see the **SERIAL** command in the [Setting the Serial Parameters](#) section).

**ATTENTION!** If the endpoint (the controlled device) sends more than 1 kbyte/sec without at least 600ms break between the data packets then the sent data could be lost.

### Important Notices

- The data rate can be 9600, 14400, 19200, 38400, 57600 baud. There is one stop bit and no parity bit.
- Maximum 64-byte data can be sent and 54-byte data can be received at once.
- There are two methods for sending data: ASCII and binary modes.
- HDMI-OPT-TX100R, HDMI-OPT-TX200R, MX-HDMI-OPT-IB: the baud rate can be set on the HDMI-OPT transmitter unit via a rotary switch.
- MX-HDMI-OPT-OB, HDMI-OPT-RX100R, HDMI-OPT-RX200R: the baud rate can be set on the router via protocol command or from the LCD menu. The baud rate can be set independently on each port.

### 7.11.1. Sending Data in Text Format

Sends the data from the matrix's input or output port in text format which is after the equal sign.

#### Command and Response

→ `{:S#<in2/out2>@<S>I/O=<ascii_text>}`

← *No response by the matrix*

#### Example

→ `{:s#17@so=Blind text\r\n}`

← *No response by the matrix*

'Blind text' with `CrLf` is sent out on the 17th output. The matrix does not response. If the remote controlled device responses the matrix is able to receive and show it.

#### Parameters

Identifier	Parameter Description	Parameter Values
<in2>/<out2>	Input or output port number	Output number in 1 or 2 digit ASCII format (01, 3, 04 etc.)
<l/O>	Input or output port type	<b>I</b> = input, <b>O</b> = output
<ascii_text>	ASCII text	Text to be sent

#### Important Notices about the Escape Characters

The text may contain any characters except "{" and "}" which are used for command framing. The following escape sequences are supported: `\r` (carriage return); `\n` (new line); `\t` (bs); `\x` [hex code].

#### Example

Send the `{power on}\r\n` string to the second output:

→ `{:S#2@SO=\x7Bpower on\x7D\r\n}`

It is possible to send the real characters (new line-carriage return) instead of `\r\n`, but curly brackets must be escaped. Other characters can also be escaped if it is preferred:

→ `{:S#1@SO=\x7Bpower\x20on\x7D\r\n}`

### 7.11.2. Sending Data in Binary Format

Sends the data from the matrix's input or output port in binary format which is after the equal sign.

#### Command and Response

→ `{:B#<in2/out2>@<S>I/O=<hex_string>}`

← *No response by the matrix*

#### Example

→ `{:b#17@so=0d0aad}`

← *No response by the matrix*

"0D0AAD" is sent out on the 17th output. The matrix does not response. If the remote controlled device responses the matrix is able to receive and show it.

#### Parameters

Identifier	Parameter Description	Parameter Values
<in2>/<out2>	Input or output port number	Output number in 1 or 2 digit ASCII format (01, 3, 04 etc.)
<l/O>	Input or output port type	<b>I</b> = input, <b>O</b> = output
<hex_string>	HEX string	String to be sent

Every 2 characters represent a hexadecimal code. The maximum length of the data is 64 characters, so the max length of the string is 128 char; any special character can be sent.

### Receiving Data from the Far Endpoint

Every port can operate either in ASCII or Binary mode. The mode can be set up with the `:SERIAL` command, see the next section. Depending on the selected mode, different messages are sent by the router when it receives data from the far endpoint. These messages arrive from the router asynchronously without any query command. (The router sends out the message immediately when it receives the data). Therefore it may happen that this message inserted between another command from the controller and the response from the router. The controller must be able to handle this case. See below example:

- **Controller:** `2@3} //sending a switch command`
- **Router:** `S#I3=Powered on} //asynchrony serial message`
- **Router:** `003 I02} //response to the switch command`



## ASCII

When the router receives a message, the next message will be sent to the controllers:

```
← (S#In=[received text])
```

or

```
← (S#On=[received text])
```

where n is the port number, I is the input, and O is the output port. See the example:

Far endpoint sends: Simple math: 2\[3-(2+8)]. Solve it!

The router sends:

```
← (S#I1=Simple math: 2\[3-\x282+8\x29]. Solve it!)
```

The received data is represented as plain ASCII text and the maximum length of it is 54 byte. The ( and ) characters are frame delimiters, so they cannot be inside a message. Therefore all ( characters will be replaced to \x28, while all ) will be replaced to \x29 escape sequences, while \ will be escaped as \\. No other characters will be escaped. If the programmer of the controller does not want to parse escape sequences (it is in fact just a sprintf(...) function call), the Binary mode should be used.

## Binary

```
← (B#In=[received text as binary data, e.g. 736F6D657468696E67])
```

or

```
← (B#On=[received text as binary data, eg. 736F6D657468696E67])
```

where n is the port number, I is the input, and O is the output port.

The received text is translated to binary form. The maximum length of the received text is 54 byte, so the length of the hex data can be up to 108 characters. See the example:

Far endpoint, connected to input port 1 is sending data, the router sends:

```
← (B#I1=736F6D657468696E67)
```

### 7.11.3. Querying the Serial Parameters

The properties of the serial pass-through can be queried on the input and the output side.

#### Command and Response

```
→ { :SERIAL#<in2/out2>@<S>I/O=? }
```

```
← (SERIAL#<in2/out2>@<S>I/O=<a>;<b>;<c>;<d>)CrLF
```

#### Example

```
→ { :serial#24@so=? }
```

```
← (SERIAL#24@SO=1;9600;1;1)CrLf
```

Serial pass-through sending and receiving is enabled on the 24th output port with 9600 baud.

## Parameters

Identifier	Parameter Description	Parameter Values
Read/write parameters		
<in2>/<out2>	Input or output port number	Port number in 1 or 2 digit ASCII format (01, 3, 04, etc.)
<l/O>	Input or output port type	<b>I</b> = input, <b>O</b> = output
<a>	Receiving is enabled	<b>0</b> : Incoming data is rejected. <b>1</b> : The incoming data is sent to the controllers in ASCII mode. (default) <b>2</b> : The incoming data is sent to the controllers in HEX mode.
<b>	Current baud rate	9600 (default), 14400, 19200, 38400, 57600
<c>	Serial pass-through enable	<b>1</b> : enabled, <b>0</b> : disabled
Read-only parameter		
<d>	The presence of a serial pass-through capable device	<b>1</b> : Serial link is active <b>0</b> : There is no active serial link

### 7.11.4. Setting the Serial Parameters

The properties of the serial pass-through can be modified on the input and the output side.

#### Command and Response

```
→ { :SERIAL#<in2/out2>@<S>I/O=<a>;<b>;<c>;<d> }
```

```
← (SERIAL#<in2/out2>@<S>I/O=<a>;<b>;<c>;<d>)CrLf
```

#### Example

```
→ { :serial#24@so=1;9600;1;1 }
```

```
← (SERIAL#24@SO=1;9600;1;1)CrLf
```

Serial pass-through sending and receiving is enabled on the 24th output port with 9600 baud.

#### Parameters

See the previous section.

## 7.12. RS-232 over TPS Commands

INFO: The control interfaces on the router (USB, IP and RS232) have 57600 bit/sec maximum bandwidth, so heavy traffic should be avoided.

**ATTENTION!** If the endpoint (the controlled device) sends more than 54 bytes at once without at least 100ms break between the data packets then the sent data could be lost.

### Important Notices

- Maximum 128-byte data can be sent and 64-byte data can be received at once.
- There are two methods for sending data: ASCII and binary modes.
- The data rate can be 9600, 14400, 19200, 38400, 57600 baud. The number of the stop bit(s) and the parity can be set up as well.
- If the TPS link operation is HDBaseT (and not long reach) mode and if there is no video signal transmission then the link can only operate on 9600 baud data rate.
- The communication parameters are not detected automatically, so the right values must be set for both the input and the output boards.

### 7.12.1. Sending Data in Text Format

Sends the data from the matrix's input or output port in text format which is after the equal sign.

#### Command and Response

→ `{:S#<in2/out2>@<S>I/O=<ascii_text>}`

← *No response from the matrix*

#### Example

→ `{:s#9@so=Blind text\r\n}`

← *No response from the matrix*

'Blind text' with `CrLf` is sent out on the 9th output. The matrix does not response. If the remote controlled device responses, the matrix is able to receive and show it.

#### Parameters

Identifier	Parameter Description	Parameter Values
<in2>/<out2>	Input or output port number	Output number in 1 or 2 digit ASCII format (01, 3, 04 etc.)
<l/O>	Input or output port type	<b>I</b> = input, <b>O</b> = output
<ascii_text>	ASCII text	Text to be sent

#### Important Notices about the Escape Characters

The text may contain any characters except '{' and '}' which are used for command framing. The following escape sequences are supported: `\r` (carriage return); `\n` (new line); `\t` (bs); `\x` [hex code].

#### Example

Send the `{power on}\r\n` string to the second output:

→ `{:S#2@SO=\x7Bpower on\x7D\r\n}`

It is possible to send the real characters (new line-carriage return) instead of `\r\n`, but curly brackets must be escaped. Other characters can also be escaped if it is preferred:

→ `{:S#1@SO=\x7Bpower\x20on\x7D\r\n}`

### 7.12.2. Sending Data in Binary Format

Sends the data from the matrix's input or output port in binary format.

#### Command and Response

→ `{:B#<in2/out2>@<S>I/O=<hex_string>}`

← *No response by the matrix*

#### Example

→ `{:b#9@so=0d0aad}`

← *No response by the matrix*

'0D 0A AD is sent out on the 9th output. The matrix does not response. If the remote controlled device responses the matrix is able to receive and show it.

#### Parameters

Identifier	Parameter Description	Parameter Values
<in2/out2>	Input or output port number	Output number in 1 or 2 digit ASCII format (01, 3, 04 etc.)
<l/O>	Input or output port type	<b>I</b> = input, <b>O</b> = output
<hex_string>	HEX string	String to be sent

Every 2 characters represent a hexadecimal code. The maximum length of the data is 64 characters, so the max length of the string is 128 char. With this method, it is possible to send any special characters.

#### Receiving Data from the Far Endpoint

Every port can operate either in ASCII or Binary mode. The mode can be set up with the `:SERIAL` command, see the next section. Depending on the selected mode, different messages are sent by the router when it receives data from the far endpoint. These messages arrive from the router asynchronously without any query command. (The router sends out the message immediately when the data is received). Thus it may happen that the message inserted between another command from the controller and the response from the router. The controller must be able to handle this case. For example a simple switch:

- Controller:** `{2@3}` //sending a switch command
- Router:** `(S#13=Powered on)` //asynchrony serial message
- Router:** `(003 I02)` //response to the switch command

## ASCII

When the router receives a message, the next message will be sent to the controllers:

← (S#In=[received text])

or

← (S#On=[received text])

where **n** is the port number, **I** is the input, **O** is the output port. See the example:

Far endpoint sends: Simple math: 2\[3-(2+8)]. Solve it!

The router sends:

← (S#I1=Simple math: 2\[3-\x282+8\x29]. Solve it!)

The received data is represented as plain ASCII text and the maximum length of it is 54 byte. The ( and ) characters are frame delimiters, so they cannot be inside a message. Therefore all ( characters will be replaced to \x28, while all ) will be replaced to \x29 escape sequences, while \ will be escaped as \\. No other characters will be escaped. If the programmer of the controller does not want to parse escape sequences (it is in fact just a sprintf(...) function call), the Binary mode should be used.

## Binary

← (B#In=[received text as binary data, e.g. 736F6D657468696E67])

or

← (B#On=[received text as binary data, eg. 736F6D657468696E67])

where **n** is the port number, **I** refers input, **O** stands for the output ports.

The received text is translated to binary form. The maximum length of the received text is 54 byte, so the length of the hex data can be up to 108 characters.

**Example:** Far endpoint, connected to input port 1 is sending data, the router sends:

(B#I1=736F6D657468696E67)

### 7.12.3. Querying the Serial Parameters

The properties of the serial pass-through can be queried on the input and the output side.

#### Command and Response

→ {SERIAL#<in2/out2>@<S>I/O=?}

← (SERIAL#<in2/out2>@<S>I/O=<a>;<b>;<c>)CrLf

#### Example

→ {serial#9@so=?}

← (SERIAL#9@SO=1;9600;8N1)CrLf

Serial pass-through sending and receiving is enabled on the 9th output port with 9600 baud.

## Parameters

Identifier	Parameter Description	Parameter Values
<in2/out2>	Input or output port number	Output number in 1 or 2 digit ASCII format (01, 3, 04 etc.)
<I/O>	Input or output port type	<b>I</b> = input, <b>O</b> = output
<a>	Receiving mode	<b>0</b> : Disabled (incoming data is ignored but sending is allowed) <b>1</b> : The incoming data is sent to the controllers in ASCII mode. (default) <b>2</b> : The incoming data is sent to the controllers in HEX mode.
<b>	Current baud rate	9600, 14400, 19200, 38400, 57600 (default), 115200
<c>	Port setting (in standard format e.g. 8N1)	1st character: number of data bits: <b>5</b> , <b>6</b> , <b>7</b> or <b>8</b> (default) 2nd character: parity bit. Possible values are: <b>N</b> : No parity (default) <b>O</b> : Odd parity <b>E</b> : Even parity <b>M</b> : Fixed high (Mark) <b>S</b> : Fixed low (Space) 3rd character: number of stop bits: <b>1</b> (default) or <b>2</b>

### 7.12.4. Setting the Serial Parameters

The properties of the serial pass-through can be modified on the input and the output side.

#### Command and Response

→ {SERIAL#<in2/out2>@<S>I/O=<a>;<b>;<c>}

← (SERIAL#<in2/out2>@<S>I/O=<a>;<b>;<c>)CrLf

#### Example

→ {serial#9@so=1;9600;8n1}

← (SERIAL#9@SO=1;9600;8N1)CrLf

Serial pass-through sending and receiving is enabled on the 9th output port with 9600 baud.

#### Parameters

See the previous section.

## 7.13. Router Initiated Commands

### 7.13.1. EDID Status Changed

This is sent after any command which changed the EDID table (EDID copy, EDID switch), or if a new EDID source e.g. a new display device is connected to the router.

#### Command and Response

→ *various*

← (E\_S\_C)CrLf

#### Example

→ *A new monitor is connected to the output*

← (E\_S\_C)CrLf

When a new monitor is connected to an output port, its EDID is read. The message from the router shows that an EDID has changed.

INFO: The router stores the last attached display device's EDID connected to the output. After disconnecting this device its EDID is still present at the router's memory, therefore no status change message is issued by the router if a display device having the same EDID is connected to that output. (The same display device is connected again, or another display device (same brand) from the same manufacturer).

INFO: To keep your application in sync with the router it is recommended to issue a watch validity ( {wvd}, {wvu}, {wve} ) command after receiving an (E\_S\_C) response, and read all location indicating '2' or '3' in the table, as the change of these EDIDs triggered the (E\_S\_C) message.

### 7.13.2. Port Status Changed (PSC)

This message is sent when any value changes in the response for the {PS} command. The message means that an input or output port's state has changed e.g. a source or display device is connected or disconnected.

#### Command and Response

→ *none*

← (PSC)CrLf

#### Example

→ *An input port loses signal*

← (PSC)CrLf

An input port (which had signal present before) detects no signal. The router sends a message to indicate port status change.

INFO: The (PSC) message can be omitted by a third party controller, or it can be used to trigger a {PS} command. In the latter case, the controller can be up to date with the port status without continuous queries.

### 7.13.3. Error Responses

Response	Error type	Description
(ERR01)CrLf	Invalid input number	Given input number exceeds the maximum number of inputs or equals zero.
(ERR02)CrLf	Invalid output number	Given output number exceeds the installed number of outputs or equals zero.
(ERR03)CrLf	Invalid value	Given value exceeds the maximum allowed value can be sent.
(ERR04)CrLf	Invalid preset number	Given preset number exceeds the maximum allowed preset number.



## 7.14. Commands – Quick Summary

### Switching and Control Commands

#### Selecting the 80th Input Port (MX-FR80R)

→ {TI=<value>}

#### Switching an Input to an Output

→ {<in>@<out>}

→ {<in>@<out>}

#### Switching an Input to All Outputs

→ {<in>@0}

#### Diagonal Switching

→ {<in>@D}

#### Displaying the Current Connection States of the Outputs

→ {VC}

#### Listing the Mute/Unmute States of All Outputs

→ {VM}

#### Muting a Specified Output

→ {#<out>}

#### Unmuting a Specified Output

→ {+<out>}

#### Disconnecting an Output

→ {0@<out>}

#### Disconnect All Outputs

→ {0@0}

#### Locking a Specified Output

→ {#><out>}

#### Unlocking a Specified Output

→ {+<<out>}

#### Saving a Preset

→ {\$<id>}

#### Loading a Preset

→ {%<id>}

#### Preset Preview

→ {VP#<id>=?}

#### Renaming a Preset

→ {PNAME#<id>= <preset\_name>}

#### Renaming an Input

→ {INAME#<in>=<input\_name>}

#### Renaming an Output

→ {ONAME#<out>=<output\_name>}

#### Querying the Name of a Preset

→ {PNAME#<id>=?}

#### Querying the Name of an Input

→ {INAME#<in>=?}

#### Querying the Name of an Output

→ {ONAME#<out>=?}

#### Reloading the Default Preset Names

→ {PNAME#<id>=!}

#### Reloading the Default Input Names

→ {INAME#<id>=!}

#### Reloading the Default Output Names

→ {ONAME#<id>=!}

### Communication Setup Commands

#### Querying the IP Settings

→ {IP\_CONFIG=?}

#### Reloading the Default IP Settings

→ {IP\_CONFIG=!}

#### Setting a Dynamic IP Address (DHCP)

→ {IP\_CONFIG=D}

#### Querying the RS-232 Baud Rate

→ {RS232BAUD=?}

#### Changing the RS-232 Baud Rate

→ {RS232BAUD=<rate>}

#### Querying the Control Protocol

→ {P\_?}

#### Changing the Control Protocol

→ {P\_<protocol>}

#### Configure Remote Alerts

→ {ELEVELSEND#<p>= <0>;<1>;<2>;<3>;<4>}

### Router Status Commands

#### Querying the Product Type

→ {I}

#### Querying the Serial Number

→ {S}

#### Querying the Firmware Version of the CPU

→ {F}

#### Querying the CPU Firmware Compile Time

→ {CT}

#### Querying the Crosspoint Size

→ {GETSIZE}

#### Querying the Number of the Allowed I/O Slots

→ {MAXSLOTS=?}

#### Querying the Installed I/O Boards

→ {IS}

#### Querying the Firmware of All Controllers'

→ {FC}

#### Querying the LAN Versions

→ {LAN\_VER=?}

#### Querying the Health Status

→ {ST}

#### Querying the Error List

→ {ELIST=?}

### System Commands

#### Restarting the Matrix

→ {RST}

#### Querying the CPU Time

→ {GETTIME}

**Setting the CPU Time**

→ {SETTIME=<date>•<time>•UTC+<zone>}

**Switching the Matrix to Standby**

→ {PWR\_<state>}

**Reloading the Factory Default Values and Settings**

→ {FACTORY=<f1>;<f2>;...;<fx>}

**EDID Router Commands****Changing the EDID on an Input Port**

→ {<destination>:<source>}

**Changing the EDID on All Inputs**

→ {EA:<source>}

**Saving an EDID to the User Memory**

→ {<destination>:<source>}

**Querying the EDID Validity Table**

→ {WV<type>}<val\_table>CrLf

**Querying the Emulated EDIDs on All Inputs**

→ {VEDID}

**Querying the Header of an EDID**

→ {WH<loc>}

**Deleting an EDID From the Memory**

→ {DE<loc>}

**Downloading the Content of an EDID**

→ {WE<loc>}

**Uploading the EDID Content**

→ {WL#<loc>}

→ {WB#1•<B1>•<B2>•<B3>•<B4>•<B5>•<B6>•<B7>•<B8>}

→ {WB#2•<B9>•<B10>•<B11>•<B12>•<B13>•<B14>•<B15>•<B16>}

→ ...

→ {WB#32•<B249>•<B250>•<B251>•<B252>•<B253>•<B254>•<B255>•<B256>}

**Port Status Commands****Input Port Status**

→ {ISD}

**Output Port Status**

→ {OSD}

**All Port Status**

→ {PS}

**I/O Port Commands****TPS and TPS2 Port****Port Parameters and Settings**

→ {TPS#<in/out>@<S><I/O>=?}

→ {TPS#<in/out>@<S><I/O>=<mod>;<eth>}

**Remote Power Settings (PoE)**

→ {POE#<in/out>@S<I/O>=?}

→ {POE#<in/out>@S<I/O>=<mode>;<status>}

**HDMI Input Port****Port Parameters and Settings**

→ {HDMI#<in>@<S/C/A>I=?}

→ {HDMI#<in>@<S/C/A>I=<a><b>}

**Timing Parameters**

→ {TIMINGS#<in>@<S/C/A>I=?}

**HDMI-3D Input Port****Port Parameters and Settings**

→ {HDMI#<in>@<S/C/A>I=?}

→ {HDMI#<in>@<S/C/A>I=X;<HDCP\_mode>;<TPG\_mode>;<TPG\_clock>;<TPG\_screen>;<Audio\_mode>}

**Timing Parameters**

→ {TIMINGS#<in>@<S/C/A>I=?}

**HDMI Output Port****Port Parameters and Settings**

→ {HDMI#<out>@<S/C/A>O=?}

→ {HDMI#<out>@<S/C/A>O=<a>;<b>;<c>;<d>;<e>;}

**Timing Parameters**

→ {TIMINGS#<in>@<S/C/A>I=?}

**HDMI-3D Output Port****Port Parameters and Settings**

→ {HDMI#<out>@<S/C/A>O=?}

→ {HDMI#<out>@<S/C/A>O=<sig\_type>;x;x;x;<HDCP\_mode>;<TPG\_mode>;<TPG\_clk>;<TPG\_screen>;

→ <A\_mode>;<PWR\_5V>}

**Timing Parameters**

→ {TIMINGS#<in>@<S/C/A>I=?}

**DVI-I Input Port****Port Parameters and Settings**

→ {DVII#<in>@<S/C/A>I=?}

→ {DVII#<in>@<S/C/A>I=?}

→ {DVII#<in>@<S/C/A>I=<src>;<sig\_type>;<aud>;<hdcp>;}

**Test Pattern Settings**

→ {SETBG#<in>@<S/C/A>I=?}

→ {SETBG#<in>@<S/C/A>I=<rgb\_color>;}

→ {GETTIMINGS#<in>@<S/C/A>I=?}(SETBG#<in>@<S/C/A>I=<rgb\_color>;)CrLf

**UMX Input Port****Audio Source Selection**

→ {AUDSRC#<in>@<S/C/A>I=?}

→ {AUDSRC#<in>@<S/C/A>I=<aud\_mode>}

**Analog Audio I/O Port****Output Port Parameters**

→ {AUDOUT#<in/out>@<S/C/A><I/O>=?}

→ {AUDOUT#<in/out>@<S/C/A><I/O>=<vol>;<bal>;<bass>;<treb>;<deemp>;<ph>}

**Input Port Parameters**

→ {AUDIN#<in/out>@<S/C/A><I/O>=?}

→ {AUDIN#<in/out>@<S/C/A><I/O>=<vol>;<bal>;<gain>;<ph>;x}

**DVI-DL Output Port****Port Parameters and Settings**

→ {ISL54105#<out>@<S/C/A>O=?}

→ {ISL54105#<out>@<S/C/A>O=x;x;x;<mode>}

**DVI-OPT Output Port****Port Parameters and Settings**

- { :TOSA#<out>@<S/C/A>O=? }
- { :TOSA#<out>@<S/C/A>O=<laser>; }

**RICOD Related Commands****Setting the RICOD MASTER Command**

- { :RICOD#<in>@<S/A>I=<A1><A2>;<B>;<C>; }

**Querying the Set RICOD MASTER**

- { :RICOD#<in>@<S/A>I=? }

**Querying the RICOD SLAVE Status**

- { :RICOD\_SLEN#<out>@<S/A>O=? }

**Setting the RICOD SLAVE Status**

- { :RICOD\_SLEN#<out>@<S/A>O=<num> }

**RS-232 over Fiber Commands****Sending Data in Text Format**

- { :S#<in2/out2>@<S>I/O=<ascii\_text> }

**Sending Data in Binary Format**

- { :B#<in2/out2>@<S>I/O=<hex\_string> }

**Querying the Serial Parameters**

- { :SERIAL#<in2/out2>@<S>I/O=? }

**Setting the Serial Parameters**

- { :SERIAL#<in2/out2>@<S>I/O=<a>;<b>;<c>;<d> }

**RS-232 over TPS Commands****Sending Data in Text Format**

- { :S#<in2/out2>@<S>I/O=<ascii\_text> }

**Sending Data in Binary Format**

- { :B#<in2/out2>@<S>I/O=<hex\_string> }

**Querying the Serial Parameters**

- { :SERIAL#<in2/out2>@<S>I/O=? }

**Setting the Serial Parameters**

- { :SERIAL#<in2/out2>@<S>I/O=<a>;<b>;<c> }

# 8

## Firmware Upgrade

This chapter is meant to help customers perform firmware upgrades on MX-FR products by giving a few tips on how to start and by explaining the features of the Bootloader software. To get the latest software and firmware pack please contact [support@lightware.com](mailto:support@lightware.com).

- ▶ [DETAILED INSTRUCTIONS OF THE UPGRADE](#)
- ▶ [FORCED FIRMWARE UPGRADE](#)
- ▶ [FIRMWARE UPGRADE OF TPS\(2\) PORTS](#)

### 8.1. Detailed Instructions of the Upgrade

Use the Lightware Bootloader application to upgrade the router's firmware(s). The matrix router can only be upgraded via LAN, so connect the matrix router to the local subnet or directly to the windows based computer with an Ethernet cross-link cable. Be sure that there is no other active connection with the router via Ethernet.

**Step 1.** Installing the bootloader application (contact [support@lightware.com](mailto:support@lightware.com)).

**Step 2.** Downloading all the firmware files that you want to upgrade. If you have a zipped archive, extract it.

**Step 3.** Connecting the Lightware device and the computer via LAN port.

**Step 4.** Starting the Lightware Bootloader application.

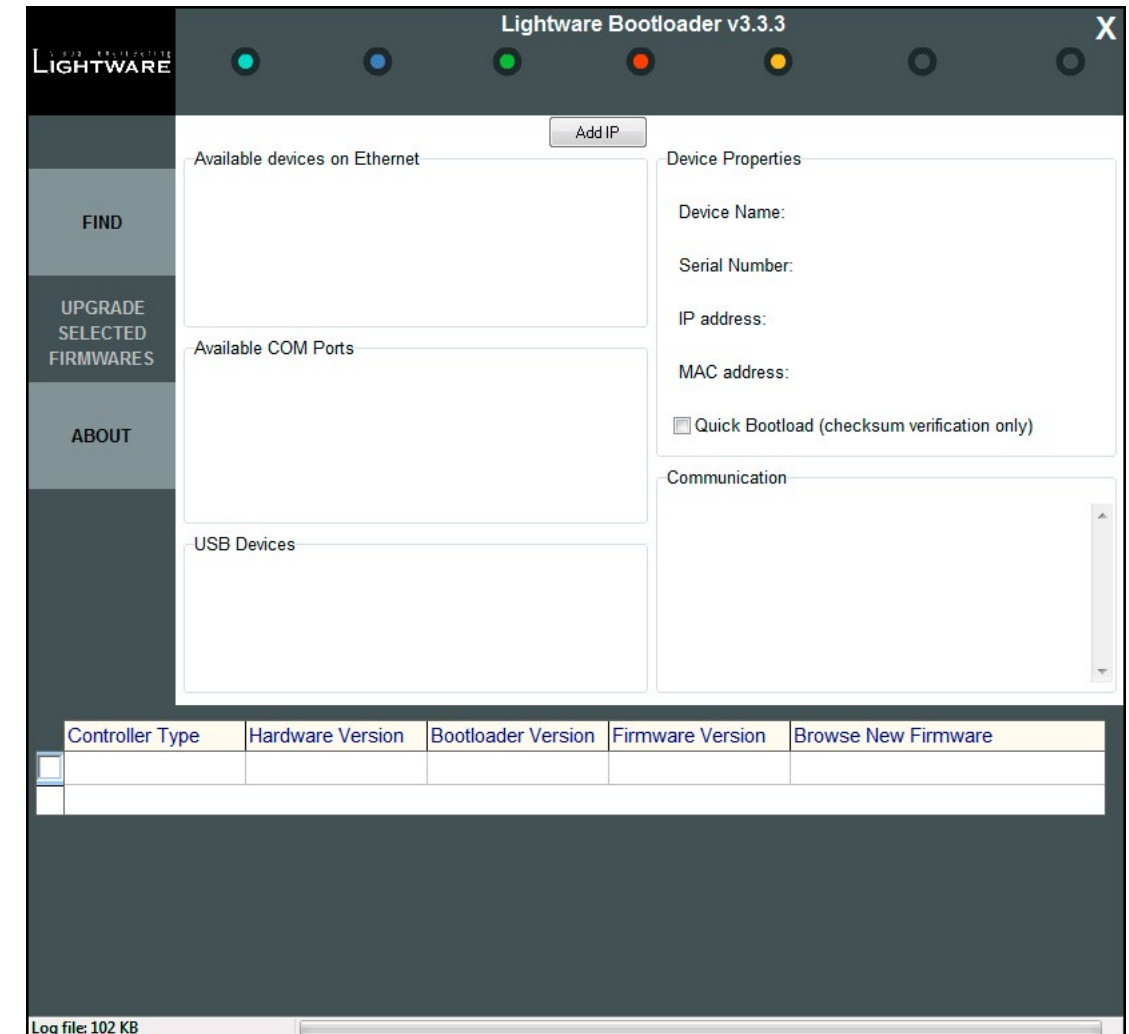



**Step 5.** Finding the device.

If the bootloader finds one or more routers their IP addresses, type and serial number are listed in the tree view window. Press the Find button.

**ATTENTION!** Please note, that you have to wait until all the devices on the network completely start up, before pressing the Find button.

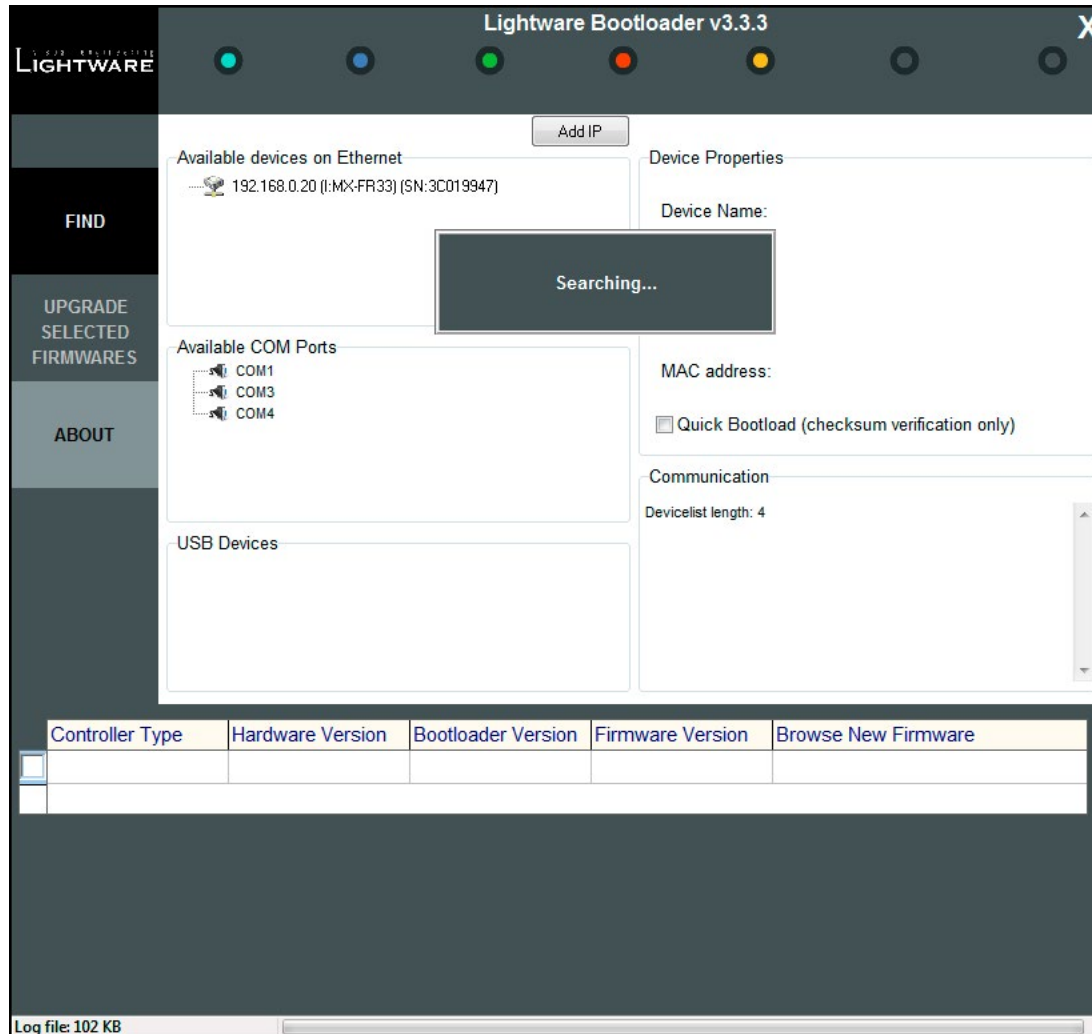

**Step 6.** Establishing the connection with the device.

Double click on the IP address, then click **Yes** to establish connection with the matrix router. It will take 10-15 seconds to get all information from the router.

**ATTENTION!** The bootloader application will restart the router when it establishes the connection. All connected DVI sources and monitors will act as if the router was powered down. The matrix beeps when it is rebooted.

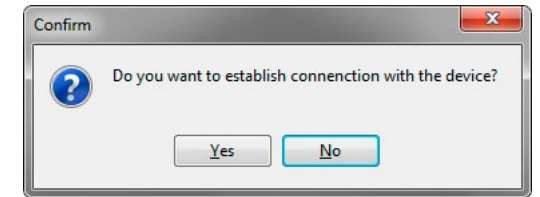

**Step 7.** Review the firmware versions.

After the connection is made, the device properties, and the installed controller modules are displayed. Select the desired controllers which need firmware upgrade by clicking the checkbox(es).

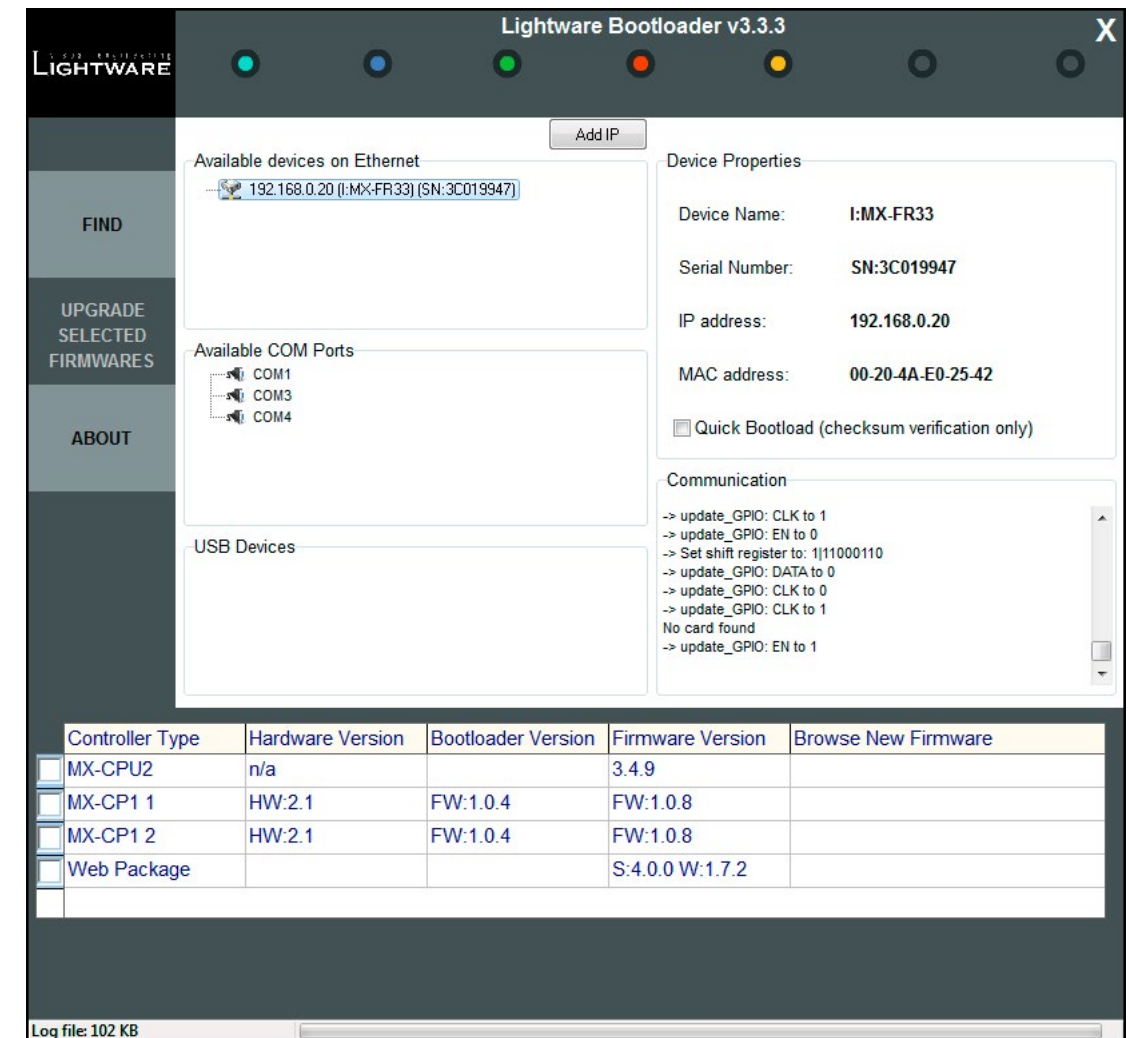

MX-CPU2 is the main processor's firmware. MX-CP controllers are the front panel button modules. The number of the MX-CP modules depends on the matrix frame size. These modules must have the same firmware installed. The Web Package is the module which handles the LAN connections and hosts the built-in website.

**Step 8.** Browse for the new firmware(s).

Click the corresponding cell in the **Browse New Firmware** column. A dialog pops up, to confirm if you really want to modify the path. Now you can browse for the new firmware file to upload. After opening the new file, the new firmware field will contain the name of the firmware file.

Controller Type	Hardware Version	Bootloader Version	Firmware Version	Browse New Firmware
<input checked="" type="checkbox"/> MX-CPU2	n/a		3.4.9	MX-CPU2_CPU_v3.5.3b2.hex
<input type="checkbox"/> MX-CP1 1	HW:2.1	FW:1.0.4	FW:1.0.8	
<input type="checkbox"/> MX-CP1 2	HW:2.1	FW:1.0.4	FW:1.0.8	
<input type="checkbox"/> Web Package			S:4.0.0 W:1.7.2	

**Step 9.** Upgrade firmware(s)

Click **Upgrade selected firmwares** button. A confirmation message appears. After clicking the **Yes** button the selected controllers are being reprogrammed, with the firmware you selected. If you select a file that does not fit for the selected controller, you will get an information message about which file is wrong. If you selected a controller to upgrade, but you had not selected a file for it, then you will also get an information message about which file is missing.

Quick Bootload mode can be switched on or off any time. No data verification is done after writing if the checksum was correct which makes the bootloader faster..

**ATTENTION!** The reprogramming may take 3-8 minutes per controller.

A progress bar will show the current state of the reprogramming on the bottom of the window. In the case of certain boards first the erasing process is run before the programming, so the progress bar runs up twice.



When the reprogramming is finished, a Done! message will appear in the bottom left corner. The application closes the connection, and the router restarts.

**Step 10.** Done!

If the upgrade was successful, a window pops up. Now you can close the application, or you can select another matrix router to upgrade. After closing the bootloader application, switch the upgraded devices off and then on. Now the router is ready to be used with the new firmware!

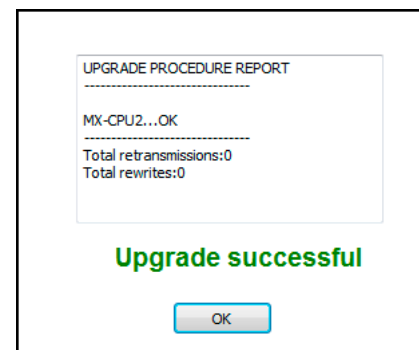

## 8.2. Forced Firmware Upgrade

If a previous upgrade process has failed or the matrix is not listed in the available device list then the normal firmware upgrading process may not work. In this case the below procedures can help.

### Device Not Listed

The IP address of a matrix may not be listed in the list because of wrong network configuration or if a previous upgrade process failed. In this case the router's IP address can be added manually to the list with the Add IP button.

**ATTENTION!** Use this option with caution as the manually typed IP address is not checked if it is a Lightware device or not. If the address belongs to an unknown network device then this may cause malfunction of the device.

**Step 1.** Type the IP address of the matrix router (check on the front panel LCD if possible).

**Step 2.** The TCP port can be selected manually if the checkbox is selected. If the port is not set then the default port 10001 is used.

**Step 3.** Click the Add button. The IP address will appear in the list.

### Cannot Connect to Device

If the IP address was added manually then the bootloader software usually cannot detect the device type and cannot connect to it automatically. The IP addresses with unrecognized devices appear in the list without showing the type and serial number.

**ATTENTION!** Use this option with caution as the manually typed IP address is not checked if it is a Lightware device or not. If the address belongs to an unknown network device then this may cause malfunction of the device.

**Step 1.** Add the IP address manually as described above.

**Step 2.** Right click on the desired IP address and select Handle as MX-CPU2.

**Step 3.** The software tries to connect to the device handling it as the selected type. If the connection is successful then the further process is the same as the normal firmware upgrade.

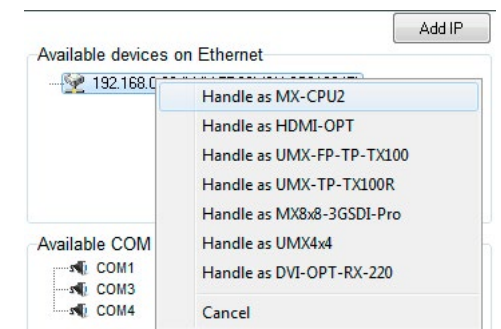

### 8.3. Firmware Upgrade of TPS(2) Ports

All MX-TPS and TPS2 I/O board's port has a separate firmware. All of the 8 firmwares can be different version and they are stored on the board instead of the MX-CPU2. Therefore the firmware upgrade must be performed differently than MX-CPU2. The firmware upgrade can be performed with the Lightware Device Controller software.

**INFO:** All settings of the matrix remains after TPS firmware upgrade.

#### Upgrading Steps in a Nutshell

- Step 1.** Download and save all the firmware files that you want to upgrade.
- Step 2.** Connect the Lightware device and the computer via LAN port.
- Step 3.** Start the Lightware Device Controller application.
- Step 4.** Establish the connection with the device.
- Step 5.** Open the input or output parameters window.
- Step 6.** Click on the Firmware upgrade button.
- Step 7.** Upload the firmware files to the SD card.
- Step 8.** Select the desired ports.
- Step 9.** Starting the upgrade process.
- Step 10.** Restart the device.

#### Detailed Instructions

The TPS(2) boards can be upgraded with the LDC software.

**WARNING! Performing the upgrade process via the LAN connection is strongly recommended.**

- Step 1.** Download and save all the firmware files that you want to upgrade. If you have a zipped archive, extract it.
- Step 2.** Make sure the LDC software is installed on your computer.
- Step 3.** Start the LDC and establish the connection with the matrix.
- Step 4.** Open the TPS firmware upgrade window.  
By clicking on any TPS input or output label a dialog window appears showing the parameters for the corresponding input or output port. The current firmware version can be seen in the Firmware settings section.

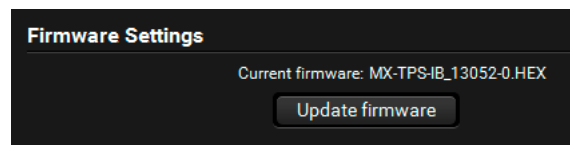

- Step 5.** Click the **Update Firmware** button; a new dialog window appears showing the uploaded firmwares and the available TPS ports. If the frame contains TPS input and output boards user can reach both one from this window.

Use the radio button to change between inputs and outputs.

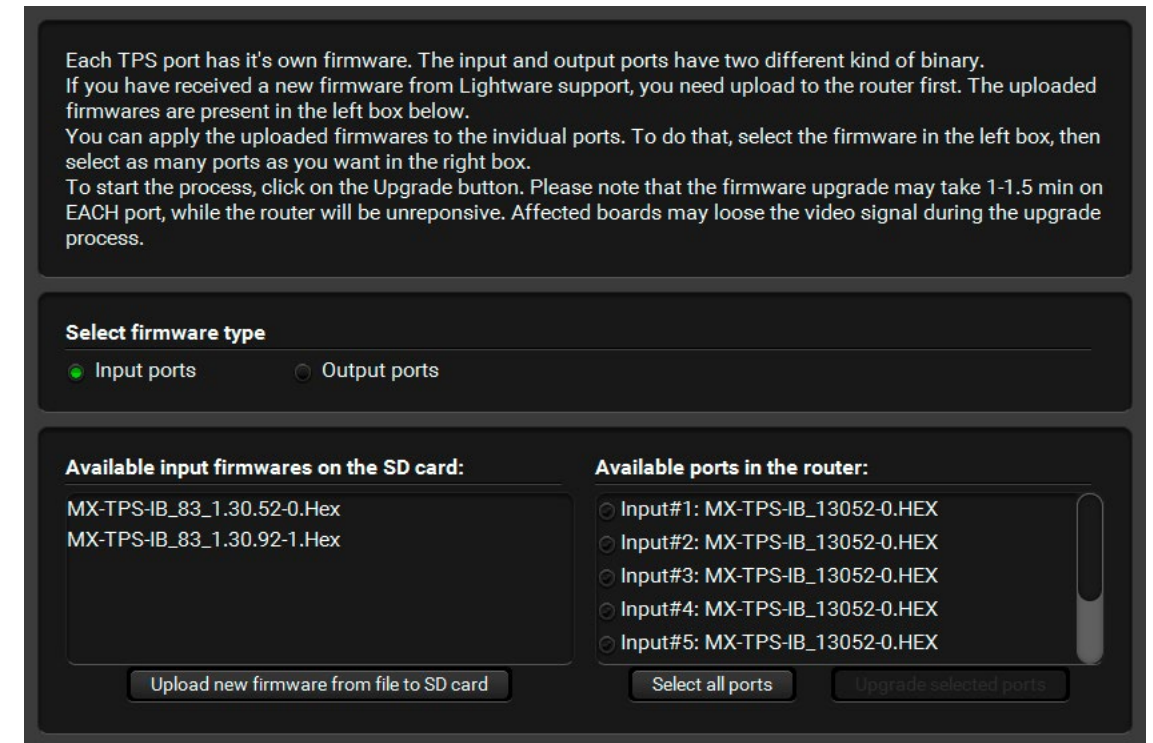

- Step 6.** Upload the firmware files to the SD card. Click on the Upload new firmware from file to SD card button and browse the file. Find the firmware file then click Open. A progress bar shows the current state of the process.

**WARNING! Do not close the software or disconnect the device before the upload is finished!**

**ATTENTION!** Only one firmware file can be uploaded at the same time. Repeat Step 6 for uploading another file.

- Step 7.** Select the desired ports to upgrade. Use the tick circles to select/deselect the ports.
- Step 8.** Start the upgrade process. Click on the **Upgrade selected ports**. It takes about 12 minutes if all the ports are upgraded on a board.

**WARNING! Do not turn off or disconnect your device before the upgrade is finished.**



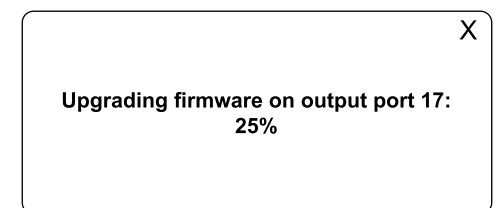
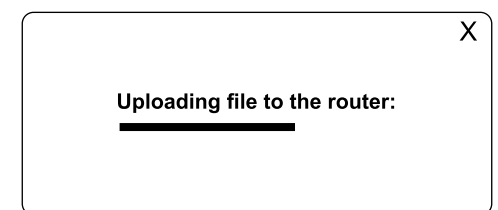

- Step 9.** Finish and restart. If the process is finished, the process indicator is changed to Firmware upgrade finished for a second. Close the LDC and restart the matrix.















# 9





## Troubleshooting

Usually, if the system seems not to transport the signal as expected, the best strategy for troubleshooting is to check signal integrity through the whole signal chain starting from source side and moving forward to receiver end.

-  Link to connections/cabling section.
-  Link to front panel operation section.
-  Link to LDC software section.
-  Link to LW2 protocol commands section.
-  Link to LW3 protocol commands section.

Symptom	Root cause	Action	Refer to
<b>General Problems</b>			
<b>CPU Link LED does not blink</b>	The matrix is not powered correctly	Reset the matrix by LW2 command, or unplug and reconnect the power cable.	 <a href="#">7.6.1</a> 
<b>General Video Signal Problems</b>			
<b>Picture is not displayed or distorted</b>	Video connectors are loose	Make sure the connectors fit well.	
	Different port is selected in the source/display device	Select the desired/connected port.	
	Analog signal is connected to a digital port	However, I/O boards equipped with DVI-I ports only the indicated ports accept analog signal.	 <a href="#">3.14.2</a>
	The desired input and output ports are not connected	Check the crosspoint state in the matrix.	 <a href="#">6.4</a>
	The desired output is muted	Unmute the port.	 <a href="#">6.4</a>
	The sink device is not able to display the image	Emulate another EDID (e.g. Lightware's Universal EDID)	 <a href="#">6.6</a>
<b>TCP/IP Connection Problems</b>			
<b>Cannot connect to the matrix or send a command via LAN</b>	Not the proper cable is applied	For direct connection use a cross-link cable, for connecting the matrix to a hub or switch use a straight patch cable.	
	Connected to a different network (e.g. Wi-Fi vs. LAN)	Check the settings of your computer and make sure it is connected to the same network as the matrix.	
	Improper IP address is applied in the matrix	Set the IP address manually for a direct connection.	 <a href="#">4.9.2</a>
	IP address conflict in the network	Check the current IP address; set a dynamic IP address if DHCP server is in the network.	 <a href="#">4.9.2</a>
	Incorrect port address is set	The matrix accepts LAN connection on the 10001 TCP port.	 <a href="#">4.9.2</a>
	The port is blocked by a firewall in the network	Check the firewall settings.	
	Not the right protocol is selected	Check the current protocol setting and set the desired option.	 <a href="#">4.10.5</a>



Symptom	Root cause	Action	Refer to
<b>Serial Connection Problems</b>			
<b>Cannot connect to the matrix or send a command via RS-232 port</b>	Not the right protocol is selected	Check the current protocol setting and set the desired option.	 4.10.5
	Not the right cable is plugged in	Check the connection: a straight-through male-female serial cable is needed.	 3.14.5
	Serial port settings do not meet	Set the same parameters in the matrix and in the connected serial device	 4.9.2
<b>TP/TPS port problems</b>			
<b>Picture is not displayed or distorted</b>	The CATx cable is connected to an Ethernet interface	Check the cable connections.	 2.2
	Low quality CATx cables applied	Due to high data rates, high quality cabled are recommended, CAT6 or CAT7 S/FTP cables.	
	The crimping of the CATx cables is not right	Check the wire colors of the connectors to meet the requirements.	 3.14.4

## 9.1. How to Speed Up the Troubleshooting Process

Lightware's technical support team is always working hard to provide the fastest support possible. Our team's response time is one of the best in the industry and in the toughest of cases we can directly consult with the hardware or software engineer who designed the product to get the information from the most reliable source.

However, the troubleshooting process can be even faster... with your help.

There are certain pieces of information that push us in the right direction to finding the root cause of the problem. If we receive most of this information in the first e-mail or it is gathered at the time when you call us, then there is a pretty high chance that we will be able to respond with the final solution right away.

### This information is the following:

- Schematic (a pdf version is preferred, but a hand drawing is sufficient).
- Serial number(s) of the device(s) (it is either printed somewhere on the box or you can query it in the Device Controller software or on the built-in website).
- Firmware versions of the devices (please note that there may be multiple CPUs or controllers in the device and we need to know all of their firmware versions, a screenshot is the best option).
- Cable lengths and types (in our experience, it's usually the cable).
- Patch panels, gender changers or anything else in the signal path that can affect the transmission.
- Signal type (resolution, refresh rate, color space, deep color).
- Emulated EDID(s) (please save them as file and send them to us).
- Actions to take in order to re-create the problem (if we cannot reproduce the problem, it is hard for us to find the cause).
- Photo or video about the problem ('image noise' can mean many different things, it's better if we see it too).
- Error logs from the Device Controller software.
- In the case of Event Manager issue the event file and/or backup file from the Device Controller software.

The more of the above information you can give us the better. Please send these information to the Lightware Support Team ([support@lightware.com](mailto:support@lightware.com)) to speed up the troubleshooting process.

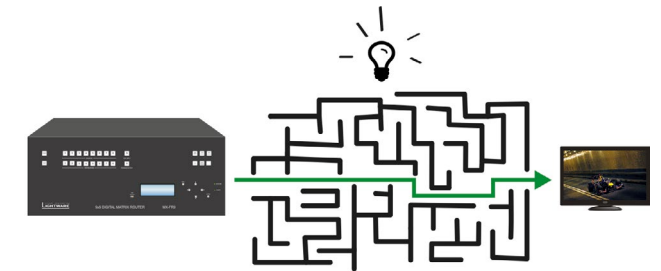

# 10

## Technologies

- ▶ EDID MANAGEMENT
- ▶ HDCP MANAGEMENT
- ▶ PIXEL ACCURATE RECLOCKING
- ▶ DUAL-LINK DVI SIGNAL
- ▶ RS-232 COMMAND TRANSMISSION
- ▶ THE RICOD TECHNOLOGY

### 10.1. EDID Management

#### 10.1.1. Understanding the EDID

The Extended Display Identification Data (EDID) is the passport of display devices (monitors, TV sets, projectors). It contains information about the capabilities of the display, such as supported resolutions, refresh rates (these are called Detailed Timings), the type and manufacturer of the display device, etc.

After connecting a source to a display (DVI, HDMI, DP), the source reads out the EDID to determine the resolution and refresh rate of the image to be transmitted.

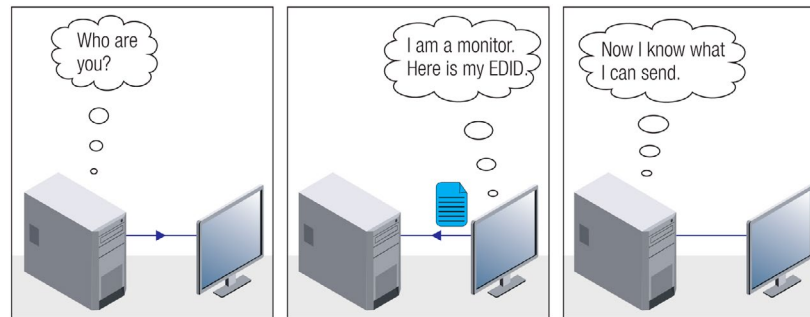

**EDID Communication**

Most DVI computer displays have 128-byte long EDID structure. However, Digital Televisions and HDMI capable displays may have another 128 bytes, which is called E-EDID and defined by CEA (Consumer Electronics Association). This extension contains information about additional Detailed Timings, audio capabilities, speaker allocation and HDMI capabilities. It is important to know that all HDMI capable devices must have CEA extension, but not all devices with CEA extension are HDMI capable.

#### Common Problems Related to EDID

**Problem:** “My system consists of the following: a computer, a Lightware device, a WUXGA (1920x1200) LCD monitor, and an SXGA (1280x1024) projector. I would like to see the same image on the monitor and the projector. What EDID should I choose on the Lightware device?”

**Solution:** If you want to see the image on both displays, you need to select the resolution of the smaller display (in this case SXGA), otherwise the smaller display may not show the higher resolution image.

**Problem:** “I have changed to a different EDID on an input port of the Lightware device to have a different resolution but nothing happens.”

**Solution:** Some graphics cards and video sources read out the EDID only after power-up and later they do not sense that EDID has been changed. You need to restart your source to make it read out the EDID again.

#### 10.1.2. Advanced EDID Management

Each DVI sink (e.g. monitors, projectors, plasma displays, etc...) must support the EDID data structure. Source BIOS and operating systems are likely to query the sink using DDC2B protocol to determine what pixel formats and interface are supported. DVI standard uses EDID data structure to identify the monitor type and capabilities. Most DVI sources (VGA cards, set top boxes, etc.) will output DVI signal after accepting the connected sink's EDID information. In the case of EDID readout failure or missing EDID, the source will not output DVI video signal.

Lightware devices provide the Advanced EDID Management function that helps system integration. The built-in EDID Router can store and emulate factory pre-programmed- and User programmable EDIDs. The EDID of the attached monitors or projectors for each output are stored in a non-volatile memory. This way the EDID of a monitor is available when the monitor is unplugged or switched off.

Any EDID can be emulated on any input. An emulated EDID can be copied from the EDID router's memory (static EDID emulation), or from the last attached monitor's memory (dynamic EDID emulation). For example, the Lightware device can be set up to emulate a sink device, which is connected to one of the outputs. In this case, the EDID automatically changes, if the monitor is replaced with another display device (as long as it has a valid EDID).

EDID is independently programmable for all inputs without affecting each other. All inputs have their own EDID circuit.

**INFO:** The user is not required to disconnect the video cable to change an EDID as opposed to other manufacturer's products. EDID can be changed even if a source is connected to the input and powered ON.

**INFO:** When EDID has been changed, the router toggles the HOTPLUG signal for 2 seconds. Some sources do not sense this signal. In such cases, the source device must be restarted or powered OFF and ON again.

## 10.2. HDCP Management

Lightware Visual Engineering is a legal HDCP adopter. Several functions have been developed which helps to solve HDCP related problems. Complex AV systems often have both HDCP and non-HDCP components. The matrix allows transmitting HDCP encrypted and unencrypted signals. The devices will be still HDCP compliant as they will never output an encrypted signal to a non-HDCP compliant display device. If an encrypted signal is switched to a non-compliant output, a red screen alert or muted screen will appear.

### 10.2.1. Protected and Unprotected Content

Many video sources send HDCP protected signal if they detect that the sink is HDCP capable – even if the content is not copyrighted. This can cause trouble if an HDCP capable device is connected between the source and the display. In this case, the content cannot be viewed on non-HDCP capable displays and interfaces like event controllers. Rental and staging technicians often complain about certain laptops, which are always sending HDCP encrypted signals if the receiver device (display, matrix router, etc.) reports HDCP compliance. However, HDCP encryption is not required all the time e.g. computer desktop image, certain laptops still do that.

To avoid unnecessary HDCP encryption, Lightware introduced the HDCP enabling/disabling function: the HDCP capability can be disabled in the Lightware device. If HDCP is disabled, the connected source will detect that the sink is not HDCP capable, and turn off authentication.

### 10.2.2. Disable Unnecessary Encryption

#### HDCP Compliant Sink



All the devices are HDCP-compliant, no manual setting is required, both protected and unprotected contents are transmitted and displayed on the sink.

#### Not HDCP-compliant Sink 1.



Not-HDCP compliant sink is connected to the matrix. Some sources (e.g. computers) always send HDCP encrypted signals if the receiver device reports HDCP compliance, however, HDCP encryption is not required all the time (e.g. computer desktop image). If HDCP is enabled in the matrix, the image will not be displayed on the sink.

Setting the HDCP parameter to Auto on the output port and disable HDCP on the input port, the transmitted signal will not be encrypted if the content is not protected. Thus, non-HDCP compliant sinks will display non-encrypted signal.

#### Not HDCP-compliant Sink 2.



The layout is the same as in the previous case: non-HDCP compliant display device is connected to the matrix but the source would send protected content with encryption. If HDCP is enabled on the input port of the matrix, the source will send encrypted signal. The sink is not HDCP compliant, thus, it will not display the video signal (but blank/red/muted/etc. screen). If HDCP is disabled on the input port of the matrix, the source will not send the signal. The solution is to replace the display device to an HDCP-capable one.

## 10.3. Pixel Accurate Reclocking

Signal reclocking is an essential important procedure in digital signal transmission. After passing the reclocking circuit, the signal becomes stable, jitter-free, and can be transmitted over more equipment like processors, or event controllers. Without reclocking, sparkles, noise, and jaggies appear on the image.

Lightware’s sophisticated Pixel Accurate Reclocking technology fixes more problems than general TMDS reclocking. It removes not only intra-pair skew but inter-pair skew as well. The Pixel Accurate Reclocking circuit eliminates the following errors:

### Intra-pair skew

Skew between the + and - wires within a differential wire pair (e.g. Data2- and Data2+). It’s caused by different wire lengths or slightly different wire construction (impedance mismatch) in DVI cable. It results in jitter.

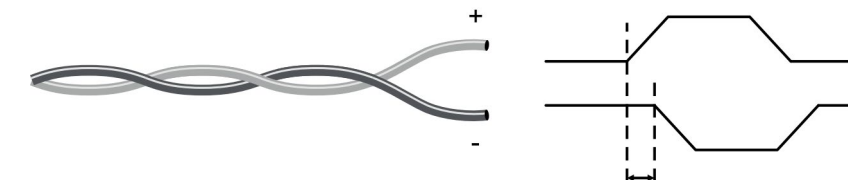

### Inter-pair skew

Skew between two differential wire pairs in a cable. It is caused by different wire pair lengths or different number of twists in the DVI cable. Too much inter-pair skew results color shift in the picture or sync loss.

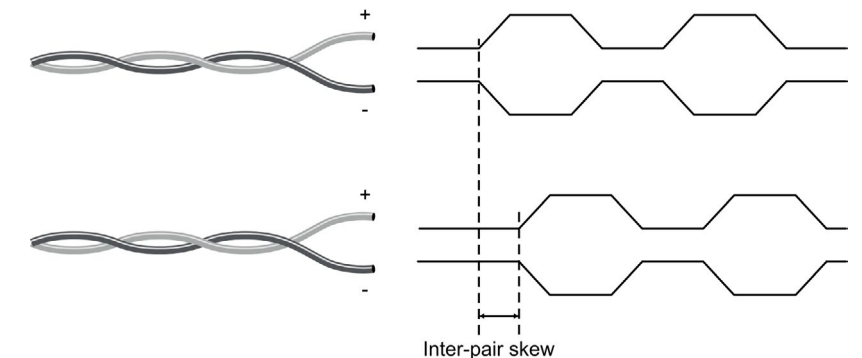

**Jitter**

Signal instability in the time domain. The time difference between two signal transitions should be a fixed value, but noise and other effects cause variations.

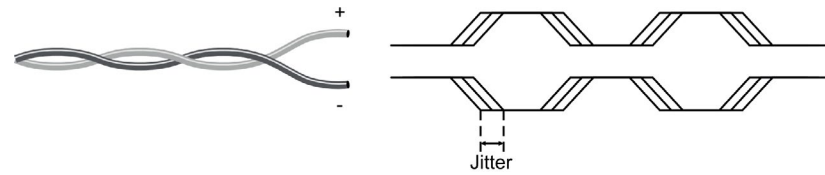

**Noise**

Electromagnetic interference between other electronic devices such as mobile phones, motors, etc. and the DVI cable are coupled onto the signal. Too much noise results in increased jitter.

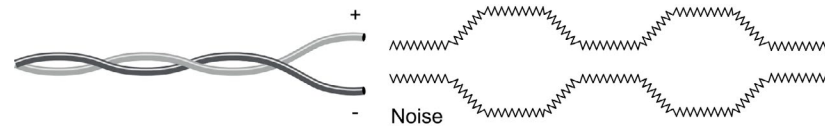

**10.4. Dual-Link DVI signal**

The Dual-Link DVI interface can operate in either Single-Link or Dual-Link mode. The chosen mode depends on the pixel clock frequency of the signal and it is selected by the hardware automatically. For pixel clock frequencies lower than 165 MHz, Single-Link mode is selected. For higher pixel clock frequencies (up to 330 MHz), Dual-Link mode is selected. It is important to know that pixel clock frequency is not the same as TMDS clock frequency when it comes to Dual-Link DVI.

The pixel clock frequency in Single-Link transmission is a 10th part of the data rate. The maximum data rate of the Single-Link transmission is 1.65 Gbps per TMDS channel and the maximum pixel clock frequency is 165 MHz. In this case the pixel clock frequency equals the TMDS clock frequency. The pixel clock frequency in Dual-Link transmission (when in Dual-Link mode) is a 5th part of the data rate. The maximum data rate of Dual-Link transmission is still 1.65 Gbps per TMDS channel but the maximum pixel clock frequency is 330 MHz. In this case the pixel clock frequency is two times the TMDS clock frequency.

The DVI standard maximizes the data rate of the TMDS channels in 1.65 Gbps. Dual-Link DVI interface enables a higher resolution compared to the Single-Link transmission by doubling the number of wire pairs to transmit the video signal. In Single-Link cables 3 wire pairs carry the color information (red, green and blue) and one wire pair carries the clock signal (TMDS clock).

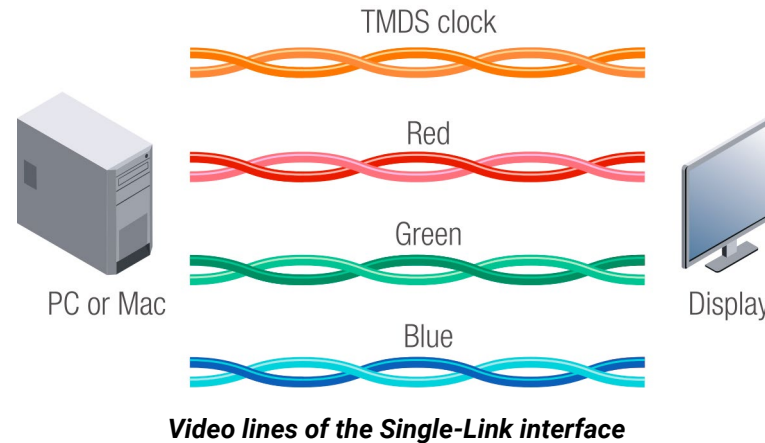

In Dual-Link cables, 6 wire pairs carry the color information next to the TMDS clock signal. One color component is carried by two wire pairs, where one wire pair carries the odd pixels and the other wire pair carries the even pixels.

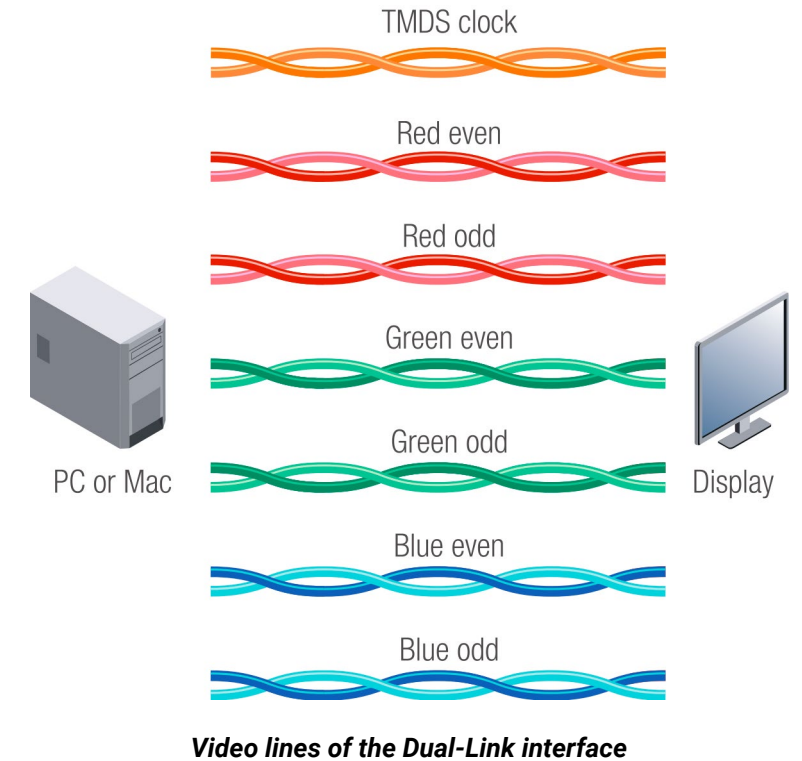

**INFO:** The colors of the wire pairs in the picture represent the color information they carry and not the color of the actual wires inside the cable.



### 10.5. RS-232 Command Transmission

Lightware Hybrid Modular Matrix system provides bidirectional RS-232 signal transmission at remote endpoints. The feature is implemented on certain boards like .... transmitters and receivers. The desired third-party device can send and receive commands directly to/from the far endpoints. No additional cable is required as the commands are sent through the cable (fiber, TPS) that is connected to the I/O board in the matrix.

Lightware Hybrid Modular Matrix system provides easy interfacing of RS-232 control commands for devices at remote endpoints through bidirectional RS-232 ports on the matrix I/O boards (MX-HDMI-OPT-IB, MX-HDMI-OPT-OB, and MX-TPS-IB, MX-TPS-OB), transmitters and receivers. The desired application (e.g. control system, touch screen) sends and receives short RS-232 control commands directly from the far endpoints. The commands are sent out directly from the far endpoints independently on each optical or TPS port over the same fiber or CATx cable, used by the video/audio transmission so that no additional cable is required for system control.

#### Home Cinema Application

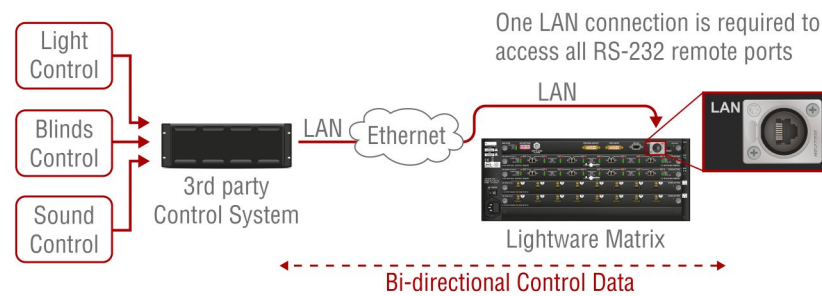

The RS-232 control command is transmitted from the touch control to the projector through the matrix and the receiver on a single fiber which also transmits the video and audio. The touch screen can control the matrix as well to perform crosspoint-switching or change settings in the frame.

#### Conference Room Application

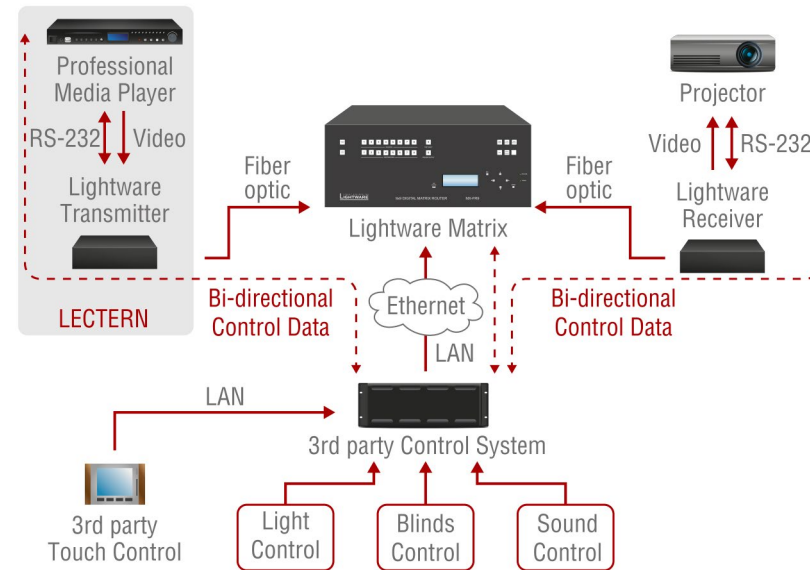

Both professional sources and displays can be controlled through the AV network. The touch screen control sends a "presentation starting" command to the control system, which adjusts the lighting and shutters, turns on the projector and switches the crosspoint's output to the lectern laptop.

#### Control System Connection

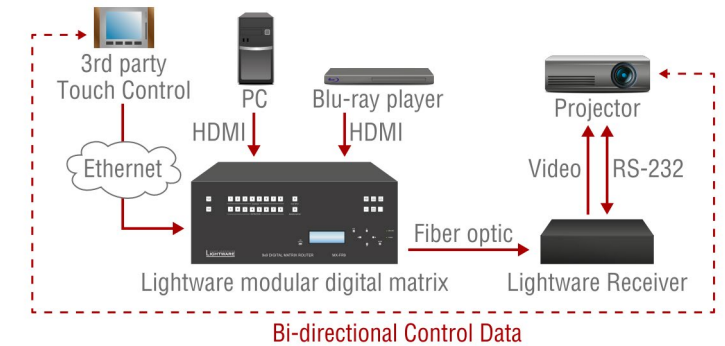

The third-party control system is connected to the Lightware crosspoint via a LAN connection to access all RS-232 remote ports. Control commands can only be sent to and received from the matrix on the LAN connection by the control system.

The baud rate can be 9600, 19200, 36800, 57600. There is a stop bit and no parity bit covering all consumer devices on the market to be suitable for the communication. The control protocol has two different methods for sending and receiving RS-232 data from or to the frame: ASCII mode could be used only with human readable characters while binary mode can handle any data.

Maximum 54-byte data can be sent / received at once, e.g. it is not possible to transfer files or to do a firmware upgrade via the router. It is also important, that the control interfaces on the router (USB, IP, and RS-232) use a shared resource. Please ensure that across all connections no more than 8 unanswered queries are in progress. If proper locking can not be implemented, waiting for 600 ms between each query on each connections is generally sufficient.

## 10.6. The RICOD Technology

### 10.6.1. Introduction

The main goal of Remote Input Control Over DDC (RICOD) is to control the remote Lightware transmitters attached to a router (local device). The control means input switching (select video and audio sources) and locking / unlocking the remote buttons / switches.

**ATTENTION!** There is no possibility to send other kind of commands, including Lightware protocol commands or any other character sequence. The "RS-232 extension" function is out of the question.

**ATTENTION!** RICOD is Lightware's intellectual property and proprietary function. It works only with Lightware devices.

### 10.6.2. Operation

#### Master and Slave Modes

First of all, it is important to understand the direction of RICOD and the working modes. Lightware's RICOD-capable devices are able to send out remote switching commands on their video inputs towards another RICOD capable devices' video output and / or they can receive remote switching commands on their video outputs from another RICOD capable devices' video input. One device can work as a Master or a Slave:

#### Master

If a device sends out RICOD commands over its video input it works as a Master, like the device on the right side. Lightware matrix routers (e.g. MX-FR frames with CPU2) work as RICOD Masters typically.

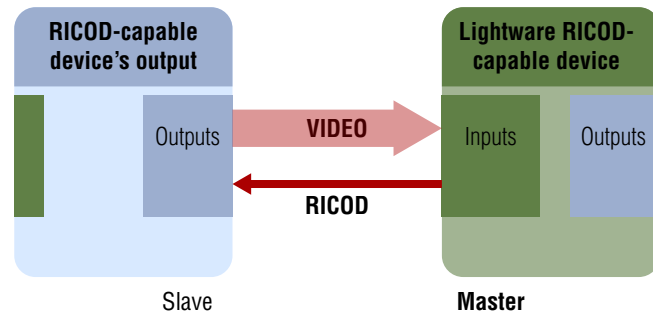

#### Slave

If a device receives RICOD commands over its video outputs it works as a Slave, like the device on the left side. In this case, the devices are capable of receiving commands over their outputs (e.g. connected to another Lightware device) if the function is enabled.

This means that the remote device is capable of being controlled from that given output. (The command affects only that output where the RICOD command was received). The Lightware transmitters (e.g. WP-UMX-TP-TX100) work as RICOD Slaves typically.

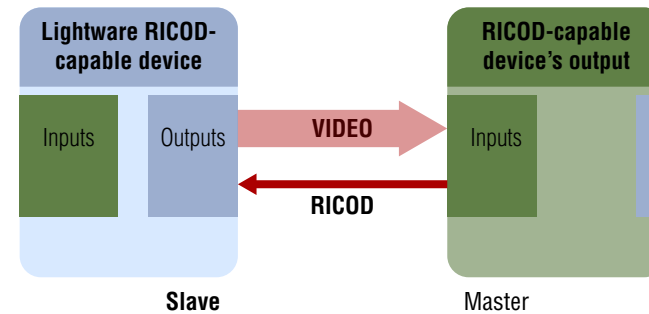

#### Factory Defaults

After a firmware upgrade the Slave mode is always enabled (commands from the Master devices are accepted and executed) and the Master mode is always disabled. That state is reloaded when factory default settings are restored by protocol command (FACTORY=ALL). For more information about reloading the factory defaults see the user's manual of the devices.

### 10.6.3. Enable / Disable RICOD

Users can enable or disable the RICOD function for each input and output video port separately. For example, one can enable the RICOD on the 1st and the 2nd video input and the 1st and the 3rd video output port. RICOD is disabled on the other video input and output ports; below figure shows this case. Video ports where RICOD is enabled are green.

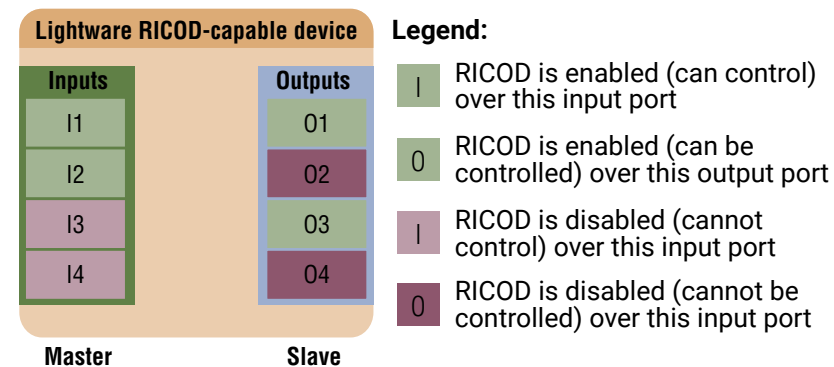

The RICOD can be enabled or disabled by LW2 protocol commands for every Lightware device. (For more information see the [RICOD Related Commands](#) section.)

### 10.6.4. Validity of RICOD

The last command will be saved for each input and will be preserved until a new command arrives or until the function is disabled. If the remote controlled device is restarted, replaced or disconnected and connected again, then the command will be executed again. The command will take effect even if the local device (e.g. the MX-FR matrix with CPU2) is restarted or the function is enabled again.

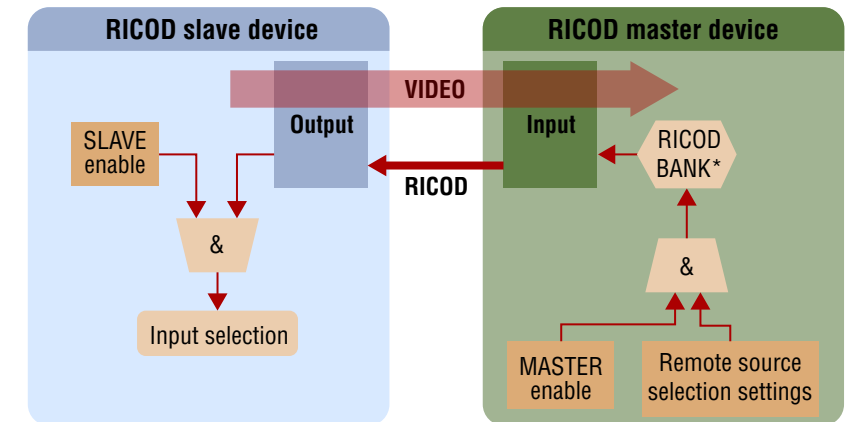

**INFO:** The communication between the devices is uni-directional, so there is no feedback from the remote controlled device.

### 10.6.5. Locking the Remote Device

The intention of this feature is to prevent accidental or unwanted switching when the remote device is installed near to the end-users. The remote device can be locked by the local device via a RICOD command. The behavior is different for the video routers and for the extenders:

#### Extenders

If an extender (e.g. WP-UMX-TP-TX100) receives a lock command by the RICOD function, then it will disable the front panel switching buttons. The buttons are disabled until the device is disconnected (connection is detected by the Hotplug detect signal – which is carried by the DDC CAT cable when using CATx extenders) or the remote lock command is cleared by the local device. This can be done by turning off the RICOD function or by turning off only the lock command.

If a new device is connected which does not support RICOD commands then the remote lock will be disabled.

Note that when the buttons are disabled, then they do not react at all – switching and unlocking are also impossible.

The transmitters are still able to receive and execute commands via their local control interface (e.g. RS232 or USB) while RICOD lock is enabled. The remote lock command affects only the buttons but does not prevent the switching if it is commanded locally.

#### Locking Operation Flowchart

Buttons on the extenders can be locked by front panel operation or remotely, but the two ways of locking are not the same. If buttons were locked by a front panel operation, they can be unlocked by a RICOD unlock command followed by an unlock operation on the front panel.

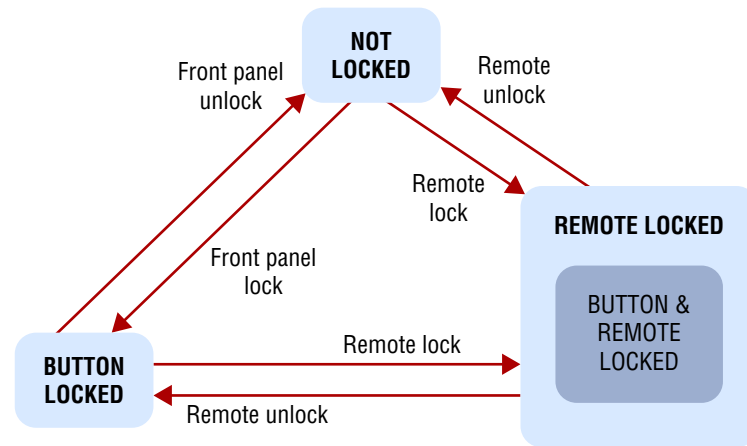

#### Video Routers

The routers behave differently because locking the whole front panel is not reasonable. When the RICOD function is enabled for an output port (see RICOD\_SLEN command in the [Querying the RICOD SLAVE Status](#) section) and a lock command is received over the same port, then the output port will be "output locked". This is the same output lock function as described in the [Output Lock](#) section. The output lock is reported back by the protocol (shown in the controller software and on the web, as well) and displayed on the front panel. The output lock can be overridden and turned off by protocol or front panel.

If the output lock is enabled for a given port, a remote RICOD command is also able to turn it off.

**ATTENTION!** The accepted RICOD command overrides the output lock function. If the RICOD function is turned on for a given output port, then the output lock condition can be changed remotely.

#### 10.6.6. RICOD-Capable Devices

The RICOD functionality is currently implemented in the following devices:

- MX-FR frames with CPU2, firmware version 3.3.5r and above.
- UMX4x4 Pro, firmware version 1.2.4r and above.
- UMX-TP-TX100R, firmware version 1.1.6r and above.
- WP-UMX-TP-TX100, firmware version 1.1.0r and above.
- FP-UMX-TP-TX100, firmware version 1.1.0r and above.

\* The MX-FR series modular matrix frames with MX-CPU2 processor boards (with firmware version 3.3.5r and above) support reduced RICOD capabilities: only MASTER mode is available and only by protocol commands. RICOD SLAVE mode and the front panel operation are not implemented.

# 11

## Appendix

- ▶ SPECIFICATIONS
- ▶ FACTORY DEFAULT SETTINGS
- ▶ MAXIMUM CABLE LENGTHS (TPS AND TPS2 BOARDS)
- ▶ MAXIMUM CABLE LENGTHS (TP BOARDS)
- ▶ FACTORY EDID LIST
- ▶ CABLE WIRING GUIDE
- ▶ FIRMWARE RELEASE NOTES
- ▶ MECHANICAL DRAWINGS
- ▶ ASCII TABLE
- ▶ HASHTAG KEYWORD LIST
- ▶ FURTHER INFORMATION

### 11.1. Specifications

#### 11.1.1. General

Compliance .....	CE
EMI/EMC .....	EN 55035:2017, EN 55032:2015
Safety .....	EN 62368-1:2014
Warranty .....	3 years
Operating temperature .....	0°C ~ +50°C
Humidity .....	10 ~ 90% RH
Power source .....	100-240 V AC; 50~60 Hz

#### 11.1.2. Matrix Frames

##### MX-FR80R and MX-FR65R

Power consumption.....	max 2000 W (6830 BTU/hour)
Power supply unit(s) type.....	FNP850-12RG
Rack mount .....	Yes, 15U high
Dimensions (mm) .....	W482 x D393 x H665
Dimensions (inch).....	W19.0 x D15.5 x H26.2
Weight (with MX-CPU2 board) .....	27.6 kg
MX-PSU-850 .....	1.4 kg

##### MX-FR33R

Power consumption .....	max 320 W (1092 BTU/hour)
Rack mount .....	Yes, 7U high
Dimensions (mm) .....	W482 x D400 x H309
Dimensions (inch).....	W19.0 x D15.7 x H12.1
Weight (with MX-CPU2 board) .....	33.9 kg
MX-PSU-350 .....	1 kg

##### MX-FR33L

Power consumption .....	max 250 W (854 BTU/hour)
Rack mount .....	Yes, 6U high
Dimensions (mm) .....	W482 x D300 x H265
Dimensions (inch).....	W19.0 x D15.7 x H10.4
Weight (with MX-CPU2 board) .....	11.6 kg

Applied CPU2 firmware: v3.5.7b8 | LDC software: v1.33.2b1

#### MX-FR17, MX-FR9

Power consumption .....	max 160 W (546 BTU/hour)
Rack mount .....	Yes, 4U high
Dimensions (mm) .....	W482 x D300 x H176
Dimensions (inch).....	W19.0 x D11.8 x H6.9
Weight (with MX-CPU2 board) .....	10.8 kg

#### MX-FR17R, MX-FR9R

Power consumption (per PSU).....	max 350 W (1194 BTU/hour)
Rack mount .....	Yes, 4U high
Dimensions (mm) .....	W482 x D300 x H176
Dimensions (inch).....	W19.0 x D11.8 x H6.9
Weight (with MX-CPU2 board) .....	11.7 kg

#### 11.1.3. I/O ports

##### Inputs (MX-CPU2)

Connectors .....	29-pole DVI-I digital only
Input cable equalization .....	No
EDID emulation .....	Yes
Reclocking.....	Yes, Pixel Accurate Reclocking

##### Outputs (MX-CPU2)

Connectors .....	29 pole DVI-I digital only
Output pre-emphasis .....	No
Reclocking.....	Yes, Pixel Accurate Reclocking
EDID read .....	Yes
+5V output current.....	500 mA continuous each (protected)

##### Signal

Data rate: .....	all between 25 Mbps and 2.25 Gbps / TMDS channel
Channels: .....	1x TMDS Clock + 3x TMDS Colors
Resolutions: .....	all between 640x480 and 1920x1200@60Hz or 2048x1080@60Hz
Color depth: .....	maximum 36 bits, 12 bit/color



Color format ..... RGB, YCbCr 4:4:4  
 HDTV resolutions: ..... 720p, 1080i, 1080p  
 HDMI 1.3a compatible: ..... Yes (embedded audio)  
 HDCP compliant: ..... Yes

**Control**

Front Panel buttons ..... Yes  
 Serial port connector ..... 9 pole D-SUB female RS-232 or RS-422  
 Baud rate ..... 57600 Baud, 8 bit, 1stop bit, no parity  
 Ethernet port connector ..... EtherCON, RJ45 female connector  
 Ethernet protocol ..... TCP/IP, HTTP, TFTP, Telnet  
 IP address assignment..... fixed, DHCP, BOOTP, and AutoIP  
 Alarm output connector ..... SMPTE 269M standard BNC  
 Weight.....0.9 kg

**Control over Fiber and TPS**

Selectable baud rate ..... Yes  
 Baud rate ..... 9600, 19200, 36800, 57600  
 Sent/received data throughput ..... Maximum 54 byte  
 Maximum bandwidth ..... 57600 bit/sec\*

\* (RS-232, IP and USB control altogether)

**11.2. Factory Default Settings**

Network Settings	
IP address	192.168.254.254
Subnet mask	255.255.0.0
Static gateway	0.0.0.0
DHCP	Disabled
LW2 Port number	10001
HTTP Port number	80
Control protocol	LW2
Video Port Settings	
Crosspoint state	I1 input port on all output ports
Input/Output ports	Unmuted, Unlocked
Emulated EDID (input ports)	F49 – Universal HDMI EDID
EDID memory	Empty (User and Dynamic EDIDs)
Crosspoint presets	All outputs to I1
Preset names	Preset1, Preset2,...
Port names	Input1, Input2...; Output1, Output2...
RS-232 Settings	
Baud rate	57600
Databits	8
Parity	No
Stopbits	1
Control protocol	LW2

**11.3. Maximum Cable Lengths (TPS and TPS2 Boards)**

Resolution	Pixel Clock Rate [MHz]	Cable Lengths (Auto / Longreach TPS Mode)		
		CAT5e AWG24	CAT7 AWG26**	CAT7 AWG23
1024x768@60Hz	65	100 m / 130 m*	90 m / 120 m*	120 m / 170 m*
1280x720p@60Hz	73.8	100 m / 130 m*	90 m / 120 m*	120 m / 170 m*
1920x1080p@60Hz / 24bpp	148.5	100 m / 130 m*	90 m / 120 m*	120 m / 170 m*
1920x1200@60Hz	152.9	100 m / NA	90 m / NA	120 m / NA
1600x1200@60Hz	162	100 m / NA	90 m / NA	120 m / NA
1920x1080@60Hz / 36bpp	223.6	70 m / NA	70 m / NA	100 m / NA
3840x2160@30Hz UHD	297	70 m / NA	70 m / NA	100 m / NA
4096x2160@30Hz 4K	297	70 m / NA	70 m / NA	100 m / NA

\* With Long reach operation mode which supports pixel clock frequencies up to 148.5 MHz.

\*\* When remote powering is used with AWG26 cables, distances are 20% shorter.

To specify the accurate extension distances, please also check the documentation of the connected HDBaseT-compatible device.

**11.4. Maximum Cable Lengths (TP Boards)**

Resolution	CAT5e UTP	CAT5e FTP	CAT6 UTP	CAT6 FTP	CAT6 SFTP	CAT7 SFTP
640x480@60	60 m	60 m	65 m	70 m	70 m	80 m
800x600@60	60 m	60 m	65 m	65 m	65 m	75 m
1024x768@60	55 m	55 m	60 m	60 m	60 m	75 m
1280x720p60	55 m	55 m	60 m	60 m	60 m	70 m
1280x1024@60	50 m	50 m	55 m	60 m	60 m	65 m
1400x1050@60	45 m	45 m	45 m	55 m	55 m	60 m
1600x1200@60	30 m	35 m	35 m	45 m	45 m	50 m
1920x1080p60	30 m	35 m	35 m	45 m	45 m	50 m
1920x1200p60	30 m	35 m	35 m	45 m	45 m	50 m

### 11.5. Factory EDID List

Mem.	Resolution			Type
F1	640 x	480p	@ 60.0 Hz	D
F2	848 x	480p	@ 60.0 Hz	D
F3	800 x	600p	@ 60.30 Hz	D
F4	1024 x	768p	@ 60.0 Hz	D
F5	1280 x	768p	@ 50.0 Hz	D
F6	1280 x	768p	@ 59.92 Hz	D
F7	1280 x	768p	@ 75.0 Hz	D
F8	1360 x	768p	@ 60.1 Hz	D
F9	1280 x	1024p	@ 50.0 Hz	D
F10	1280 x	1024p	@ 60.1 Hz	D
F11	1280 x	1024p	@ 75.1 Hz	D
F12	1400 x	1050p	@ 49.99 Hz	D
F13	1400 x	1050p	@ 59.99 Hz	D
F14	1400 x	1050p	@ 75.0 Hz	D
F15	1680 x	1050p	@ 59.99 Hz	D
F16	1920 x	1080p	@ 50.0 Hz	D
F17	1920 x	1080p	@ 60.0 Hz	D
F18	2048 x	1080p	@ 50.0 Hz	D
F19	2048 x	1080p	@ 59.99 Hz	D
F20	1600 x	1200p	@ 50.0 Hz	D
F21	1600 x	1200p	@ 60.0 Hz	D
F22	1920 x	1200p	@ 50.0 Hz	D
F23	1920 x	1200p	@ 59.55 Hz	D
F24	2048 x	1200p	@ 59.95 Hz	D
F29	<b>Universal DVI EDID</b>			U
F30	1440 x	480i	@ 60.3 Hz	H
F31	1440 x	576i	@ 50.6 Hz	H
F32	640 x	480p	@ 59.94 Hz	H
F33	720 x	480p	@ 59.92 Hz	H
F34	720 x	576p	@ 50.0 Hz	H

Mem.	Resolution			Type
F35	1280 x	720p	@ 50.0 Hz	H
F36	1280 x	720p	@ 60.0 Hz	H
F37	1920 x	1080i	@ 50.3 Hz	H
F38	1920 x	1080i	@ 50.0 Hz	H
F39	1920 x	1080i	@ 59.98 Hz	H
F40	1920 x	1080i	@ 60.5 Hz	H
F41	1920 x	1080p	@ 24.0 Hz	H
F42	1920 x	1080p	@ 24.99 Hz	H
F43	1920 x	1080p	@ 30.0 Hz	H
F44	1920 x	1080p	@ 50.0 Hz	H
F45	1920 x	1080p	@ 59.93 Hz	H
F46	1920 x	1080p	@ 60.0 Hz	H
F47	<b>Universal HDMI EDID, PCM audio</b>			U
F48	<b>Universal HDMI EDID, all audio</b>			U
F49	<b>Univ. HDMI EDID, all aud, deep c.</b>			U
F50	720 x	480i	@ 30.1 Hz	A
F51	720 x	576i	@ 25.3 Hz	A
F52	640 x	480p	@ 60.0 Hz	A
F53	640 x	480	@ 75.0 Hz	A
F54	800 x	600	@ 50.0 Hz	A
F55	800 x	600	@ 60.30 Hz	A
F56	800 x	600	@ 74.99 Hz	A
F57	1024 x	768	@ 49.98 Hz	A
F58	1024 x	768	@ 60.0 Hz	A
F59	1024 x	768	@ 75.2 Hz	A
F60	1280 x	768	@ 50.0 Hz	A
F61	1280 x	768	@ 59.92 Hz	A
F62	1280 x	768	@ 75.0 Hz	A
F63	1360 x	768	@ 60.1 Hz	A
F64	1364 x	768	@ 50.0 Hz	A

Mem.	Resolution			Type
F65	1364 x	768	@ 59.93 Hz	A
F66	1364 x	768	@ 74.98 Hz	A
F67	1280 x	1024	@ 50.0 Hz	A
F68	1280 x	1024	@ 60.1 Hz	A
F69	1366 x	1024	@ 59.99 Hz	A
F70	1400 x	1050	@ 49.99 Hz	A
F71	1400 x	1050	@ 59.99 Hz	A
F72	1400 x	1050	@ 75.0 Hz	A
F73	1920 x	1080i	@ 50.0 Hz	A
F74	1920 x	1080i	@ 59.98 Hz	A
F75	1920 x	1080	@ 50.0 Hz	A
F76	1920 x	1080	@ 60.0 Hz	A
F77	1600 x	1200	@ 50.0 Hz	A
F78	1600 x	1200	@ 60.0 Hz	A
F79	1920 x	1200	@ 59.55 Hz	A
F80	1920 x	1200	@ 50.0 Hz	A
F89	<b>Universal Analog EDID</b>			U
F90	1920 x	2160	@ 59.98 Hz	D
F91	1024 x	2400	@ 60.1 Hz	D
F92	1920 x	2400	@ 59.97 Hz	D
F93	2048 x	2400	@ 59.97 Hz	D
F94	2048 x	1536	@ 59.99 Hz	D
F95	2048 x	1536	@ 74.99 Hz	D
F96	2560 x	1600	@ 59.85 Hz	D
F97	3840 x	2400	@ 23.99 Hz	D
F98	1280 x	720p	@ 60.0 Hz	3D
F99	1920 x	1080p	@ 60.0 Hz	3D
F100	1024 x	768p	@ 60.0 Hz	H
F101	1280 x	1024p	@ 50.0 Hz	H
F102	1280 x	1024p	@ 60.1 Hz	H

Mem.	Resolution			Type
F103	1280 x	1024p	@ 75.1 Hz	H
F104	1600 x	1200p	@ 50.0 Hz	H
F105	1600 x	1200p	@ 60.0 Hz	H
F106	1920 x	1200p	@ 59.55 Hz	H
F107	2560 x	1440p	@ 59.94 Hz	H
F108	2560 x	1600p	@ 59.85 Hz	H
F109	3840 x	2400p	@ 23.99 Hz	H
F110	3840 x	2160p	@ 24.0 Hz	H
F111	3840 x	2160p	@ 25.0 Hz	H
F112	3840 x	2160p	@ 30.0 Hz	H
F113	3840 x	2160p	@ 60.0 Hz	4:2:0
F118	<b>Universal 4K EDID, PCM audio</b>			U
F119	<b>Universal 4K EDID, all audio</b>			U

**Legend**

- D: DVI EDID
- H: HDMI EDID
- 3D: HDMI EDID with 3D support
- 4:2:0: EDID with color depth conversion to 4:2:0
- U: Universal EDID (supporting many common resolutions)

Please note that minor changes in the factory EDID list may be applied in next firmware versions.

## 11.6. Cable Wiring Guide

Inputs and outputs of audio devices are symmetric or asymmetric. The main advantage of the symmetric lines is the better protection against the noise therefore, they are widely used in the professional audio industry. Symmetric audio is most often referred to as balanced audio, as opposed to asymmetric, which is referred to as unbalanced audio. Lighthouse products are usually built with 5-pole Phoenix connectors so we would like to help users assembling their own audio cables. See the most common cases below.

**ATTENTION!** Symmetric and asymmetric lines can be linked with passive accessories (e.g. special cables), but in this case half of the line level is lost.

**ATTENTION!** There are numerous types of regularly used connector and cable types to connect audio devices. Please always make sure that a connector or cable fits your system before use.

**ATTENTION!** Never join the phase-inverted (negative, cold or -) poles (either right and left) to the ground or to each other on the output side, as this can damage the unit.

**INFO:** Use a galvanic isolation in case of a ground loop.

### The Pinout of the 5-pole Phoenix Connector

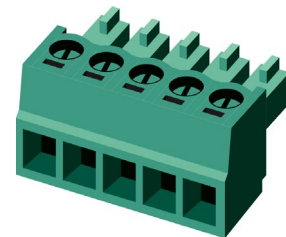
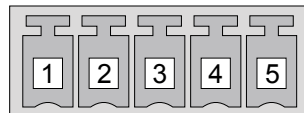

Pin nr.	Signal
1	Left+
2	Left-
3	Ground
4	Right-
5	Right+

### Compatible Plug Type

Phoenix® Combicon series (3.5mm pitch, 5-pole), type: MC 1.5/5-ST-3.5.

### From Unbalanced Output to Balanced Input

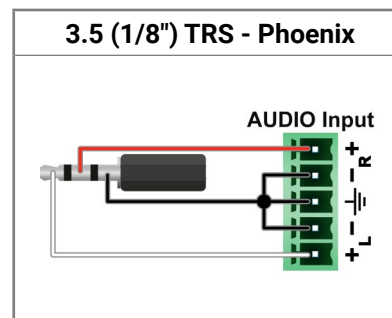
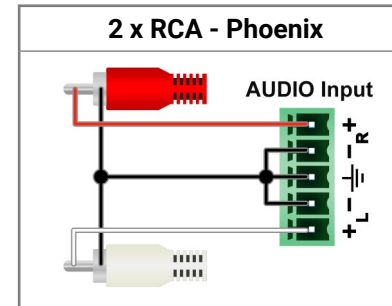
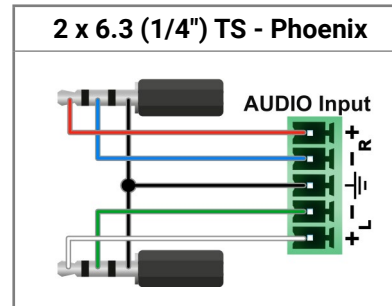

### From Balanced Output to Balanced Input

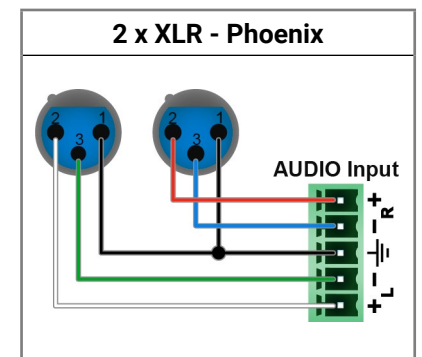
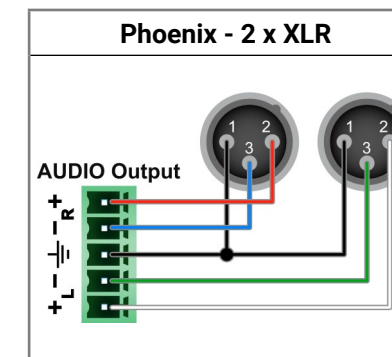
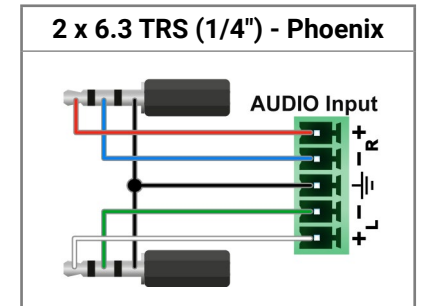
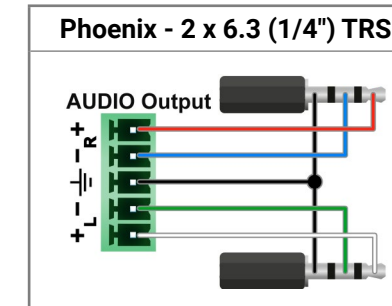

### From Balanced Output to Unbalanced Input

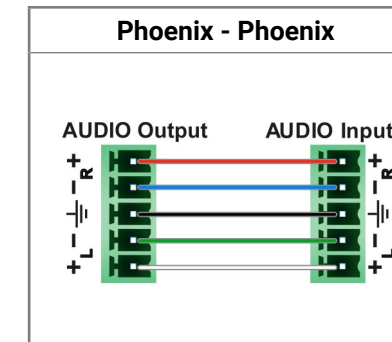
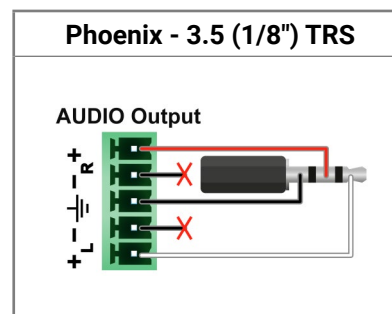
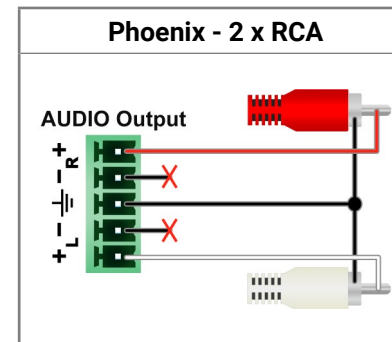
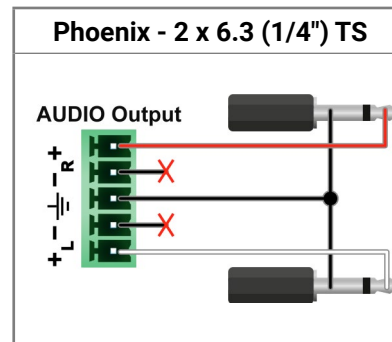

## 11.7. Firmware Release Notes

Below list shows the released firmware packages with important notes.

### 3.0.0

Released: 2010-07-14

#### New feature

- MX-FR16 support
- MX-FR80 support
- MX-DVID-IB, MX-DVID-OB support
- MX-DVI-TP-IB, MX-DVI-TP-OB support
- MX-DVI-TP-IB+, MX-DVI-TP-OB+ support
- MX-OPT-DVI-OB, MX-OPT-DVI-OB-RCLK support (including SX4A and SX4B optical modules)
- PLL filter is enabled as default in the SI164 chip
- Implements a test input and a preview output port on the CPU card
- SMPTE alarm function
- Advanced EDID management, HDMI support is automatically stripped if needed
- LCD menu, control board
- Date and time functions
- Log errors and basic configuration to the onboard microSD card (FAT filesystem, accessible via Lightware protocol).
- Monitoring the voltages, fan speeds and power supplies
- PROTOCOL#2 support
- Standby mode

### 3.0.1

Released: 2010-09-16

#### New feature

- MX-FR32R support
- Extended reliability, watchdog + task autorestart
- MX-HDMI-IB, MX-HDMI-OB support (including audio support)
- MX-DVI-HDCP-IB, MX-DVI-HDCP-OB support
- MX-OPT-DVI-IB support
- MX-DVIDL-IB, MX-DVIDL-OB support

- HDCP is supported by crosspoint level (HDCP protected signal is routed only to compatible output boards, so mixed cards are supported).
- HDMI and HDCP support on preview out and test in
- DualLink signals are supported by crosspoint level (mixed cards are supported).
- HDCP repeater function support
- MX-DVI-CPU SCH 2.2 support
- Extended protocol command set (E.g. diagonal switching)

#### Bugfix

- Monitor task dies eventually (very rare). It restarts automatically, so causes no visible problem.
- Sometimes there is no response to a command (extremely rare).

### 3.0.11

Released: 2011-04-06

#### New feature

- TIPO (Test Input / Preview Output) menu is implemented on the LCD.

#### Bugfix

- False fanspeed error bugfix
- MX-DVI-OPT-OB bugfixes (programming TOSA modules is more robust now.)
- Controllock button blinking issue bugfix, autotake bugfixes
- PRECONF TOSA, ROSA commands bugfix
- Protocol#2 mode freezed when invalid characters were sent.
- 4-line LCD EDID switch issue bugfix
- Automatic EDID refresh on LCD
- Preset didn't save the mute state.
- AD xpoint switching speed up

### 3.0.3

Released: 2012-12-22

#### New feature

- LCD menu improvements
- MX-DVII-HDCP-IB support

- Dual protocol mode. (In Protocol#1 mode Protocol#2 commands are also accepted.)
- MX-DVID-OB SCH 1.1 support

#### Bugfix

- Lantronix reset bugfix
- Preview output HDMI mode is possible now.

### 3.0.4

Released: 2010-12-23

#### Bugfix

- Minor MX-DVII-HDCP-IB bugfixes and improvements

### 3.0.5

Released: 2010-01-24

#### New feature

- Recognising analog video formats by VESA GTF and CVT for MX-DVII-HDCP-IB
- 4-line LCD menu support
- ELIST command is added. ( Front LCD error list - errors since the last boot-up - is copied.)
- USB support is added.

#### Bugfix

- Xpoint factory default
- CP panel LED blinking bugfix
- Preview output lock and mute bugfix
- Lantronix communication bugfix

### 3.0.6

Released: 2011-01-31

#### New feature

- Coordinated Video Timings, Reduced Blanking support for MX-DVII-HDCP-IB
- 4-line LCD menu improvements
- Bugfix
- Power sum read-out is more redundant.
- MX-DVII-HDCP-IB factory presets search bugfix

### 3.0.7



Released: 2011-02-03

#### New feature

- HDCP keycounter menu on the LCD

#### Bugfix

- MX-DVID-OB port 8 - Vista Spyder incompatibility bugfix.

### 3.0.8

Released: 2011-02-24

#### Bugfix

- Protocol#2 bugfixes (mute and lock)
- MX-HDMI-OPT-OB LED blinking bugfix

### 3.0.9

Released: 2011-03-07

#### New feature

- :EQ command syntax is more universal: 0 is accepted as auto EQ if discrete eq is used.

#### Bugfix

- False fanspeed error bugfix
- MX-DVI-OPT-OB bugfixes (programming TOSA modules is more robust now.)

### 3.1.0

Released: 2011-05-09

#### New feature

- MXD-HDMI-TP-OB support
- Newer version of the FAT filesystem library - it is more robust.
- Input 0 can be connected to anywhere (same as mute).
- Temperature measurement and show (calibration is needed).
- DVID-OB signal on/off setting is removed.

#### Bugfix

- MX-DVI-OPT-IB, -OB PS (port status) command bugfix
- FR32 health status format has been changed.
- MX-DVID-OB CTL3 issue (barco projector compatibility)

### 3.1.1

Released: 2011-05-24

#### New feature

- Error message appears on the LCD in control lock mode if a key is pressed

#### Bugfix

- TIPO menu had sometimes shown in FR80 Frame on the LCD.
- Control Board freezed sometimes. (CB p:14 error)
- The frame works without MX-SC (LCD panel) now.
- Front panel take button -input button 1 problem bugfix
- TIPO menu usage has been improved.
- MX-DVI-OPT-OB-RCLK LCD menu PLL filter settings is implemented on the 4-line LCD.
- DVI-I board sent DVI signal in auto mode if a MX-DVI-HDCP-OB, MX-HDMI-OB or MX-HDMI-TP-OB was present.
- Preview output, MX-HDMI-OB, MX-HDMI-TP-OB, MX-DVI-HDCP-OB, MXD-HDMI-TP-OB outputs discarded audio if the sink device had been connected later than the audio content had been switched to the output.
- Analog formats signalled in the emulated EDIDs were sometimes detected incorrectly.

### 3.1.2

Released: 2011-06-08

#### New feature

- MXD-UMX-IB support
- MX-DVIDL-OPT-IB support
- MX-DVIDL-OPT-OB support

#### Bugfix

- If a single-link input was connected to a dual link output then the 2nd link wasn't shut down in AUTO mode.
- MX-DVI-OPT-OB 2.2 and 2.3 could cause erroneous initialization in some slots.
- 4-line LCD HDCP keycounter had false fail.
- Countermeasure against 4-line LCD sensitivity to electrostatic discharge events. (First part of the content is read back and checked regularly, in case of discrepancy the content is refreshed.)

### 3.1.3

Released: 2011-07-20

#### New feature

- CARD ACTIVE LED doesn't flash on unknown or unrecognized IO cards in order to help error detection by customers.
- RS232, LAN and USB interfaces are independent - responses arrive to only the appropriate port, except crosspoint commands. Please refer Lightware-CM-1001 for details.
- RS232 and LAN interfaces can use different protocol at same time. Please see Lightware-CM-1001 for details.
- Responses to Protocol#2 switch commands are translated to Lightware protocol on the appropriate interfaces.
- Protocol setup from LCD menu.
- "Protocol reset" in Factory reset LCD menu - it restores Lightware protocol on RS232 and LAN.
- "Set all default" in Factory reset LCD menu - it resets all settings and deletes every change except files on SD card.
- Improved batch command processing speed if multiple switch commands are sent at the same time.
- MXD-AUDIO-IB volume handling is modified. The volume can be adjusted/reported between 0-6300 and 0-7800 in 0.01dB steps.
- Added 3D support for MX-HDMI-IB, MX-DVI-HDCP-IB, MX-HDMI-TP-IB, MX-CPU2 test input and preview output, MX-HDMI-OB, MX-DVI-HDCP-OB, MX-HDMI-TP-OB boards. The detected format is reported back in :HDMI command using the "reserved for future use" byte after colorspace. 1920x1080p, 1280x720p and 640x480p formats are supported in frame-packing, top-bottom, side-by-side mode.

#### Bugfix

- Protocol#2 switching commands didn't handle DL outputs at all.
- Commands were sometimes not recognized, there was no response (about every 10.000th switch).
- Preset load and Diagonal switch commands didn't consider DualLink ports.
- Protocol#2 commands were interpreted while using Protocol#1- now only Protocol#1 commands are accepted.
- Syntax error in a\*b% Protocol#2 command reply
- ISD and OSD responses didn't include the test input/preview output port.
- More than 32 preset could be saved in FR80R frame from front panel control board. Now it is only 32.
- CB issue: muted output button didn't blink when the source input button was pressed twice.

- DVI-I boards sometimes reported HDMI signals when DVI signal was present.
- MX-DVII-HDCP-IB board treated DVI signal as limited range colorspace. (Colors could be brighter/darker.) Now it is treated as full range - This involves only digital DVI signals.
- Preview output and HDCP output boards sometimes didn't detect the sent signal - especially with some formats and reversed VSYNC polarity.
- Downloading a long logfile on RS232 (especially with lower baudrates) or on LAN could cause a false TASK RESET error message.
- I2C speed has been reduced to 100 kHz during retrying the communication when NACK received from a SiI9134 or a SiI9135.
- MXD\_HDMI\_TP\_IB support.
- The default LCD menu page was the main menu structure on the 4-line LCD. Now it is the the Router Status page - similarly to the old 2-line display.
- PWR\_ON command didn't work in MX-FR80 frame after a PWR\_OFF command.
- I2C speed was reduced to achive more robustusness.
- SignalPresent and EDID menu problem in case of autotake mode has been solved.

### 3.1.4

Released: 2011-07-25

#### New feature

- Command {ST} now reports 'N/A' value instead of '0.00V' for the voltages that are not available in the FR80R frame.
- Complete status is saved to the SD card after the booting process if an error occurs.
- Timezones are supported (by adding UTC+nnnn to the end of the time, e.g. 22.07.2011. 15:33:52 UTC+0100)
- Changing time is logged to the SD card.
- Batch command processing for switch commands works on both Protocol#1 and Protocol#2.

#### Bugfix

- There is no E\_S\_C when a user EDID is uploaded.
- Front panel IP reset (ctr lock + output lock) works now
- MX-DVI-OPT-IB SCH\_2.2 laser powers weren't applied after boot.
- Buffer goes to invalid state in case of buffer overflow

- USB enumeration failed at boot cycle
- 'No card found' error is only a warning and not a fatal error.

### 3.1.6

Released: 2011-09-22

#### New feature

- Batch commanding applies wait for next command for faster execution.
- If a power supply looses AC then an error is generated. If it never had AC then no error is generated (only a warning).
- Error levels sent to communication interfaces can be configured independently to each port by a new command.
- RS232 baudrate can be adjusted from Lightware protocol by {RS232BAUD=.....} command.
- FACTORY=GENERAL command reloads the router default general settings (rs232 baudrate, take mode, control lock, communication protocols).

#### Bugfix

- 'PSU not seated/powered' warning is logged only once now.
- Timezone may have set to UTC+0256 after a firmware upgrade from earlier versions.
- The input buffers weren't flushed after a front-panel protocol switch. Earlier sent commands may have been executed. Now it is fixed.
- EDID switch on all inputs caused COMMTASK reset.
- HDMI LED remained ON when the source was disconnected. The problem occurred when the incoming signal was content protected and the input was switched to multiple output.
- MX-HDMI-TP-OB: there was no PSC event and the response for {PS} was all '0'
- 4line LCD didn't respond to menu button press in some cases.
- 4line LCD EDID switch menu showed '0' for the destination after startup and there was no 'ALL' option.
- Battery low voltage warning is logged (and displayed on the LCD) as 'BATTERY LOW' instead of 'VOLTAGE ALERT'.
- Some error log events were disappeared if the last error was too close in time.
- :HDCPPRESET command may have freezed the communication
- HDCP LED sometimes had false blinking on MX-HDMI-IB

- There was erroneous HDCP handling if more than 20 keys were received from an HDCP capable sink. This may have resulted reboot.

### 3.1.8

Released: 2011-09-30

#### New feature

- MX-DVI-OPT-OB v24 support.

#### Bugfix

- The response for {VM} command (View Mute state) now starts with "MUT" (not "ALL") according to the product manual.
- Matrix may have restarted because of internal communication problems in case of DVI-HDCP and HDMI I/O boards.

### 3.1.9

Released: 2011-10-10

#### Bugfix

- The response to the WB# command was different from the one described in the user manual. A number was missing at the end of the line.

### 3.2.0

Released: 2011-11-02

#### Bugfix

- In Protocol#2 the matrix did a switch to all for a single switch command. Now it's fixed.

### 3.2.2

Released: 2011-11-23

#### Bugfix

- Connecting an HDCP capable optical RX/TX to an MX-HDMI-OPT-IB/OB, noisy signal on the communication channel could cause fatal buffer overflow error and restarting of the router. In special cases the router could run an infinite restart loop.

### 3.2.3

Released: 2011-12-12

#### New feature

- Supports MX-3GSDI-IB.

### 3.2.5

Released: 2012-02-20

#### Bugfix

- New standard timing descriptors are applied. Standard resolution list now contains 1024x768@60 and 1920x1080@60 resolutions.
- Factory EDIDs had a bug - the digital sync was not set properly in the detailed timing descriptor blocks. Sometimes this caused error with analog sources.
- MX-DVI-OPT-OB 2.0 outputs flashed when a laser enable command was sent to any port.
- Preview output didn't convert down the deepcolor modes to HDMI 24bit in auto mode if the display didn't support deepcolor.
- An extra 0-byte length short descriptor was present in the CEA data block. This may have led to incompatibility with some sources.
- Analog 1920x1200p60 was not recognized due to enabled hsync dejitter filter and high sync detection threshold on the DVI-I board.
- ASUS EAH3650 video card can send a strange analog format in 1280x720p60 and 1920x1080p60. These resolutions are added to the factory preset list now.
- The 4-line LCD mismatched the 0dB and Auto EQ options in the MX-DVID-IB settings menu.
- On the 4 line LCD at the "Switch EDID" menu item it is possible to select factory and user EDIDs, not just dynamic EDIDs.
- Too many cached HDCP keys could lead to reboot.
- If an EDID switch happens while the source is reading the data, then the input board could fail (MX-HDMI-IB, MX-DVI-HDCP-IB, MX-HDMI-TP-IB)

#### 3.2.6

Released: 2012-03-01

#### New feature

- In case of FR33R the insertion and removal of the PSUs are logged.

#### Bugfix

- The matrix could fail to boot in case of wrong RTC.
- Invalid EDIDs cannot be switched to input ports anymore.
- The reply for {FC} command now contains the version of the FR33R PWR\_SUM board.
- HDCP handling of preview output in MX-FR80 didn't work properly.
- MX-HDMI-OPT-IB didn't detect if the link was terminated. (The bug appeared in 3.1.6)

#### 3.2.7

Released: 2012-05-30

#### New feature

- Support for MX-FR33L
- Pixel phase can be adjusted and saved with SMPTE compliant analog component/rgbhv incoming signals.
- Saving and loading of a full matrix config is now possible. It can be controlled with the LCD menu (2 and 4 line LCD) and the lightware protocol.
- Serial command passthru (receive and send) on MX-HDMI-OPT-IB/OB cards.
- Control commands are not uppercased any more. This way lowercase characters can be used for example with serial command passthru and I/O names. Control commands should be still recognized with lowercase or uppercase characters.

#### Bugfix

- Only the first two channels of multichannel PCM audio formats were passed by the router. Now up to 8 channels up to 192kHz are supported. Affected cards and ports: MX-HDMI-IB/OB, MX-DVI-HDCP-IB/OB, MX-HDMI-TP-IB/OB and CPU preview output/test input. When multichannel PCM is switched to an MX-HDMI-OB card, the front right and front left channels will be present on the SPDIF output connector.
- Audio infoframes were lost when the display was turned off and on again (or removed and plugged in again). Affected cards and ports: MX-HDMI-IB/OB, MX-DVI-HDCP-IB/OB, MX-HDMI-TP-IB/OB and CPU preview output/test input.
- SHUTDOWN time was invalid in some cases. now it's fixed.
- Some displays (only known example is DELLU2410) didn't play audio correctly, if the signal was originated from an MX-DVII-HDCP-IB or an MXD-UMX-IB board. The problem persisted at 148.5/1.001 and 74.25/1.001 pixel clock frequencies.
- The matrix rebooted after a while if a display continuously pulled the hot-plug up and down.

#### 3.2.8

Released: 2012-06-01

#### Bugfix

- In the MX-FR80R during the boot sequence the matrix reported a missing PSU as an error. It was a false alarm because it is an error only when the PSU is removed during operation. This false alarm is fixed.

#### 3.3.0

Released: 2012-08-16

#### New feature

- EDID reading is supported on both MX-HDMI-OPT-OB and MX-HDMI-OPT-IB card. Their behaviour is same as other cards now (dynamic edids, edid switching, etc.)
- RS232 over fiber feature can be disabled per port basis. The default state is disabled. EDID is read only on the output port, if the serial passthru is disabled.
- MX-HDMI-3D-IB and MX-HDMI-3D-OB are supported.
- Omron SX51TX optical transmitter module (MX-HDMI-OPT-OB) has 0 default value for "waveform select" as this proved to result better performance on shorter cables.

#### Bugfix

- Turning the laser quickly on/off on the HDMI-OPT-OB card from the controlsw resulted in connection loss with the HDMI-OPT-receiver device.
- Sometimes random 0x03 characters were sent to odd MX-HDMI-OPT-OB serial ports.

#### 3.3.1

Released: 2012-10-19

#### New feature

- MX-DVI-OPT-OB-RCLK SCH\_2.2 support
- MX-3GSDI-IB now supports 3GSDI Level B signals: 1080p 50Hz and 60Hz

#### Bugfix

- If an output was connected to "input 0" (disconnected), then it was switched to input 1 after a front panel-switching
- If the LAN used Protocol#2 and RS232 used LW protocol, then the responses for the front panel switches were not sent to the RS232 port.
- Connecting an output to input 0 (disconnected) when at least one dual link input card was present in the router may have caused fatal crosspoint switching error.
- The Validity bit was set wrong in audio sample packets SB6 byte when PCM audio was transmitted. Affected cards: MX-HDMI-IB/OB, MX-DVI-HDCP-IB/OB, MX-HDMI-TP-IB/OB, Test input, Preview output.



- If MX-HDMI-IB/MX-DVI-HDCP-IB/MX-HDMI-TP-IB/Test input was used, then the SPDIF outputs sent copyrighted (copy protected) material. Now the content protection is turned off on SPDIF outputs on the MX-HDMI-OB card.
- When MXD-UMX-IB digitalized an analog audio signal, then the SPDIF stream was marked as professional application. This wasn't right for some professional SPDIF receivers.
- MXD-HDMI-3D-IB/OB marked the digitalized analog audio as professional copyrighted material. Now it is marked as consumer non-protected material because this prevents some SPDIF interoperability issues.
- Digital signals with <40px back porch had sometimes strange recolor effects with MX-DVII-IB and MXD-UMX-IB board.
- If the MX-DVII-IB or the MXD-UMX-IB has been received HDMI YUV (444 or 422) signal and the user set the input video signal source with the :DVII command again to auto or digital mode (DVII command first parameter is S or D), then the image got greenish tint. This was because using incorrect YUV-RGB color conversion matrix.
- If the MXD-UMX-IB has been embedded audio from the audio add-on panel into the DVI/HDMI stream, and the user set the input video signal source with the :DVII command again to auto or digital mode (DVII command first parameter is S or D), then the image was blinking for a few seconds (and therefore audio was also muted for a while). This was because the TMDS clock was disabled while reapplying some settings. Now this flashing and audio dropout is eliminated.
- MX-HDMI-3D-OB and MX-HDMI-3D-IB - several bugfixes related to test pattern modes, HDCP and infoframes.
- If the IP address starts with 0 it is not displayed from now. e.g.: before this fix: "IP: 192.168.002.068" from now: "IP: 192.168.2.68"
- DVIDL-IB EQ settings worked only for the first two output and port numbers were misindexed.
- fixed MX-3GSDI-IB audio crosspoint initialization, audio channel status and audio infoframe content.
- MX-HDMI-3D-IB didn't work well with 4x20 character LCD display

### 3.3.2

Released: 2012-11-12

#### Bugfix

- MX-3GSDI-IB bugfix: the card sent GS2971 alert sometimes, when video signal was detected.

### 3.3.3

Released: 2013-01-17

#### New feature

- CPU SCH version is displayed in the LCD menu (among the Installed cards - both LCD types are supported)
- The serial number of the CPU and I/O boards are saved to the SD card log during the boot process.

### 3.3.4

Released: 2013-01-28

#### Bugfix

- The image was shifted one pixel to the right with digital signals. Affected cards: MX-DVII-HDCP-IB, MXD-UMX-IB

### 3.3.5

Released: 2013-03-04

#### Bugfix

- IO card SN numbers may cause stability issues.

### 3.3.6

Released: 2013-05-23

#### New feature

- MX-TPS-OB, MX-TPS-OB-A, MX-TPS-OB-S support (incl. serial passthru and ethernet functions)
- MX-TPS-IB, MX-TPS-IB-A, MX-TPS-IB-S support (incl. serial passthru and ethernet functions)
- File uploading to SD card through Lightware protocol. (needed for TPS fw upgrade)

#### Bugfix

- The LCD screen didn't show the analog audio options for the MX-HDMI-3D
- If a dynamic EDID memory slot had been empty and new EDID was read from one output, then the output validity table was showed as being invalid EDID after reading the EDID header until the first reboot.
- The audio sample frequency was unstable at 1080p60, this may have resulted crunches on the S/PDIF output with DVII input.
- HDCP keycounter sometimes resulted with 0 key with certain devices due to a short timeout. Now this is fixed.
- The MX-DVII-IB and the MX-UMX-IB boards sometimes didn't detect the 36 bpp - 24 bpp deep color change, and remained in 36bpp mode.

- MX-DVII-IB, MXD-UMX-IB: SPD Infoframe was sent with wrong header, could cause issues with deep color signal. Stored settings block was too large on these cards.
- If an MX-HDMI-3D-IB card was present at the 1st input slot and any output was connected to the 0th input (ie. disconnected), then the matrix has continuously rebooted.
- A noisy incoming signal may disable input ports on MX-HDMI-IB, MX-DVI-HDCP-IB, MX-HDMI-TP-IB and CPU test input (signals were detected appropriately but not forwarded to the crosspoint). The only solution was to restart the whole router, however the issue has appeared very rare. This issue is fixed now.

### 3.3.7

Released: 2013-08-22

#### New feature

- Temperature sensor readbacks on the MX-TPS-IB/OB cards.
- Logfile reading speed has been increased a lot. LAN connection speed is around 5kbyte/sec, while the RS232 port utilizes the full bandwidth (depending on the actual baudrate)
- Errorlevel handling is modified: recoverable issues will not display on the LCD and they will not trigger the alarm LED.
- Ethernet can be disabled or enabled per port basis on TPS-IB/OB cards
- HDBase-T HDCD database is used to recognise remote devices
- The minimum assertion time for hotplug line is 1.5 sec on the MX-HDMI-IB, MX-HDMI-TP-IB, MX-DVI-HDCP-IB, MX-DVII-IB, MXD-UMX-IB, MX-HDMI-3D-IB (and variants), MX-TPS-IB (and variants) cards and test input port. This is 15 times greater than the required minimum by the standard. The intention of this extra long HPD pulse is prevent the non-standard devices to miss the hpd event.

#### Bugfix

- A false "SBTB error" message has appeared on the LCD screen after boot if at least one MX-DVIDL-OB card was installed in the frame. This issue persisted only with 3.3.6
- Changing audio mode on a port could have an effect on the adjacent port's audio mode. Affected cards: MX-HDMI-3D-IB, MX-HDMI-3D-OB, MX-TPS-IB, MX-TPS-OB.
- When the source stopped sending audio in HDMI stream, the ports did not detect it correctly in some cases, and still reported embedded audio. Affected cards: MX-HDMI-3D-IB, MX-HDMI-3D-OB, MX-TPS-IB, MX-TPS-OB



- Factory default test pattern changed from solid black to color bar. Affected cards: MX-HDMI-3D-IB, MX-HDMI-3D-OB, MX-TPS-IB, MX-TPS-OB
- Deep color problem with DELL U2410 fixed. Affected cards: MX-HDMI-3D-IB, MX-HDMI-3D-OB, MX-TPS-IB, MX-TPS-OB
- When an HDMI 1.3 output was muted after receiving deep color signal, low resolution signals (below 41 MHz TMDS clock) was not detected by the port after unmute. Fixed. Affected cards: MX-HDMI-OB, MX-DVI-HDCP-OB, MX-HDMI-TP-OB, MX-CPU2 (Preview output).
- When no embedded audio was present on a port, noise was detected on S/PDIF outputs, which were used to deembed audio. Fixed on MX-HDMI-3D-IB-S, MX-HDMI-3D-OB-S, MX-HDMI-OB, MX-TPS-IB-S, MX-TPS-OB-S.
- SPDIF clicking/popping noise bug fix. When there was no audio sample packet in the stream (but ACR packets were still present), the MX-HDMI-OB, MX-DVI-HDCP-OB and preview output have sent a 53Khz invalid SPDIF signal. This caused a clicking noise with some AV receiver.
- Audio embedding fixed (it failed in some cases, when the user changed Audio mode to Embed from aux audio). Affected cards: MX-HDMI-3D-IB, MX-HDMI-3D-OB, MX-TPS-IB, MX-TPS-OB

### 3.3.8

Released: 2013-10-01

#### Bugfix

- PWR\_x commands responded "Invalid command" if sent to frame that is smaller than 80x80. These commands are only valid for the 80x80 frame.
- If input signal was present on a SII9575 port and test pattern mode was changed from "Off" to "No signal mode", SII9575 output had been turned off for a short period unnecessarily. Fixed. Affected cards: MX-HDMI-3D-IB, MX-HDMI-3D-OB, MX-TPS-IB, MX-TPS-OB.
- Deembedded audio outputs (analog, S/PDIF) become stable more quickly after input signal is changed. Affected cards: MX-HDMI-OB, MX-TPS-OB-S, MX-TPS-OB-A, MX-HDMI-3D-OB-S, MX-HDMI-3D-OB-A.
- Firmware v3.3.7 sometimes rebooted with 2 or 4 line LCD display.
- The cycle testpattern has stopped sometimes for a few minutes.
- If an error happened during the booting process, there was no alert displayed on the LCD screen (however the event has been logged).

- If the errorlog menu was active on the 4-line LCD screen, then a new incoming alert may confuse the lines on the LCD screen.
- Lightware simple protocol mode (P\_3) could hang if an unknown command had been received.
- When the USB connector was used from the Matrix Controller software, every incoming character was capitalized. This led to unexpected results while using the ROF (RS232 over fiber / TPS) commands.
- Error log downloading over USB was bugous.

### 3.3.9

Released: 2013-10-22

#### Bugfix

- Display Range Limits Descriptor was not correct in factory EDIDs (except universal EDIDs).

### 3.4.0

Released: 2014-01-13

#### New feature

- MX-HDMI-OPT-OB-R support has been added.
- New factory EDIDs have been added: 3D compliant, 4K, 4K universal EDIDs and most often used pc graphics resolutions with audio support.

#### Bugfix

- The serial port extension sometimes transmitted/received bugous data on the TPS boards.
- If one or more MX-TPS-IB or MX-TPS-OB (including audio addon versions) were installed in the frame, sometimes a false flashing "PCA9673" error appeared on the LCD screen.
- When DVII input board was used with MX-HDMI-3D-OB or MX-TPS-OB, the output ports could measure strange resolution or could not detect the incoming signal, if the DVII input changed from no sync screen to incoming signal. Fixed.
- Green sparks could appear in the output signal of MX-HDMI-3D-OB, if the input signal was coming from MX-HDMI-3D-IB and was switched between 1080p and 480p by the crosspoint.

### 3.4.1

Released: 2014-03-31

#### Bugfix

- Some monitors that do not terminate the TMDS lines in standby mode, could not wake up from this state, when input signal was connected through MX-HDMI-3D-OB or MX-TPS-OB. This issue is now fixed by powering up the output ports not only when TMDS termination is present, but also after a hotplug event. Affected cards: MX-HDMI-3D-OB, MX-TPS-OB.
- 4line LCD - View EDID menu froze the LCD task if there were no IO cards in the matrix.
- 4line LCD - FR80 - View EDID did not show the 81st input and output.
- 4line LCD - View EDID - Dynamic EDIDs was not displayed if there were no input cards in the same numbered slot (the problem was checking the input cards instead of the output cards)
- Too long lines in the error log may have disrupted the log reading if special characters were used.
- The text of the test pattern generator clock menu on the LCD screen was disambiguous.
- There was no error message if SX51 was configured to SX4.
- 4-line LCD - The S/N number of the output cards were not shown in the card information menu.

### 3.4.2

Released: 2014-05-26

#### New feature

- MX-HDMI-OPT-OB supports HDCP auto/always function now.

### 3.4.3

Released: 2014-06-27

#### Bugfix

- A rare ADM1063 false alarm has appeared on the LCD or sometimes the internal voltages were reported improperly. Affected frame: MX-FR80

### 3.4.4

Released: 2014-10-08

#### New feature

- UMX-TPS devices handle the command channel even in disabled receive mode, serial packets are discarded.
- IP configuration via RS-232.

- Logging data extended, if VS100 holds I2C SCL line down. VS100\_getHpdStatus function added (previously this register was checked in handler periodically, but it was removed in order to reduce the number of remote read transactions to prevent VS100 I2C lockdowns).

**Bugfix**

- TPS write functions fixed in disabled receive mode.
- VSNACK and SII9575 errors fixed on MX-TPS-IB and MX-TPS-OB.

**3.4.5**

Released: 2015-01-28

**New feature**

- MX-3GSDI-IB converts every video signal to RGB444.

**Bugfix**

- Plugging a monitor into the FR80's Preview Output caused reloading of factory default EDID to all inputs.
- Alphanumeric characters in the factory EDIDs (like display name field) were not padded properly.
- Factory default IP can be set with controlboard buttons.
- Factory EDID revision number has been set to 1.3 instead of 1.4 now. This may prevent compatibility issues (usually the source didn't see the connected device as audio capable) with old graphics card drivers.
- Analog YUV support has been removed from the basic EDID structures of factory EDIDs.
- From now on MX-DVII-HDCP-IB and MXD-UMX-IB cards always send 24bpp signal into the crosspoint switch. The 36bpp signals caused signal integrity problems in some rare conditions which could result in audio popping noise.

**3.4.6**

Released: 2015-07-27

**New feature**

- Added support for MX-HDMI-3D-STEREO-ADDON v20.
- Added support for MX-TPS2-IB/OB (and variants).
- If the temperature of the TPS or TPS2 card increases above 80C, it is logged into the SD card.
- Added support for MX-3GSDI-IB v20.

**Bugfix**

- Some residual power from the output cards (from the connected sink devices) could keep the CPU alive in MX-FR80 and MX-FR65 frames even after removing the AC cords. This resulted false alarms on the LCD and in the log files. This condition is detected and handled now.
- MX-HDMI-3D-OB and MX-TPS-OB could not handle if one of the DDC lines was broken. It could cause VTASK RESET and SII9575 errors. Fixed.
- MX-FR80 logged a false "MTRI setXpoint" error after crosspoint switching.
- Improved error notifications on the 2 and 4 line LCD.
- AVI Infoframes were set improperly on MX-3GSDI-IB. This caused random video drops with some displays.
- Emulated EDID is updated now if the source user EDID is changed.
- The appropriate validity flag is set when a user EDID changes.

**3.4.7**

Released: 2015-08-14

**Bugfix**

- Fixed MXSC (Status board) CPU LIVE LED blinking.

**3.4.8**

Released: 2015-12-01

**New feature**

- Added support for MX-AUDIO-OB-A board.
- 4K 60Hz 4:2:0 EDID has been added as 113th Factory EDID.

**Bugfix**

- 4K 60Hz 4:2:0 resolution was falsely reported back as 1920x2160p60

**3.4.9**

Released: 2016-04-22

**New feature**

- Added support for MX-4TPS2-4HDMI-IB cards.

**Bugfix**

- [MXFR-3005] MX-3GSDI-IB did not work if an MX-HDMI-OPT-OB was in the matrix.

**3.5.0**

Released: 2017-01-16

**New feature**

- Support for Omron (Inneos) 'F' type modules (DVI-OPT-OB and HDMI-OPT-OB)

**Bugfix**

- Cyviz XPO4 HDCP error fixed: SII9575 stopped HDCP authentication, if the sink reported all 0 bytes as KSV by mistake.
- HDMI-3D-OB (and TPS-OB) default audio config changed to 'E' (passthrough and deembed)

**3.5.1**

Released: 2017-04-20

**New feature**

- Added support for MX-4TPS2-4HDMI-OB cards.

**3.5.2**

Released: 2017-04-25

**Bugfix**

- Response for VC command fixed for dual-link outputs if the output is routed to input 0 (mute). Before: {0@1}{vc} (ALL 00 01) After fix: {0@1}{vc} (ALL 00 00)

**3.5.3**

Released: 2017-07-17

**New feature**

- Improvements for manufacturing tests.

**3.5.4**

Released: 2017-07-17

**Bugfix**

- Improves stability with MX-3GSDI-IB.

**3.5.5**

Released: 2018-10-09

**Bugfix**

- Improved the final manufacturing test processes.

**3.5.6**

Released: 2019-03-26

**New feature**

- Added support for MX-DVI-4K-IB and MX-DVI-4K-OB boards.

**v3.5.7b8**

Release date: 2020-01-30

**New feature:**

- Support for new TPS devices.
- New product supports: MX-FR9R, MX-FR17R

### 11.8. Mechanical Drawings

#### 11.8.1. MX-FR80R and MX-FR65R

Front view

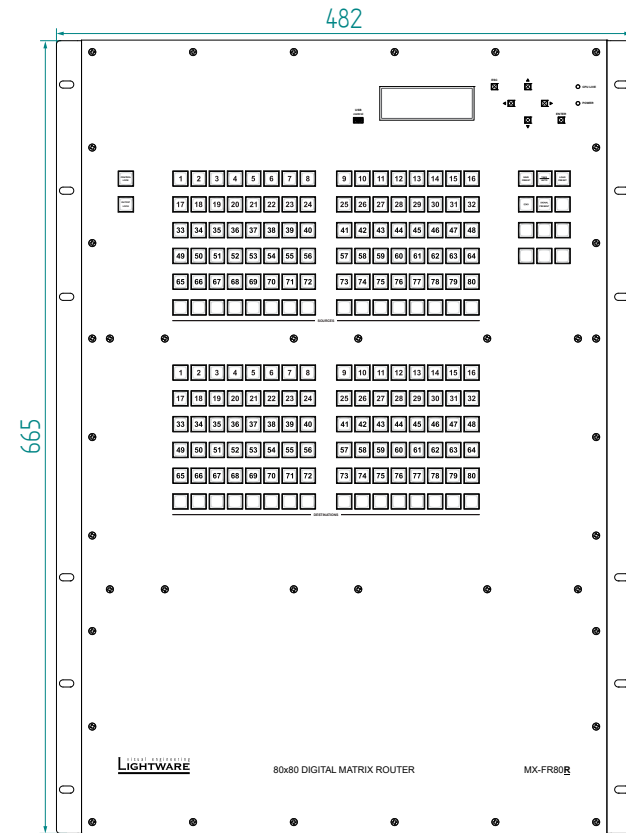

Rear view

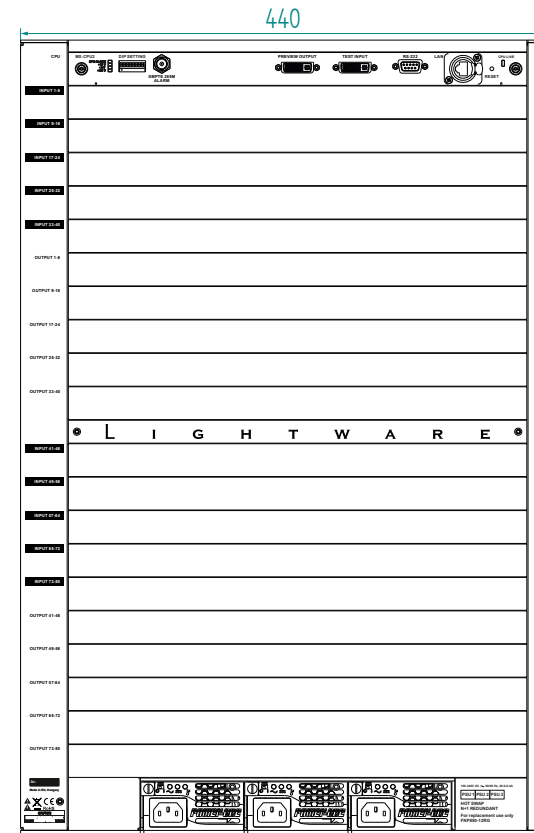

Right view

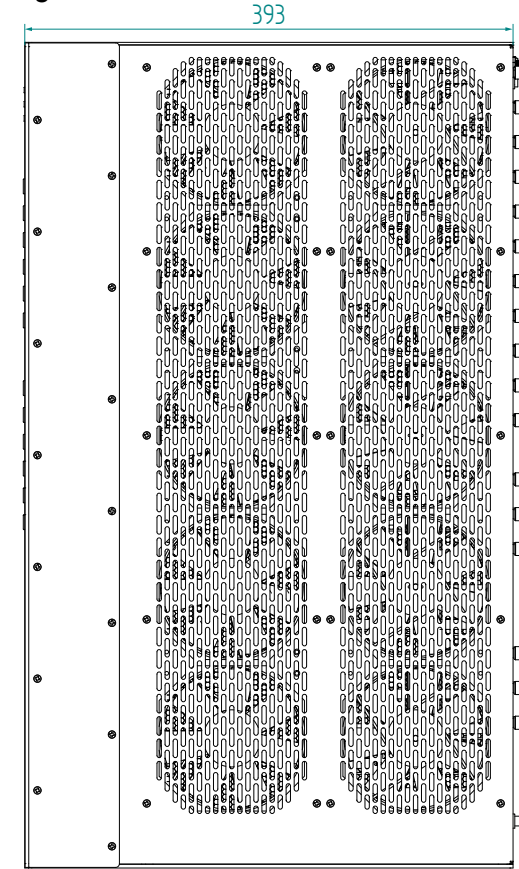

Top view

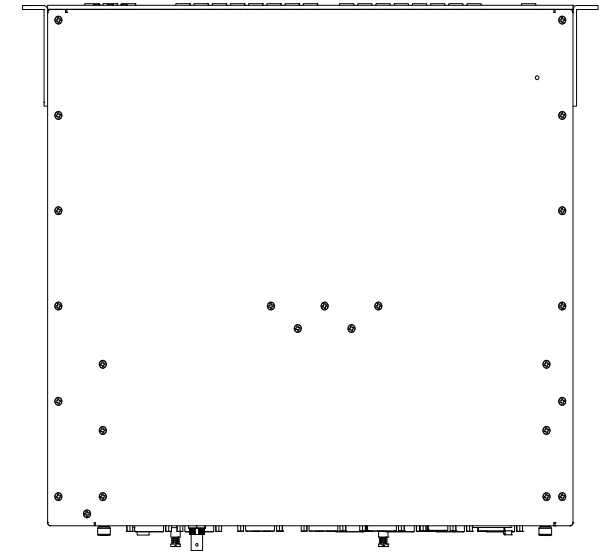



11.8.2. MX-FR33R

Front view

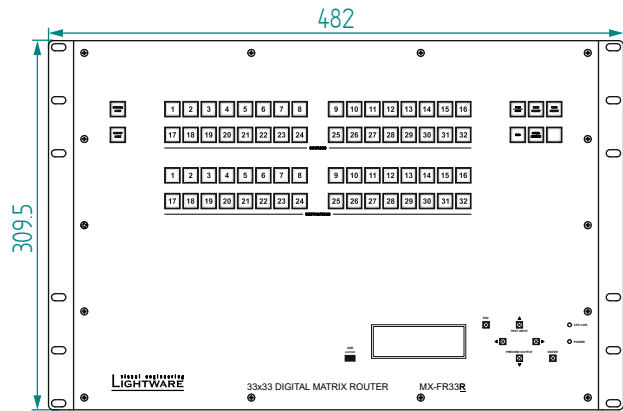

Rear view

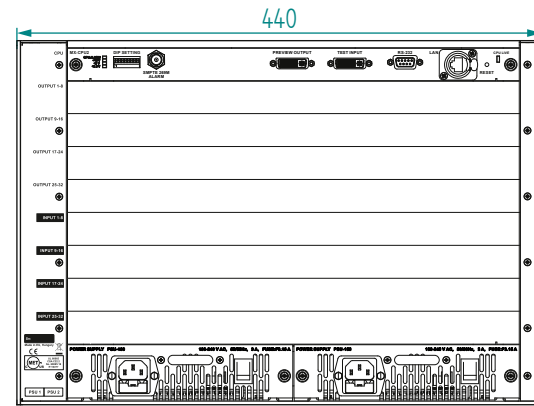

Top view

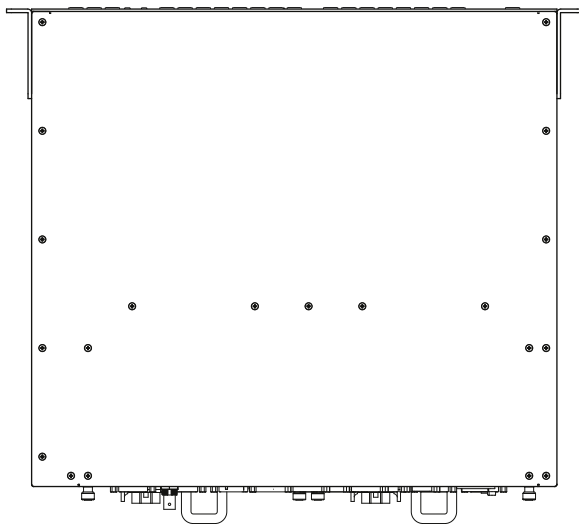

Left view

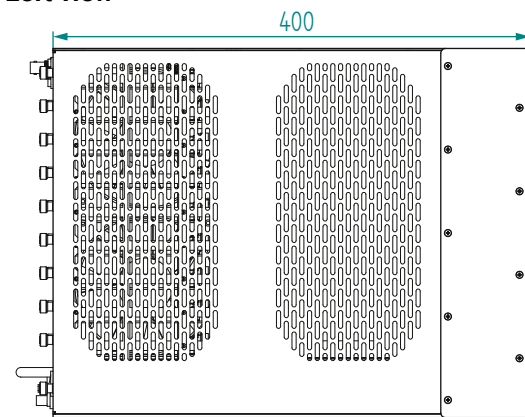

11.8.3. MX-FR33L

Front view

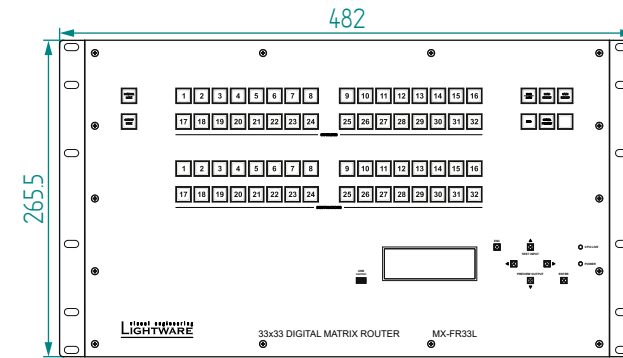

Rear view

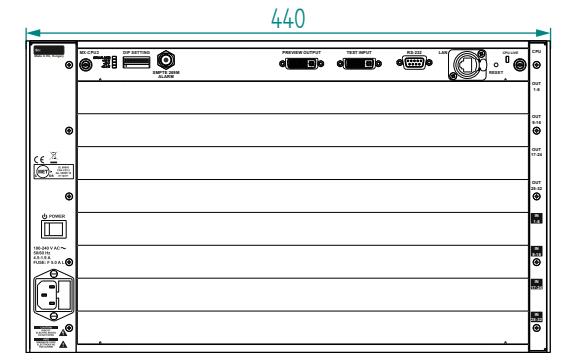

Top view

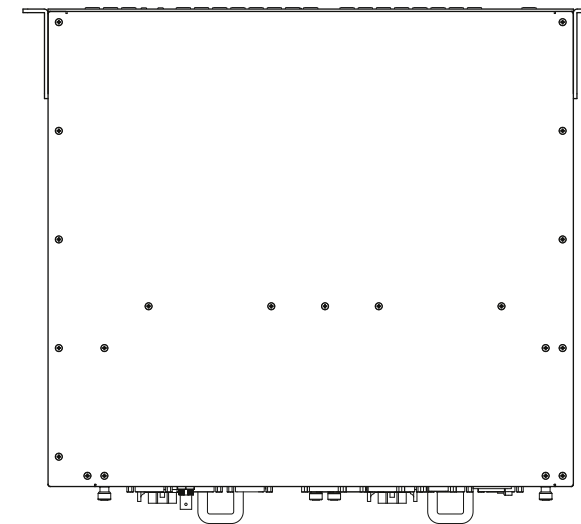

Left view

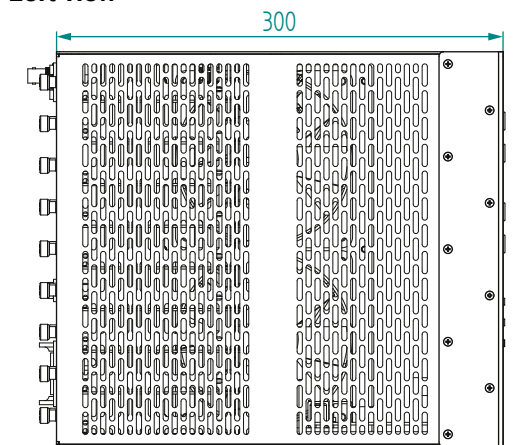

### 11.8.4. MX-FR17 and FR17R, MX-FR9 and FR9R

INFO: Certain parts are different in above mentioned models, but the external dimensions are the same.

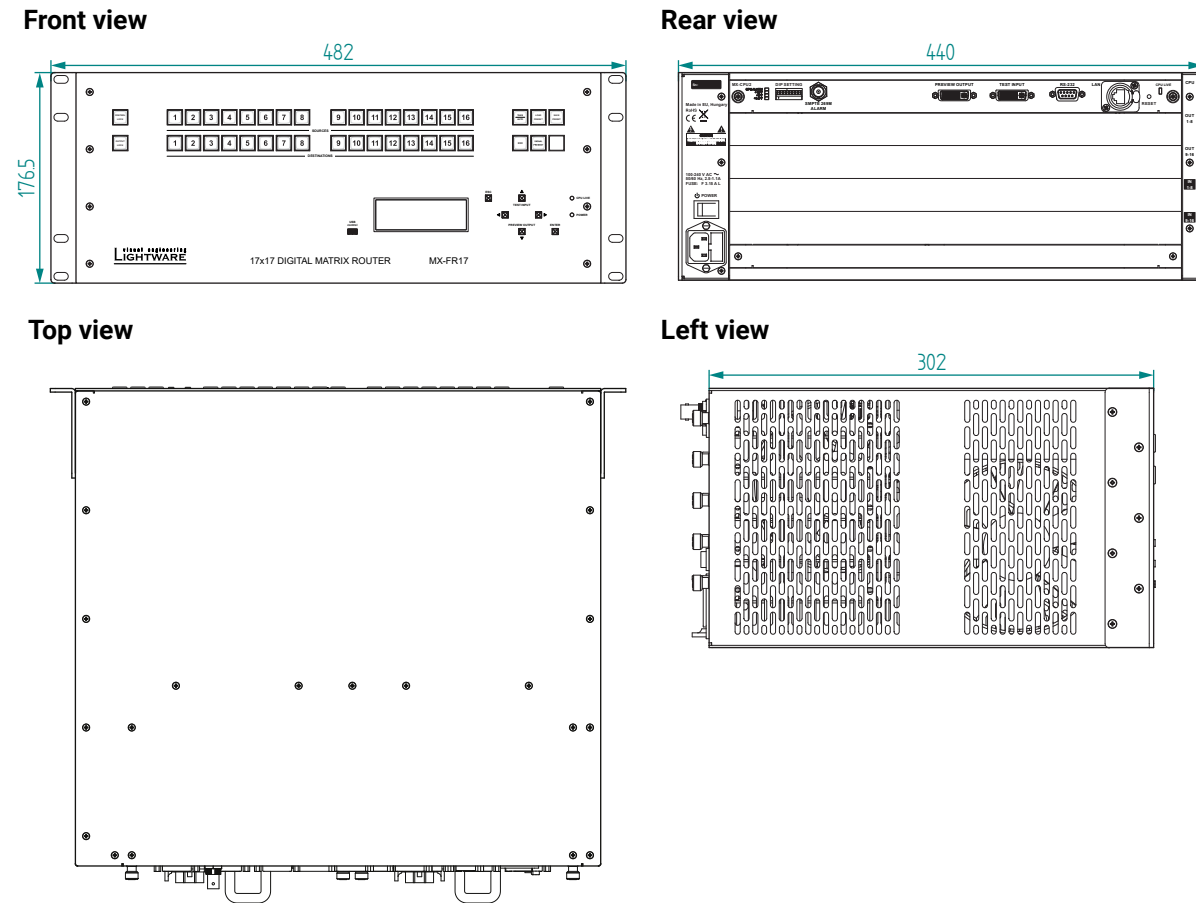

### 11.9. ASCII Table

The most common used characters are highlighted with blue.

Dec	Hex	Char	Dec	Hex	Char	Dec	Hex	Char	Dec	Hex	Char
0	00	[NUL]	32	20	[Space]	64	40	@	96	60	`
1	01	[SOH]	33	21	!	65	41	A	97	61	a
2	02	[STX]	34	22	"	66	42	B	98	62	b
3	03	[ETX]	35	23	#	67	43	C	99	63	c
4	04	[EOT]	36	24	\$	68	44	D	100	64	d
5	05	[ENQ]	37	25	%	69	45	E	101	65	e
6	06	[ACK]	38	26	&	70	46	F	102	66	f
7	07	[BEL]	39	27	'	71	47	G	103	67	g
8	08	[BS]	40	28	(	72	48	H	104	68	h
9	09	[TAB]	41	29	)	73	49	I	105	69	i
10	0A	[LF]	42	2A	*	74	4A	J	106	6A	j
11	0B	[VT]	43	2B	+	75	4B	K	107	6B	k
12	0C	[FF]	44	2C	,	76	4C	L	108	6C	l
13	0D	[CR]	45	2D	-	77	4D	M	109	6D	m
14	0E	[SOH]	46	2E	.	78	4E	N	110	6E	n
15	0F	[SI]	47	2F	/	79	4F	O	111	6F	o
16	10	[DLE]	48	30	0	80	50	P	112	70	p
17	11	[DC1]	49	31	1	81	51	Q	113	71	q
18	12	[DC2]	50	32	2	82	52	R	114	72	r
19	13	[DC3]	51	33	3	83	53	S	115	73	s
20	14	[DC4]	52	34	4	84	54	T	116	74	t
21	15	[NAK]	53	35	5	85	55	U	117	75	u
22	16	[SYN]	54	36	6	86	56	V	118	76	v
23	17	[ETB]	55	37	7	87	57	W	119	77	w
24	18	[CAN]	56	38	8	88	58	X	120	78	x
25	19	[EM]	57	39	9	89	59	Y	121	79	y
26	1A	[SUB]	58	3A	:	90	5A	Z	122	7A	z
27	1B	[ESC]	59	3B	;	91	5B	[	123	7B	{
28	1C	[FS]	60	3C	<	92	5C	\	124	7C	
29	1D	[GS]	61	3D	=	93	5D	]	125	7D	}
30	1E	[RS]	62	3E	>	94	5E	^	126	7E	~
31	1F	[US]	63	3F	?	95	5F	_	127	7F	[Del]

## 11.10. Hashtag Keyword List

This user's manual contains keywords with hashtag (#) to help you to find the relevant information as quick as possible.

The format of the keywords is the following:

#<keyword>

The usage of the keywords: use the **Search** function (Ctrl+F / Cmd+F) of your PDF reader application, type the # (hashtag) character and the wished keyword.

The **#new** special keyword indicates a new feature/function that has just appeared in the latest firmware or software version.

### Example

*#dhcp*

This keyword is placed at the DHCP (dynamic IP address) setting in the front panel operation, the Lightware Device Controller (LDC) and the LW2 programmer's reference section.

The following list contains all hashtag keywords placed in the document with a short description belonging to them. The list is in **alphabetical order** by the hashtag keywords.

Hashtag Keyword ↓↑	Description
<i>#analogaudio</i>	Analog audio related settings
<i>#audio</i>	Audio related settings
<i>#autotakemode</i>	Autotake mode
<i>#builtinweb</i>	Built-in web
<i>#button</i>	Front panel button operations
<i>#controllock</i>	Front panel control lock
<i>#controlprotocol</i>	Control protocol (LW2 / LW3) query
<i>#crosspoint</i>	Crosspoint switch setting
<i>#date</i>	Date setting
<i>#devicelabel</i>	Product type
<i>#dhcp</i>	Dynamic IP address (DHCP) setting
<i>#edid</i>	EDID related settings
<i>#firmwareversion</i>	Firmware version query
<i>#framedetector</i>	Frame detector in LDC/built-in web
<i>#gain</i>	Gain (for analog audio) setting
<i>#gridview</i>	Grid view in LDC

Hashtag Keyword ↓↑	Description
<i>#hdcpc</i>	HDCP-encryption related setting
<i>#ipaddress</i>	IP address related settings
<i>#label</i>	Device label
<i>#lock</i>	Port lock settings
<i>#mute</i>	Port mute setting
<i>#network</i>	Network (IP address) related settings
<i>#nosyncscreen</i>	Test pattern (no sync screen) settings
<i>#outputlock</i>	Front panel output lock
<i>#power</i>	Power supply and redundancy related information
<i>#power5v</i>	HDMI 5V power mode setting
<i>#preset</i>	Preset related settings
<i>#reboot</i>	Restarting the device
<i>#redundancy</i>	Power supply and redundancy related information
<i>#reset</i>	Restarting the device
<i>#restart</i>	Restarting the device
<i>#rs232</i>	RS-232 related settings
<i>#rs-232</i>	RS-232 related settings
<i>#serial</i>	RS-232 related settings
<i>#switch</i>	Crosspoint switch setting
<i>#takemode</i>	Take mode
<i>#terminal</i>	Advanced view window
<i>#testpattern</i>	Test pattern (no sync screen) settings
<i>#tileview</i>	Tile view in LDC
<i>#time</i>	Time setting
<i>#unlock</i>	Port unlock settings
<i>#unmute</i>	Port unmute setting
<i>#volume</i>	Volume (for analog audio) setting
<i>#web</i>	Built-in web

## 11.11. Further Information

### Limited Warranty Statement

1. Lightware Visual Engineering LLC (Lightware) warrants to all trade and end user customers that any Lightware product purchased will be free from manufacturing defects in both material and workmanship for three (3) years from purchase unless stated otherwise below. The warranty period will begin on the latest possible date where proof of purchase/delivery can be provided by the customer. In the event that no proof can be provided (empty 'Date of purchase' field or a copy of invoice), the warranty period will begin from the point of delivery from Lightware.

1.1. 25G and MODEX product series will be subject to a seven (7) year warranty period under the same terms as outlined in this document.

1.2. If during the first three (3) months of purchase, the customer is unhappy with any aspect of a Lightware product, Lightware will accept a return for full credit.

1.3. Any product that fails in the first six (6) months of the warranty period will automatically be eligible for replacement and advanced replacement where available. Any replacements provided will be warranted for the remainder of the original unit's warranty period.

1.4. Product failures from six (6) months to the end of the warranty period will either be repaired or replaced at the discretion of Lightware. If Lightware chooses to replace the product then the replacement will be warranted for the remainder of the original unit's warranty period.

2. The above-stated warranty and procedures will not apply to any product that has been:

2.1. Modified, repaired or altered by anyone other than a certified Lightware engineer unless expressly agreed beforehand.

2.2. Used in any application other than that for which it was intended.

2.3. Subjected to any mechanical or electrical abuse or accidental damage.

2.4. Any costs incurred for repair/replacement of goods that fall into the above categories (2.1., 2.2., 2.3.) will be borne by the customer at a pre-agreed figure.

3. All products to be returned to Lightware require a return material authorization number (RMA) prior to shipment and this number must be clearly marked on the box. If an RMA number is not obtained or is not clearly marked on the box, Lightware will refuse the shipment.

3.1. The customer will be responsible for in-bound and Lightware will be responsible for out-bound shipping costs.

3.2. Newly repaired or replaced products will be warranted to the end of the originally purchased products warranty period.

### Document Revision History

Rev.	Release date	Changes	Editor
Rev. 1.0	19-10-2012	Initial version	Tamas Lehel
⋮			
Rev 3.0	19-02-2018	New document format introduced; pictures of I/O boards and frames have been replaced; combi output boards added; minor graphical and content update.	Laszlo Zsedenyi
Rev 3.1	21-10-2019	MX-DVI-4K I/O boards added, PSU handling section added, I/O board replacement section added, Drawings updated due to minor changes, Specifications appended (frame weight), Firmware release notes added	Laszlo Zsedenyi
Rev 3.2		MX-FR9R and MX-FR17R models added, LW2 chapter restructured, Remote power chapter added, Hashtag keywords added, Document size optimized.	Laszlo Zsedenyi

### Contact Us

[sales@lightware.com](mailto:sales@lightware.com)

+36 1 255 3800

[support@lightware.com](mailto:support@lightware.com)

+36 1 255 3810

**Lightware Visual Engineering LLC.**  
Peterdy 15, Budapest H-1071, Hungary

[www.lightware.com](http://www.lightware.com)

©2020 Lightware Visual Engineering. All rights reserved. All trademarks mentioned are the property of their respective owners. Specifications subject to change without notice.