

visual engineering
LIGHTWARE

User's Manual

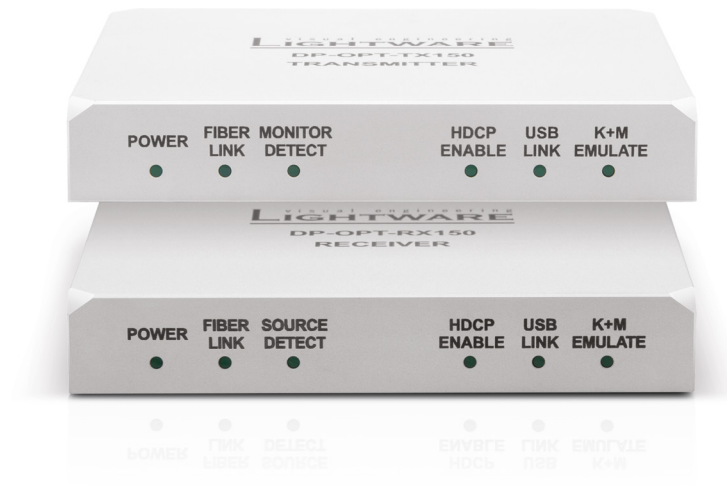

DP-OPT-TX150
DP-OPT-RX150

Fiber Optical Multimedia Extender

Important Safety Instructions

To disconnect the equipment safely from power, remove the power cord from the rear of the equipment, or from the power source. The MAINS plug is used as the disconnect device, the disconnect device shall remain readily operable.

There are no user-serviceable parts inside of the unit. Removal of the cover will expose dangerous voltages. To avoid personal injury, do not remove the cover. Do not operate the unit without the cover installed.

The appliance must be safely connected to multimedia systems. Follow instructions described in this manual.

Ventilation

For the correct ventilation and to avoid overheating ensure enough free space around the appliance. Do not cover the appliance, let the ventilation holes free and never block or bypass the ventilators (if any).

WARNING

To prevent injury, the apparatus is recommended to securely attach to the floor/wall or mount in accordance with the installation instructions. The apparatus shall not be exposed to dripping or splashing and that no objects filled with liquids, such as vases, shall be placed on the apparatus. No naked flame sources, such as lighted candles, should be placed on the apparatus.

Waste Electrical & Electronic Equipment WEEE

This marking shown on the product or its literature, indicates that it should not be disposed with other household wastes at the end of its working life. To prevent possible harm to the environment or human health from uncontrolled waste disposal, please separate this from other types of wastes and recycle it responsibly to promote the sustainable reuse of material resources. Household users should contact either the retailer where they purchased this product, or their local government office, for details of where and how they can take this item for environmentally safe recycling. Business users should contact their supplier and check the terms and conditions of the purchase contract. This product should not be mixed with other commercial wastes for disposal.



Caution: Laser product

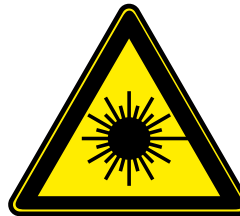

Common Safety Symbols

Symbol	Description
	Direct current
	Alternating current
	Double insulation
	Laser radiation
	Caution: for indoor use only

Symbol Legend

The following symbols and markings are used in the document:

WARNING! Safety-related information which is highly recommended to read and keep in every case!

ATTENTION! Useful information to perform a successful procedure; it is recommended to read.

INFO: A notice which may contain additional information. Procedure can be successful without reading it.

DEFINITION: The short description of a feature or a function.

TIPS AND TRICKS: Ideas which you may have not known yet but can be useful.

Navigation Buttons

 Go back to the previous page. If you clicked on a link previously, you can go back to the source page by clicking the button.

 Navigate to the Table of Contents.

 Step back one page.

 Step forward to the next page.

Document Information

All presented functions refer to the indicated products. The descriptions have been made during testing these functions in accordance with the indicated Hardware/Firmware/Software environment:

Item	Version
Lightware Device Controller (LDC) software	1.20.0
Lightware Device Updater Software	1.5.3
Controller firmware	1.1.11b0
Hardware	v11

Document revision: **2.1**

Release date: 30-10-2018

Editor: Laszlo Zsedenyi

Table of Contents

1. INTRODUCTION	5	6.1. ABOUT THE FIRMWARE PACKAGE (LFP FILE)	20
1.1. DESCRIPTION.....	5	6.2. SHORT INSTRUCTIONS	20
1.2. MODEL DENOMINATION	5	6.3. INSTALL AND UPGRADE	20
1.3. BOX CONTENTS	5	6.4. DETAILED INSTRUCTIONS	21
1.4. FEATURES OF THE DEVICE.....	5	6.4.1. Establish the Connection	21
1.5. TYPICAL APPLICATIONS	6	6.4.2. Start the LDU and Follow the Instructions	21
2. INSTALLATION	7	7. TROUBLESHOOTING	25
2.1. MOUNTING OPTIONS	7	8. TECHNOLOGIES	26
2.1.1. Rack Shelf Mounting	7	8.1. HDCP MANAGEMENT	26
2.1.2. UD-kit Mounting.....	7	8.1.1. Protected and Unprotected Content	26
2.2. CONNECTING STEPS	7	8.1.2. Real-life Examples	26
2.3. SECURITY SLOT	7	8.2. DISPLAYPORT	27
3. PRODUCT OVERVIEW	8	8.2.1. Dual mode.....	27
3.1. DP-OPT-TX150	8	9. APPENDIX	28
3.2. DP-OPT-RX150	9	9.1. SPECIFICATIONS	28
3.3. ELECTRICAL CONNECTIONS	9	9.2. MECHANICAL DRAWINGS	29
3.3.1. Fiber Optical Connector	9	9.3. FURTHER INFORMATION	30
3.3.2. DP Input and Output Ports	9		
3.3.3. USB Connectors.....	9		
4. OPERATION	10		
4.1. POWERING ON	10		
4.1.1. Setting up USB Devices.....	10		
4.2. USB MODES	10		
4.2.1. Changing the USB Mode	11		
4.3. HDCP SETTING	11		
4.4. DP MODE AND HDMI MODE	11		
5. SOFTWARE CONTROL - LIGHTWARE DEVICE CONTROLLER			
SOFTWARE	12		
5.1. INSTALL AND UPGRADE	12		
5.2. CONNECTING TO A DEVICE (DEVICE DISCOVERY WINDOW)	13		
5.3. CONTROL MENU	13		
5.3.1. Video and Link Panel.....	13		
5.3.2. Transmitter Panel	14		
5.3.3. Receiver Panel	15		
5.4. REAL-LIFE EXAMPLES (USB DEVICES AND MODES)	16		
5.5. TERMINAL MENU	18		
5.6. SETTINGS MENU	18		
5.6.1. Device information	18		
5.6.2. Log Tab.....	19		
6. FIRMWARE UPGRADE	20		

1

Introduction

Thank You for choosing Lightware's DisplayPort Fiber Optical extender devices. In the first chapter we would like to introduce the device highlighting the most important features in the below listed sections:

- ▶ [DESCRIPTION](#)
- ▶ [MODEL DENOMINATION](#)
- ▶ [BOX CONTENTS](#)
- ▶ [FEATURES OF THE DEVICE](#)
- ▶ [TYPICAL APPLICATIONS](#)

1.1. Description

DisplayPort is one of the newest video interface standards. Using DisplayPort, high resolution video and excellent quality audio can be transmitted. The interface's 10.8 Gbps bandwidth is capable of transmitting 2560x1600@60Hz pixel resolution video with full support of content protection (HDCP). UHD and 4Kx2K resolution can be achieved up to 30Hz frame rate.

Intelligent HID Emulation is provided for two devices with full transparency. The special HID devices – including keyboard and mouse – are emulated by the extender and transparently transferred to the computer with the result that no extra drivers are required for the proper functionality, it's as easy as Plug & Play. DP-OPT-TX150 has 2 extra local USB ports with a built-in HUB and can be connected to the PC/Mac with a single USB cable.

When connecting a DVI or HDMI display through an adaptor cable, Dual-mode DisplayPort graphic cards reconfigure their outputs to DVI or HDMI accordingly. Lightware DisplayPort extenders support Dual-mode port extension and adaptor cables.

Lightware's DisplayPort extenders can be used with Thunderbolt sources and devices. The extender pair and the DisplayPort monitor have to be placed at the end of the Thunderbolt chain. Apple Thunderbolt Display is not supported.

Single Fiber Technology makes these units fully DisplayPort 1.1a and HDCP 1.1 compliant without the need of a second fiber cable or copper connections. To simplify cabling, the bidirectional communication - necessary for DisplayPort Link Training, HDCP handshaking and USB transfer - is performed on the same fiber core that transmits the video signal. Both receiver and transmitter are remote configurable from either side through the mini USB connector.

1.2. Model Denomination

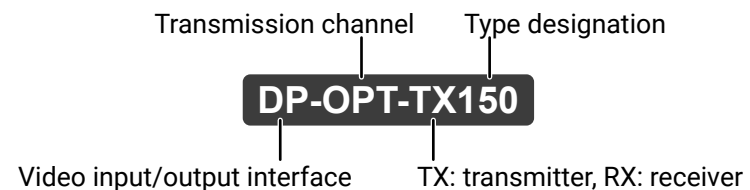

1.3. Box Contents

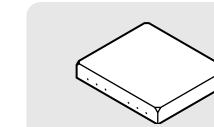

DP-OPT Transmitter
or Receiver

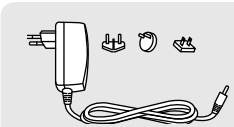

DC adaptor with
interchangeable plug

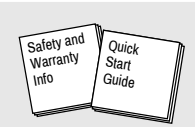

Safety and
Warranty
info, Quick Start
Guide

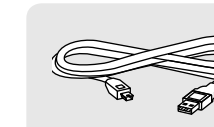

USB cable with mini-B
and type-A connector
(1 pc./extender pair)

1.4. Features of the Device



Supports Highest Resolutions

Transmitting DisplayPort 1.1a video signals up to 10.8 Gbps bandwidth, e.g. 2560x1600 pixels at 60 Hz or 4096x2400 pixels at 30 Hz.

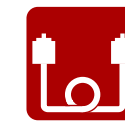

One Multimedia Fiber Cable

DisplayPort signal is transmitted using only one multimode 50/125 fiber optical cable with SC connector.



No Signal Latency With Zero Frame Delay

The signal management architecture ensures that there is no delay added between the input and the output.

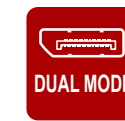

Dual-mode DisplayPort

DVI or HDMI display device can be connected to DP-OPT-RX150 through a passive adaptor thus forces the source to send DVI/HDMI signal.



HDCP Enable/Disable

When the extenders are in HDMI mode, HDCP can be enabled or disabled to prevent unnecessary encryption to ensure compatibility.



USB KVM Extension

The source computer can be controlled remotely by USB HID devices (e.g. mouse, keyboard) connected to DP-OPT-RX150, as their signal is transmitted through the fiber cable.



USB 2.0 HUB

DP-OPT-TX150 connected to a computer via USB can be used as a local USB HUB with two USB 2.0 ports.



Thunderbolt

Sources with Thunderbolt port are also supported – just connect a miniDP-DP cable between the source and DP-OPT-TX150.



Front Panel LEDs

Immediate feedback about the status of connected DP source and monitor. Fiber link-, USB- and HDCP-status are also shown on the front panel.

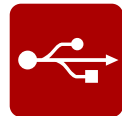

USB Control

USB management, information about connected devices and firmware upgrade can be accessed with Lightware software via USB connection.



Universal Power Adaptor

Equipped with a universal +5V DC power adaptor, which accepts AC voltages from 100 to 240 Volts with 50 or 60 Hz line frequency.



Kensington Security Slot® Support

The security slot can be found on the side of the units for theft protection.

1.5. Typical Applications

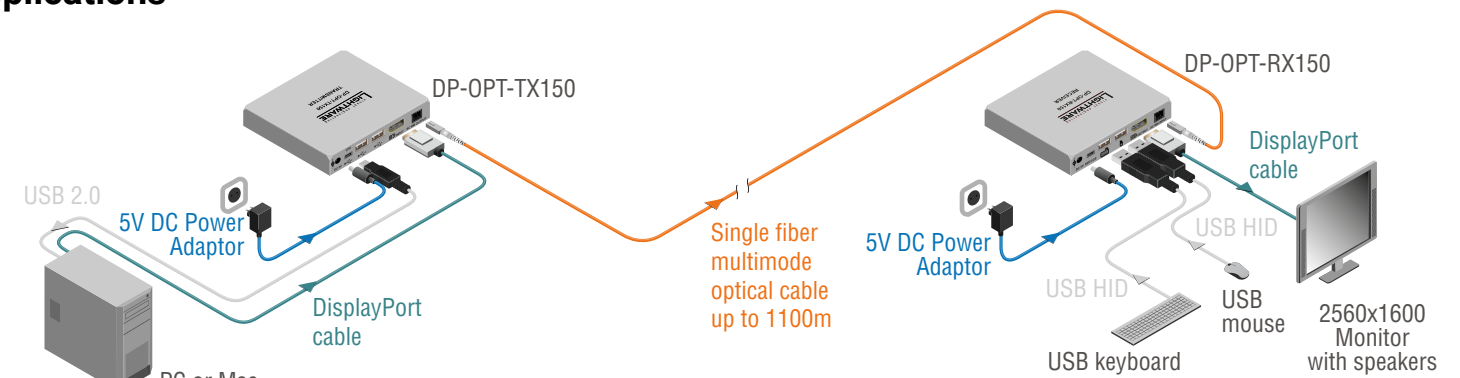

Stand-alone Diagram with a High-resolution DP monitor

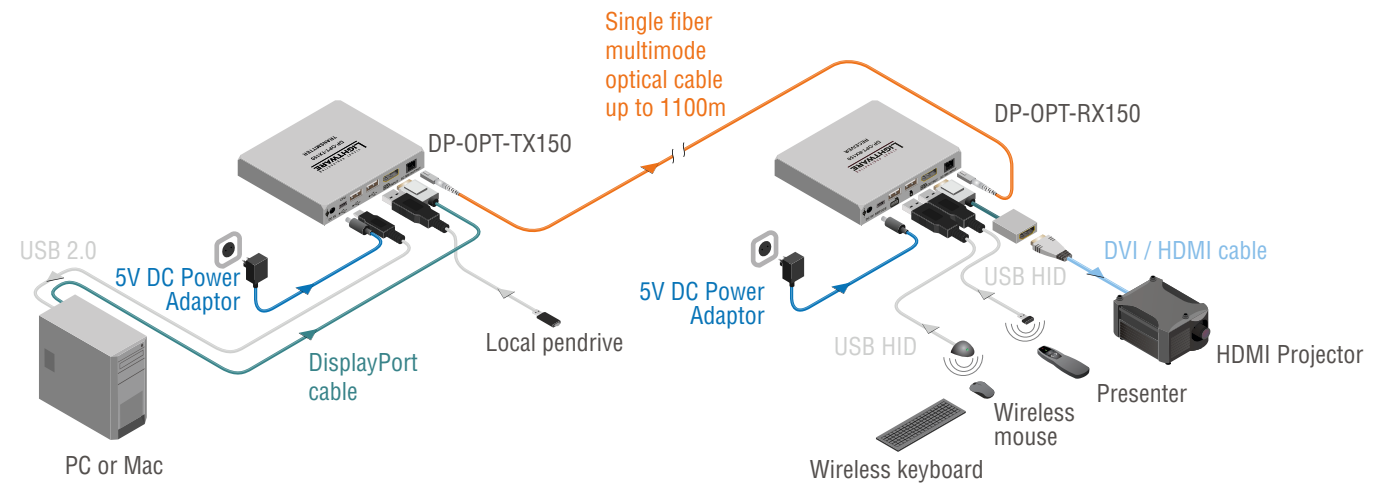

Stand-alone Diagram with an HDMI Projector

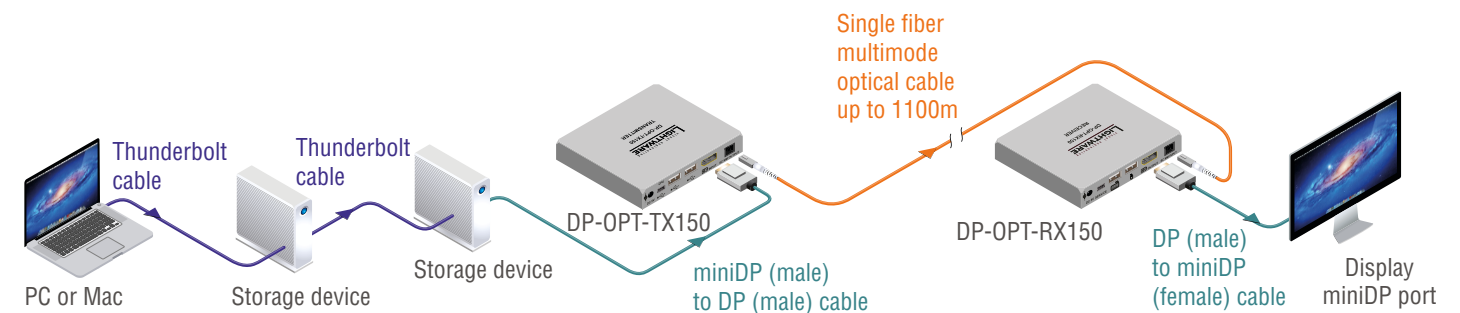

Daisy-chained Thunderbolt Devices and a LED Cinema Display

2

Installation

The chapter is about the installation of the device and connecting to other appliances, presenting also the mounting options.

- ▶ MOUNTING OPTIONS
- ▶ CONNECTING STEPS
- ▶ SECURITY SLOT

2.1. Mounting Options

WARNING! For the correct ventilation and to avoid overheating ensure enough free space around the appliance and do not cover it.

INFO: In order to get the necessary mounting accessory please contact sales@lightware.com.

2.1.1. Rack Shelf Mounting

The 1U high rack shelf provides mounting holes for fastening four DP-OPT_150 extenders and put them into a standard rack cabinet (width of the Rack shelf is 448 mm – without the ears). Fix the device to the Rack shelf as shown in the figure:

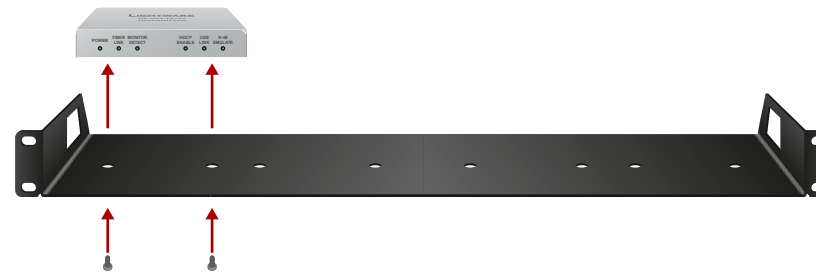

2.1.2. UD-kit Mounting

Mounting with UD-kit (Under desk)

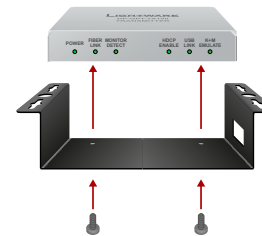

Mounting with UD-kit Double (Under Desk Double)

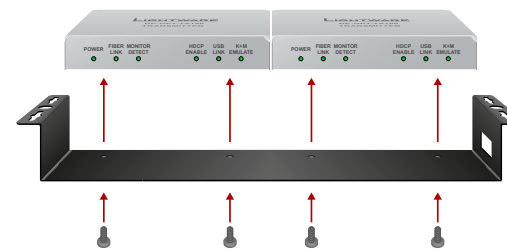

2.2. Connecting Steps

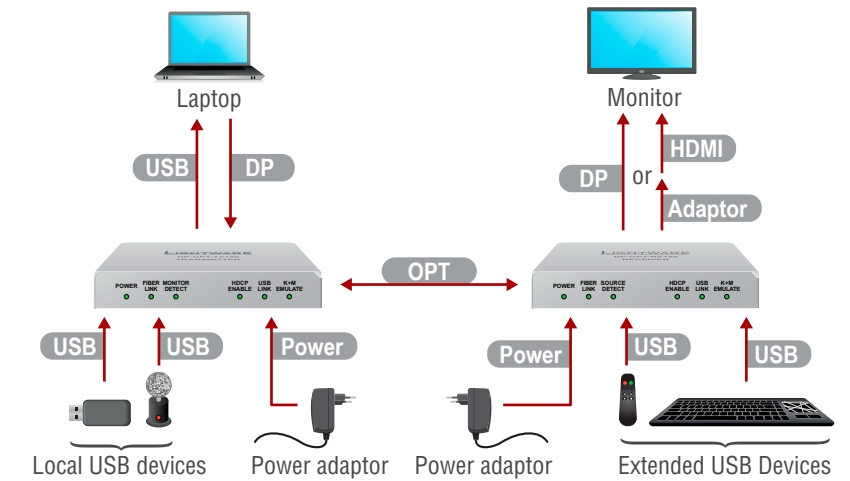

- DP** Connect the desired source to the **DP input** port of the **transmitter**.
- USB** Connect the supplied **USB cable** between the transmitter and a computer to extend USB HID devices, to connect local USB devices, and/or to control the extenders by LDC.
- USB** Connect the desired **local USB devices** to the Transmitter and USB HID devices to the Receiver for USB KVM extension.
- DP Adaptor** Connect a **DP sink device** to the Receiver by a DP cable or an HDMI sink device by an HDMI cable and a DP/HDMI adaptor cable.
- OPT** Connect a multimode **fiber optical cable** between the Transmitter and the Receiver.
- POWER** Connect the **power adaptor** to the DC input on the receiver first, then to the AC power socket or use Lightware's rack-mountable Power Supply Units.

2.3. Security slot

A Kensington-compatible security slot can be found on the side of the units for theft protection. (Security cable is not supplied with the extenders.)

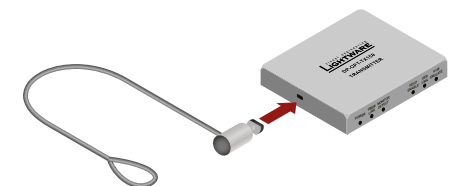

3

Product Overview

The following sections are about the physical structure of the device, input/output ports and connectors:

- ▶ [DP-OPT-TX150](#)
- ▶ [DP-OPT-RX150](#)
- ▶ [ELECTRICAL CONNECTIONS](#)

3.1. DP-OPT-TX150

Front View

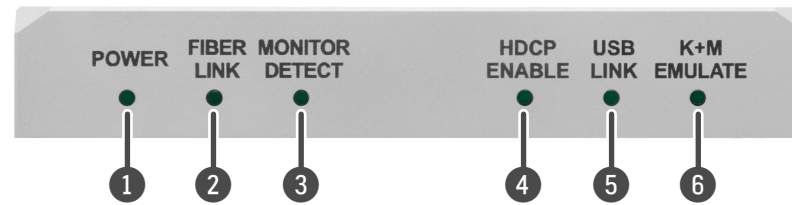

1 POWER LED

- **ON:** the unit is powered on.
- **BLINKING:** an error has occurred and device is out of normal operation, or it is in bootload mode (during firmware upgrade).

2 FIBER LINK LED

- **ON:** the link is active between the extenders and ready to use.
- **BLINKING:** is no connection between the extenders.

3 MONITOR LED

- **ON:** a sink device is connected to the output port of the receiver.

4 HDCP LED

- **ON:** DP signal transmission is in progress or HDCP encryption is enabled during DVI/HDMI transmission.
- **OFF:** a DVI or HDMI display is connected to the receiver (via an adaptor cable) and HDCP is disabled (thus the source is forced to send non-encrypted stream). For more information about the HDCP setting, see the [HDCP Setting](#) section.

5 USB LINK LED

- **ON:** HID extension is active.
- **BLINKING:** the USB channel is ready to use but HID extension is not active (e.g. there is no USB HID device connected to the receiver or the computer is powered off).
- **OFF:** the USB channel between the extenders is not ready.

6 K+M EMULATE LED

- **OFF:** the transmitter is in transparent USB mode (default).
- **BLINKING:** the transmitter is in configuration USB mode; see the [USB Modes](#) section for more information.

Rear View

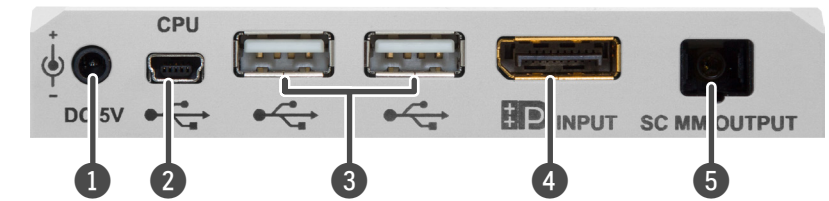

1 DC Connector

Connect the output of the supplied +5 V power adaptor. Lightware's rack mountable power supply can also be used (PSUx10-200 or PSUx20-400).

2 Local USB Ports

The transmitter has a built-in USB HUB. These local USB 2.0 ports can be used as extra USB ports connected to your computer but without extension.

3 DisplayPort Input

DisplayPort 1.1a input connector. Applied cable shall not be more than 2 m. See the [DP Input and Output Ports](#) section for more information about the connector.

4 USB Connector

USB mini-B type connector. Connect to the computer if USB HUB or USB KVM (HID) features are used. Control functions (with Lightware Device Controller) and firmware upgrade are also performed through this connector.

5 SC Fiber Connector

SC fiber optical output connector. Connect to the receiver by a multimode fiber cable.

3.2. DP-OPT-RX150

Front View

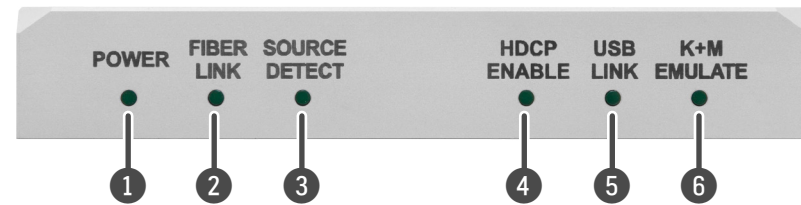

1 POWER LED

- **ON:** the unit is powered on.
- **BLINKING:** an error has occurred and device is out of normal operation, or it is in bootload mode (during firmware upgrade).

2 FIBER LINK LED

- **ON:** the link is active between the extenders and ready to use.
- **BLINKING:** is no connection between the extenders.

3 SOURCE LED

- **ON:** powered DP source is connected to the transmitter.
- **BLINKING:** an HDMI adaptor cable is connected to the receiver to indicate HDMI mode operation.

4 HDCP LED

- **ON:** DP signal transmission is in progress or HDCP encryption is enabled during DVI/HDMI transmission.
- **OFF:** a DVI or HDMI display is connected to the receiver (via an adaptor cable) and HDCP is disabled (thus the source is forced to send non-encrypted stream). For more information about HDCP setting, see the [HDCP Setting](#) section.

5 USB LINK LED

- **ON:** HID extension is active.
- **BLINKING:** the USB channel is ready to use but HID extension is not active (e.g. there is no USB HID device connected to the receiver or the computer is powered off).
- **OFF:** the USB channel between the extenders is not ready.

6 K+M EMULATE LED

- **OFF:** the transmitter is in transparent USB mode (default).
- **BLINKING:** the transmitter is in configuration USB mode.

Rear View

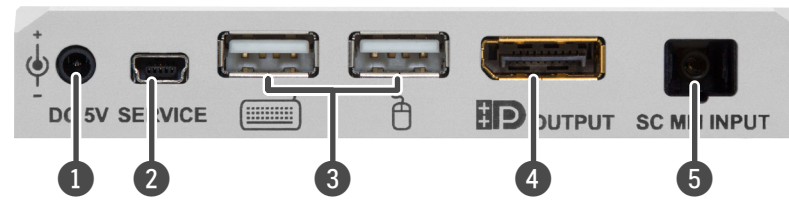

1 DC Connector

Connect the output of the supplied +5 V power adaptor. Lightware's rack mountable power supply can also be used (PSUx10-200 or PSUx20-400).

2 USB Ports

Ports for USB HID (Human Interface Device, e.g. mouse, keyboard, or presenter) and USB HUB devices (e.g. keyboard with built-in USB HUB). Only HID devices are extended to the source computer. (The symbols are just recommendations; mouse can be plugged into the port indicated with keyboard-symbol and vice versa.)

3 DisplayPort Output

DisplayPort 1.1a output connector for display devices with DisplayPort connector. The applied DP-DP cable shall not be more than 2 m. DP adapters with DVI or HDMI connector are also supported. See the [DP Input and Output Ports](#) section for more information about the connector.

4 USB Connector

USB mini-B type connector for control functions (with Lightware Device Controller) and firmware upgrade.

5 SC Fiber Connector

SC fiber optical input connector. Connect to the transmitter by a single multimode fiber cable.

3.3. Electrical Connections

3.3.1. Fiber Optical Connector

The extenders are assembled with standard SC receptacles.



3.3.2. DP Input and Output Ports

DP-OPT-TX150 and DP-OPT-RX150 provides DisplayPort connectors with Dual-mode support. When a passive adapter is connected to the receiver, the source device is forced to switch to DVI/HDMI mode.



3.3.3. USB Connectors

Standard USB connectors are built in the extenders supporting different features, but the pinout of the connectors are the same.



4

Operation

This chapter is about the powering and operating of the device describing the video and USB functions:

- ▶ POWERING ON
- ▶ USB MODES
- ▶ HDCP SETTING
- ▶ DP MODE AND HDMI MODE

4.1. Powering On

ATTENTION! When building an electronic system, make sure that all of the devices are powered down before connecting them. Powered on devices may have dangerous voltage levels which can damage sensitive electronic circuits.

After the system is complete, connect the DC power cable to the extender unit and then to the power outlet. The unit is immediately powered ON.

After the extender units are initialized, the attached DP source and monitor can be powered on.

ATTENTION! If the power LED does not light up upon power-up, the unit is most likely damaged and further use is not advised. Please contact support@lightware.com.

INFO: The laser becomes enabled any time the transmitter is powered on. This is done to avoid accidental laser loss problems.

4.1.1. Setting up USB Devices

DP-OPT-RX150 handles USB HID devices (Human Interface Device), which are input devices like mouse, keyboard, presenter, pointing device, etc. However USB HUBs are supported (like those keyboards, monitors that have built-in USB HUB), only two devices are available for extension at the same time.

When the transmitter is connected to the computer by the USB cable, it can be used as a local USB 2.0 HUB. To build the USB connection, do the following steps:

Step 1. Connect the supplied USB cable to the transmitter's mini USB connector.

Step 2. Connect the other end of the USB cable into an empty USB slot on the computer.

Step 3. Connect the HID device(s) to the receiver.

INFO: If the previously used USB devices are connected through the extenders to the computer, they may be handled as new hardware by the operating system at the first time.

4.2. USB Modes

Two channels are used for the USB communication between the extenders. Channel A1 is always transparent and one USB HID device is always operable. The other channel's state can be set which determines the current USB mode.

Transparent USB Mode

Both channels are available for USB HID devices connected to the receiver. Default setting is transparent USB mode which means both USB HID devices connected to the receiver are transparently transmitted to the source computer.

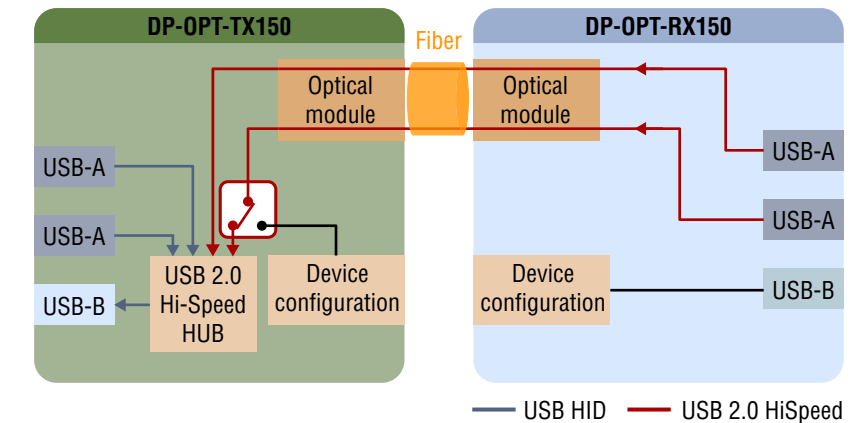

USB channels in Transparent mode

Configuration USB Mode

Configuration USB mode is an option where the extenders' USB settings can be configured by using the Lightware Device Controller. One channel (A1) is available for a USB HID device, the other channel (A2) is reserved for communication.

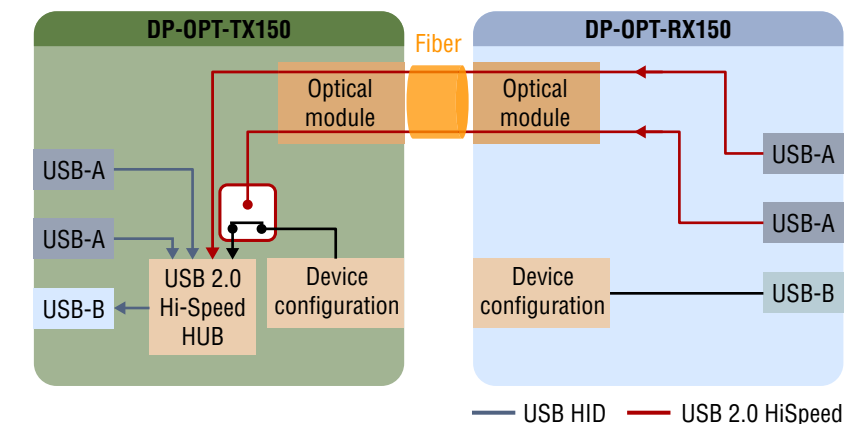

USB channels in Configuration mode

INFO: The USB mode has an effect only on the transmitter's state. Receiver is always in configuration mode. Setting the USB mode on the receiver effects only the transmitter.

4.2.1. Changing the USB Mode

The USB mode can be changed in the transmitter or in the receiver but in latter case make sure that the extenders are linked by the fiber cables.

ATTENTION! If the USB mode is changed in the receiver when the extenders are not connected by fiber cable, the setting is store in the receiver and the USB mode will be changed after reconnecting.

Step 1. Power ON the extender(s) and locate the hidden function button on the bottom side.

Step 2. Press and keep pressed the button by a thin tool (e.g. paper clip) for about two seconds. Release the button not more than five seconds.

Step 3. The current USB mode is visible on the front panel.

ATTENTION! When the configuration mode is active, only one USB HID device can be used: the one that was connected to the receiver at first.

INFO: Default setting (transparent mode) is restored when the device is powered on.



4.3. HDCP Setting

When a non-HDCP compatible sink is connected to the receiver, the source can be forced to output non-encrypted signal if the content is not protected. For more information about the HDCP management, see the [HDCP Management](#) section.

HDCP is enabled as a default setting but can be changed as follows:

Step 1. Locate the hidden function button on the bottom side of the extender (either on TX150 or RX150).

Step 2. Press and keep pressed the hidden function button by a thin tool (e.g. paper clip) for at least 10 seconds (pressing the button for a shorter period changes the USB mode instead). If the extenders are in HDMI mode the 'HDCP enable' LED status is changed before releasing the button.



ATTENTION! The HDCP setting can be changed in DP mode, but in this case the 'HDCP enable' LED will not show the change. The setting will be effective only after switching to HDMI mode. In DP mode HDCP is always enabled.

INFO: The HDCP setting is available in both extenders.

4.4. DP Mode and HDMI Mode

The extenders work in two modes according to the connected display device:

DisplayPort Mode (DP-DP cable)

When the DP output port of the transmitter is connected to the DP input port of the display device, the extenders are in DP mode. In this case the source sends DP signal.

Display is Connected by a DVI/HDMI Passive Adaptor

When the DP output port of the transmitter is connected to the DVI/HDMI port of the display device through a passive adaptor, the extenders and the source are in HDMI mode. In this case the source sends DVI/HDMI signal. See more information about the Dual mode in the [HDCP Setting](#) section.

5

Software Control - Lightware Device Controller Software

The extenders can be controlled by a computer through the USB port using Lightware Device Controller (LDC). The software can be installed on a Windows PC or Mac OS X. The application can be downloaded from www.lightware.com. The Windows and the Mac versions have the same look and functionality.

- ▶ [INSTALL AND UPGRADE](#)
- ▶ [CONNECTING TO A DEVICE \(DEVICE DISCOVERY WINDOW\)](#)
- ▶ [CONTROL MENU](#)
- ▶ [REAL-LIFE EXAMPLES \(USB DEVICES AND MODES\)](#)
- ▶ [TERMINAL MENU](#)
- ▶ [SETTINGS MENU](#)

5.1. Install and Upgrade

INFO: After the installation, the Windows and the Mac application has the same look and functionality. This type of the installer is equal with the Normal install in the case of Windows and results an updateable version with the same attributes.

Installation for Windows OS

Run the installer. If the User Account Control drops a pop-up message click Yes. During the installation you will be prompted to select the type of the installation: normal and the snapshot install:

Normal install	Snapshot install
Available for Windows and Mac OS X	Available for Windows
The installer can update only this instance	Cannot be updated
Only one updateable instance can exist for all users	More than one different version can be installed for all users

Comparison of the Installation Types

ATTENTION! Using the Normal install as the default option is highly recommended.

Installation for Mac OS X

Mount the DMG file with double clicking on it and drag the LDC icon over the Applications icon to copy the program into the Applications folder. If you want to copy the LDC into another location just drag the icon over the desired folder.

The Upgrading of the LDC

Step 1. Run the application.

The **Device Discovery** window appears automatically and the program checks the available updates on Lightware's website and opens the update window if the LDC found updates. The current and the update version number can be seen at the top of the window and they are shown in this window even with the snapshot install. The **Update** window can be also opened by clicking the **?** (About) and the **Update** button.

Step 2. Set the desired update setting in the **Options** section.

When the Check for updates automatically option is selected, the LDC tries to find a new version after startup. The update can be postponed by setting a reminder; use the drop down list. The proxy settings can be set in a separate window.

Step 3. Click the **Download update** button to start. The updates can be checked manually by clicking the **Check now** button.

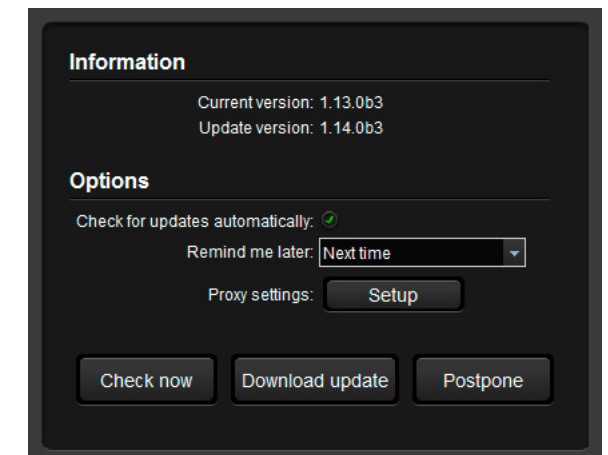

TIPS AND TRICKS: To get the best visibility of the screenshots in this chapter adjust the zoom setting of your PDF Reader software to 150% magnification.

5.2. Connecting to a Device (Device Discovery Window)

There are three tabs for the different type of interfaces: Ethernet, Serial, and USB. Select the **USB** tab to connect to the desired extender.

Establishing the Connection

Double click on the device or select it and click on the green **Connect** button. Please note that if you connect to the **Transmitter** directly, it must be in **Configuration** mode.

5.3. Control menu

The Control menu shows basic information about the extender(s) in three panels. The **Connected** text is displayed in the extender's title that is connected to the computer directly.

Parameter	State and Description
Fiber link	Connected: Transmitter and Receiver are linked Disconnected: no fiber connection
DP link speed and channels	According to the incoming signal (only in DP mode)
Video mode	DisplayPort HDMI: passive adaptor is connected to the receiver
Video source state	ON: source is present in DP mode Not connected: source is not connected n/a: no information about the signal (HDMI mode)
Monitor state	ON: DP or HDMI display OFF: display device is not connected
HDCP enable	checked: HDCP enabled unchecked: HDCP disabled

5.3.1. Video and Link Panel

Basic information is displayed about the extenders and the video signal. If the extenders are linked by fiber cable, they can read information about each other and display.

INFO: Source can be forced to send unencrypted signal (if the content allows) by unchecking the **HDCP enable** setting.

INFO: **HDCP enable** setting can be changed in DP and HDMI mode also, but effects only when DVI/HDMI adaptor is connected. When HDCP is changed in DP mode, the setting is stored and will be applied when an adaptor is connected.

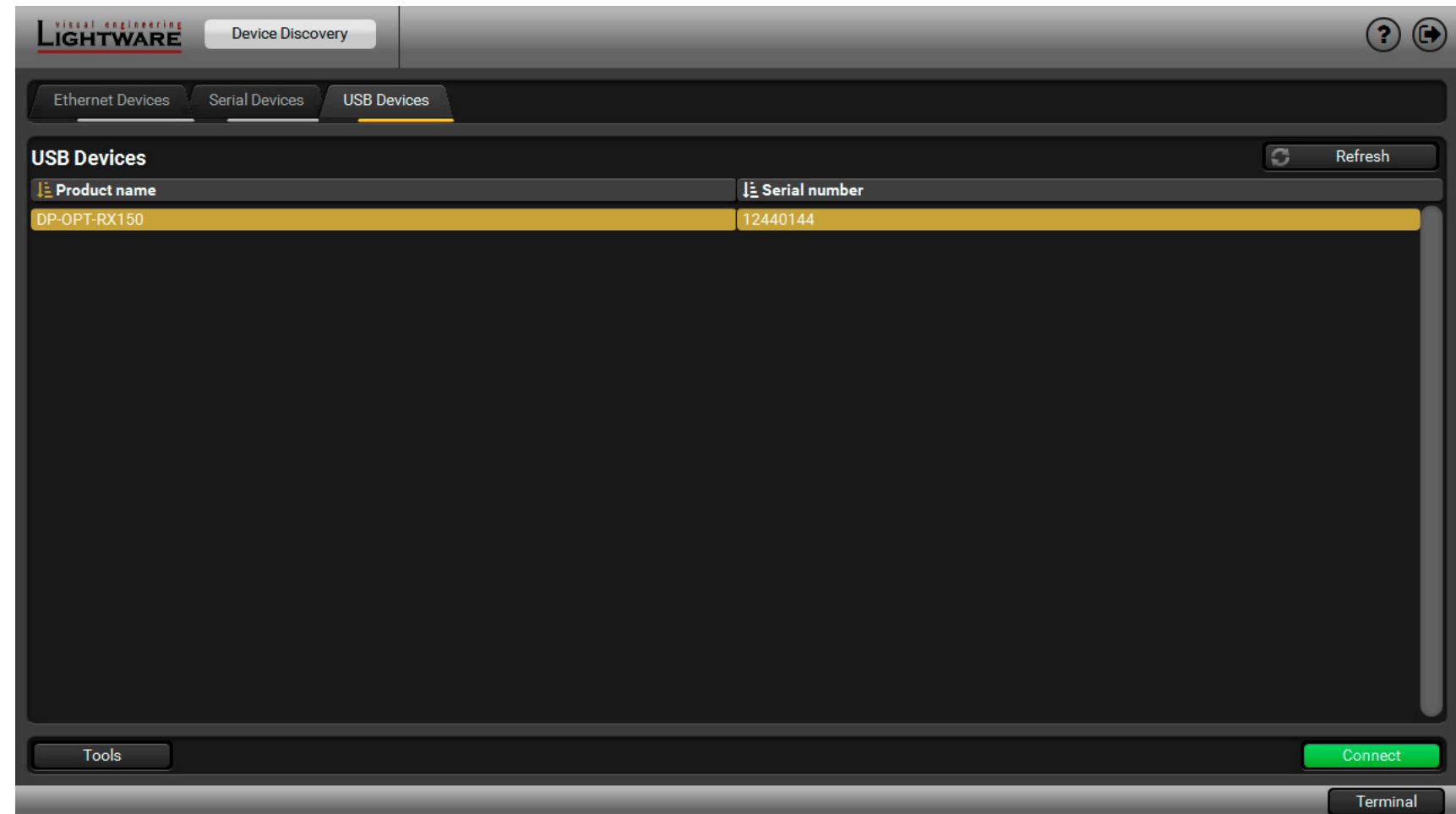

The Device Discovery Window

5.3.2. Transmitter Panel

Two channels are used for the USB communication, which can be set as described in the [USB Modes](#) section. Channel 1 is always transparent, Channel 2 can be set to transparent or configuration mode.

Parameter	State and Description
USB host (computer)	Connected
USB Channel 1 mode	Transparent (always)
USB Channel 1 state	Active Not connected (it depends on the HID devices)
USB Channel 2 mode	Configuration Transparent
USB Channel 2 status	Active

ATTENTION! USB Channel 2 mode can be changed by a drop-down menu. When switched to transparent mode, the extender is disconnected from the LDC immediately.

The screenshot displays the 'Control' menu of the Lightware software. At the top, there are navigation tabs for 'USB', 'DP-OPT-RX150', and '12440144'. Below this, the interface is divided into several sections:

- Status Section:** Shows 'Fiber link: Connected', 'DP Link speed: Unknown', 'DP Link channels: Unknown', 'HDCP enable: [checked]', 'Video mode: DisplayPort', 'Video source state: Not connected', and 'Monitor state: Not connected'.
- DP-OPT-TX150 Section:** Lists settings for the transmitter: 'USB host (Computer): Not connected', 'USB Channel 1 mode: Transparent', 'USB Channel 1 state: Not connected', 'USB Channel 2 mode: Transparent' (with a dropdown arrow), and 'USB Channel 2 state: Not connected'.
- DP-OPT-RX150 (Connected) Section:** Contains a table for 'Connected USB devices' and a section for 'Blocked USB devices'.

Manufacturer	Product	Type	Ch	Status	VID	PID	Addr
MOON	AND	HID Mouse	A2	Active	13EE	0001	2
SEM	USB Keyboard	HID Keyboard	A1	Active	1A2C	2124	104

ID	Name	VID	PID
1	-	-	-
2	-	-	-
3	-	-	-
4	-	-	-
5	-	-	-
6	-	-	-
7	-	-	-

At the bottom right, there is a 'Terminal' button.

The Control Menu

5.3.3. Receiver Panel

The panel consists of the lists that are showing connected and blocked USB devices.

Connected USB Devices



The listed devices are connected to the receiver's USB ports.

DP-OPT-RX150 (Connected)							
Connected USB devices							
Manufacturer	Product	Type	Ch	Status	VID	PID	Addr
Kingston	-	Unknown	-	Not supported	0951	1666	1
SEM	USB Keyboard	HID Keyboard	A1	Active	1A2C	2124	2

Parameters

Parameter	State and Description
Manufacturer, Product, Type	As coded in the USB device.
CH (Channel)	Channel A1 and A2 are used for USB communication. A1 is always transparent, A2 can be switched. The USB device on Channel A1 was connected to the receiver the earliest.
Status	Active: the device is ready to use in transparent mode. Supported: the device is supported, but not active (no channel is available for extension). Unsupported: the device is not USB HID (e.g. pen drive).
VID, PID	Vendor ID and Product ID as coded in the USB device.
Address	See the following section.

The Address of the Device

Address of the device plugged in  = 1 and the device plugged in  in = 2. Since USB HUB can be connected to the receiver, the addresses are determined as follows:

- Address of the USB HUB: 100 (not visible)
- Address of the USB device connected to the first port of the USB HUB: 104

DP-OPT-RX150 (Connected)							
Connected USB devices							
Manufacturer	Product	Type	Ch	Status	VID	PID	Addr
MOON	AND	HID Mouse	A2	Active	13EE	0001	2
SEM	USB Keyboard	HID Keyboard	A1	Active	1A2C	2124	104

Above example shows a mouse that is connected to the USB port (Ch A1, Addr 2). The other device is a keyboard, which is connected via an USB HUB – that is why its address is not 1 but 101. Since the extenders are in configuration mode, only one device can be used: the one on channel A1 (the mouse).

However USB HUBs are supported by the receiver, only two devices are active at the same time in transparent mode: the devices which are closest to the root address. If an active device is disconnected, the next valid device (that is the closest to the root) will be active.

INFO: Channel A1 and A2 are assigned to the devices automatically when a new device is connected.

Port Numbers

The port numbers of the USB HUB determines the priority of the devices. When more devices are connected to an USB HUB, the USB port number determines the priority of the connected devices: the lower number, the higher priority. This priority has an effect when the channels are assigned to the devices.

Blocked USB Devices

The USB blocking feature allows you to activate the desired devices when more than two USB HID devices are connected to the receiver (two channels are available for USB extension). A typical example is shown in the [Example 3: Connecting three USB HID devices and a HUB](#) section.

Blocking a Device

Step 1. Click on the **Block manually** button, or select a device from the **Connected USB devices** list and click on **Block selected** button.

Step 2. Check the fields in the appearing window (Device name, Vendor ID, Product ID) and click on **Save** button. The ID is the number of the blocked device in the list.

Step 3. Click the **Apply** button in the bottom of the window to save changes. The desired device is added to the **Blocked USB devices** list and next time when you connect it to the receiver, its status will be displayed as **Blocked**.

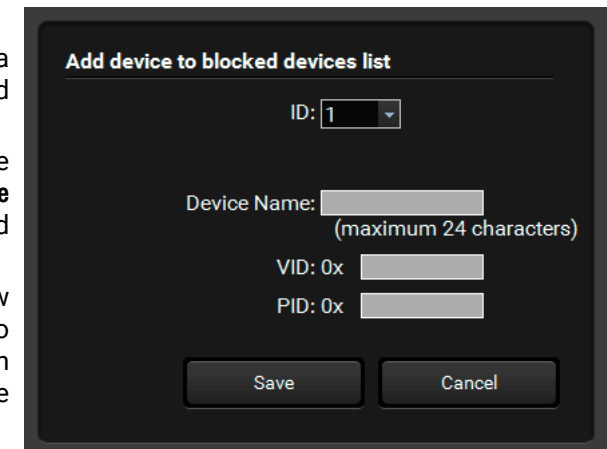

Removing blocked devices

Step 1. Select the device from the **Blocked USB devices** list.

Step 2. Click on **Remove** button.

Step 3. Click on **Apply** button on the bottom of the screen to save changes.

INFO: The **Remove all** button will empty the list of blocked devices.

5.4. Real-life examples (USB devices and modes)

The background of the USB modes, connected USB devices, displayed information can be understood easier by presenting examples.

Example 1: Connecting Two USB HID Devices

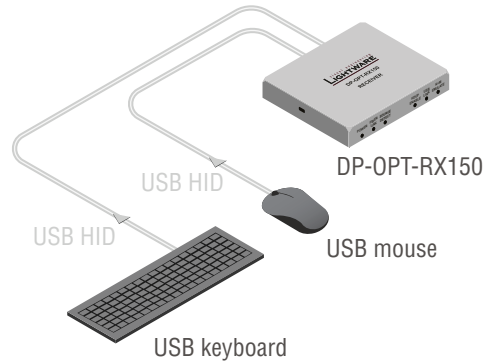

Device tree structure:
 Root
 └ 1 (Keyboard)
 └ 2 (Mouse)

Shown in the LDC:

DP-OPT-RX150 (Connected)							
Connected USB devices							
Manufacturer	Product	Type	Ch	Status	VID	PID	Addr
MOON	AND	HID Mouse	A2	Active	13EE	0001	1
SEM	USB Keyboard	HID Keyboard	A1	Active	1A2C	2124	2

In a simple case a keyboard and a mouse are connected to the receiver.

In **Transparent** mode both devices are operable.

In **Configuration** mode only one of them is available (as seen on the screenshot), the keyboard on channel A1. The second row (the mouse) is blinking, showing that the device is not available.

Example 2: Connecting Two USB HID Devices via an USB HUB

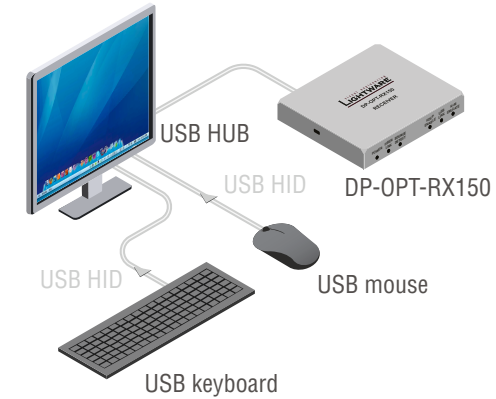

Device tree structure:
 Root
 └ 100 (USB HUB)
 └ 103 (Keyboard)
 └ 104 (Mouse)

Shown in LDC:

DP-OPT-RX150 (Connected)							
Connected USB devices							
Manufacturer	Product	Type	Ch	Status	VID	PID	Addr
SEM	USB Keyboard	HID Keyboard	A1	Active	1A2C	2124	103
MOON	AND	HID Mouse	A2	Active	13EE	0001	104

This case is similar than the first, but now the mouse and the keyboard are connected to a local USB HUB. The HUB (with 4 available USB ports) is built into the monitor and connected to the receiver (the address of the HUB is 200). The keyboard is connected to the 2nd port (Addr. 202) and the mouse is connected to the 4th port of the HUB (Addr. 204).

In **Transparent** mode both devices are operable.

In **Configuration** mode only one USB HID device is available (as seen on the screenshot), the keyboard on channel A1. The second row (the mouse) is blinking, showing that the device is out of operation currently – due to the USB mode.

Example 3: Connecting three USB HID devices and a HUB

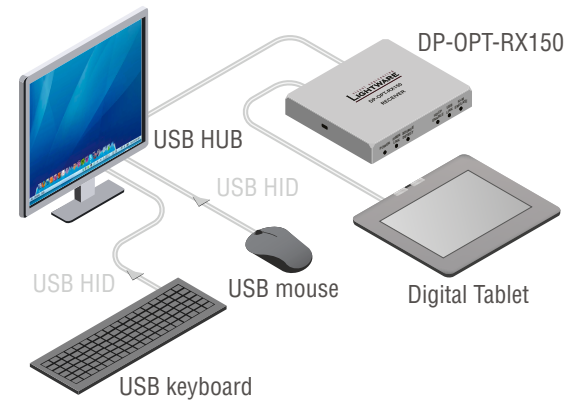

Device tree structure:
 Root
 | 2 (Digital Tablet)
 | 100 (USB HUB)
 | | 103 (Keyboard)
 | | 104 (Mouse)

Shown in LDC:

DP-OPT-RX150 (Connected)							
Connected USB devices							
Manufacturer	Product	Type	Ch	Status	VID	PID	Addr
WACOM	CTE-640-U V4	HID Mouse	A2	Active	056A	0016	2
SEM	USB Keyboard	HID Keyboard	A1	Active	1A2C	2124	103
MOON	AND	HID Mouse	-	Supported	13EE	0001	104

On the third example three USB devices can be seen. A mouse and a keyboard are connected to the USB HUB that is connected to one of the receiver's USB port. A presenter device is connected to the other USB port (the presenter is listed as "Keyboard").

In **Transparent mode** two devices are operable: the presenter (on channel A1) and the keyboard (on channel A2). The presenter was connected to the receiver the earliest, that is why channel A1 is assigned to the presenter. The address number of the keyboard is lower than the mouse, that is why channel A2 is assigned to the keyboard. If you want to use the mouse, you have to block the presenter or the keyboard (the other option is to disconnect one of them).

In **Configuration mode** only one device is operable: the presenter on channel A1. Second row (the keyboard) is blinking, showing the device is not available – due to the USB mode.

INFO: Channel A1 and A2 are assigned to the devices automatically when a new device is connected; they cannot be changed manually.

INFO: The port numbers of the USB HUB determines the priority of the devices. When more devices are connected to an USB HUB, the USB port number determines the priority of the connected devices: the lower number, the higher priority. This priority has an effect when the channels are assigned to the devices.

Example 4: Using an Apple LED cinema display

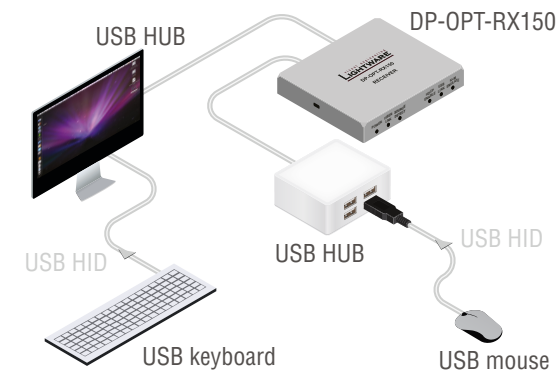

Device tree structure:
 Root
 | 100 (USB HUB - built in the Display device)
 | | 101 (Mouse)
 | | 104
 | | 105
 | | 106
 | 200 (USB HUB)
 | | 204 (Keyboard)

Shown in LDC:

DP-OPT-RX150							
Connected USB devices							
Manufacturer	Product	Type	Ch	Status	VID	PID	Addr
Logitech	-	Mouse	A1	Active	046D	C05A	101
Apple Inc.	-	-	A2	Active	05AC	1105	104
Apple Inc.	-	-	-	Not supported	05AC	8508	105
Apple Inc.	-	-	-	Supported	05AC	9226	106
-	USB Keyboard	Keyboard	-	Supported	0461	0010	204

The last example shows a special layout, where an Apple LED cinema display (with built-in USB HUB), a mouse, a keyboard and another simple USB HUB are installed. The layout could cause headache, since the display contains three components which report themselves as HID devices. The result is that the keyboard's address is lower than the components in the display device and the keyboard will be operable neither in configuration-, nor in transparent mode.

The solution in this case is to block the unnecessary devices, shown in the 2nd and 4th rows. (The device in the 3rd row is not supported, it is not necessary to block.) Block the two devices:

DP-OPT-RX150							
Connected USB devices							
Manufacturer	Product	Type	Ch	Status	VID	PID	Addr
Logitech	-	Mouse	A1	Active	046D	C05A	101
Apple Inc.	-	-	-	Blocked	05AC	1105	104
Apple Inc.	-	-	-	Not supported	05AC	8508	105
Apple Inc.	-	-	-	Blocked	05AC	9226	106
-	USB Keyboard	Keyboard	A2	Active	0461	0010	204

Thus in **Transparent mode** the mouse and the keyboard will be operable.

In **Configuration mode** only the mouse is available, that is why the last row is blinking.

5.5. Terminal Menu

The general purpose of this serial terminal is intended mainly for testing and debugging purposes. Nevertheless, when the window is open, the automatically executed commands can be followed on the screen.

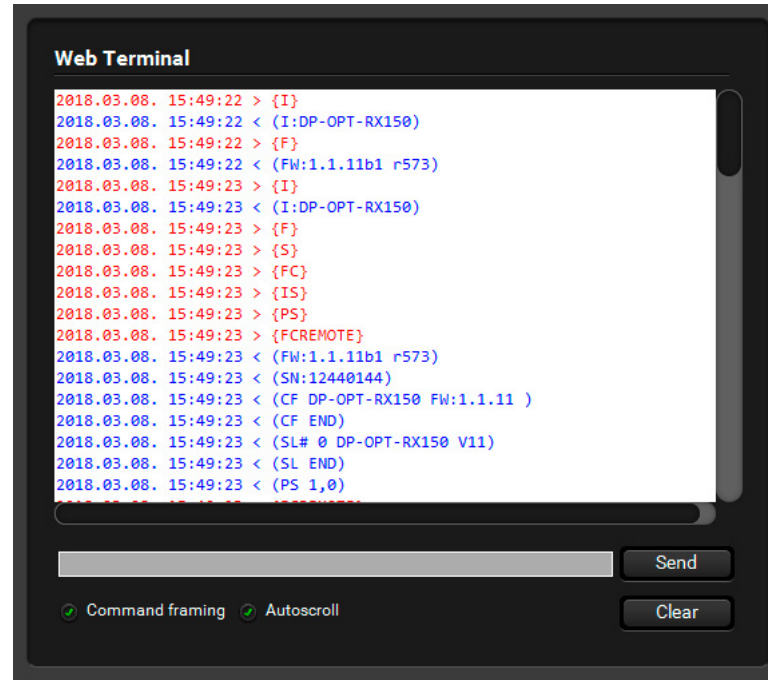

```

Web Terminal
2018.03.08. 15:49:22 > {I}
2018.03.08. 15:49:22 < (I:DP-OPT-RX150)
2018.03.08. 15:49:22 > {F}
2018.03.08. 15:49:22 < (FW:1.1.11b1 r573)
2018.03.08. 15:49:23 > {I}
2018.03.08. 15:49:23 < (I:DP-OPT-RX150)
2018.03.08. 15:49:23 > {F}
2018.03.08. 15:49:23 < {S}
2018.03.08. 15:49:23 > {FC}
2018.03.08. 15:49:23 < {IS}
2018.03.08. 15:49:23 > {PS}
2018.03.08. 15:49:23 < {FCREMOTE}
2018.03.08. 15:49:23 < (FW:1.1.11b1 r573)
2018.03.08. 15:49:23 < (SN:12440144)
2018.03.08. 15:49:23 < (CF DP-OPT-RX150 FW:1.1.11 )
2018.03.08. 15:49:23 < (CF END)
2018.03.08. 15:49:23 < (SL# 0 DP-OPT-RX150 V11)
2018.03.08. 15:49:23 < (SL END)
2018.03.08. 15:49:23 < (PS 1,0)
  
```

Terminal Window

5.6. Settings menu

5.6.1. Device information

Basic information about the extender, such as type, serial number, firmware and hardware revisions are displayed on this tab.

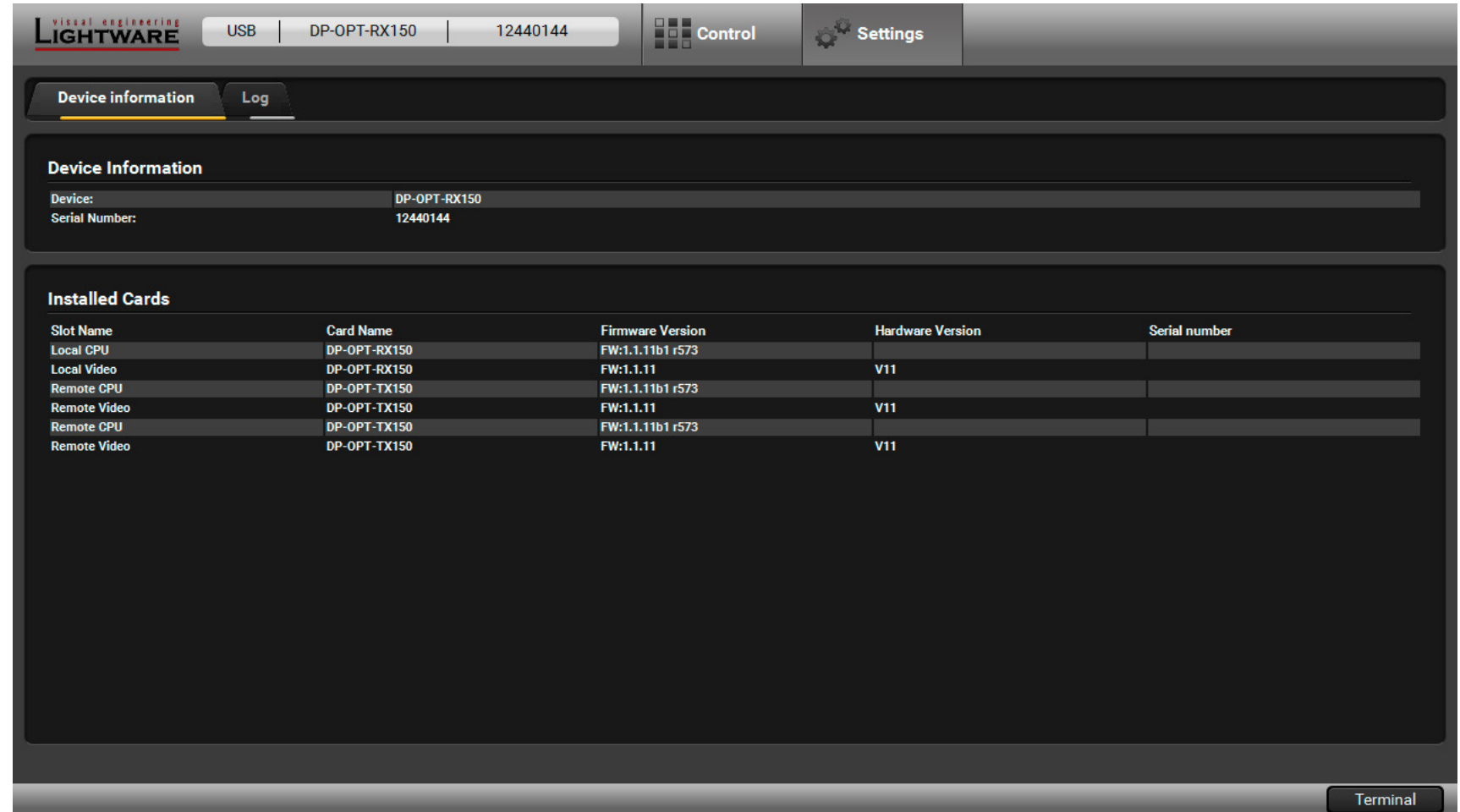

Slot Name	Card Name	Firmware Version	Hardware Version	Serial number
Local CPU	DP-OPT-RX150	FW:1.1.11b1 r573		
Local Video	DP-OPT-RX150	FW:1.1.11	V11	
Remote CPU	DP-OPT-TX150	FW:1.1.11b1 r573		
Remote Video	DP-OPT-TX150	FW:1.1.11	V11	
Remote CPU	DP-OPT-TX150	FW:1.1.11b1 r573		
Remote Video	DP-OPT-TX150	FW:1.1.11	V11	

The Device Information Tab

5.6.2. Log Tab

Generate Report

LDC is able to collect information from the extender and save it to a report file. This information package can be sent to Lightware support team when a problem may arise with the extender.

ATTENTION! When a report is necessary to generate, always let devices (source, sink) be connected to the extenders, do not disconnect them. Lightware Device Controller will collect information about the USB devices and about their status.

Step 1. Press the big red **Download report** labeled button on the **Log tab** in **Settings** menu.

Step 2. LDC collects the needed information in a minute.

Step 3. When the process is finished, the **Save as** dialog box appears. Select the place where you want to save the report file. The default file name can be changed.

The report contains the following information:

- Current command protocol
- The equipment type and serial number
- Firmware version of the controller
- Installed I/O board type and version

Generating a Custom Report File

INFO: This function is only for special troubleshooting cases.

Device Controller is able to send a custom command file to the extender. The command file can be generated by Lightware support. This is needed when some special commands has to be used for configuring or troubleshooting.

The screenshot shows the Lightware Device Controller software interface. At the top, there is a navigation bar with the Lightware logo and several tabs: 'USB', 'DP-OPT-RX150', and '12440144'. To the right of these tabs are 'Control' and 'Settings' buttons. Below the navigation bar, there are two tabs: 'Device information' and 'Log'. The 'Log' tab is active and contains a 'Report' section with a large red 'Download report' button and a 'Generate report from file' button. Below the 'Report' section is the 'Log viewer' section. It has a 'Select a month' dropdown set to '1970 / 01' and a 'Select day' dropdown set to '1'. There are also 'View mode' buttons for 'User Information' (which is highlighted) and 'Debug', and a 'Save LOG' button. The log viewer displays a table with the following columns: 'Nr', 'Level', 'Time', 'Code', and 'User Information'. The table contains several entries, with some rows highlighted in yellow. At the bottom of the log viewer, there is a yellow warning bar that says 'Hashed rows are possible power off transient events.' Below the log viewer, there are 'Delete all logs' and 'Delete this log' buttons. At the bottom right of the interface, there is a 'Terminal' button.

Nr	Level	Time	Code	User Information
2	Notice	01.01.1970.00:02:11 UTC+0000	FW_INFO	
3	Notice	01.01.1970.00:02:11 UTC+0000	FW_INFO	
4	Notice	01.01.1970.00:02:11 UTC+0000	FW_INFO	
6	Notice	01.01.1970.00:04:08 UTC+0000	BOOT	Matrix booted from . Initialized the motherboard (Compiled: Feb 25 2014 12:45:53 Build:0)
7	Notice	01.01.1970.00:00:00 UTC+0000	BOOT	Matrix booted from . Initialized the motherboard (Compiled: Feb 25 2014 12:45:53 Build:0)
9	Notice	01.01.1970.00:00:00 UTC+0000	BOOT	Matrix booted from . Initialized the motherboard (Compiled: Feb 25 2014 12:45:53 Build:0)
11	Notice	01.01.1970.18:13:57 UTC+0000	BOOT	Matrix booted from . Initialized the motherboard (Compiled: Feb 25 2014 12:45:53 Build:0)

The Log Tab

6

Firmware Upgrade

The extenders can be upgraded by using Lightware Device Updater (LDU) software via the USB port. The application and the User's manual can be downloaded from www.lightware.com. In order to get the firmware pack with the necessary components (*.lfp file) for your specific product, please contact support@lightware.com.

- ▶ [ABOUT THE FIRMWARE PACKAGE \(LFP FILE\)](#)
- ▶ [SHORT INSTRUCTIONS](#)
- ▶ [INSTALL AND UPGRADE](#)
- ▶ [DETAILED INSTRUCTIONS](#)

ATTENTION! While the firmware is being upgraded, the normal operation mode is suspended as the receiver is switched to bootload mode. Signal processing is not performed. Do not interrupt the firmware upgrade. If any problem occurs, reboot the receiver and restart the process.

6.1. About the Firmware Package (LFP File)

The firmware files are packed in an LFP package. You need only this file to do the upgrade on your device.

- The package contains all the necessary components, binary, and other files; You do not have to get further files.
- There is a descriptor file in the package that contains each firmware with version number and a list showing the compatible devices. The descriptor is displayed after loaded the LFP file in the LDU.

6.2. Short Instructions

Step 1. Get the firmware pack and the Lightware Device Updater (LDU) application.

Step 2. Install the LDU application.

Step 3. Establish the connection between the computer and the device(s).

Step 4. Start the LDU and follow the instructions shown on the screen.

6.3. Install and Upgrade

Installation for Windows OS

INFO: The application can be installed under Windows XP or above.

Run the installer. If the User Account Control drops a pop-up message click **Yes**. During the installation you will be prompted to select the type of the installation:

Normal install	Snapshot install
Available for Windows and Mac OS X	Available for Windows
The installer can update only this instance	Cannot be updated
Only one updateable instance can exist for all users	More than one different version can be installed for all users

Comparison of install types

ATTENTION! Using the Normal install as the default value is highly recommended.

Installation for Mac OS X

INFO After the installation the Windows and the Mac application has the same look and functionality. This type of the installer is equal with the Normal install in case of Windows and results an updateable version with the same attributes.

Mount the DMG file with double clicking on it and drag the LDU icon over the Applications icon to copy the program into the Applications folder. If you want to copy the LDU into another location just drag the icon over the desired folder.

LDU Upgrade

Step 1. Run the application. In the welcome screen click on the  button in the top right corner; the About window will appear. Click on the **Check now** button. The program checks the available updates on Lightware website and shows its version.

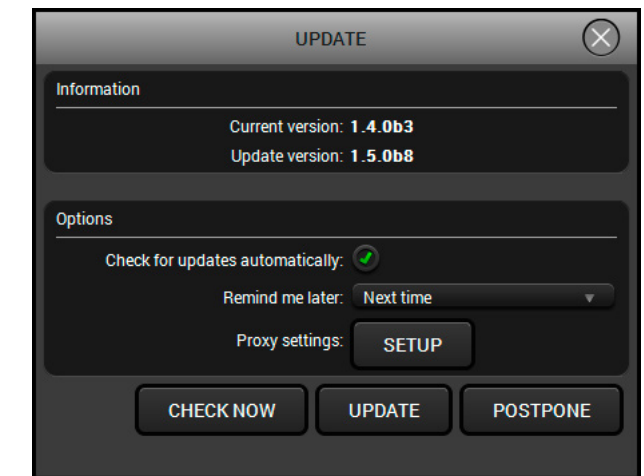

Step 2. Set the desired update settings in the **Options** section.

- If you do not want to check for the updates automatically, uncheck the **circle**, which contains the green tick.
- If you want to postpone the update, a reminder can be set with different delays from the **drop down list**.
- If the proxy settings traverse the update process, set the proper values then click the **OK** button.

Step 3. Press the **Update** button to download the new version; the installer will start.

6.4. Detailed Instructions

6.4.1. Establish the Connection

Make sure that the computer and the device are connected via USB. If you connect **Transmitter**, it must be in **Configuration** mode.

6.4.2. Start the LDU and Follow the Instructions

After launching LDU the welcome screen will appear. Pressing the  button a list will appear showing the supported devices. Click on the **Extender** button on the main screen.

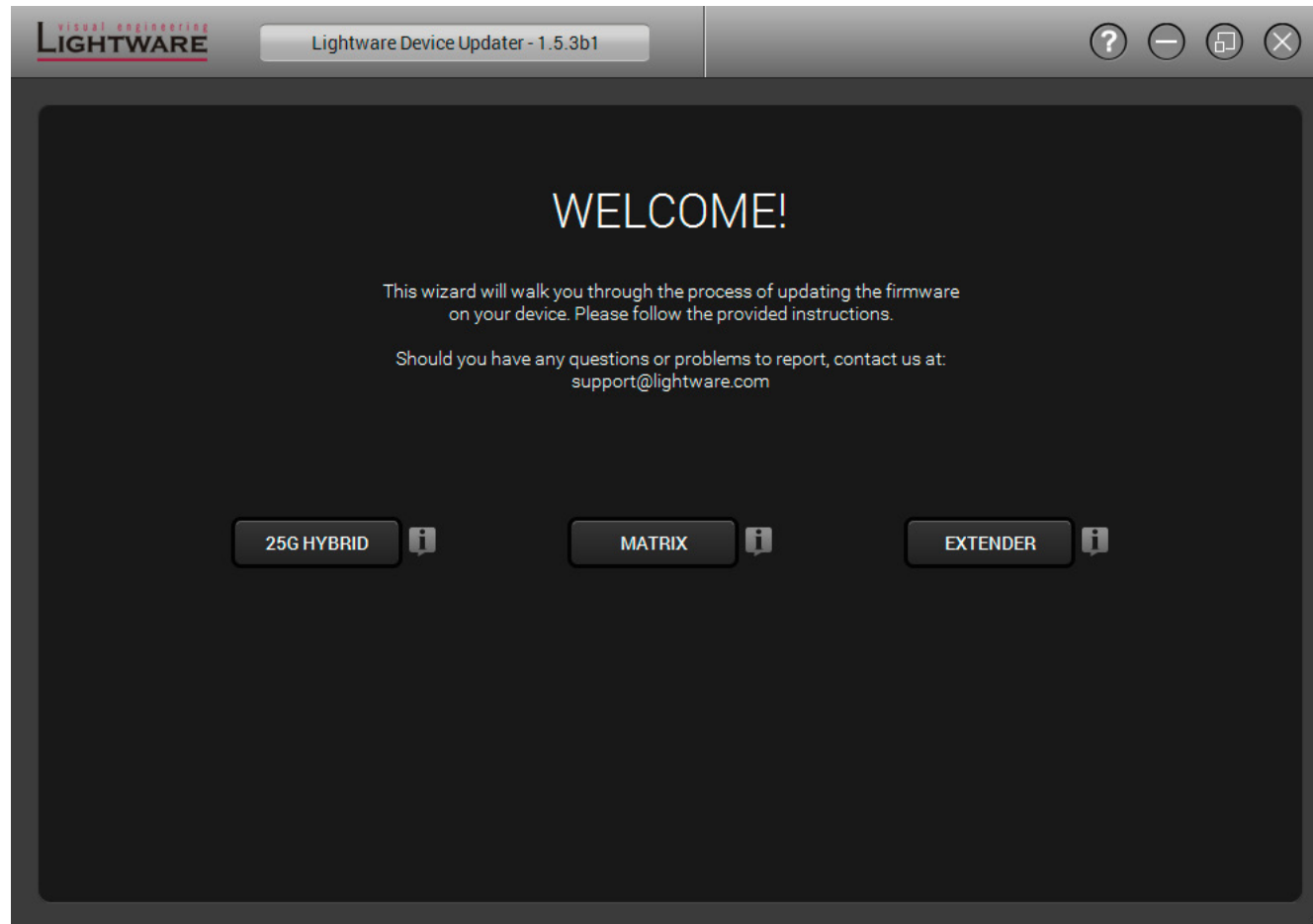

Step 1. Select the Package.

Click on the Browse button and select the “.lfp” file that will be used for the upgrade.

Package information is displayed:

- **General** version info, creation date, short description,
- **Devices** which are compatible with the firmware,
- **Components** in the package with release notes.

Click on the **Next** button and follow the instructions.

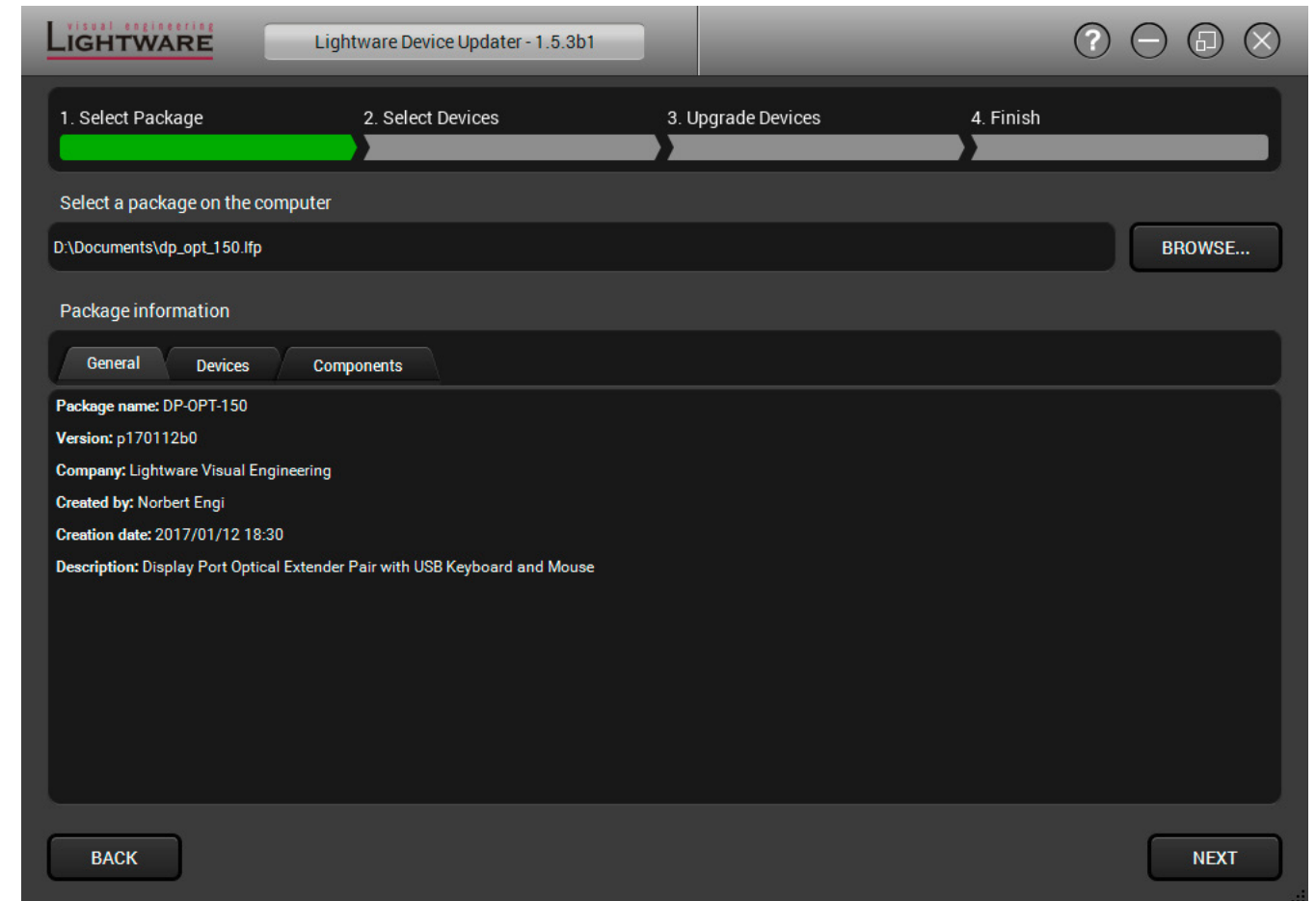

TIPS AND TRICKS: Files with “.lfp” extension are associated to LDU during installation. If you double click on the “.lfp” file, the application is launched, the package is loaded automatically and above screen is shown.

Step 2. Select the Device.

The following step is to select the desired device(s). The available and supported devices are searched and listed automatically. If the desired device is not listed, update the list by clicking the **Refresh** button. Select the desired devices: highlight them with a **yellow cursor**, then click **OK**.

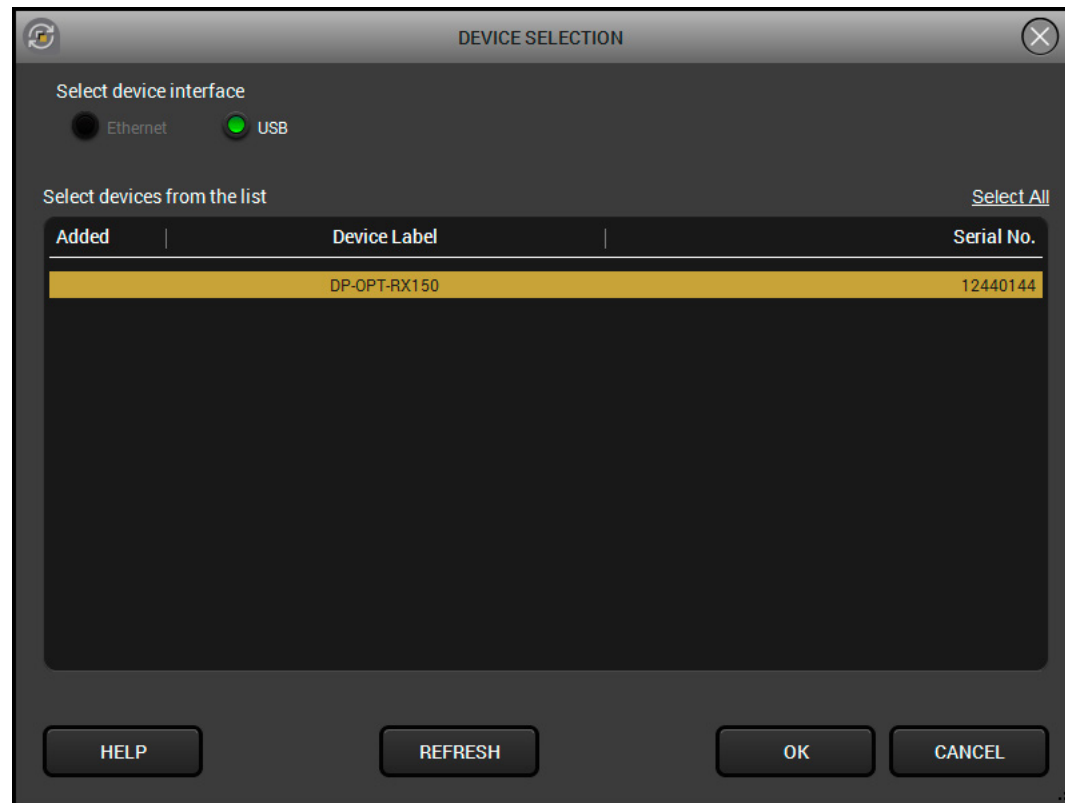

A tick mark can be seen in the **Added** column if the device was added by the user previously.

Firmware Components

The firmware components of the selected devices are listed on the following screen: installed and update versions. (Update version will be uploaded to the device.)

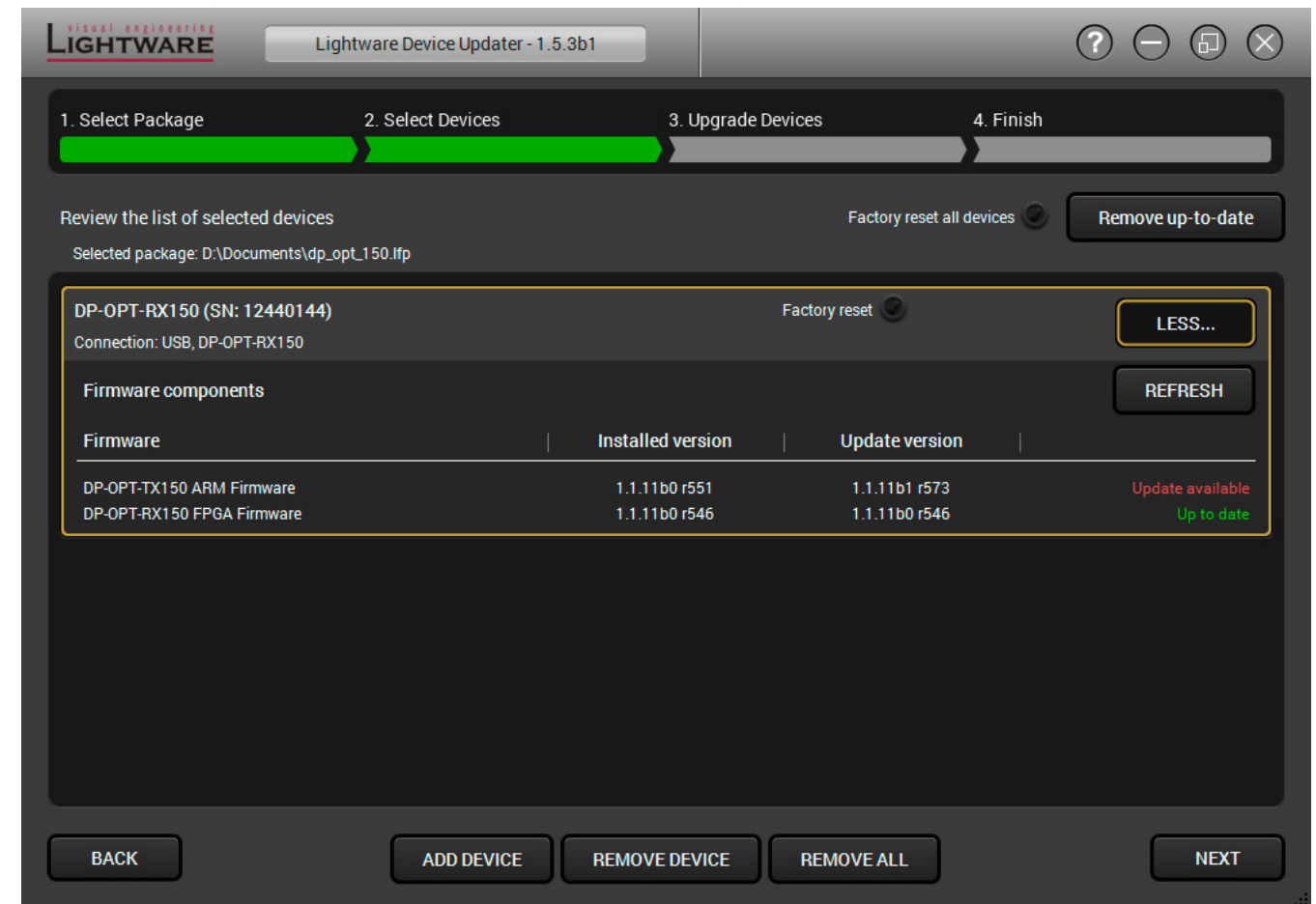

Add a device by clicking on the **Add device** button. The previous screen will be shown; select the desired device(s) and click on **OK**. Remove a device by selecting it (highlight with yellow) and click on **Remove device** button, or click on **Remove all** button to empty the list.

Enabling **Factory reset** will perform factory default values for all settings in the device. The following cases may appear:

- **Enabled by user:** all settings will set to factory default values.
- **Disabled by user:** your settings will be saved and restored after upgrading.
- **Enabled by default and not changeable by user:** firmware upgrade must perform a factory reset to apply all changes coming with the new firmware version.

Click on the **Next** button to continue.

Step 3. Upgrade the device.

Click on the **Start** button to continue.

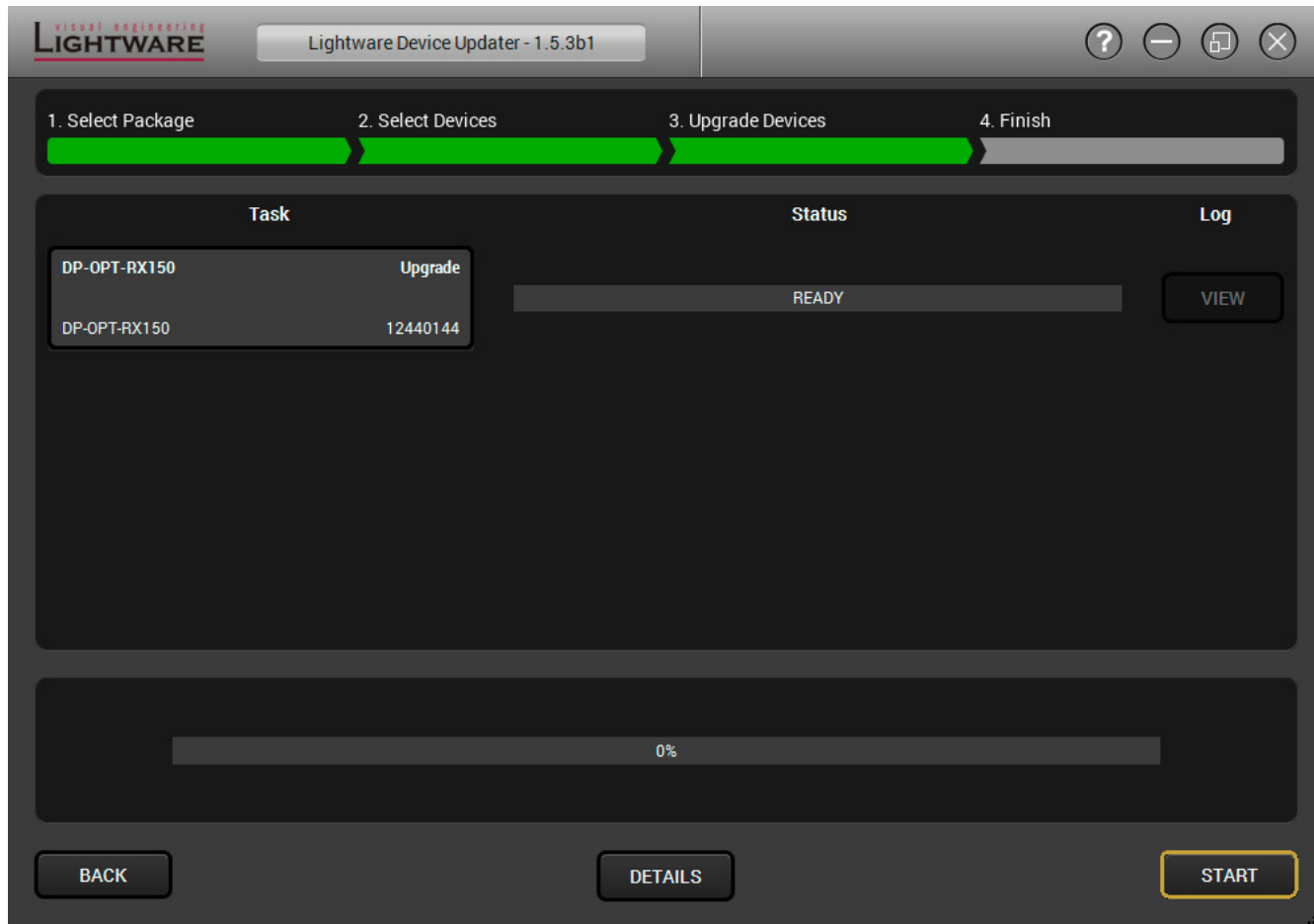

A window will pop up before starting upgrading the device; confirm by the **OK** button or **Cancel** to stop the process.

When you confirmed the upgrade process is started.

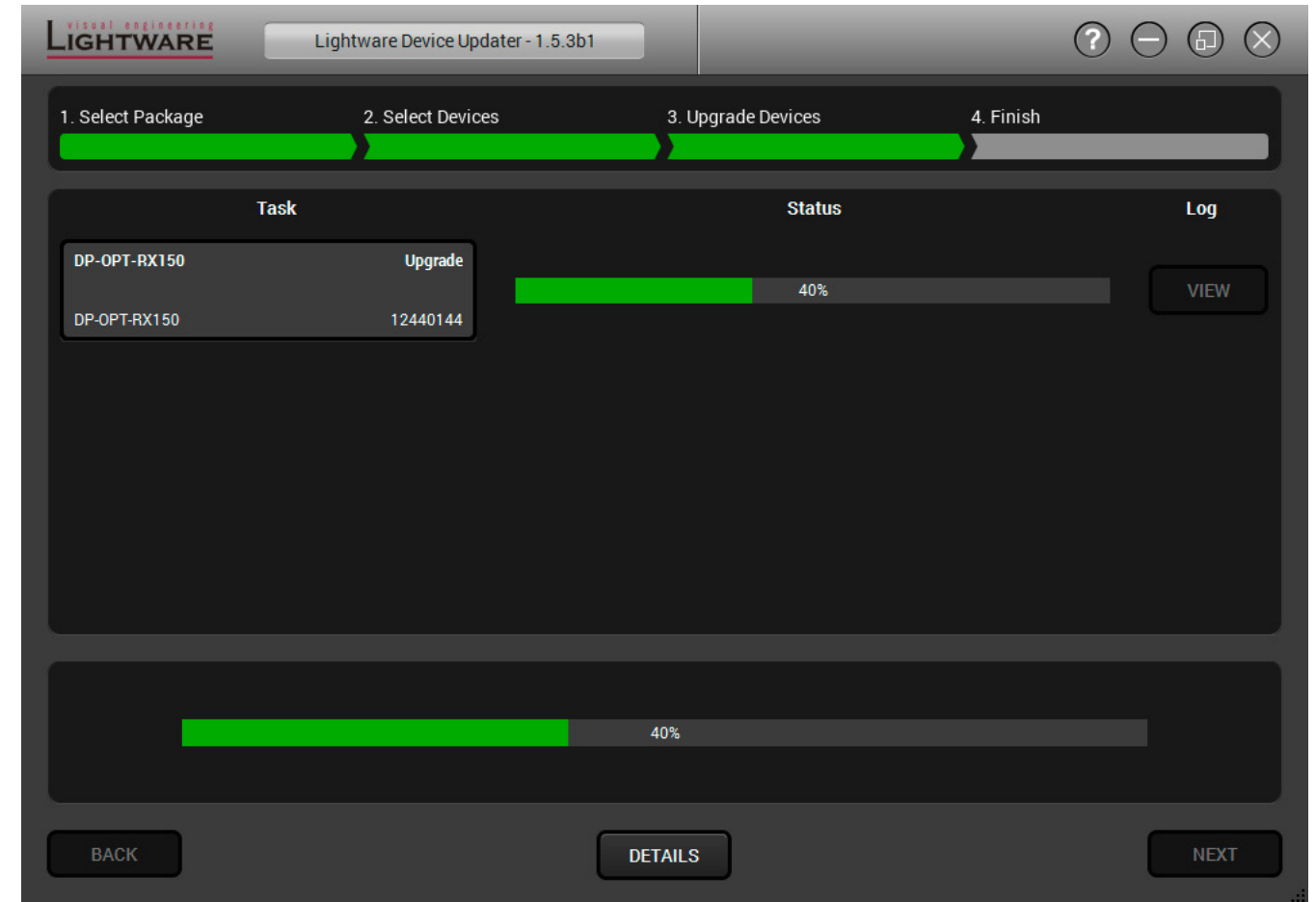

Details button opens a new window where the process is logged.

Step 4. Finish.

If the upgrade of a device is finished, the log can be opened by the View button on the right. When all the tasks are finished, a window appears. Click **OK** to close and **Next** to display the summary page.

Repeat button starts the process again with the selected device(s). **Open logs** button opens the temporary folder where the logs can be found. **Export logs** by saving the files as a zipped file.

Press **Exit** to close the program.

If the upgrade failed, the progress bar of the device is changed to red; restart the devices and repeat the process.

ATTENTION! However the device is rebooted after the firmware upgrade, switching it off and on again is recommended.

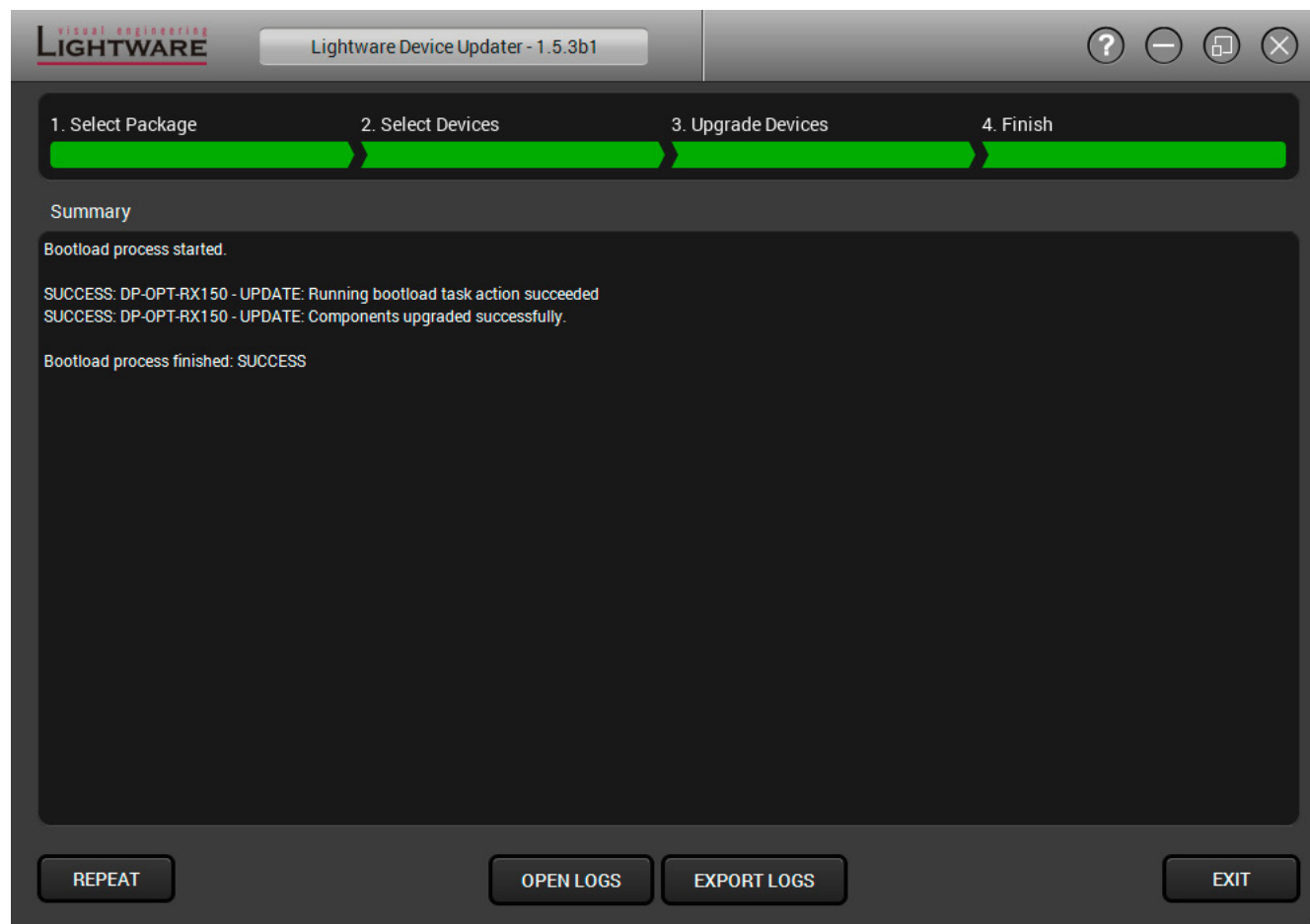
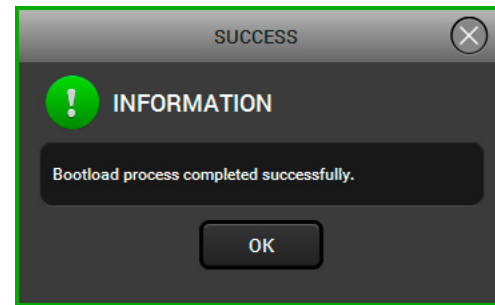

7

Troubleshooting

Usually, if the system seems not to transport the signal as expected, the best strategy for troubleshooting is to check signal integrity through the whole signal chain starting from source side and moving forward to receiver end.

Symptom	Root cause	Action
General video signal problems		
Picture is not displayed or distorted	Video connectors are loose	Make sure the connectors fit well.
	Another port is selected in the source/display device	Select the desired/connected port.
	When adaptor cable is applied: the source port does not support the Dual-mode	Extend the picture to a DisplayPort capable display device.
	The monitor is not able to display the desired image resolution	Select another display device or reduce the image resolution.
	Protected image is extended to a non-HDCP capable device	If the monitor does not support displaying HDCP-encrypted image content try to disable the HDCP (if the content allows).
	The fiber optical connector is not plugged or dirty	Check and clean the connectors carefully if necessary.
Audio problems		
No audio is present	Not the right interface is selected in the source device	If the source is a computer make sure the audio is embedded in the video stream and not switched to an analog output.
	The audio output is muted in the source	Check the source device settings.
USB problems		
Extended USB device does not work	The desired device is not connected	Check the cable connections; pay attention to the USB HUB if it was installed.
	The Transmitter is in Configuration mode	In this case only one USB HID device is transmitted. Switch the Transmitter to Transparent mode if possible.
	Not supported USB device is connected	Only USB HID devices can be extended from the Transmitter to the Receiver. Check if it is supported.
	The USB device is not supported by the source computer	Check the device by plugging in the computer directly.
Local USB device does not work	The USB device is not supported by the source computer	Check the device by plugging in the computer directly.

8

Technologies

The following sections contain descriptions and useful technical information how the devices work in the background. The content is based on experiences and cases we met in the practice. These sections help to understand features and technical standards like the followings:

- ▶ [HDCP MANAGEMENT](#)
- ▶ [DISPLAYPORT](#)

8.1. HDCP Management

Lightware Visual Engineering is a legal HDCP adopter. Several functions have been developed which helps to solve HDCP related problems. Complex AV systems often have both HDCP and non-HDCP components. The devices allow transmitting HDCP encrypted and unencrypted signals. The devices will be still HDCP compliant as they will never output an encrypted signal to a non-HDCP compliant display device. If an encrypted signal is switched to a non-compliant output, a red screen alert or muted screen will appear.

8.1.1. Protected and Unprotected Content

Many video sources send HDCP protected signal if they detect that the sink is HDCP capable – even if the content is not copyrighted. This can cause trouble if an HDCP capable device is connected between the source and the display. In this case, the content cannot be viewed on non-HDCP capable displays and interfaces like event controllers. Rental and staging technicians often complain about certain laptops, which are always sending HDCP encrypted signals if the receiver device (display, matrix router, etc.) reports HDCP compliancy. However, HDCP encryption is not required all the time e.g. computer desktop image, certain laptops still do that.

To avoid unnecessary HDCP encryption, Lightware introduced the HDCP enabling/disabling function: the HDCP capability can be disabled in the Lightware device. If HDCP is disabled, the connected source will detect that the sink is not HDCP capable, and turn off authentication.

8.1.2. Real-life Examples

Sink with DisplayPort

All the devices are HDCP-compliant, no manual setting is required, both protected and unprotected content is transmitted and displayed on the sink.

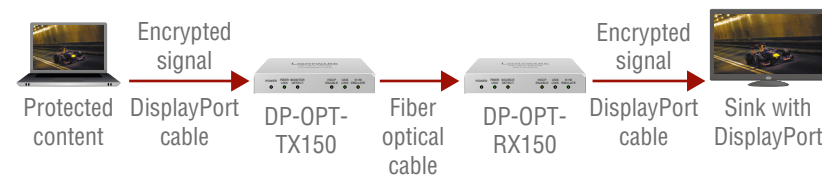

HDCP-compliant Sink (HDMI/DVI)

The display device is connected to the receiver through a passive DVI/HDMI adaptor. The sink is HDCP-compliant, so the situation is similar then in first case: no manual setting is required, both protected and unprotected content transmitted and displayed.

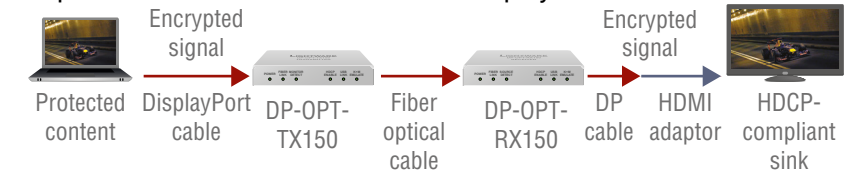

Non-HDCP Compliant Sink (HDMI/DVI) 1.

The non-HDCP compliant display device is connected to the receiver through a passive DVI/HDMI adaptor. Some sources (e.g. computers) always send HDCP encrypted signals if the receiver device reports HDCP compliancy, however HDCP encryption is not required all the time (e.g. computer desktop image). If the HDCP is enabled in the extenders, the image will not be displayed.

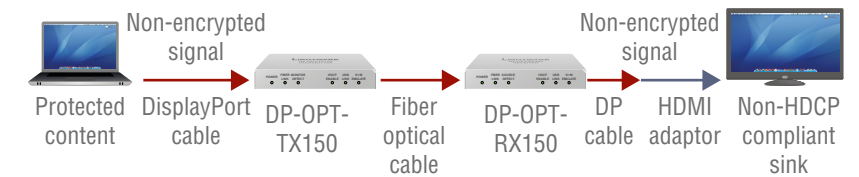

On DP-OPT extenders 'HDCP enable' function can be disabled (HDCP LED is dark), thus the source can be forced to send non-encrypted signal. Since the image content is unprotected, the source will send the signal and the sink will display the image.

Non-HDCP Compliant Sink (HDMI/DVI) 2.

The layout is the same as in previous case: non-HDCP compliant display device is connected to the receiver. Now the difference is that the content is protected, thus the source is sending encrypted signal. In this case the source does not send any signal because it detects non-compliant system.

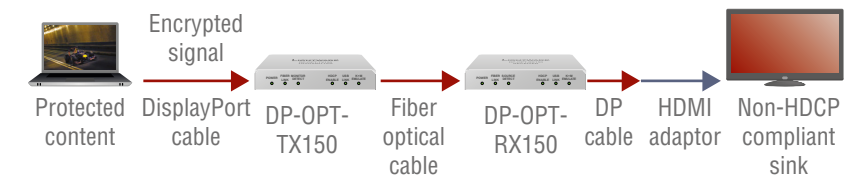

The display device will show muted screen or pop up an error message that the sink is not HDCP-compliant. The solution is to replace the display device to a HDCP-capable one.

8.2. DisplayPort

DisplayPort is a widely spread audio/video interface standard designed by VESA (Video Electronics Standard Association) in 2006. The aim was to create such an interface that would be the connection between graphic cards and display devices. The standard is available and free thus it can be implemented widely, which could help replacing the previously used interfaces, such as VGA or DVI.

Lightware's DP-OPT extenders are designed according to DisplayPort standard 1.1a. The maximum allowed bandwidth is 10.8 Gbps, which means e.g. 2560x1600 pixel resolution at 60 Hz or 4096x2400 pixels at 30 Hz. Color depth until 16 bits per color and 8-channel embedded LPCM audio is supported.

8.2.1. Dual Mode

Mentioned standard was designed to support HDMI/DVI display devices too. If the sink is assembled with DVI or HDMI input connector, it can be connected to a dual mode DisplayPort source by a passive adaptor (DP++). In this case, source switches to DVI/HDMI mode and the signal is changed to be in line with DVI/HDMI requirements.

INFO: Most of the sources assembled with DisplayPort supports Dual mode, but if you are not sure check the documentation of your device.

Passive adaptor

Display device with HDMI or DVI connector can be connected by a passive DP-HDMI or DP-DVI adaptor to the source. The passive adaptor has two functions: sending a sign to the source if DVI or HDMI signal is required, and doing level shifting from +3.3V to +5V. The source switches to DVI/HDMI mode and sends the proper signal.



DP-DVI and DP-HDMI Passive Adaptors

INFO: More information about adaptors can be found in VESA DisplayPort Interoperability Guideline (www.displayport.org).

9

Appendix

- ▶ SPECIFICATIONS
- ▶ MECHANICAL DRAWINGS
- ▶ FURTHER INFORMATION

9.1. Specifications

General

Compliance	CE
EMI/EMC	EN 55035:2017, EN 55032:2015
Safety	EN 60065:2014, Class II
Warranty	3 years
Operating temperature	0°C ~ +55°C
Humidity	10 ~ 90% RH
Power source	100-240 V AC; 50~60 Hz

Power

Power supply.....	External power adaptor
Power adaptor.....	Input 100-240V AC 50/60Hz, Output 5V DC, 2A
Power consumption (TX150)	2.75W (typ)
.....	3W (max., without USB extension)
.....	3.1W (typ, with USB extension)
.....	8.2W (max., with 2x500mA for local USB devices)
Power consumption (RX150)	3.25W (typ)
.....	3.5W (max., without USB extension)
.....	3.75W (typ., with USB extension)

Enclosure

Material.....	Solid aluminum body
Dimensions (mm)	W110 x D95 x H18
Dimensions (inch).....	W4.3 x D3.7 x H0.7
Net weight	300g / unit

Connectors / ESD protection (HBM EIA/JESD22-A114F)

Video in / out.....	Standard DisplayPort 20-pole connector / 8 kV
Optical fiber in/out	SC receptacle / 8 kV
USB port for devices	USB-A receptacle / 4 kV
USB port for control	USB Mini-B receptacle / 4 kV
Power connector.....	DC connector (1.35 mm pin) / 2 kV

Digital video signal

Standard	DisplayPort 1.1a (Dual-mode)
Color depth.....	24, 30, 36, 48 bits deep color
Date rates	1.62 / 2.7 Gbps (1.65 Gbps /lane), max. 10.8 Gbps total
Video delay	0 frame
Max resolution at 60 Hz	2560x1600 pixels
Max resolution at 30 Hz	4Kx2K, 4096x2400 pixels
Max resolution at 120 Hz	1920x1080 pixels, 24 bit
HDCP pass through	Supported

Optical

Fiber type.....	50/125 SC Multimode (preferred)
.....	62.5/125 SC Multimode
Laser wavelengths	High speed lanes: 778; 800; 825; 850 nm
.....	Low speed lanes: 911; 980 nm
Laser class specification.....	Class 3R
Transmitter output OMA*	-6.25 dBm (worst case)
Receiver OMA* sensitivity	-14.25 dBm (worst case)
Transmission distance	1100 meters (using OM4 50/125 fiber)
.....	800 meters (using OM3 50/125 fiber)
.....	350 meters (using OM2 50/125 fiber)
.....	150 meters (using OM1 62.5/125 fiber)

*OMA: Optical Modulation Amplitude

USB support

USB control (TX150: labelled 'CPU')	USB 2.0
USB control (RX150: labelled 'Service')	USB 2.0
Local USB ports (TX150).....	USB 2.0 HiSpeed 480 Mbps
Extended USB ports (RX150)	USB HID

9.2. Mechanical Drawings

The dimensions are in mm.

Front View

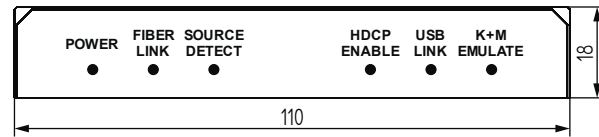

Rear View

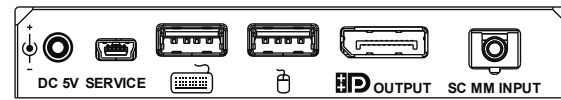

Top View



Bottom View

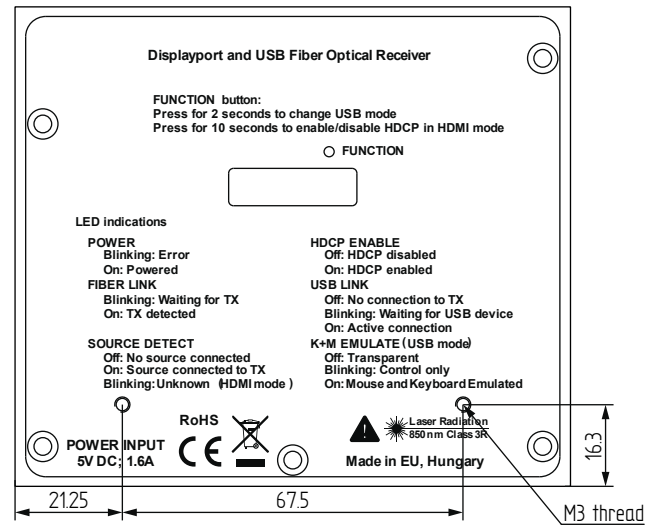

Left Side View

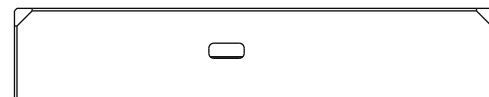

9.3. Further Information

Limited Warranty Statement

1. Lightware Visual Engineering LLC (Lightware) warrants to all trade and end user customers that any Lightware product purchased will be free from manufacturing defects in both material and workmanship for three (3) years from purchase unless stated otherwise below. The warranty period will begin on the latest possible date where proof of purchase/delivery can be provided by the customer. In the event that no proof can be provided (empty 'Date of purchase' field or a copy of invoice), the warranty period will begin from the point of delivery from Lightware.

1.1. 25G and MODEX product series will be subject to a seven (7) year warranty period under the same terms as outlined in this document.

1.2. If during the first three (3) months of purchase, the customer is unhappy with any aspect of a Lightware product, Lightware will accept a return for full credit.

1.3. Any product that fails in the first six (6) months of the warranty period will automatically be eligible for replacement and advanced replacement where available. Any replacements provided will be warranted for the remainder of the original unit's warranty period.

1.4. Product failures from six (6) months to the end of the warranty period will either be repaired or replaced at the discretion of Lightware. If Lightware chooses to replace the product then the replacement will be warranted for the remainder of the original unit's warranty period.

2. The above-stated warranty and procedures will not apply to any product that has been:

2.1. Modified, repaired or altered by anyone other than a certified Lightware engineer unless expressly agreed beforehand.

2.2. Used in any application other than that for which it was intended.

2.3. Subjected to any mechanical or electrical abuse or accidental damage.

2.4. Any costs incurred for repair/replacement of goods that fall into the above categories (2.1., 2.2., 2.3.) will be borne by the customer at a pre-agreed figure.

3. All products to be returned to Lightware require a return material authorization number (RMA) prior to shipment and this number must be clearly marked on the box. If an RMA number is not obtained or is not clearly marked on the box, Lightware will refuse the shipment.

3.1. The customer will be responsible for in-bound and Lightware will be responsible for out-bound shipping costs.

3.2. Newly repaired or replaced products will be warranted to the end of the originally purchased products warranty period.

Document Revision History

Rev.	Release date	Changes	Editor
1.0	01-10-2013	Initial version	Laszlo Zsedenyi
1.1	25-11-2014	Firmware upgrade process, Lightware Device Updater and Lightware Device Controller added	Laszlo Zsedenyi
1.2	19-02-2015	DisplayPort connector pin assignments corrected	Laszlo Zsedenyi
1.3	15-12-2015	Safety instructions updated, CE page pulled out	Laszlo Zsedenyi
1.4	06-10-2016	Minor updates to the latest LDC and LDU software, updated warranty info	Tamas Forgacs
2.0	13-03-2018	New document format introduced; latest SW and FW editions added.	Laszlo Zsedenyi
2.1	30-10-2018	1080p120 Hz signal support info added.	Laszlo Zsedenyi

Contact Us

sales@lightware.com

+36 1 255 3800

support@lightware.com

+36 1 255 3810

Lightware Visual Engineering LLC.
Peterdy 15, Budapest H-1071, Hungary

www.lightware.com