

visual engineering
LIGHTWARE

User's Manual



MX8x8HDMI-Pro
MX8x8DVI-HDCP-Pro

Multimedia Signal Distribution Amplifier

Important Safety Instructions

Class I apparatus construction.

This equipment must be used with a mains power system with a protective earth connection. The third (earth) pin is a safety feature, do not bypass or disable it. The equipment should be operated only from the power source indicated on the product.

To disconnect the equipment safely from power, remove the power cord from the rear of the equipment, or from the power source. The MAINS plug is used as the disconnect device, the disconnect device shall remain readily operable.

There are no user-serviceable parts inside of the unit. Removal of the cover will expose dangerous voltages. To avoid personal injury, do not remove the cover. Do not operate the unit without the cover installed.

The appliance must be safely connected to multimedia systems. Follow instructions described in this manual.

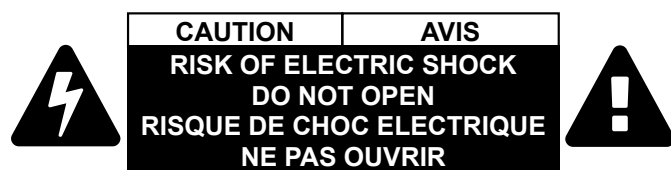

Replacing the AC fuse

Unplug the AC power cord from the device. Locate the AC fuse on the rear panel. Replace only the AC fuse as indicated on the rear panel. Connect the power cord to the switcher and to the AC power source. Make sure the switcher is working properly.

Ventilation

For the correct ventilation and to avoid overheating ensure enough free space around the appliance. Do not cover the appliance, let the ventilation holes free and never block or bypass the ventilators (if any).

WARNING

To prevent injury, the apparatus is recommended to securely attach to the floor/wall or mount in accordance with the installation instructions. The apparatus shall not be exposed to dripping or splashing and that no objects filled with liquids, such as vases, shall be placed on the apparatus. No naked flame sources, such as lighted candles, should be placed on the apparatus.

Waste Electrical & Electronic Equipment WEEE

This marking shown on the product or its literature, indicates that it should not be disposed with other household wastes at the end of its working life. To prevent possible harm to the environment or human health from uncontrolled waste disposal, please separate this from other types of wastes and recycle it responsibly to promote the sustainable reuse of material resources. Household users should contact either the retailer where they purchased this product, or their local government office, for details of where and how they can take this item for environmentally safe recycling. Business users should contact their supplier and check the terms and conditions of the purchase contract. This product should not be mixed with other commercial wastes for disposal.

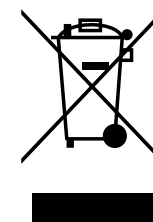

Common Safety Symbols

Symbol	Description
	Alternating current
	Protective conductor terminal
	Caution, possibility of electric shock
	Caution

Symbol Legend

The following symbols and markings are used in the document:

WARNING! Safety-related information which is highly recommended to read and keep in every case!

ATTENTION! Useful information to perform a successful procedure; it is recommended to read.

INFO: A notice which may contain additional information. Procedure can be successful without reading it.

DEFINITION: The short description of a feature or a function.

TIPS AND TRICKS: Ideas which you may have not known yet but can be useful.

Navigation Buttons

 Go back to the previous page. If you clicked on a link previously, you can go back to the source page by clicking the button.

 Navigate to the Table of Contents.

 Step back one page.

 Step forward to the next page.

Document Information

All presented functions refer to the indicated products. The descriptions have been made during testing these functions in accordance with the indicated Hardware/Firmware/Software environment:

Item	Version
Lightware Device Controller (LDC) software	1.23.1
Lightware Bootloader Software	3.3.3
MX-DVI-CPU firmware	2.5.0
Control Panel (CP1) firmware	1.0.8
MX-DVI-EDID card firmware	2.3.5
Built-in Web Server	1.1.6
Built-in Web Content	1.4.1
Motherboard hardware revision	1.1
Slot 1 hardware revision	1.1
Slot 2 hardware revision	1.2
Control Panel (CP1) hardware revision	2.1

Document revision: **3.0**

Release date: 30-08-2018

Editor: Laszlo Zsedenyi

About Printing

Lightware Visual Engineering supports green technologies and Eco-friendly mentality. Thus, this document is made for digital usage primarily. If you need to print out few pages for any reason, follow the recommended printing settings:

- Page size: A4
- Output size: Fit to page or Match page size
- Orientation: Landscape

TIPS AND TRICKS: Thanks to the size of the original page, a border around the content (gray on the second picture below) makes possible to organize the pages better. After punching the printed pages, they can be placed easily into a ring folder.

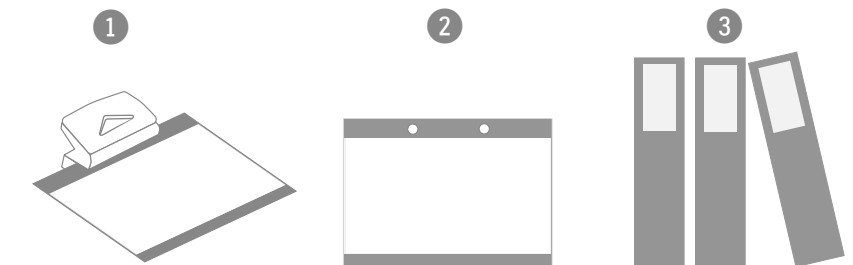

Table of Contents

1. INTRODUCTION	6	6. SOFTWARE CONTROL - LIGHTWARE DEVICE CONTROLLER	19	7.3. PORT SETTINGS	35
1.1. DESCRIPTION	6	6.1. INSTALL AND UPGRADE	19	7.3.1. Switch One Input to One Output	35
1.2. BOX CONTENTS	6	6.2. RUNNING THE LDC.....	19	7.3.2. Switch One Input to All Outputs	35
1.3. FEATURES OF THE DEVICE.....	7	6.3. CONNECTING TO A DEVICE (DEVICE DISCOVERY WINDOW).....	20	7.3.3. Mute Specified Output	35
2. INSTALLATION	8	6.4. THE CROSSPOINT MENU.....	21	7.3.4. Unmute Specified Output.....	35
2.1. MOUNTING.....	8	6.4.1. Grid View.....	21	7.3.5. Lock the Output	35
2.2. CONNECTING STEPS.....	8	6.5. TILE VIEW	23	7.3.6. Unlock the Output.....	36
3. PRODUCT OVERVIEW	9	6.5.1. Port Tiles.....	24	7.3.7. View Connection State.....	36
3.1. FRONT VIEW.....	9	6.5.2. Display Modes	24	7.3.8. View Mutes on All Outputs	36
3.2. REAR VIEW.....	10	6.5.3. Crosspoint Operations	24	7.3.9. Save Preset	36
3.2.1. MX8x8HDMI-Pro.....	10	6.5.4. Port Properties and Settings	25	7.3.10. Load Preset.....	36
3.2.2. MX8x8DVI-HDCP-Pro	10	6.5.5. Frame Detector.....	25	7.3.11. View Preset Without Loading	36
3.3. ELECTRICAL CONNECTIONS.....	11	6.5.6. Presets	26	7.3.12. Name Presets.....	36
3.3.1. HDMI Connector.....	11	6.6. EDID MENU	27	7.3.13. Name Inputs	37
3.3.2. DVI-I Connector.....	11	6.6.1. EDID Operations	28	7.3.14. Name Outputs	37
3.3.3. Ethernet Connector (LAN port).....	11	6.6.2. EDID Summary Window	28	7.3.15. Query Preset Name	37
3.3.4. S/PDIF Connector.....	11	6.6.3. Editing an EDID	29	7.3.16. Query Input Name	37
3.3.5. RS-232 Connector	11	6.6.4. Creating an EDID.....	29	7.3.17. Query Output Name.....	37
4. OPERATION	12	6.7. SETTINGS MENU	30	7.3.18. Reload Default Preset Names	37
4.1. POWERING ON.....	12	6.7.1. Configuration Tab.....	30	7.3.19. Reload Default Input Names.....	37
4.2. FRONT PANEL OPERATIONS	12	6.7.2. Device Information Tab.....	31	7.3.20. Reload Default Output Names.....	37
4.2.1. Take / Autotake Mode.....	12	6.7.3. Status Tab.....	31	7.4. NETWORK CONFIGURATION	38
4.2.2. View Crosspoint State.....	13	6.7.4. Log Tab	31	7.4.1. Query the Current IP Configuration	38
4.2.3. View Live Inputs and Attached Sinks	13	6.7.5. User Preferences	32	7.4.2. Reload Factory Default IP Settings.....	38
4.2.4. Preset Operations.....	13	6.8. TERMINAL WINDOW	32	7.4.3. Enable DHCP IP Setting	38
4.2.5. Output Lock	14	7. PROGRAMMERS' REFERENCE	33	7.5. EDID ROUTER COMMANDS	38
4.2.6. Control Lock.....	15	7.1. PROTOCOL DESCRIPTION	33	7.5.1. Change EDID on Input	38
4.2.7. IP Settings.....	15	7.2. GENERAL COMMANDS	33	7.5.2. Change EDID on All Inputs	38
4.2.8. Control Protocols	15	7.2.1. View Product Type.....	33	7.5.3. Save EDID to User Memory.....	38
4.3. FRONT PANEL LCD MENU OPERATION	16	7.2.2. View Firmware Version of the CPU	33	7.5.4. View Emulated EDIDs on All Inputs.....	39
4.3.1. Menu concept.....	16	7.2.3. View Serial Number.....	34	7.5.5. Watch EDID Validity Table.....	39
4.3.2. Normal Mode.....	16	7.2.4. Compile Time.....	34	7.5.6. View EDID Header	39
4.3.3. EDID Mode.....	17	7.2.5. View Installed Boards.....	34	7.5.7. Delete EDID from Memory	39
4.3.4. Signal Present Mode.....	17	7.2.6. View Firmware for All Controllers.....	34	7.5.8. Download EDID Content.....	39
4.4. SOFTWARE CONTROL MODES.....	17	7.2.7. Restart the Device	34	7.5.9. Upload EDID Content to the Router	40
5. SOFTWARE CONTROL – USING THE BUILT-IN WEB	18	7.2.8. Query Health Status	34	7.6. PORT STATUS COMMANDS	40
5.1. ESTABLISHING THE CONNECTION	18	7.2.9. View Current Communication Protocol	34	7.6.1. Input Port Status	40
5.2. THE LAYOUT OF THE BUILT-IN WEB	18	7.2.10. Set Communication Protocol	34	7.6.2. Output Port Status.....	40
		7.2.11. Count HDCP Keys.....	35	7.6.3. Get Information about Input Port	41
		7.2.12. Clear HDCP Key Cache	35	7.6.4. Get Information about the Output Port.....	44
				7.6.5. Set HDMI Output Port Parameters.....	45
				7.6.6. Color Range Conversion Settings.....	45
				7.6.7. Measure Timing Parameters	46

7.7. PROGRAMMERS' REFERENCE – QUICK SUMMARY	47
8. FIRMWARE UPGRADE	49
8.1. SHORT INSTRUCTIONS	49
8.2. DETAILED INSTRUCTIONS.....	49
9. TROUBLESHOOTING	52
10. TECHNOLOGIES.....	53
10.1. EDID MANAGEMENT	53
10.1.1. Understanding the EDID.....	53
10.1.2. Advanced EDID Management.....	53
10.2. HDCP MANAGEMENT	54
10.2.1. Protected and Unprotected Content	54
10.2.2. Disable Unnecessary Encryption.....	54
10.3. PIXEL ACCURATE RECLOCKING	54
11. APPENDIX	55
11.1. SPECIFICATIONS	55
11.2. FACTORY DEFAULT SETTINGS.....	56
11.3. FACTORY EDID LIST.....	56
11.4. MECHANICAL DRAWINGS	57
11.5. FURTHER INFORMATION.....	58

1

Introduction

Thank You for choosing Lightware's MX8x8HDMI-Pro series standalone matrix switchers. In the first chapter we would like to introduce the device highlighting the most important features in the below listed sections:

- ▶ [DESCRIPTION](#)
- ▶ [BOX CONTENTS](#)
- ▶ [FEATURES OF THE DEVICE](#)

1.1. Description

MX8x8HDMI-Pro digital video router is the most advanced HDMI router that supports DVI 1.0 HDCP 1.3 and even HDMI 1.3 deep color standards. This highest performance routing switcher offers 8 inputs and 8 outputs with HDMI connectors. The built-in sophisticated software and hardware features make the router the most flexible and integrated solution for AV professionals and high end home theatre applications. Any input can be switched to any or more outputs without switching delay or frame latency.

Supporting HDMI 1.3 36 bit deep color standard, it can be connected even to the latest Blu-ray players, set top boxes, AV receivers. Advanced HD audio transmission and sample rate conversion proves the compatibility with previous generation products whilst handling the finest Dolby TrueHD and DTS-HD formats as well. DVI, HDMI and HDCP signals can be seamlessly integrated in any AV system using Lightware MX8x8HDMI-Pro.

All inputs are equalized and reclocked for up to 60 meter long DVI copper cable, and all outputs of the matrix router are reclocked for stable, jitter free signal transmission. The unit can be controlled either by RS-232 port or TCP/IP LAN connection or by built-in website.

Model Denomination

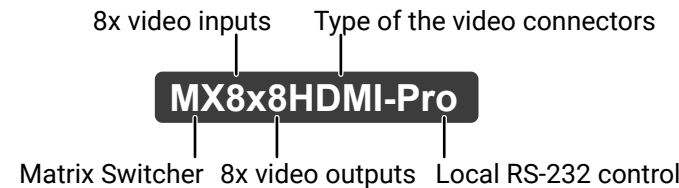

About the Serial Number

Lightware devices contain a label indicating the unique serial number of the product. The structure is the following:

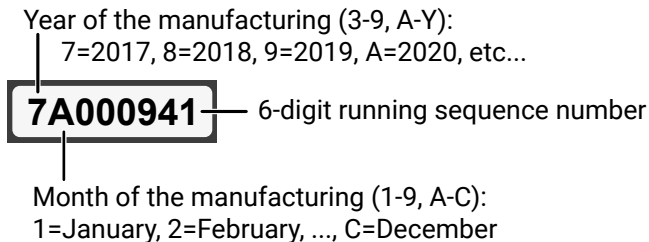

1.2. Box Contents

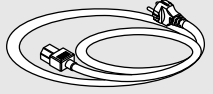
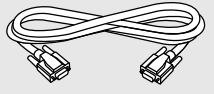
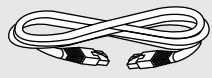
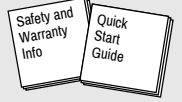
 <p>Matrix switcher</p>	 <p>IEC power cable</p>	 <p>9-pole D-sub male to female cable</p>
 <p>UTP cross-link cable</p>	 <p>Safety & warranty info, Quick Start Guide</p>	

1.3. Features of the Device



Advanced EDID Management

The user can emulate any EDID on the inputs independently, read out and store any attached monitor's EDID in 100 internal memory locations, upload and download EDID files using Lightware Device Controller software.

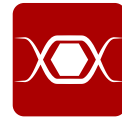

Pixel Accurate Reclocking

Each output has a clean, jitter free signal, eliminating signal instability and distortion caused by long cables or connector reflections.



Frame Detector and Signal Analysis

The exact video and audio signal format can be determined such as timing, frequencies, scan mode, HDCP encryption, color range, color space and audio sample rate.



Zero frame delay

No latency during input/output port switching.



HDCP-compliant

The matrix fulfills the HDCP standard. HDCP capability on the digital video inputs can be disabled when non-protected content is extended.



Non-blocking cross point matrix architecture

The router allows any input to be switched to any output or more outputs simultaneously.



Dolby TrueHD and DTS-HD audio

The matrix has Dolby TrueHD and DTS-HD audio support.



Supports all HDTV resolutions

720p, 1080i, 1080p 2K etc. HDTV signals up to 225 MHz pixel clock frequency regardless of the actual resolution passed through the router.

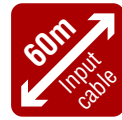

60 meter input cable compensation

Using 22AWG high quality DVI or HDMI cable, the inputs are automatically compensated for up to 60-meter cable length at 24bpp, which extends installation possibilities even at the highest HDTV or computer resolutions.



LCD menu control

Control the device locally with using the navigation buttons and the 2 line high LCD menu.



RS-232 / RS-422 controlling

Unit can be controlled over serial data communication with standard RS-232 or RS-422.



Ethernet control

Multiple simultaneous TCP/IP connections are available with a simple ASCII-based protocol for controlling, configuring the matrix or perform a firmware upgrade.



Color space and color range conversion

Video signals can be converted between RGB, YUV 4:4:4 and YUV 4:2:2 signals in all directions. Converting between limited and full range is also possible.



Deep Color support and conversion

It is possible to transmit the highest quality 30-bit or 36-bit video streams for perfect color reproduction. The signal can be converted freely on each output so you can get the best possible quality on every display.



DVI/HDMI conversion

The router is able to convert between DVI and HDMI signals so that you can watch HDMI videos on your computer display without audio.

2

Installation

The chapter is about the installation of the device and connecting to other appliances, presenting also the mounting options and further assembly steps.

- ▶ MOUNTING
- ▶ CONNECTING STEPS

2.1. Mounting

The housing of MX8x8HDMI-Pro series matrix contains built-in rack ears with mounting holes for the easy setup in rack-mount enclosures and any rack environment.



The matrix is 1U high rack sized.

ATTENTION! To ensure the correct ventilation and avoid overheating let enough free space around the appliance. Do not cover the appliance, let the ventilation holes free on both sides.

2.2. Connecting Steps

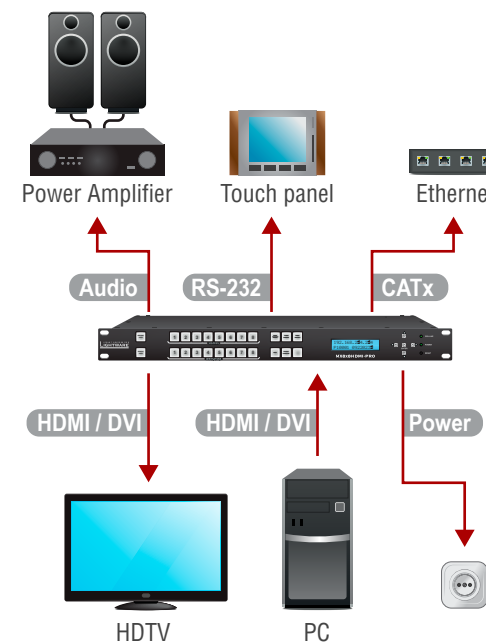

HDMI / DVI Connect the HDMI/DVI cable(s) between the source(s) to the input port(s) of the matrix.

HDMI / DVI Connect the HDMI/DVI cable(s) between the sink(s) and the output port(s) of the matrix.

Audio Optionally for S/PDIF audio extension: connect the audio cable(s) between the audio device (e.g. power amplifier) and the S/PDIF output port(s) or the matrix. *

RS-232 Optionally for serial extension: connect a controller device (e.g. touch panel) to the RS-232 port.

CATx Optionally connect the matrix to a LAN in order to control the device.

Power Firstly connect the power cable to the AC input connector on the matrix, then to the AC power socket.

* Only MX8x8HDMI-PRO model contains S/PDIF audio output ports.

3

Product Overview

The following sections are about the physical structure of the device, input/output ports and connectors

- ▶ [FRONT VIEW](#)
- ▶ [REAR VIEW](#)
- ▶ [ELECTRICAL CONNECTIONS](#)

3.1. Front View

MX8x8HDMI-Pro and MX8x8DVI-HDCP-Pro

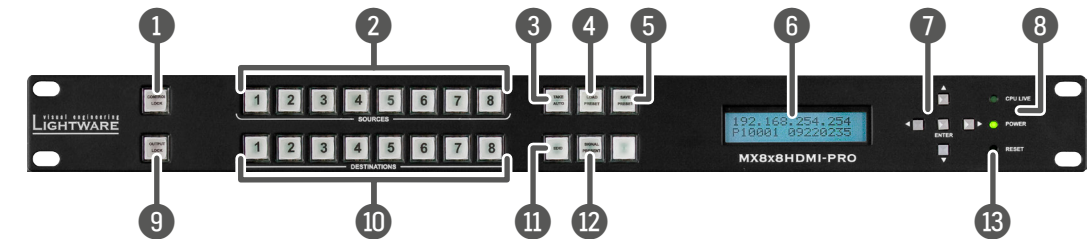

- | | | |
|----|-------------------------------|---|
| 1 | Control Lock button | Locking the front panel operation. Button lights red when the function is enabled. For more details about this function see the Control Lock section. |
| 2 | Sources buttons | Input selector buttons have two functions: to select an output, or to view the selected output's state. |
| 3 | Take / Autotake button | Button has two functions: displays the actual switching mode of the router (TAKE mode or AUTOTAKE mode) or executes switching in TAKE mode. For more details about these modes see the Take / Autotake Mode section. |
| 4 | Load Preset button | Loads and executes a previously saved preset; see the Preset Operations section. |
| 5 | Save Preset button | Stores the crosspoint state of the matrix; see the Preset Operations section. |
| 6 | LCD display | 2x16-character LCD display for menu operations; see the Front Panel LCD Menu Operation section. |
| 7 | Navigation buttons | UP, DOWN, LEFT, RIGHT, ENTER buttons for menu navigation. |
| 8 | Status LEDs | LEDs give feedback about the actual status of the matrix.
CPU LIVE dark: the device is not operational.
blinks: the device is in normal operation.
POWER dark: device is not powered.
lights: device is powered on. |
| 9 | Output Lock button | Locks and protects one (or more) outputs. It inhibits accidental input changing on protected outputs. |
| 10 | Destinations buttons | Output selector buttons have two functions: to select an output, or to view the selected output's state. |
| 11 | EDID button | Switches the LCD to EDID menu allowing EDID switch, EDID save, etc. For more details about this function see EDID Mode section. |
| 12 | Signal Present button | Displays live sources and attached sinks on source and destination buttons. |
| 13 | Reset button | Hardware reset button. It resets the whole router, however saved settings, presets and EDIDs will be preserved. |

3.2. Rear View

3.2.1. MX8x8HDMI-Pro

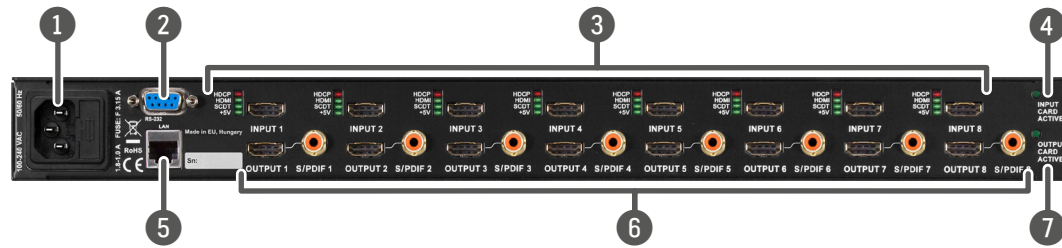

- 1 AC power connector** Standard IEC power connector. The router works with 100 to 240 Volts, 50 or 60 Hz power sources.
- 2 RS-232 connector** D-sub connector for the serial communication controlling the device.
- 3 Input ports and status LEDs** 8x HDMI 1.3 connectors for the sources and status LEDs for each inputs.
- 4 Input Card Active LED** LED gives feedback about actual status of the input card.
- 5 LAN port** Standard RJ45 connector for Ethernet connection controlling the device and performing firmware upgrade.
- 6 Output ports** 8x HDMI 1.3 connectors and 8x S/PDIF audio output ports for each HDMI outputs.
- 7 Output Card Active LED** LED gives feedback about actual status of the output card.

Input port status LEDs

HDCP LED

- off:** input signal is not HDCP-encrypted.
- on:** input signal is HDCP-encrypted.

+5V LED

- off:** source is not connected or not powered.
- on:** Source is connected and powered.

HDMI LED

- off:** input signal is DVI.
- on:** input signal is HDMI.

Input and output card activity LEDs

- off:** card is not active.
- on:** card is active and operational.

SCDT LED (Signal Detected)

- off:** video signal is not detected.
- on:** valid video signal is detected and sync can be extracted.

3.2.2. MX8x8DVI-HDCP-Pro

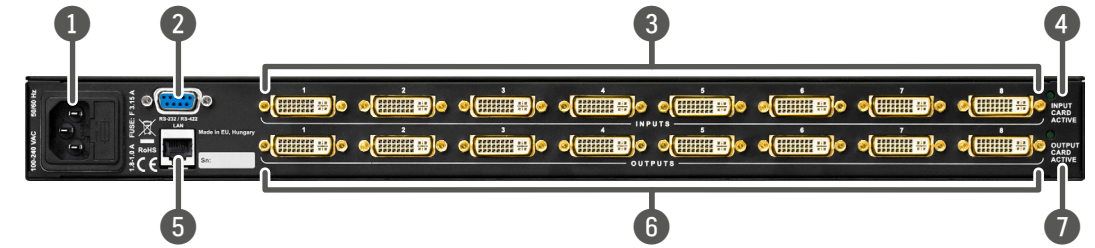

- 1 AC power connector** Standard IEC power connector. The router works with 100 to 240 Volts, 50 or 60 Hz power sources.
- 2 RS-232 connector** D-sub connector for the serial communication controlling the device.
- 3 Input ports** 8x DVI-I 1.0 connectors for the connection of the sources.
- 4 Input Card Active LED** LED gives feedback about actual status of the input card.
- 5 LAN port** Standard RJ45 connector for Ethernet connection controlling the device and performing firmware upgrade.
- 6 Output ports** 8x DVI-I 1.0 connectors for the connection of the destinations.
- 7 Output Card Active LED** LED gives feedback about actual status of the output card.

Input and output card activity LEDs

- off:** card is not active.
- on:** card is active and operational.

3.3. Electrical Connections

3.3.1. HDMI Connector

MX8x8HDMI-PRO matrix provides 8x input and 8x output standard 19-pole HDMI connectors. Always use high quality HDMI cable for connecting sources and displays.



3.3.2. DVI-I Connector

MX8x8DVI-HDCP-PRO contains 8x input and 8x output 29-pole DVI-I connectors. Users can plug in any DVI connector, but keep in mind that analog signals (such as VGA or RGBHV) are processed only on certain sinks. Always use high quality DVI cable for connecting sources and displays.



Fiber Cable Powering

As a special feature, Pro series matrix switchers provide 500 mA current on +5V output (pin 14 on DVI output connectors and pin 18 on HDMI output connectors) which is sufficient to supply power to fiber optical DVI cables. Standard DVI outputs or VGA cards only supply 55 mA current on +5V output, thus they are unable to directly power a fiber optical cable.

3.3.3. Ethernet Connector (LAN port)

The matrix switcher provides standard RJ45 connectors for LAN port. Always use high quality Ethernet cable.

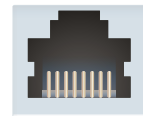

Wiring LAN cables

Lightware recommends the termination of LAN cables on the basis of TIA/EIA T 568 A or TIA/EIA T 568 B standards.



Pin	TIA/EIA T568 A	Color and name	TIA/EIA T568 B	Color and name
1		white/green stripe		white/orange stripe
2		green solid		orange solid
3		white/orange stripe		white/green stripe
4		blue solid		blue solid
5		white/blue stripe		white/blue stripe
6		orange solid		green solid
7		white/brown stripe		white/brown stripe
8		brown solid		brown solid

3.3.4. S/PDIF Connector

MX8x8HDMI-PRO matrix provides standard RCA receptacles for digital coaxial audio outputs.



ATTENTION! Plugs and sockets on consumer equipment are conventionally color-coded by CEA/CEDIA-863-B (ANSI) to aid correct connections. According to the standard Lightware uses orange colored RCA connectors for S/PDIF signals.

3.3.5. RS-232 Connector

The matrix contains an RS-232 port which can be connected by an industry standard 9-pole D-sub female connector.



4

Operation

This chapter is about the powering and operating of the device describing the functions which are available by the front/rear controls:

- ▶ POWERING ON
- ▶ FRONT PANEL OPERATIONS
- ▶ FRONT PANEL LCD MENU OPERATION
- ▶ SOFTWARE CONTROL MODES

4.1. Powering On

Connect the power cord to the device's IEC C14 standard power input connector. The router is immediately powered ON when the power cord is connected to the AC source (on Slim-matrices the power switch has to be in position 'ON'). If the self-test is finished the last configuration is reloaded and the appliance is ready to use.

INFO: After switching ON, the router reloads the latest settings that were used before it was turned off. The router has an internal emergency memory that stores all current settings and tie configurations. This memory is independent from presets and invisible for the user. This built-in feature helps the system to be ready immediately in case of power failure or accidental power down.

4.2. Front Panel Operations

4.2.1. Take / Autotake Mode

The router has two different switching modes: TAKE and AUTOTAKE. If the TAKE button is unlit, TAKE mode is active. When the TAKE button continuously illuminates green, AUTOTAKE mode is selected. Press and hold the TAKE button for two seconds to change between TAKE and AUTOTAKE modes.

4.2.1.1. Front panel controls in TAKE mode

Take mode allows the user to connect or disconnect multiple outputs to an input at once. This mode is useful when the time delay is not allowed between multiple switching. The commands are only realized when the Take button is pressed.



Switching operation

Step 1. First, press and release the desired **source button**. The pressed source button and all destination buttons which are currently connected to the source lights up.



Step 2. Press and release the desired **destination buttons** which have to be (dis)connected to/from the selected source. The preselected destination buttons will blink.



Step 3. Press and release **Take** button; the selected input is switched to the selected output(s).



4.2.1.2. Front panel controls in AUTOTAKE mode

Autotake mode is useful when immediate actions must be done or fast switching is needed between sources on a particular destination. In this mode switching occurs immediately upon pressing one of the input selector buttons.



Switching operation

Step 1. Press and release the desired destination button. The pressed destination button and the actually connected source button light up green. If no source is connected (the output is muted) no source button will light up.



Step 2. Press and release the desired source button. The switch action will be executed immediately. Switching between sources to the selected destination can be done directly.



4.2.2. View Crosspoint State

User can check the current switching status on the front panel using front panel buttons. View mode is slightly different in TAKE or AUTOTAKE modes because of different switching philosophy of the two modes.

INFO: View mode does not mean, that the router has to be switched in different modes, viewing and switching can be done after each other, without pressing any special buttons.

View current state in TAKE mode

If the router is in TAKE mode, user can verify both input and output connections. In TAKE mode no accidental change can be done unless TAKE button is pressed.

Press and release a **source button**. Now the selected source button and all destination buttons that are currently connected to the selected source will light up. This informative display will remain active for 5 seconds, then all buttons turn unlit.



Sample drawing shows that Input 1 is currently connected to the Output 2, 3, and 5 ports.

If every source, destination and TAKE button is unlit (the unit is in TAKE mode, and no input was selected in the last 5 seconds), press and release a **destination button** to see its current state.



Now the source button, which is connected to the selected destination, will light up. If no source button is illuminated, the selected destination is in muted state. Upon pressing another destination button, the last state of the destination can be seen.

Sample drawing shows that Output 3 is connected to the Input 1 port.

View current state in AUTOTAKE mode

In AUTOTAKE mode only states of destinations can be viewed.

Press and release the desired **destination button**.



Now the source button, which is connected to the selected destination, will light up. If no source button is illuminated, the selected destination is in muted state. Upon pressing another destination button, the last state of the destination can be seen.

4.2.3. View Live Inputs and Attached Sinks

Step 1. Press and release **Signal Present** button.



Step 2. Input buttons will light up indicating that active TMDS clock signal is present on respective input connectors. Output buttons will also light up indicating that a powered monitor is attached to the output. The output circuit senses TMDS pull-up resistors on monitor side.

Step 3. Press and release **Signal Present** button to quit this mode.

Sample drawing shows that the current live inputs are 1 and 3, the current live output is the 8.

4.2.4. Preset Operations

4.2.4.1. Save or Load Presets

The unit has 32 user programmable presets. Each preset stores a configuration regarding all input connections for all outputs. All presets are stored in a non-volatile memory. The router keeps presets even in case of power down. Memory numbers are assigned to source buttons.



Saving a Preset in TAKE mode

Step 1. Press and release **Save Preset** button.



Step 2. Press and release the desired **source (memory address) button** (source 1 to 8).



Step 3. Press and release **Take** button. Now the current configuration is stored in selected memory.



ATTENTION! Preset save action always stores the current configuration for all outputs.

Loading a Preset in TAKE mode

Step 1. Press and release Load preset button.



Step 2. Press and release the desired source (memory address) button (source 1 to 8).



Step 3. Press and release Take button. Now the selected preset is loaded.



ATTENTION! Loading a preset always modifies all output states.

Saving a Preset in AUTOTAKE mode

Step 1. Press and release Save Preset button.



Step 2. Press and release the desired source (memory address) button (source 1 to 8). Now the current configuration is stored in the selected memory.



ATTENTION! Preset save action always stores the current configuration for all outputs.

Loading a Preset in AUTOTAKE mode

Step 1. Press and release LOAD PRESET button.

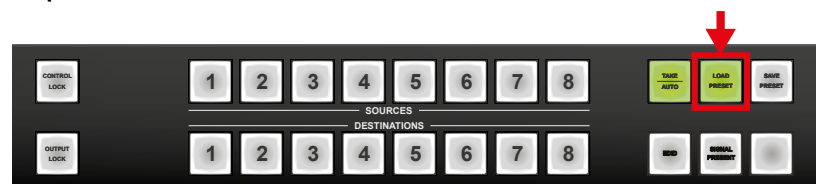

Step 2. Press and release the desired source (memory address) button (source 1 to 8). Now the selected preset is loaded.

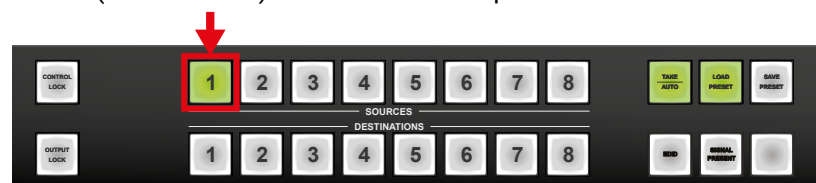

ATTENTION! Loading a preset always modifies all output states.

4.2.5. Output Lock

Using Lightware routers it is possible to lock a destination. This feature prevents an accidental switching to the locked destination in case of an important signal. Locking a destination means that no input selection or muting action can be executed on that particular destination.

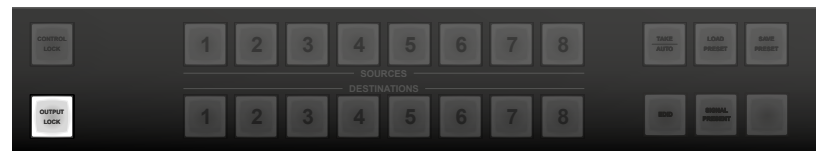

Destinations can be independently locked or unlocked. Locking a destination does not affect other destinations.

Output lock in Take mode

Step 1. Press and release the Output Lock button; it starts to blink and all the buttons of any locked destinations light up (view state).



Step 2. Press and release a destination button; it starts to blink (more destinations can be selected sequentially).



Step 3. Press and release Take button. The selected destinations are now locked.



Output lock in Autotake mode

Step 1. Press and release the required destination button. Now the selected destination button and the currently configured source button light up (view mode).



Step 2. Press and release the Output Lock button; it lights up in red, and lock function is activated at once. No source can be changed at the locked destination.



4.2.6. Control Lock

Front panel button operation can be enabled or disabled using **Control Lock** button, while RS-232 control is still enabled. If the button is unlit, front panel button operation is enabled. If it continuously illuminates red then front panel operations are inhibited.

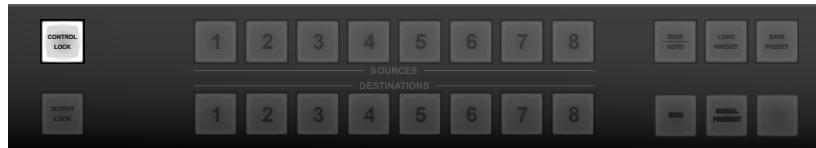

Press and release **Control Lock** button to toggle between the control lock states.

4.2.7. IP Settings

The Ethernet port can be configured on the front panel LCD menu or remotely through Controller software or the built-in website.

The factory default IP settings or DHCP mode can be activated quickly through front panel shortcut buttons. To reset the IP configuration perform the following:

Resetting the IP address

Reset to factory default IP configuration or to DHCP mode with front panel buttons.

Step 1. Switch the router to TAKE mode if used previously in AUTOTAKE mode by pressing TAKE button for 3 seconds (light will go off).

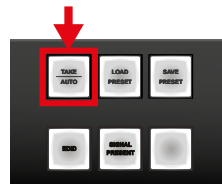

Step 2. Press the Control Lock button (Control Lock button lights in up red continuously).



Step 3. Press and keep pressed the Output Lock button (the current protocol indication will light up).



Step 4. Press and release the

a) **Load Preset** button to set the factory default IP settings:

IP address: 192.168.254.254
port number: 10001
subnet mask: 255.255.0.0
gateway: 192.168.0.1

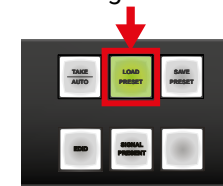

b) **Save Preset** button to set DHCP enabled:

IP address: Acquired with DHCP
port number: unchanged
subnet mask: Get from DHCP server
gateway: Get from DHCP server

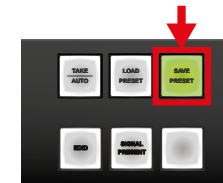

Step 5. A light sequence will occur to confirm the command. (Take/Auto, Load Preset and Save Preset buttons will light up one after the other)

Step 6. Wait about 5 seconds before connecting the router via Ethernet.

4.2.8. Control Protocols

Matrix routers can be controlled with multiple control protocols. Lightware routers have a special protocol, but to interoperate with third-party devices, a secondary protocol is also provided.

ATTENTION! Lightware Device Controller software and the built-in website works only with LW protocol (#1)!

The currently used protocol can be viewed or changed any time on the matrix front panel or with protocol commands.

Change (view) protocol on the front panel

Step 1. Switch the router to TAKE mode if used previously in AUTOTAKE mode by pressing TAKE button for 3 seconds. (light will go off).

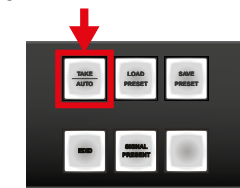

Step 2. Press **Control Lock** button for 3 seconds (it lights in up red continuously).



Step 3. Press and keep pressed the **Output Lock** button. Now the active protocols for the Serial and the Ethernet ports are displayed (view protocol):



One **source button** lights up according to the current protocol on the **Serial port** and the **Ethernet port**:

- Source#1 lights: Lightware protocol active.
- Source#2 lights: Protocol#2 is active.

Step 4.

- a) If you do not want to change the protocol, release the Output Lock button (view only).
- b) If you want to change the protocol on any interface, keep the Output Lock button pressed, and press the desired Source button, accordingly to the new protocol for that specific interface.

Step 5. If the control protocol for any interface has changed then a beep will sound to notify the change.

Change (view) protocol via remote connection

Connect to the matrix through any control interface, then use the commands described in the [Programmers' Reference](#) chapter.

4.3. Front Panel LCD Menu Operation

4.3.1. Menu concept

There are three operation modes of the LCD menu:

- Normal mode** Most settings can be done in this mode. It activates after powering on.
- EDID mode** Use this mode to set up the emulated EDID on the inputs, learn EDID form the outputs or to view the EDID memory. This mode is activated when **EDID** button is illuminated. You can enter this mode or exit by pressing the **EDID** button.
- Signal Present mode** This mode is for checking the presence of the display devices and incoming signals. It is activated when **Signal Present** button is illuminated. You can enter this mode or exit by pressing **Signal Present** button.

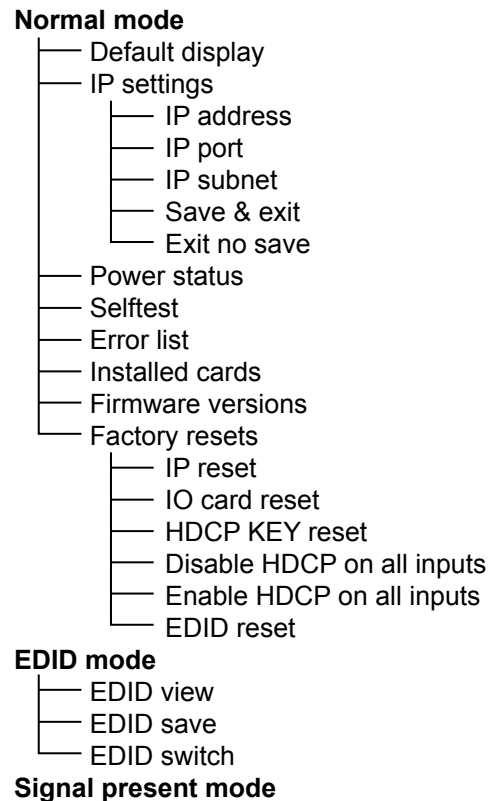

Press the **Left** or the **Right** button to jump between the menus and parameters Use the **Enter** or **Take** buttons to enter a menu or execute an item. The **Up** and **Down** buttons modify the values if modification is enabled.

4.3.2. Normal Mode

The normal mode has eight submenus that can be selected by pressing **Left** and **Right** buttons.

Default display

Default display activates after power up or after 10 sec idle from any menu in normal mode. This screen shows the current IP address, the IP port and the serial number of the matrix.

```

192.168.003.219
P10001 33004291
    
```

IP settings

Network related settings can be found in this menu. You can enter a submenu by pressing **Enter**, or change attributes and parameters by pressing **Up** and **Down** buttons.

IP address

It is possible to configure the system to use DHCP server by selecting DHCP instead of fixIP, and can set the IP address in case of fix IP mode.

```

IP ADDR  fixIP
192.168.000.104
    
```

IP port

User can set the IP mode and check the MAC address of the device.

```

IP PORT  10001
MAC:0080A391CE94
    
```

IP subnet mask

User can change the IP subnet mask of the device.

```

IP SUBNET
255.255.000.000
    
```

IP gateway address

User can change the IP gateway address of the device. After the desired modification, you have to press **Enter** again and select the **Save & Exit** item in the menu, then the new settings will be activated after a few seconds. If you select the **Exit no save** menu, then no modifications will be made.

```

IP GATEWAY
192.168.000.001
    
```

ATTENTION! New settings cannot be applied while an active connection is alive on the Ethernet port. If you get „OPERATION FAILED” message then please disconnect the remote TCP/IP sockets and try again.

Power status

You are able to check here the DC voltages and the internal temperature. If these values are out of the safe interval, you will get a warn message on the LCD screen regardless of what menu is selected.

```

PWR STATUS:  FRA
3.3V 5.0V 24C
    
```

Selftest

You can run selftest in the system started from this menu. There are three components in the test: I/O ports, memory and I2C devices.

```

SELFTEST  CPU
STOPPED
    
```

Error list

You can read out the error messages of the frame stored in the device memory in this menu.

```

ELIST:CPU
List is Empty!
    
```

Installed cards (Card ID slots)

This submenu shows the hardware description strings of the installed cards. You can view the installed cards by pressing **Up** and **Down** buttons. The position is shown in the top right corner. The possible values are:

```

CARD ID SLOT# MB
MX-DVI-MB8 SCH_1
    
```

- **MB:** Motherboard,
- **I1:** Input card slot,
- **O1:** Output card slot.

Firmware versions

It shows the firmware version numbers of the CPU, EDID, web server, web content and the front panel control board. Press the **Up** and **Down** buttons to view the desired firmware.

```

Firmwares:  CPU
Ver:2.5.0
    
```

Factory resets

Here you are able to recover the original factory settings if something went wrong. There are more factory reset options that you can select:

```
Factory resets..
```

IP reset	It resets the IP settings to factory default, see in the Factory Default Settings section.
IO card reset	Resets all settings related to the IO cards except the EDID routings.
HDCP key reset	Resets the internal HDCP key cache. It is useful when a source device fails because of too many downstream connections.
Disable HDCP on all inputs	Disables HDCP controls on all input ports.
Enable HDCP on all inputs	Enables HDCP controls on all input ports.
EDID resets	Resets the EDID on all input ports to factory default, see in the Factory Default Settings section.

4.3.3. EDID Mode

EDID mode is active when the EDID button is illuminated on the front panel. To enter or to exit from this mode press and release the EDID button. There are three submenus in this mode, use the **Right**, **Left** and **Enter** buttons to reach them.

EDID view

You can select an EDID with the UP and DOWN buttons and view it's short name. The short name contains the three-character long manufacturer code (so-called 'PNPID'), the resolution and frame rate of the preferred timing, detailed timing and the model name descriptor string. The following EDIDs can be selected:

```
EDID VIEW  0 1
SAM1920x1080@60.
```

O1 - O8	The EDID of the currently attached or the last attached sink device.
I1 - I8	The emulated EDIDs of the input ports.
M1 - M50	The stored Lightware EDIDs
M51-M99	49 user programmable memory slots.

EDID save

Lightware matrices have 49 user programmable EDID memory slots. You can learn and save an EDID from any output to one of the M51-M100 memory slots. You have to select the **desired output** and the **desired destination**, then press **Enter**. The EDIDs are stored in the non-volatile emergency memory. By default all user programmable memory slots are empty.

```
EDID SAV 0 1>M51
SAM1920x1080@60.
```

Press the **EDID** button to exit.

EDID switch

This menu is used to select the emulated EDIDs on the inputs. You have to specify the **EDID source** and the **desired input port** then press **Enter**.

```
EDID SW  0 2>I 1
LWR800x600@50.0H
```

If you select an output port as source then dynamic routing will be performed: the input will follow the changes of the output port. If there is no connected device on the selected output, then the EDID of the last attached sink will be emulated.

Press the **EDID** button to exit this menu.

4.3.4. Signal Present Mode

Signal present mode is active when **Signal present** button is illuminated. To enter or exit from Signal present mode you have to press this button.

```
I1I2I3I4I5I6I7I8
I1I2I3I4I5I6I7I8
```

The LCD screen shows the actual connections between the inputs and outputs. The second line represents the output and the first line represents the connected inputs.

If you are in Signal Present mode, the source and destination buttons show the actual state of the matrix. If a source button is illuminated then SCDT is present on that source. If a destination button is illuminated then a powered display is attached to this output (Hot Plug Detect signal is present). You can quickly check the cable connections with this feature.

4.4. Software Control Modes

User has more possibilities to control the device besides the front panel buttons. The following list contains the software control modes:

- **Built-in website** - you can connect and control to the device via the built-in website using Ethernet interface. For the details see the [Software Control – Using the Built-in Web](#) chapter.
- **Lightware Device Controller (LDC)** - you can connect to the device via our control software using RS-232 or Ethernet interfaces and control or configure the device as you wish. For the details see the [Software Control - Lightware Device Controller](#) chapter.
- **Protocol commands**: you can configure the device with reduced command set with our built-in command protocol LW2. For more details see the [Programmers' Reference](#) chapter.

5

Software Control – Using the Built-in Web

The MX8x8HDMI-Pro series matrix has a feature which allows to connect and control the matrix through a web browser. The controlling features are not so wide as in the case of Lightware Device Controller (LDC), but numerous information is displayed and many settings are available. The router's built-in website is compatible with the most common browsers and requires no additional software components.

- ▶ [ESTABLISHING THE CONNECTION](#)
- ▶ [THE LAYOUT OF THE BUILT-IN WEB](#)

5.1. Establishing the Connection

ATTENTION! Only one web page is allowed to open simultaneously to the same matrix. Other TCP/IP connections are prohibited while the web page is opened.

ATTENTION! If the connection is made through the router's Ethernet port, be sure that the computer is in the same network as the router. If the computer has multiple Ethernet connections (e.g. Wi-Fi and LAN connections are used simultaneously) you will have to know the IP address for the one that is used for controlling the matrix.

Step 1. Connect the matrix and the computer either via

- Ethernet, with LAN patch cable (to a Hub/Switch/Router), or
- Ethernet, with LAN cross cable (directly to Computer).

Step 2. Change to the desired IP settings if it is needed.

Step 3. Type the IP address to the address bar and press enter (factory default address is 192.168.254.254).

5.2. The Layout of the Built-in Web

The built-in web page allows almost the same controlling functions which are available via the LDC.

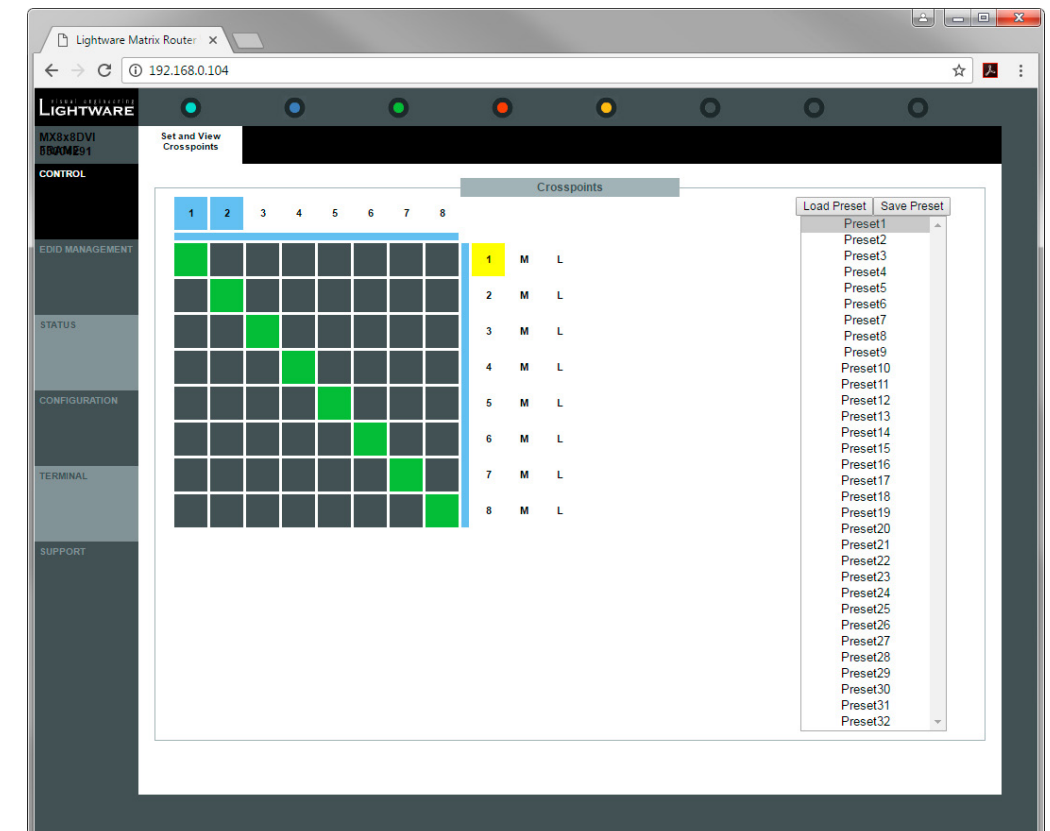

Built-in web page displaying the Crosspoint menu

6

Software Control - Lightware Device Controller

The device can be controlled by a computer through the RS-232 and Ethernet port using Lightware Device Controller (LDC). The software can be installed on a Windows PC or Mac OS. The application and the User's manual can be downloaded from www.lightware.com. The Windows and the Mac versions have the same look and functionality.

- ▶ [INSTALL AND UPGRADE](#)
- ▶ [RUNNING THE LDC](#)
- ▶ [CONNECTING TO A DEVICE \(DEVICE DISCOVERY WINDOW\)](#)
- ▶ [THE CROSSPOINT MENU](#)
- ▶ [TILE VIEW](#)
- ▶ [EDID MENU](#)
- ▶ [SETTINGS MENU](#)
- ▶ [TERMINAL WINDOW](#)

6.1. Install and Upgrade

INFO: After the installation, the Windows and the Mac application has the same look and functionality. This type of the installer is equal with the Normal install in case of Windows and results an updateable version with the same attributes.

Installation for Windows OS

Run the installer. If the User Account Control drops a pop-up message click **Yes**. During the installation you will be prompted to select the type of the installation: **normal** and the **snapshot** install:

Normal install	Snapshot install
Available for Windows and Mac OS	Available for Windows
The installer can update only this instance	Cannot be updated
Only one updateable instance can exist for all users	More than one different version can be installed for all users

Comparison of installation types

ATTENTION! Using the Normal install as the default value is highly recommended.

Installation for Mac OS

Mount the DMG file with double clicking on it and drag the LDC icon over the Applications icon to copy the program into the Applications folder. If you want to copy the LDC into another location just drag the icon over the desired folder.

Upgrading of LDC

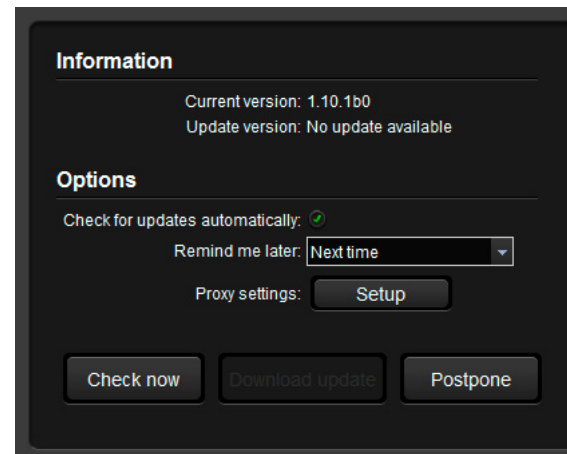

Step 1. Run the application.

The **Device Discovery** window appears automatically and the program checks the available updates on Lightware's website and opens the update window if the LDC found updates. The current and the update version number can be seen at the top of the window and they are shown in this window even with the snapshot install. The **Update** window can be also opened by clicking the **?** and the **Update** button.

Step 2. Set the desired update setting in the **Options** section.

When the Check for updates automatically option is selected, the LDC tries to find a new version after startup. The update can be postponed by setting a reminder; use the drop down list. The proxy settings can be set in a separate window.

Step 3. Click the **Download update** button to start. The updates can be checked manually by clicking the **Check now** button.

6.2. Running the LDC

The common way to start the software is double-click on the LDC icon. But the LDC can be run by command line parameters as follows:

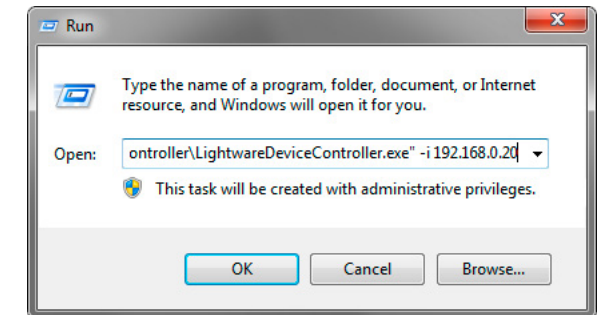

Connecting to a Device with Static IP Address

Format: LightwareDeviceController -i <IP_address>:<port>

Example: LightwareDeviceController -i 192.168.0.20:10001

The LDC is connected to a device with the indicated static IP address directly; the Device Discovery window is not displayed. When the port number is not set, the default port is used: 10001 (LW2 protocol). For LW3 devices use the 6107 port number.

Connecting to a Device via a Serial Port

Format: LightwareDeviceController -c <COM_port>:<Baud>

Example: LightwareDeviceController -c COM1:57600

The LDC is connected to a device with the indicated COM port directly; the Device Discovery window is not displayed. If no Baud rate is set the application will detect it automatically.

6.3. Connecting to a Device (Device Discovery Window)

There are three tabs for the different type of interfaces: Ethernet, Serial, and USB.

The Ethernet tab consists of two lists:

- **Favorite devices:** You can add any Lightware device that is connected via Ethernet and no need to browse all the available devices.
- **All devices:** The Lightware devices are listed which are available in the network.

Further Tools

The Tools menu contains the following options:

- **Log viewer:** The tool can be used for reviewing previously saved log files.
- **Create EDID:** This tool opens the Easy EDID Creator wizard which can be used for creating unique EDIDs in a few simple steps. Functionality is the same as the Easy EDID Creator, for the detailed information see the [Creating an EDID](#) section.
- **Demo mode:** This is a virtual MX-FR17 matrix router with full functionality built into the LDC. Functions and options are the same as a real MX-FR17 device.

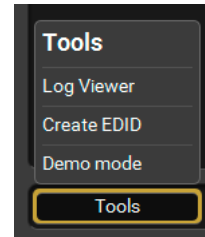

The Terminal window is also available by pressing its button on the bottom.

Establishing the Connection

Select the unit from the discovered Ethernet devices (see the picture on the right); if the device is connected via the RS-232 port click on the Query button next to the desired serial port to display the device's name and serial number (see the picture below). Double click on the device or select it and click on the green Connect button.

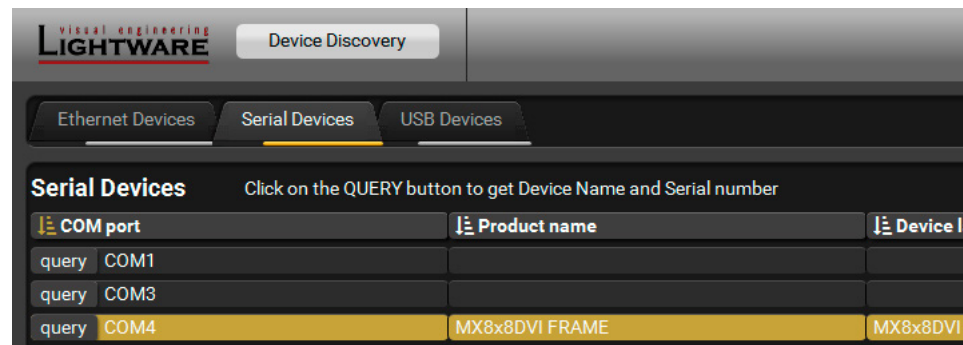

ATTENTION! When the device is connected via the local RS-232 port, make sure that LW protocol (#1) is set on the serial port. The protocol settings are available by the front panel buttons, see the [Control Protocols](#) section.

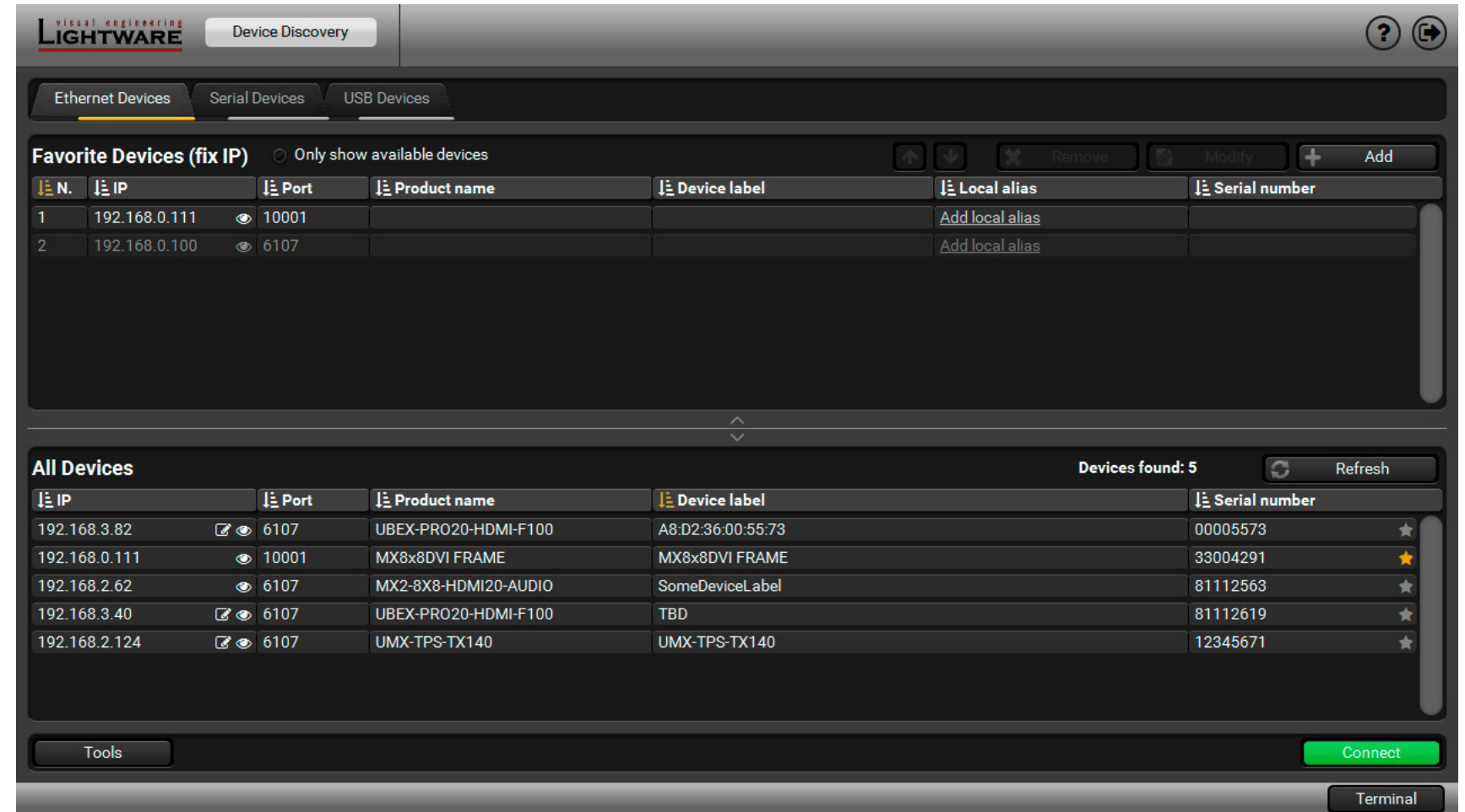

The Device Discovery Window

6.4. The Crosspoint Menu

6.4.1. Grid View

Grid view is a user-friendly graphical interface displaying the crosspoint state of the matrix router. This is an easy way to change between the input sources and output sinks.

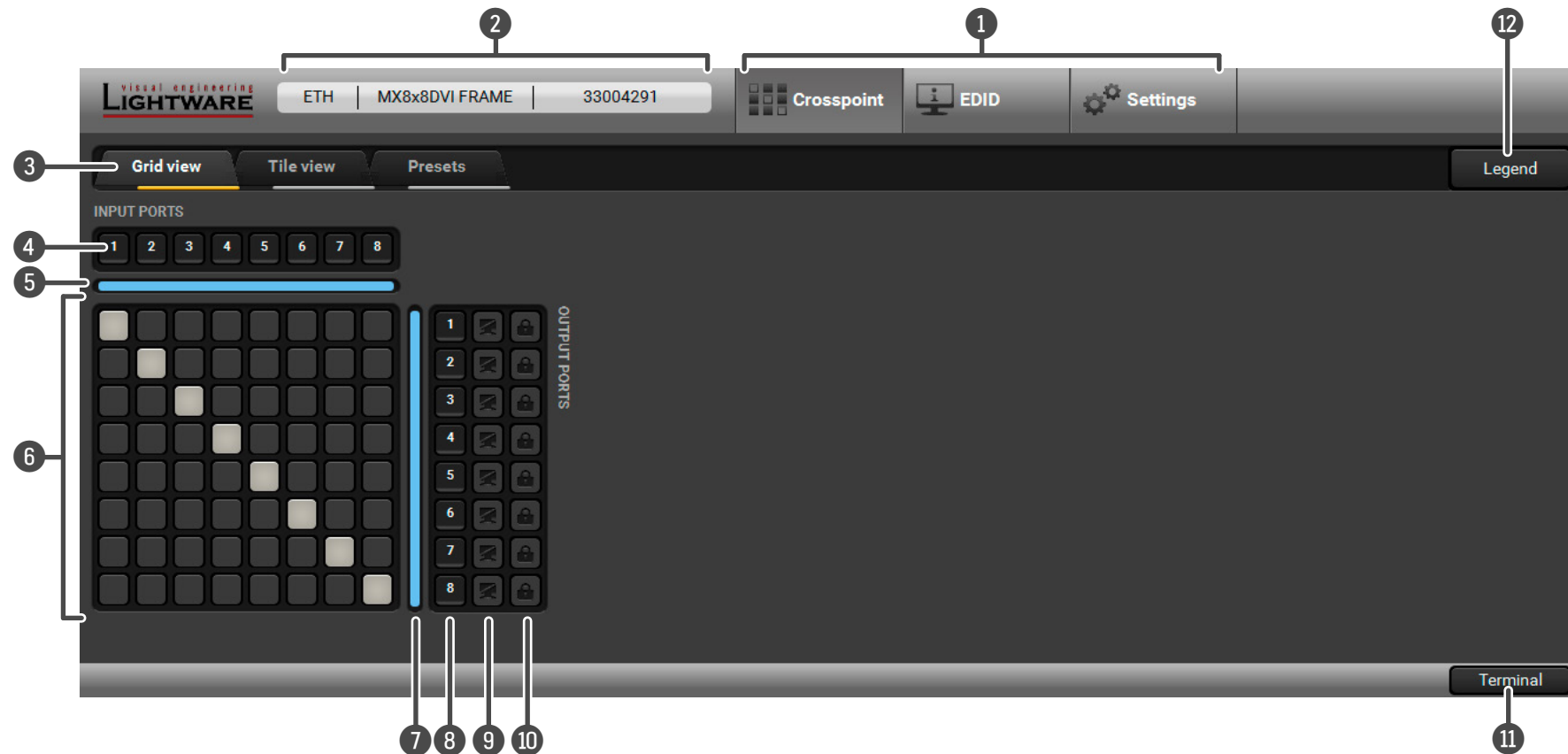

Grid View in the Crosspoint Menu

- ① **Main Menu** The available menu items are displayed. The active one is highlighted with a dark grey background color.
- ② **Information Ribbon** This label shows the interface type, the name and the serial number of the connected device. If the device has more than one interface, the ribbon shows only that one, which has made the connection. Click on the ribbon to open the device discovery window.
- ③ **Tab Selector Ribbon** The crosspoint and the settings menu contain more than one tab. Click on the desired one to select it. The yellow line shows which tab is the active one.
- ④ **Input Ports** Each number represents an input port. If the window size does not allow to display all the ports, pages can be turned by the left and right arrow buttons of the navigator.
- ⑤ **Input Board** The color of the line shows what kind of input board is installed (HDMI).
- ⑥ **Connections** Dark grey square means the port is not available. Light grey square means the port is available but there is no connection. White square means there is a connection between the input and the output port.
- ⑦ **Output Board** The color of the line shows what kind of output board is installed (HDMI).
- ⑧ **Output Ports** Each number represents an output port. If the window size does not allow to display all the ports, pages can be turned by the up and down arrow buttons of the navigator.
- ⑨ **Mute Buttons** Outputs can be easily muted by clicking on the mute button.
- ⑩ **Lock Buttons** For the prevention of the unwanted switching, outputs can be locked to any input.
- ⑪ **Terminal** This general-purpose terminal is created mainly for testing and debugging purposes. For more information see the [Terminal Window](#) section.
- ⑫ **Legend Button** Opens the Legend panel displaying the meaning of the applied symbols and colors of the Grid view.

6.4.1.1. The Legend Window

The meaning of the symbols and applied colors in the Grid view are described in this window:

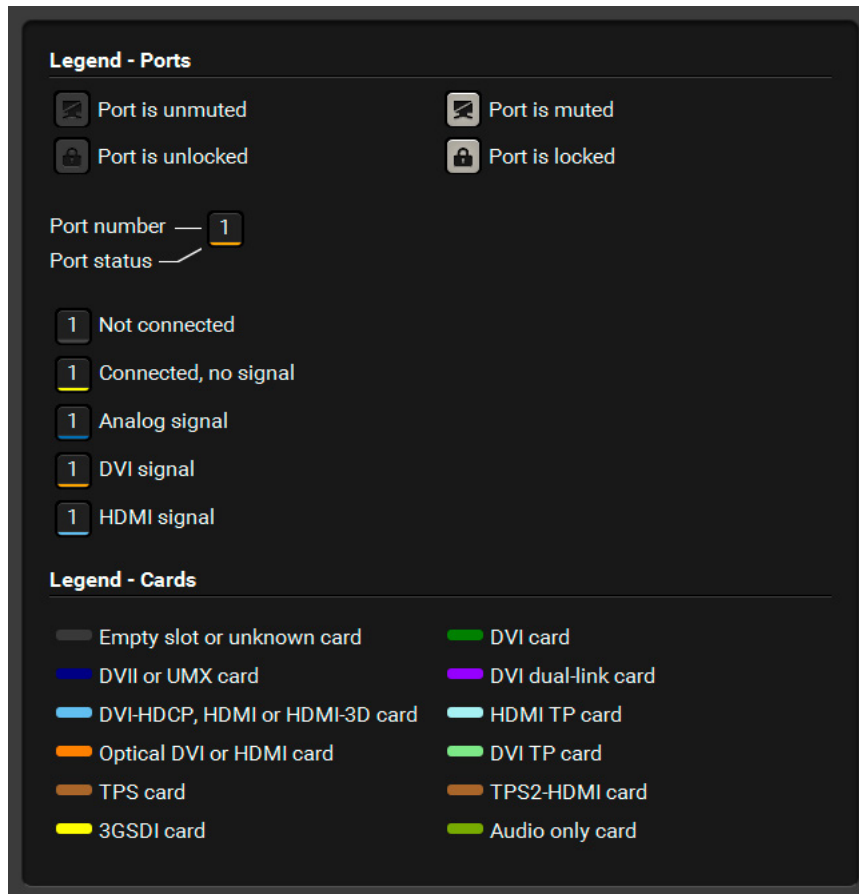

The Legend Window

6.4.1.2. Crosspoint Operations

Switching

For making a connection click on the desired square. If there is no connection between the desired input and output (the square is dark grey), the mouse pointer becomes a hand (link pointer) before the clicking. If the output port is not locked, the connection is made, the square becomes white and the cursor changes back to a pointer.



For example, input 8 is not connected to output 2 according to the first picture below. After the connection is established the square becomes light grey.

Muting the Outputs

Outputs can be easily muted by clicking on the button symbolized by a crossed monitor beside the output. This means that no signal is present at this output. If mute is active, the color of the button's background changes to white.

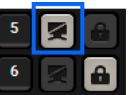

INFO: Inputs can be disconnected from any outputs (by protocol command). In this case, the crosspoint view will not show any white square for the disconnected output and the output will have no signal just like when muted. Click on a crosspoint square to connect the output again to an input.

Locking the Outputs

Outputs can be locked to any input. After locking an output to an input, no switching is permitted to this output unless it is unlocked again. If output lock is active, the color of the button's background changes to white.

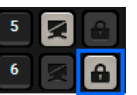

INFO: Loading a preset does not change either the lock state or the switch state of a locked output. If an output is locked to an input before preset loading it will also be locked to that input after preset loading, so locked outputs ignore the preset.

6.5. Tile View

The tile view is to display the input and output ports by tiles. Each tile means an input or output port and additionally shows the most important port and signal information. Thus, the user can check the status of many ports at the same time without clicking on a port or opening port settings window.

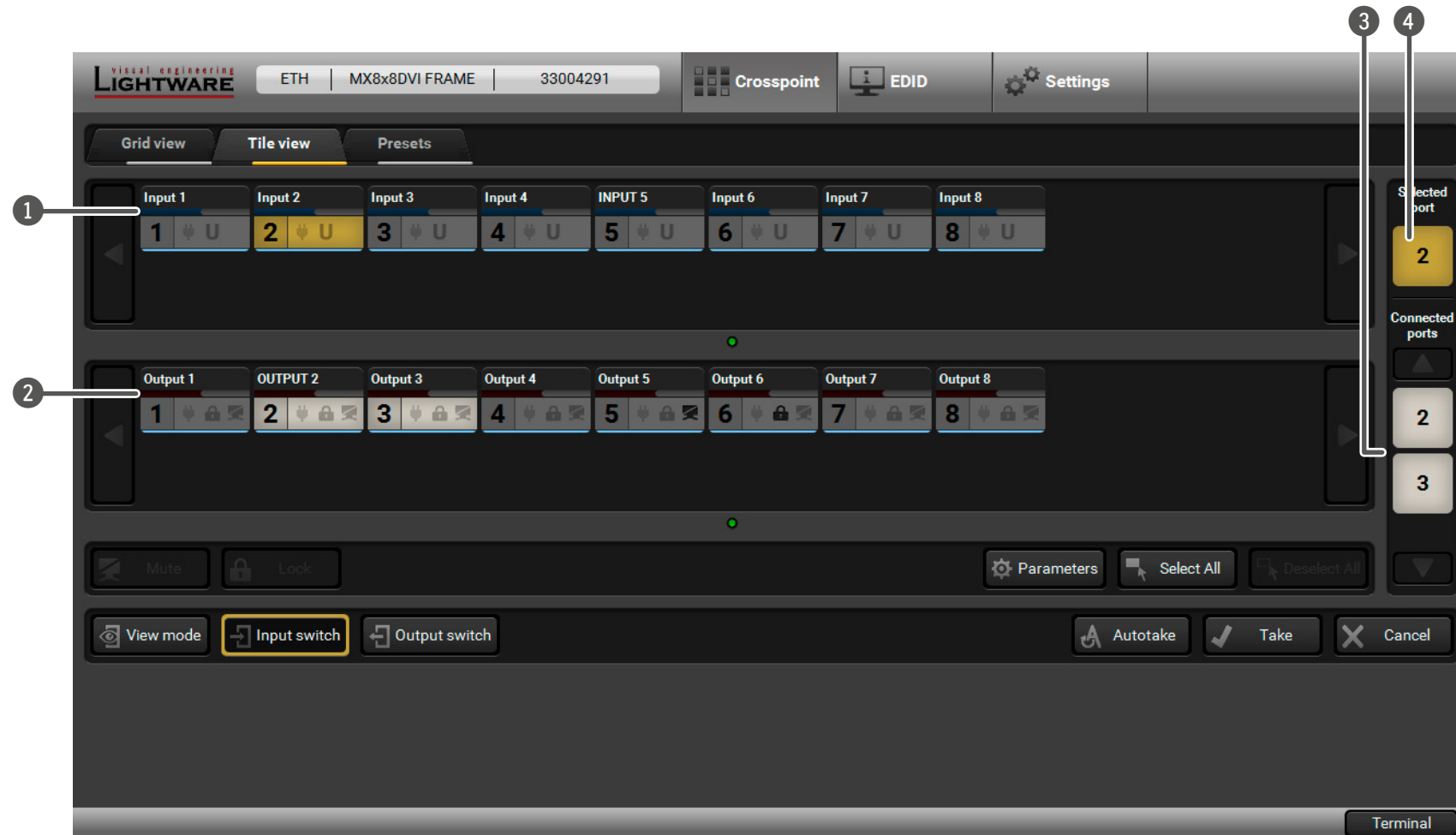

Tile View in the Crosspoint Menu

Legend

- 1 **Input Ports** Each tile represents an input port. If the window size does not allow to display all the ports, pages can be turned by the left and right arrow buttons.
- 2 **Output Ports** Each tile represents an output port. If window size does not allow to display all the ports, pages can be turned by the left and right arrow buttons.
- 3 **Connected Port(s)** Those ports are listed (with white background) on the port bar, which are connected to the Selected port.
- 4 **Selected Port** Last selected port is displayed with a yellow background on the port bar. Press the button to open the port settings window.

Control Buttons

- Mute** Muting or unmuting the selected output port(s)
- Lock** Locking or unlocking the selected output port(s)
- View mode** Selecting the View mode
- Input switch** Selecting the Input switch mode
- Output switch** Selecting the Output switch mode
- Parameters** Displaying the port settings window
- Select All** Selecting all ports (only in output switch mode)
- Deselect All** Deselecting all ports (only in output switch mode)
- Autotake** Toggling the Autotake mode ON/OFF
- Take** Executing the crosspoint changes in Take mode

6.5.1. Port Tiles

The colors of the port tiles and the displayed icons represent different states and information:

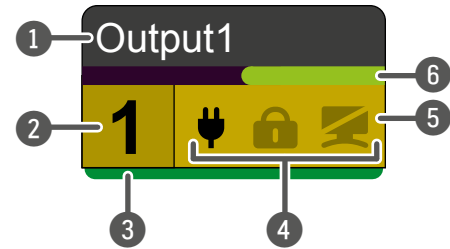

- 1 Port name
- 2 Port number
- 3 Board type
- 4 State indicators
- 5 Background color
- 6 Signal present indicator
green: present
grey: not present

Background Colors (Port State)

The colors of the port tiles represent different states of the port as follows:

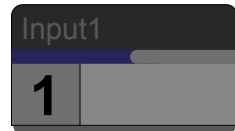

Dark grey
Port is not available
(no board is installed)

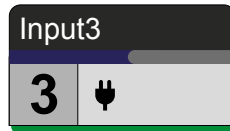

White
Connected port

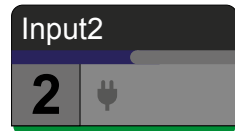

Light grey
Port is available

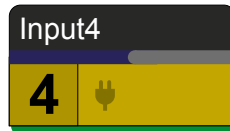

Yellow
Selected port

State Indicators

Icon	Icon is not displayed	Icon is grey	Icon is black
	No information is available about the connection status	Port is available but inactive	Output ports: Port is available and sink is connected (hotplug detected) Input ports: Port is available and source is connected (power +5V detected)
	-	Port is unmuted	Port is muted
	-	Port is unlocked	Port is locked

Port Parameters

Select the desired port and press the **Parameters** button; a window pops up where the current port name can be set.

TIPS AND TRICKS: The parameters window can be also opened by selecting the desired port and click on its button on the port bar.

6.5.2. Display Modes

View Mode

The mode allows to display the current crosspoint-state. The crosspoint cannot be changed in this mode but port settings are available.



Input Switch Mode

The mode can also be named as **Input priority-mode**: an input port has to be selected at first then the connected output port(s) is/are shown. Thus, the output port(s) connected to the input port can be changed.



Output Switch Mode

This mode can also be named as **Output priority-mode**: an output port has to be selected at first then connected input port is shown. Thus, the output port connected to the input port can be changed. Output ports can be (un)locked, (un)muted only in Output switch mode.



6.5.3. Crosspoint Operations

Switching in Take Mode

The black outlined **Autotake** button means this mode is active. Any crosspoint change – (dis)connecting ports to/from the previously selected port – is executed only after pressing the **Take** button. Following steps describe the process of the switching:



- Step 1.** Press the desired **Input switch** or **Output switch** button to select switching mode.
- Step 2.** Select the desired **port**; it will be highlighted with yellow color and displayed on the port bar on the right, too.
- Step 3.** Connected port(s) is/are highlighted with white color and displayed on the port bar on the right, too.
- Step 4.** Create the desired **crosspoint settings** by (de)selecting the ports; they will start to blink.
- Step 5.** Press **Take** button to execute changes or **Cancel** to ignore the operations.

INFO: Take mode remains active until it is switched off. Selecting another view mode or menu does not change the Take/Autotake mode state.

Switching in Autotake Mode

The yellow outlined **Autotake** button means this mode is active. Any crosspoint change – (dis)connecting ports to/from the previously selected port – is executed immediately after pressing the port button. Following steps describe the process of the switching:



- Step 1.** Press the desired **Input switch** or **Output switch** button to select switching mode.
- Step 2.** Select the desired **port**; it will be highlighted and displayed on the port bar on the right, too.
- Step 3.** Connected ports are highlighted with white color and displayed on the port bar on the right, too.
- Step 4.** Create the desired crosspoint settings by (de)selecting the ports; the changes are executed immediately.

INFO: Autotake mode remains active until it is switched off. Selecting another view mode or menu does not change the Take/Autotake mode state.

6.5.4. Port Properties and Settings

Output port properties window

Click on the number of the desired port in case of grid view or on the headline of the port in case of tile view to open the port properties window. Audio and video signal status information and the most important parameters are displayed. HDMI/DVI modes, colorspace, color range, LPCM subsample, and HDCP settings are available from this menu.

The screenshot shows the 'Output port properties window' with the following sections:

- Apply changes to:** Current output All outputs
- Reload factory defaults to:**
- Rename port to:**
- Set Signal Properties**
 - Mode:
 - Colorspace:
 - Color range:
 - LPCM subsample:
 - HDCP:
- Display**
 - HDMI capable: Yes
 - HDCP capable: Yes
 - HDCP repeater: No
 - Audio capabilities: Yes
 - Supported colorspaces: RGB YUV 4:4:4 YUV 4:2:2
 - Supported PCM frequencies: 32 44 48 kHz
 - Display manufacturer: Samsung Electric Company
 - Display type: T24B301
 - Display resolution: 1920x1080@60.0Hz
 - Deep Color support: 30 bit 36 bit
 - YUV support on DC: Yes
- General**
 - Monitor present (Receiver sense): Present
 - Output signal (HDMI/DVI): HDMI
 - Active signal: Present
 - HDCP: None
 - HotPlug Detect: Present
- Audio Signal Info**
 - Format: PCM
 - Sampling frequency: 48 kHz
 - Channels: 2 ch
- Video Signal Info**
 - Resolution: 1680x1050p60
 - Scan: Progressive
 - Colorspace: RGB
 - Vsync: 60 Hz
 - Hsync: 64.9 kHz
 - Vertical sync polarity: Positive
 - Horizontal sync polarity: Negative
 - Pixel clock stable: PLL locked
 - Pixel repetitions: No repetition
 - Aspect ratio: Unknown
 - Dimension: 2D video

You can customize the name of the port by **Rename** button. Factory default settings for current output or all outputs can be recalled by selecting **Current output** and **All outputs** buttons.

Input port properties window

Click on the number of the desired port in case of grid view or on the headline of the port in case of tile view to open the port properties window. Signal status information and the most important parameters are displayed. Input equalization, color range, and HDCP settings are available from this menu. Frame detector, Lightware's diagnostic tool for debugging purpose is also available on the panel.

You can customize the name of the port by **Rename** button. Factory default settings for current input or all inputs can be recalled by selecting **Current input** and **All inputs** buttons. By pressing **Switch this input to all outputs** button current input port is directed to all outputs.

6.5.5. Frame Detector

The ports can show detailed information about the signal like blanking intervals and active video resolution. This feature is a good troubleshooter if compatibility problems occur during system installation. To access this function, open the port properties window and click on Frame detector button.

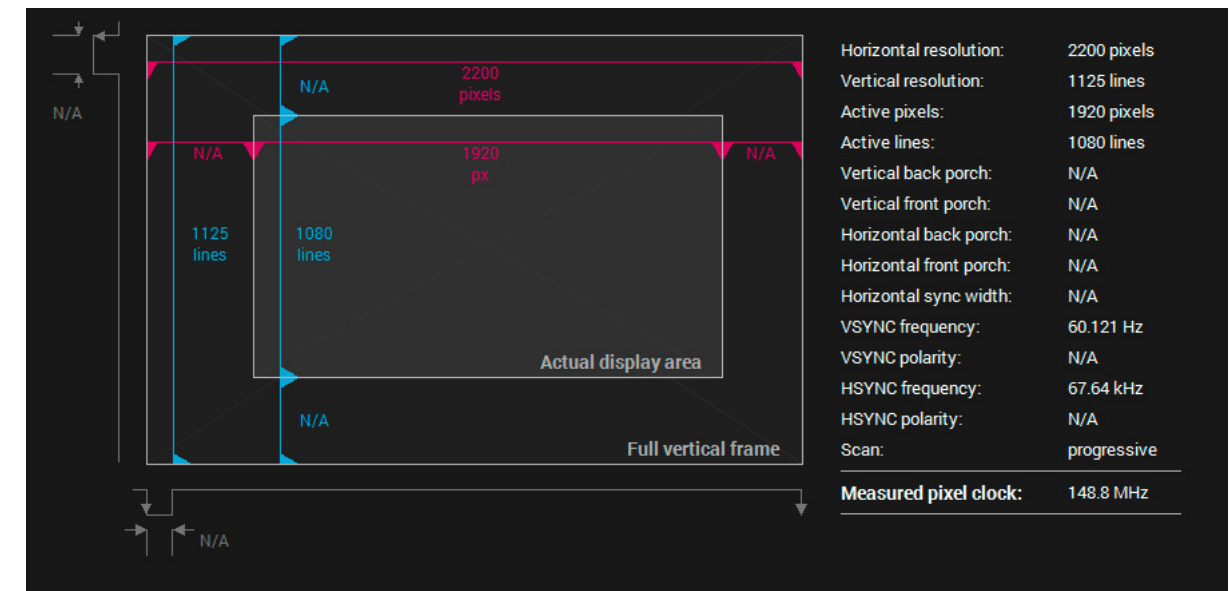

Frame Detector Window

Lightware's frame detector function works like a signal analyzer and makes possible to determine the exact video format that is present on the port, thus helps to identify many problems. E.g. actual timing parameters may differ from the expected and this may cause some displays to drop the picture.

Frame detector measures detailed timings on the video signals just like a built-in oscilloscope, but it is much more easy to use. Actual display area shows the active video size (light grey). Dark grey area of the full frame is the blanking interval which can contain the info frames and embedded audio data for HDMI signals. Shown values are measured actually on the signal and not retrieved only from the HDMI info frames.

6.5.6. Presets

Preset operations can be done in **Crosspoint** submenu on the **Preset tab**. Each Lightware matrix routers has 32 preset memories that can be loaded and saved at any time.

INFO: A preset setting stores a full configuration of all outputs. The preset loading has an effect on every output, except the locked ones.

Preset Preview

A preset can be selected by pressing its button on the left. The **Show preview on crosspoint** button will show the crosspoint of the input and output ports.

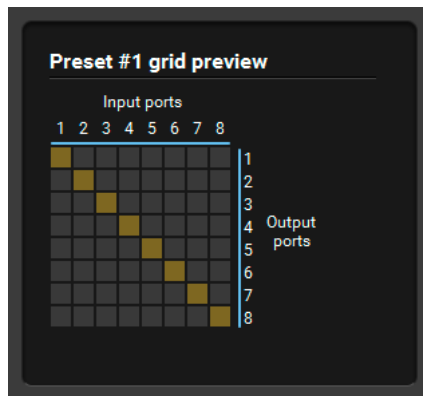

Loading a Preset

- Step 1.** Select the **Presets** tab from Crosspoint menu.
- Step 2.** Select the **preset memory** (Preset1... Preset32) you want to load.
- Step 3.** Press the **Load** button; the preset is loaded.
- Step 4.** The new I/O configuration is displayed in Grid view.

Saving a Preset

- Step 1.** Arrange the desired crosspoint connections.
- Step 2.** Select the **preset memory** (Preset1...Preset32) where you want to save your current crosspoint connections.
- Step 3.** Press **Save** button below Preset preview list.
- Step 4.** A confirmation message is displayed on the information bar; the preset is stored.



The Presets Tab

Renaming a Preset

- Step 1.** Select the **preset memory** (Preset1...Preset32) you want to rename.
- Step 2.** Type the desired name and press **Rename Preset** button; the new name is stored.

6.6. EDID Menu

The Advanced EDID Management is available in the EDID menu. There are two panels: left one contains Source EDIDs, right one contains Destination places where the EDIDs can be emulated or copied.

Sources and Destinations

- **Factory EDID** list shows the pre-programmed EDIDs (F1-F50).
- **Dynamic EDID** list shows the display device connected to the device's outputs. The unit stores the last display devices' EDID on either output, so there is an EDID shown even if there is no display device attached to the output port at the moment.
- **User memory** locations (U1 – U50) can be used to save custom EDIDs.
- **Emulated EDID** list shows the currently emulated EDID for the inputs. The source column displays the memory location that the current EDID was routed from.

The source reads the EDID from the Emulated EDID memory on the INPUT port. Any EDID from any of the User/Factory/Dynamic EDID lists can be copied to the user memory.

EDID Emulation Types

- **Static EDID emulation:** an EDID from the Factory or User EDID list is selected. Thus, the Emulated EDID remains the same until the user emulates another EDID.
- **Dynamic EDID emulation:** it can be enabled by selecting a slot from the Input 1..Input 16 EDID memory. The attached monitor's EDID is copied to the input; if a new monitor is attached to the output, the emulated EDID changes automatically.

The screenshot shows the EDID Menu interface with the following data:

Memory	Manuf.	Resolution	Monitor Name
U1#51	SAM	1920x1080@60.0Hz	T24B301
U2#52			
U3#53			
U4#54			
U5#55			
U6#56			
U7#57	LWR	800x600@50.0Hz	800x600@50
U8#58			
U9#59	FRI	1920x1080@50.0Hz	Encore
U10#60			
U11#61			
U12#62			
U13#63			
U14#64			
U15#65			
U16#66			
U17#67			
U18#68			
U19#69			

EDID Inputs	Manuf.	Resolution	Monitor Name	Source
Input 1	LWR	1680x1050@59.99Hz	1680x1050@60	F25
Input 2	SAM	1920x1080@60.0Hz	T24B301	D01
Input 3	LWR	800x600@74.99Hz	800x600@75	F06
Input 4	LWR	800x600@50.0Hz	800x600@50	D02
Input 5	LWR	1400x1050@75.0Hz	1400x1050@75	F24
Input 6	SAM	1920x1080@60.0Hz	T24B301	D01
Input 7	SAM	1920x1080@60.0Hz	T24B301	D01
Input 8	LWR	1400x1050@75.0Hz	1400x1050@75	F24

The EDID Menu

6.6.1. EDID Operations

Changing the Emulated EDID

- Step 1.** Choose the desired **EDID list** (source panel) and select an EDID.
- Step 2.** Press the **Emulated** button on the top of the Destination panel.
- Step 3.** Select the desired **ports** on the right panel (one or more ports); the EDID(s) will be highlighted with a yellow cursor.
- Step 4.** Press the **Transfer** button to change the emulated EDID.

Learning an EDID

The process is the same as changing the emulated EDID; the only difference is the Destination panel: press the **User** button. Thus, one or more EDIDs can be copied into the user memory either from the factory memory or from a connected sink (Dynamic).

Exporting an EDID

ATTENTION! This function is working on Windows and Mac OS X operating systems and under Firefox or Chrome web browsers only.

Source EDID can be downloaded as a file (*.bin, *.dat or *.edid) to the computer.

- Step 1.** Select the desired **EDID** from the Source panel (the line will be highlighted with yellow).
- Step 2.** Press the **Save** button to open the dialog box and save the file to the computer.

Importing an EDID

Previously saved EDID (*.bin, *.dat or *.edid file) can be uploaded to the user memory:

- Step 1.** Press the **User** button on the top of the Source panel and select a memory slot.
- Step 2.** Press the **Upload** button below the Source panel.
- Step 3.** Browse the file in the opening window then press the **Open** button. Browsed EDID is imported into the selected User memory.

ATTENTION! The imported EDID overwrites the selected memory place even if it is not empty.

Deleting EDID(s)

The EDID(s) from User memory can be deleted as follows:

- Step 1.** Press **User** button on the top of the Destination panel.
- Step 2.** Select the desired **memory slot(s)**; one or more can be selected (Select All and Deselect All buttons can be used). The EDID(s) will be highlighted with yellow.
- Step 3.** Press the **Delete selected** button to delete the EDID(s).

6.6.2. EDID Summary Window

Select an EDID from Source panel and press **Info** button to display EDID summary window.

The screenshot shows the EDID Summary Window interface. On the left, there is a vertical list of categories: General, Power Management, Gamma / Colors, Established Timings, Standard Timings, Preferred Timing Mode, 2nd Descriptor Field, 3rd Descriptor Field, 4th Descriptor Field, CEA General, CEA Video, CEA Audio, CEA Speaker Allocation, CEA HDMI VSDB, CEA HDMI Forum VSDB, CEA YCbCr 4:2:0 VDB, CEA YCbCr 4:2:0 Capability Map, CEA Colorimetry, CEA High Dynamic Range, and CEA Detailed Timing Descriptors. The 'General' category is selected and highlighted. On the right, the 'General' summary is displayed with the following details:

EDID version:	1
EDID revision:	3
Manufacturer ID:	SAM (Samsung Electric Company)
Product ID:	8E09
Monitor serial number:	Not present
Year of manufacture:	2012
Week of manufacture:	9
Signal interface:	Digital
Separate Sync H&V:	-
Composite sync on H:	-
Sync on green:	-
Serration on VS:	-
Color depth:	Undefined
Interface standard:	Not defined
Color spaces:	RGB 4:4:4 & YCbCr 4:4:4
Aspect ratio:	0.56
Display size:	52 cm X 29 cm

The EDID Summary Window

6.6.3. Editing an EDID

Select an EDID from Source panel and press Edit button to display Advanced EDID Editor window. The editor can read and write all descriptors, which are defined in the standards, including the additional CEA extension. Any EDID from the device's memory or a saved EDID file can be loaded into the editor.

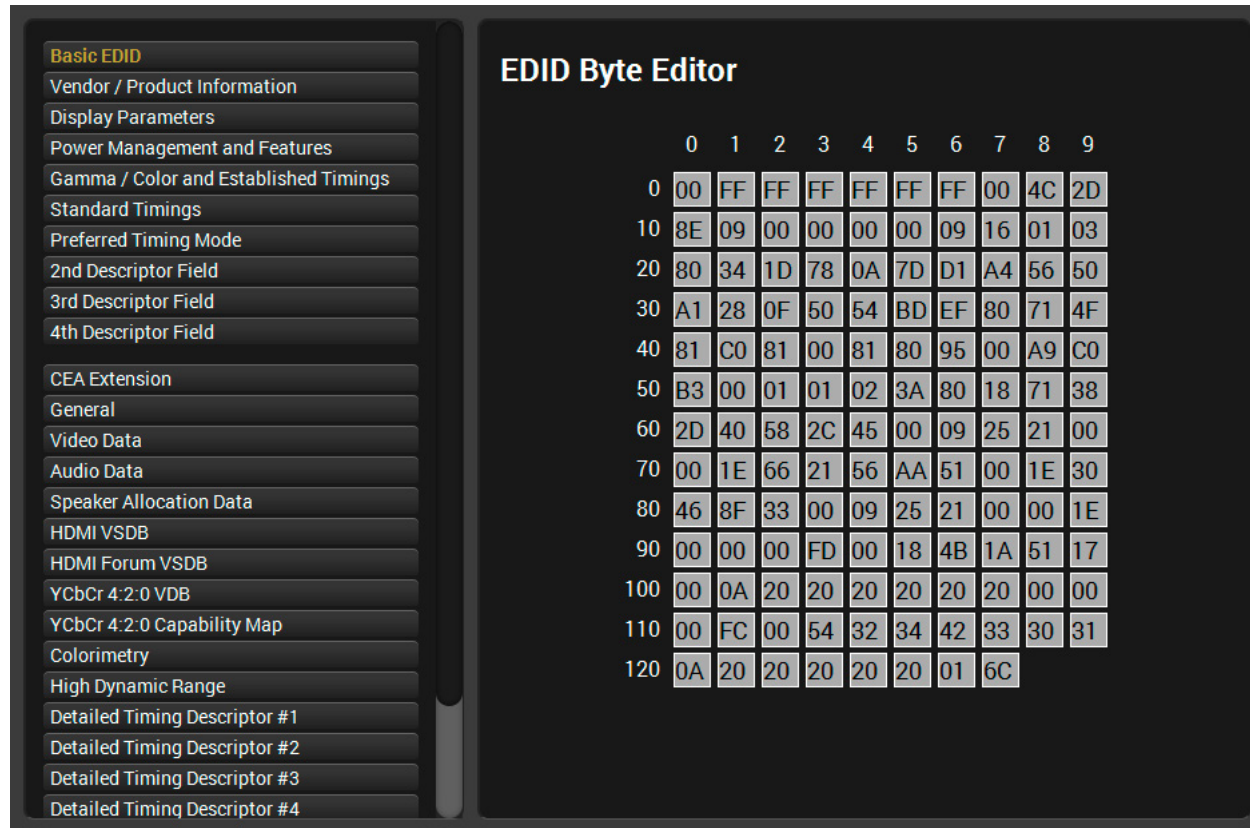

The EDID Editor Window

The software resolves the raw EDID and displays it as readable information to the user. All descriptors can be edited, and saved in an EDID file, or uploaded to the User memory. For more details about the EDID Editor please download the [EDID Editor Application Notes](#) document.

6.6.4. Creating an EDID

Since above mentioned Advanced EDID Editor needs more complex knowledge about EDID, Lightware introduced a wizard-like interface for fast and easy EDID creation. With Easy EDID Creator it is possible to create custom EDIDs in four simple steps.

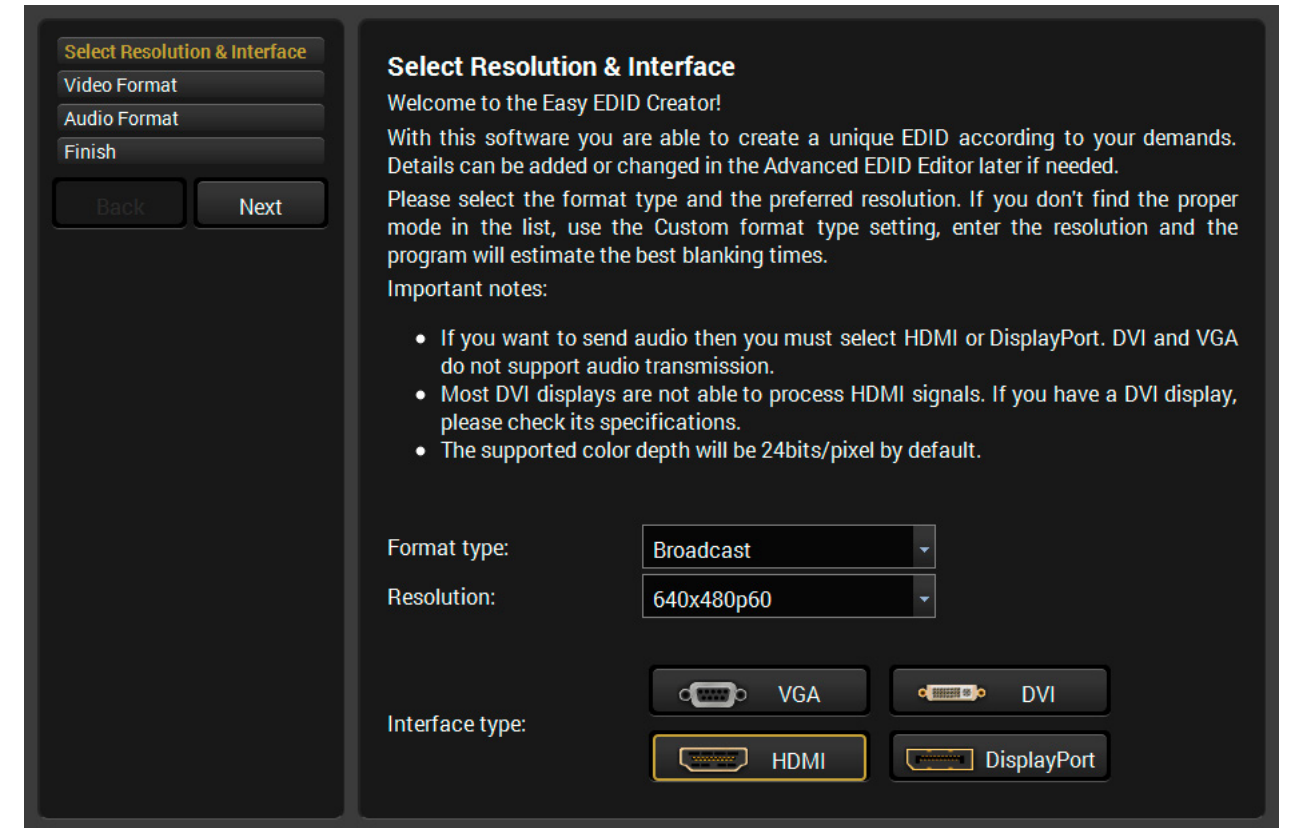

The Easy EDID Creator Window

By clicking on the **Create** button below Source panel, Easy EDID Creator is opened in a new window. For more details about the EDID Creator please download the [EDID Editor Application Notes](#) document.

6.7. Settings Menu

6.7.1. Configuration Tab

Settings about establishing the connection to the matrix are available on this tab.

IP Configuration

Getting the IP Address Automatically

The feature means that the matrix gets the IP address from the DHCP server on the LAN. If DHCP server is not present, the device gets an AutoIP address from 169.254.xxx.xxx domain automatically. Set BOOTP, DHCP and AutoIP settings according to your network requirements. Always press the **Apply settings** button to save changes.

INFO: Load default button restores the default network settings (fix IP) to the device: fix IP Address: 192.168.254.254, Subnet Mask: 255.255.0.0, Default Gateway: 0.0.0.0.

Static IP Configuration

In this case, connected device has an IP address configuration set up by the user/administrator. Depending on modified settings, you might need to restart the device and the Control Software. Always press the **Apply settings** button to save changes.

INFO: Load default button restores the default network settings (fix IP) to the device: fix IP Address: 192.168.254.254, Subnet Mask: 255.255.0.0, Default Gateway: 0.0.0.0.

TCP Port Configuration

Devices can be accessed via this TCP/IP port number with TCP connection. Port number can be modified to any number between 1025 and 65535 except the followings:

- 9999, 14000 - 14009, 30704, and 30718.
- To use a matrix with Barco Encore set the port to 23.
- To use a matrix with Vista Spyder set the port to 10001.

Always press the **Apply settings** button to save changes.

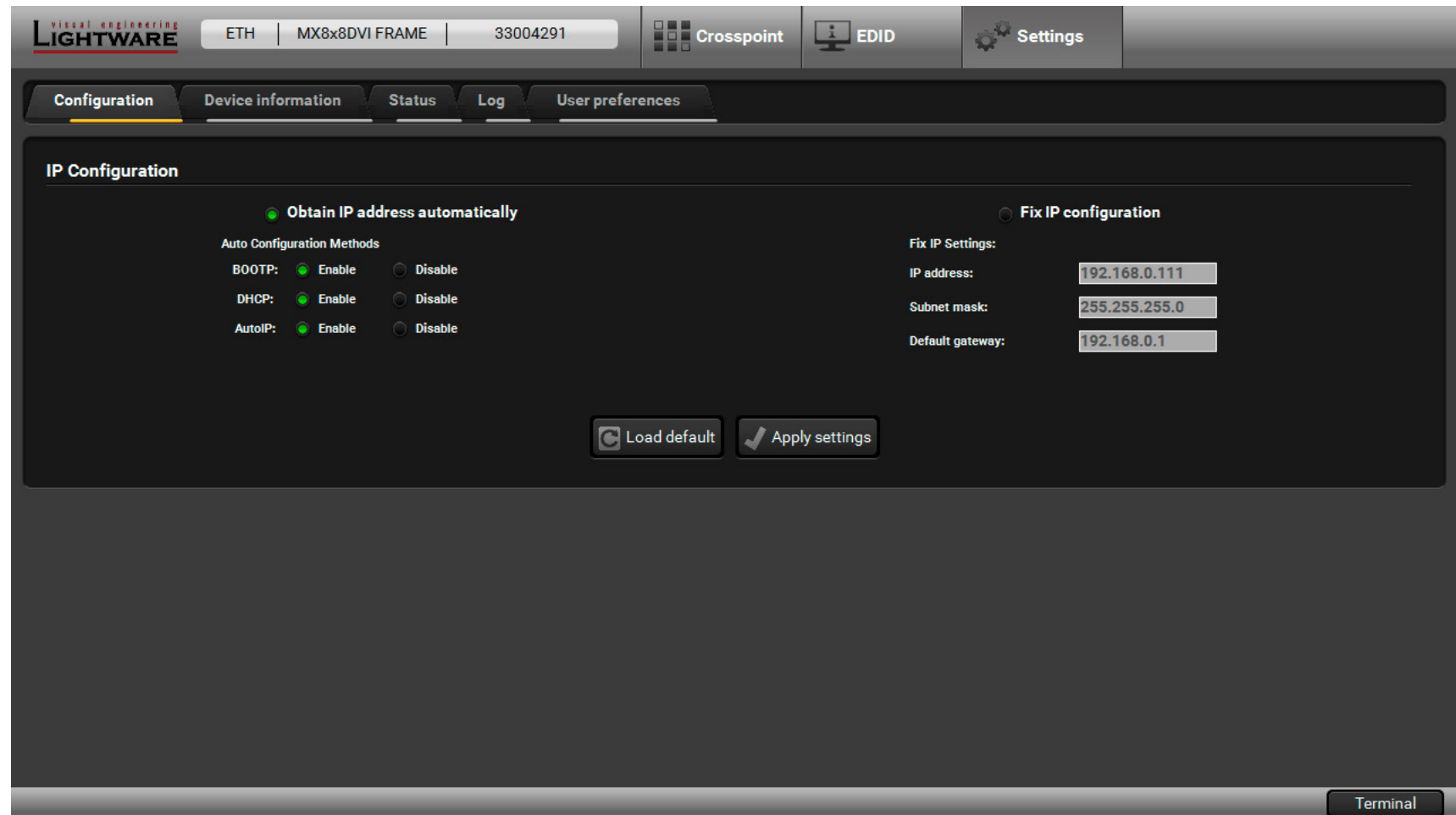

The Configuration Tab

6.7.2. Device Information Tab

Basic information is displayed about the device in this menu: Device type with serial number and the type of the installed boards with firmware and hardware version.

6.7.3. Status Tab

The voltage levels and temperature measured by the CPU of the device are shown. Press the **Refresh** button to show/update values.

6.7.4. Log Tab

Generating a Standard Report File

LDC is able to collect information from the device and save it to a report file. This information package can be sent to Lightware when a problem may arise with the device.

Download report

ATTENTION! When a report is necessary to generate, always let the devices be connected to the device, do not disconnect them. The Controller Software will collect information about the devices and about their status.

Step 1. Press the **Download report** button on the **Log** tab in the **Settings** menu:

Step 2. The **Save as** dialog box appears. Select the place where you want to save the report file. The default file name can be changed.

Step 3. LDC collects the needed information. This may take up to 5 minutes.

Step 4. When the process is finished, the folder is opened, where the file was saved. The report contains the following information:

- The current command protocol,
- The equipment type and serial number,
- Status of input/output ports,
- Installed controllers and I/O board types and firmware with versions,
- Network settings,
- EDID headers and status (emulated, dynamic, factory, user).

Generating a Custom Report File

The Controller Software is able to send a custom command file to the device. The command file can be generated by Lightware support. This is needed when some special commands have to be used for configuring or for special troubleshooting cases.

Generate report from file

Download report

Generate report from file

Slot Name	Card Name	Firmware Version	Hardware Version	Serial number
CPU Card	Web Content	FW:1.4.1		
CPU Card	Web Server	FW:1.1.6		
CPU Card	MX-CPU	FW:2.5.0		
Control Panel	MX-CP	FW:1.0.8		
CPU Card	MX-DVI-EDID	FW:2.3.5r		
MOTHERBOARD	MX-DVI-MB8		SCH_1.0 PCB_1.0	
SLOT 1	MX-DVI-HDCP-OB		SCH_1.1 PCB_1.1	
SLOT 2	MX-DVI-HDCP-IB		SCH_1.2 PCB_1.2	

The Device Information Tab

Parameter	Value	Range
3.3V	3.3V	[3V - 3.6V]
5V	5V	[4.5V - 5.5V]
Temp	31C	[0C - 50C]

The Status Tab

The Log Tab

6.7.5. User Preferences

The tab shows some settings in connection with the LDC displaying/working mode.

These settings are saved by the LDC and applied next time when the software is started (independently from the type of the matrix). The size of the LDC window is also restored from the last run.

6.8. Terminal Window

This general purpose terminal is intended mainly for testing and debugging purposes. When a successful connection is established with a router this terminal can be used either via serial RS-232, TCP/IP LAN or USB connection. All commands can be used here that are discussed in the programmer's reference. The command text can be typed directly.

By default commands are automatically surrounded by framing brackets. Every sent command and every received response gets an arrow (-> or <-) prefix, and has different font colors in order to help to distinguish.

The timecode in every row shows the exact time when the command was sent or the response received.

If the **Command framing** checkbox is unchecked, you can send multiple commands together, however in this case you have to type in the framing brackets manually.

The terminal can be also opened after starting the LDC - press the Terminal button on the Device discovery page on the bottom of the window.

TIPS AND TRICKS: The typed commands can be 'browsed' when the cursor is in the command line and you press the up button on the keyboard. The commands are stored until the LDC is closed.

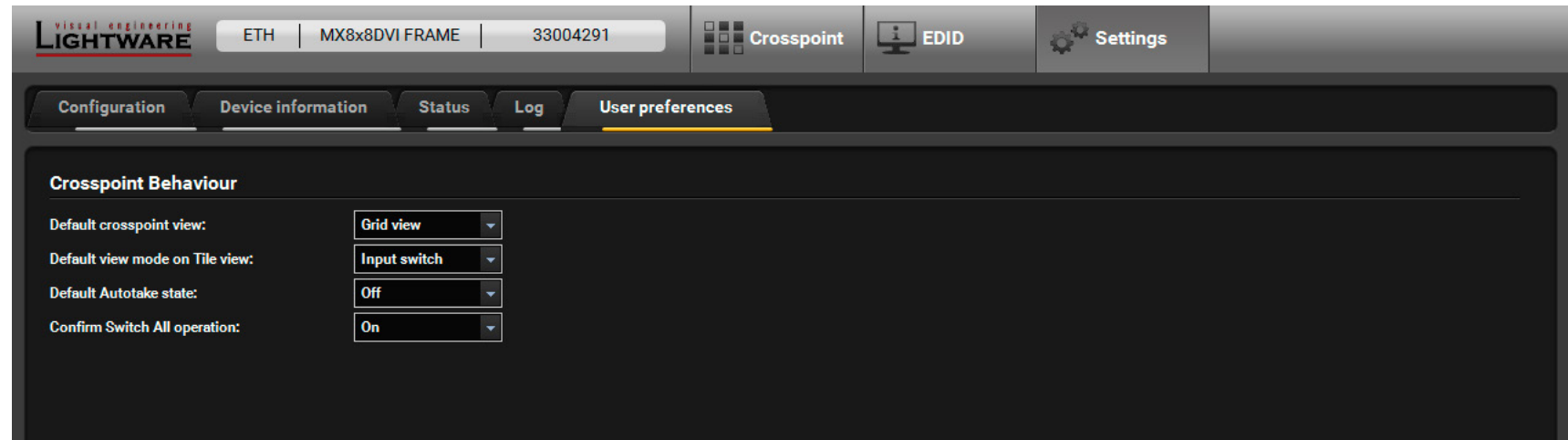

The User Preferences Tab

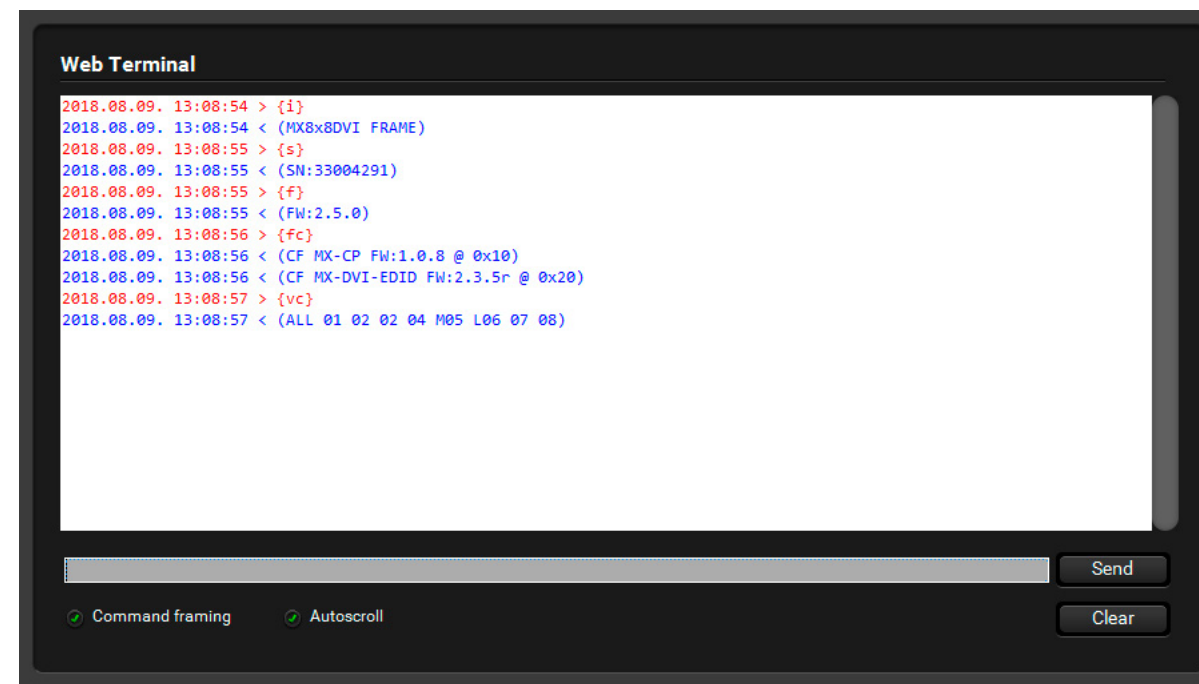

The Terminal Window

7

Programmers' Reference

ATTENTION! The matrix router supports below mentioned LW1 command protocol set only. Further LW2 and LW3 command sets are not supported.

The device can be controlled through a command set of protocol commands to ensure the compatibility with other Lightware products. The supported commands are described in this chapter.

- ▶ [PROTOCOL DESCRIPTION](#)
- ▶ [GENERAL COMMANDS](#)
- ▶ [PORT SETTINGS](#)
- ▶ [NETWORK CONFIGURATION](#)
- ▶ [EDID ROUTER COMMANDS](#)
- ▶ [PORT STATUS COMMANDS](#)
- ▶ [PROGRAMMERS' REFERENCE – QUICK SUMMARY](#)

7.1. Protocol Description

The device accepts commands surrounded by curly brackets - { } - and responds data surrounded by round brackets - () - only if a command was successfully executed.

Format	Explanation
<in>	Input number in 1 or 2 digit ASCII format (01, 5, 07, 16, etc.)
<out>	Output number in 1 or 2 digit ASCII format
<in ² >	Input number in 2 digit ASCII format (01, 02, 10, 12 etc.)
<out ² >	Output number in 2 digit ASCII format (01, 02, 10, 12 etc.)
<loc>	Location number in 1, 2 or 3 digit ASCII format
<id>	id number in 1 or 2 digit ASCII format
<id ² >	id number in 2 digit ASCII format
CrLf	Carriage return, Line feed (0x0D, 0x0A)
·	Space character (0x20)
→	Each command issued by the controller
←	Each response received from the router

7.2. General Commands

7.2.1. View Product Type

Description: The device responds its name.

Format	Example
Command {i} Response (<PRODUCT_TYPE>CrLf	→ {i} ← (MX8x8DVI FRAME)

Explanation: The connected device is a MX8x8DVI-HDCP-PRO.

Legend: <PRODUCT_TYPE> shows type.

7.2.2. View Firmware Version of the CPU

Description: View the CPU firmware revision.

Format	Example
Command {f} Response (FW:<FW_VER><s>)CrLf	→ {f} ← (FW:2.5.0)

Legend: <FW_VER> is the firmware version. It is followed by <s> string which may indicate special versions.

7.2.3. View Serial Number

Description: The device responds its 8-digit serial number.

Format	Example
Command {s} Response (SN:<SERIAL_N>)CrLf	→ {s} ← (SN:33004291)

7.2.4. Compile Time

Description: Returns the date, when the microcontroller firmware was compiled, and the build number.

Format	Example
Command {CT} Response (Complied: <DATE&TIME>, <BUILD no>)CrLf	→ {ct} ← (Compiled: Nov 25 2013 12:40:07, build: 1737)

7.2.5. View Installed Boards

Description: Shows the hardware name and revision of the installed cards.

Format	Example
Command {is} Response (SL#•0•<MB_DESC>)CrLf (SL#•1•<OB_DESC>)CrLf (SL#•2•<Empty_Slot>)CrLf (SL#•3•<Empty_Slot>)CrLf (SL#•4•<Empty_Slot>)CrLf (SL#•5•<IB_DESC>)CrLf (SL#•6•<Empty_Slot>)CrLf (SL#•7•<Empty_Slot>)CrLf (SL#•8•<Empty_Slot>)CrLf (SL•END)CrLf	→ {is} ← (SL# 0 MX-DVI-MB8 SCH_1.0 PCB_1.0) ← (SL# 1 MX-DVI-HDCP-OB SCH_1.1 PCB_1.1) ← (SL# 2 Empty Slot) ← (SL# 3 Empty Slot) ← (SL# 4 Empty Slot) ← (SL# 5 MX-DVI-HDCP-IB SCH_1.2 PCB_1.2) ← (SL# 6 Empty Slot) ← (SL# 7 Empty Slot) ← (SL# 8 Empty Slot) ← (SL END)

Explanation: The device reports the motherboard (slot 0), the output board (slot 1) and the input board (slot 5). Slot 2, 3, 4, 6, 7, 8 are only virtual slots and empty.

7.2.6. View Firmware for All Controllers

Description: Shows the firmware versions of all installed controllers.

Format	Example
Command {FC} Response (CF•<DESC>)CrLf (CF•<DESC>)CrLf ... (CF END)CrLf	→ {fc} ← (CF MX-CP FW:1.0.8 @ 0x10) (CF MX-DVI-EDID FW:2.3.5r @ 0x20) ← (SL END)

Explanation: The device has two control panels.

7.2.7. Restart the Device

Description: The device can be restarted without unplugging power.

Format	Example
Command {RST} Response (CPU_RESET...) (MX8x8DVI FRAME Ready!)	→ {RST} ← (CPU_RESET...) ← (MX8x8DVI FRAME Ready!)

Explanation: The device reboots.

7.2.8. Query Health Status

Description: Internal voltages and measured temperature values are shown.

Format	Example
Command {ST} Response (STAT•<DESC>)CrLf	→ {ST} ← (STAT 3.3V 5.0V 29V)

7.2.9. View Current Communication Protocol

Description: Shows the RS-232, TCP/IP communication protocol.

Format	Example
Command {P_?} Response (CURRENT•PROTOCOL•=#<x>)CrLf	→ {p_?} ← (CONTROL PROTOCOL = #1)

Explanation: The current communication protocol is Lightware protocol.

Legend:

No.	Control protocol
1	Lightware protocol
2	P#2 protocol

7.2.10. Set Communication Protocol

Description: Internal voltages and measured temperature values are shown.

Format	Example
Command {P_<x>} Response (PROTOCOL•#<x>•SELECTED!)CrLf	→ {p_1} ← (PROTOCOL #1 SELECTED!)

Explanation: The communication protocol is set to Lightware protocol.

7.2.11. Count HDCP Keys

Description: If there is an HDCP source on any input of the matrix, the matrix can ask the source whether it can handle <num> piece of sink devices.

	Format	Example
Command	{:HDCPTEST<in>@<num>}	→ {:hdcptest2@8}
Response	(HDCPTEST=SUCCESS)CrLf	← (HDCPTEST=SUCCESS)

Explanation: The source on the 2nd input can handle 8 HDCP sink devices.

Legend:

Identifier	Explanation
<in>	input port where the key counting will be executed
<num>	the number of the HDCP keys

7.2.12. Clear HDCP Key Cache

Description: The matrix stores the HDCP keys from the connected devices. These cached keys can be cleared with this command.

	Format	Example
Command	{:HDCPRESET}	→ {:hdcpreset}
Response	(DONE)CrLf	← (DONE)

Explanation: HDCP key cache is cleared.

INFO: This function is useful when too many keys were cached and a connected source device cannot accept so many keys.

7.3. Port Settings

7.3.1. Switch One Input to One Output

Description: Switch input <in> to output <out>.

	Format	Example
Command	{<in>@<out>}	→ {1@2}
Response	(O<out?>·I<in?>)CrLf	← (O02 I01)

Explanation: I2 input port is switched to O1 output port.

Legend:

<out>: O1 to O8 output ports

<in>: I1 to I8 input ports.

ATTENTION! The response of this command does not show if the output is muted. To check the mute status a separate query has to be used like {VC}. See the [View Connection State](#) section.

7.3.2. Switch One Input to All Outputs

Description: Switch input <in> to all outputs.

	Format	Example
Command	{<in>@0}	→ {1@0}
Response	(I<in?>·<ALL>)CrLf	← (I01 ALL)

Explanation: I1 input port is switched to all output ports.

7.3.3. Mute Specified Output

Description: Mute output <out>. The output signal is turned off.

	Format	Example
Command	{#<out>}	→ {#01}
Response	(1MT<out?>)CrLf	← (1MT01)

Explanation: O1 port is muted.

ATTENTION! Muting does not change the crosspoint's state but disables the output itself. This way the last connection can be easily restored with an unmute command. Switching a muted output does not unmute the output.

7.3.4. Unmute Specified Output

Description: Unmute output <out>.

	Format	Example
Command	{+<out>}	→ {+01}
Response	(0MT<out?>)CrLf	← (0MT01)

Explanation: O1 port is unmuted.

INFO: Unmuting an output makes the previous connection active as the crosspoint state has not been changed by the muting command, only the output was disabled.

7.3.5. Lock the Output

Description: Lock an output port. Output's state cannot be changed until unlocking.

	Format	Example
Command	{#><out>}	→ {#>01}
Response	(1LO<out?>)CrLf	← (1LO01)

Explanation: O1 output port is locked.

7.3.6. Unlock the Output

Description: Unlock an output port. The connection on output can be changed.

Format	Example
Command {+<<out>} Response (OLO<out?>)CrLf	→ {+<01} ← (OLO01)

Explanation: 01 output port is unlocked.

INFO: The device issues the above response regardless of the previous state of the output (either it was locked or unlocked).

7.3.7. View Connection State

Description: Viewing the crosspoint state of the device; showing the input port numbers connected to the outputs.

Format	Example
Command {VC} Response (ALL•<001>•<002>...<008>)CrLf	→ {vc} ← (ALL M01 L02 U03 04 05 06 07 08)

Legend: 001 to 008 show the corresponding output's connection state. If value <001> equals 01 it means that output 1 is connected to input 1.

State letters:

Letter	State	Example
L	Output is locked	L01
M	Output is muted	M01
U	Output is locked and muted	U01

Explanation: I1 input port is connected to the O1 output port, I2 is connected to O2, and so on. O1 output port is muted, O2 is locked, O3 is muted and locked.

7.3.8. View Mutes on All Outputs

Description: View muted outputs in the device.

Format	Example
Command {VM} Response (MUT•<001_state>•...•<008_state>)CrLf	→ {vm} ← (MUT 1 0 1 0 0 0 0 0)

Explanation: 01 and 03 output ports are muted.

7.3.9. Save Preset

Description: Save current ties to a preset memory location.

Format	Example
Command {\$<id>} Response (SPR<id>)CrLf	→ {\$1} ← (SPR01)

Explanation: Current ties is saved to memory location 1.

ATTENTION! The router saves the mute state of the outputs as well.

ATTENTION! Lock states are not saved. Lock state is assigned to the physical output of the router. Presets don't affect output locks.

7.3.10. Load Preset

Description: Load preset from memory location.

Format	Example
Command {%<id>} Response (LPR<id>)CrLf	→ {%01} ← (LPR01)

ATTENTION! The router loads the mute state of the outputs as well.

ATTENTION! Lock states are not loaded. Lock state is assigned to the physical output of the router. Presets don't affect output locks.

7.3.11. View Preset Without Loading

Description: View the specified preset without loading it.

Format	Example
Command {VP#<id>=?} Response (VP#<id>=•<001>•...•<008>)CrLf	→ {VP#1=?} ← (VP#1= M01 02 M03 04 05 06 07 08)

7.3.12. Name Presets

Description: Allows storing names for each preset. Any 16- byte long string is allowed.

ATTENTION! All characters are converted to uppercase!

Format	Example
Command {PNAME#<id>=<preset_name>} Response (PNAME#<id>=<preset_name>)CrLf	→ {PNAME#1=first preset} ← (PNAME#1=FIRST PRESET)

7.3.13. Name Inputs

Description: Allows storing names for each input. Any 16- byte long string is allowed.

ATTENTION! All characters are converted to uppercase!

Format	Example
Command {INAME#<id>=<input_name>} Response (INAME#<id>=<input_name>)CrLf	→ {INAME#1=first input} ← (INAME#1=FIRST INPUT)

7.3.14. Name Outputs

Description: Allows storing names for each output. Any 16- byte long string is allowed.

ATTENTION! All characters are converted to uppercase!

Format	Example
Command {ONAME#<id>=<output_name>} Response (ONAME#<id>=<output_name>)CrLf	→ {ONAME#1=first output} ← (ONAME#1=FIRST OUTPUT)

7.3.15. Query Preset Name

Description: Each preset name can be read from the router.

Format	Example
Command {PNAME#<id>=?} Response (PNAME#<id>=<preset_name>)CrLf	→ {PNAME#1=?} ← (PNAME#1=FIRST PRESET)

7.3.16. Query Input Name

Description: Each input name can be read from the router.

Format	Example
Command {INAME#<id>=?} Response (INAME#<id>=<input_name>)CrLf	→ {INAME#1=?} ← (INAME#1=FIRST INPUT)

7.3.17. Query Output Name

Description: Each output name can be read from the router.

Format	Example
Command {ONAME#<id>=?} Response (ONAME#<id>=<output_name>)CrLf	→ {ONAME#1=?} ← (ONAME#1=FIRST OUTPUT)

7.3.18. Reload Default Preset Names

Description: Renames all preset to the default setup Preset 1..32 respectively.

ATTENTION! <id> field has no meaning here, but has to be a valid one!

Format	Example
Command {PNAME#<id>=!} Response (PNAME#<id>=Preset<id>)CrLf	→ {PNAME#1=!} ← (PNAME#1=Preset 1)

7.3.19. Reload Default Input Names

Description: Renames all input to the default setup Input 1..8 respectively.

ATTENTION! <id> field has no meaning here, but has to be a valid one!

Format	Example
Command {INAME#<id>=!} Response (INAME#<id>=Input<id>)CrLf	→ {INAME#1=!} ← (INAME#1=Input 1)

7.3.20. Reload Default Output Names

Description: Renames all output to the default setup Output 1..8 respectively.

ATTENTION! <id> field has no meaning here, but has to be a valid one!

Format	Example
Command {ONAME#<id>=!} Response (ONAME#<id>=Output<id>)CrLf	→ {ONAME#1=!} ← (ONAME#1=Output 1)

7.4. Network Configuration

7.4.1. Query the Current IP Configuration

Description: IP address settings can be queried as follows.

Format	Example
Command {IP_CONFIG=?} Response (IP_CONFIG=<type>• <ip_address>•<ip_port>• <subnet_mask>• <gateway_addr>)CrLf	→ {ip_config=?} ← (IP_CONFIG=7 192.168.0.103 10001 255.255.255.0 192.168.0.1)

Legend:

<type>:	0 = static IP; 7 = DHCP.
<ip_addr>:	IP address.
<ip_port>	IP port
<subnet_mask>:	Subnet mask
<gateway_addr>:	Gateway address

Explanation: The device has DHCP IP address: 192.168.0.103; the port number is 10001; the subnet mask is 255.255.255.0, the gateway address is 192.168.0.1.

For the default TCP/IP parameters see the [Factory Default Settings](#) section.

7.4.2. Reload Factory Default IP Settings

Description: After issuing this command (either over serial or IP) the router will reload the factory default IP setup.

Format	Example
Command {IP_CONFIG=!} Response (Changing IP configuration...) (DONE!)CrLf or (FAILED!)CrLf	→ {IP_CONFIG=!} ← (Changing IP configuration...) (DONE!) or (FAILED!)CrLf

For the default TCP/IP parameters see the section.

7.4.3. Enable DHCP IP Setting

Description: After sending this command the router will inquire IP address with DHCP.

Format	Example
Command {IP_CONFIG=D} Response (Changing IP configuration...) (DONE!)CrLf or (FAILED!)CrLf	→ {IP_CONFIG=D} ← (Changing IP configuration...) (DONE!) or (FAILED!)CrLf

INFO: DHCP setting can be reloaded by the front panel buttons as well (see the [IP Settings](#) section) or via the front panel LCD menu.

7.5. EDID Router Commands

7.5.1. Change EDID on Input

Description: Copy EDID from memory location <loc> to input port <in>.

Format	Example
Command {<in>:<loc>} Response (E_SW_OK)CrLf ...delay... (E_S_C)CrLf	→ {5:10} ← (E_SW_OK) ...delay... ← (E_S_C)

Explanation: EDID #10 is copied to input 5.

INFO: The router sends (E_S_C) only if the new EDID is different from the earlier one.

7.5.2. Change EDID on All Inputs

Description: Copy EDID from memory location <loc> to all inputs.

Format	Example
Command {A:<loc>} Response (E_SW_OK)CrLf ...delay... (E_S_C)CrLf	→ {a:2} ← (E_SW_OK) ...delay... ← (E_S_C)

Explanation: EDID #2 is copied to all inputs.

7.5.3. Save EDID to User Memory

Description: Learn EDID from the specified output <out> to the specified location <loc>.

Format	Example
Command {<out>><loc>} Response (E_SW_OK)CrLf (E_S_C)CrLf	→ {4>3} ← (E_SW_OK) ← (E_S_C)

Explanation: EDID from output 3 is saved to user EDID #4.

7.5.9. Upload EDID Content to the Router

Description: EDID hex bytes can be written directly to the user programmable memory locations. The sequence is the following:

Step 1. Prepare the router to accept EDID bytes to the specified location <loc> with command {WL#<loc>}

Step 2. Router responds that it is ready to accept EDID bytes with (E_L_S)CrLf

Step 3. Send 1 block of EDID (1 block consist of 8 bytes of hex data represented in ASCII format) with command {WB#<num>•<B1>•<B2>•<B3>•<B4> •<B5>•<B6>•<B7>•<B8>}

Step 4. The router acknowledges with response (EL#<num>)

Step 5. Repeat steps 3 and 4 to send the remaining 31 blocks of EDID (32 altogether)

Step 6. After the last acknowledge, the router indicates that the EDID status changed by sending (E_S_C) CrLf

Format		Example	
Command	{WL#<loc>}	→	{wl#3}
Response	(E_L_S)CrLf	←	(E_L_S)
Command	{WB#1•<B1>•<B2>•<B3> •<B4>•<B5>•<B6>•<B7> •<B8>}	→	{WB#1 00 FF FF FF FF FF 00}
Response	(EL#<num>)CrLf	←	(EL#1)
Command	{WB#2•<B9>•<B10>•<B11>•<B12>•<B13> •<B14>•<B15>•<B16>}	→	{WB#2 38 A3 8E 66 01 01 01 01}
Response	(EL#<num>) CrLf	←	(EL#2)

Command	{WB#32•<B249>•<B250> •<B251>•<B252>•<B253> •<B254>•<B255>•<B256>}	→	{WB#32 36 59 42 0A 20 20 00 96}
Response	(EL#<num>) CrLf	←	(EL#32)
Response	(E_S_C) CrLf	←	(E_S_C)

Legend: <num> represents the sequential number of every 8 byte part of EDID. <num> is between 1 and 32. <B1>..<B256> are the bytes of EDID.

Explanation: Full EDID uploaded to memory location 3.

7.6. Port Status Commands

7.6.1. Input Port Status

Description: Shows the actual status of the input ports. The response length changes regarding the frame size.

Format		Example	
Command	{:ISD}	→	{:isd}
Response	(ISD•<INPUT_D>)CrLf	←	(ISD 31000000)

Explanation: The first input board is an HDMI board. Input 1 and 2 have a connected source but no signal. Inputs 3-5 have DVI signals and inputs 6-8 have HDMI signals. The second input board is a DVI board. Input 11 and 12 have DVI signals. The Test Input port has an HDMI signal.

Legend: <INPUT_D> may contain 9, 17, 33 or 80 hexadecimal numbers. Each number represents the state for the corresponding input port. The meaning of the responded number depends on the actual board (port) type. The binary representation of the responded hexadecimal numbers is shown below.

3. bit (MSB)	2. bit	1. bit	0. bit (LSB)
0	HDMI mode	signal detect	source 5V
0	HDMI mode	signal detect	source 5V

- **Source 5V:** The connected source sends 5V.
- **Signal Detect:** Video signal is present (TMDS stream can be recognized).
- **HDMI mode:** The incoming signal is HDMI.

7.6.2. Output Port Status

Description: Shows the actual status of the output ports. The response length changes regarding the frame size. The meaning of the values changes regarding the output board types as the boards have different functions and capabilities.

Format		Example	
Command	{:OSD}	→	{:osd}
Response	(OSD•<OUTPUT_D>)CrLf	←	(OSD 10000000)

Explanation: There are four DVI sinks connected to ports 2, 9, 11 and 12, nothing else.

Legend: <OUTPUT_D> may contain 9, 17, 33 or 80 hexadecimal numbers. Each number represents the state for the corresponding output port. The binary representation of the responded hexadecimal numbers is shown below.

3. bit (MSB)	2. bit	1. bit	0. bit (LSB)
0	0	0	receiver sense
0	0	0	receiver sense

- **Receiver Sense:** TMDS termination present in the connected device.

7.6.3. Get Information about Input Port

Description: You can get more detailed information about an input HDMI port with this command. The response will contain information about the general signal parameters, the video resolution and mode, the audio format, other advanced parameters and the actual settings on this port.

The response repeats the number of the input port after the STI string. There are different blocks present after the equal sign, which are separated by semicolons. Every block contains different type of information and can be recognized about the first character. For example, a block started with 'V' is about the video resolution and format. Some of the blocks might be missing depending on the actual signal – e.g. if the port operates in DVI mode then no audio information will be sent.

	Format	Example
Command	{:HDMIIGET<in>}	→ {:HDMIIGET1}
Response	(STI#<in>=<INFO>;<VIDEO>;<AUDIO>;<ADV_INFO>;<IN_SET>;)CrLf	← (STI1=S1131;V1920x1080p60,675,00;A1C010000;I111190;PAA;)

The exact meanings of different blocks are explained in the following sections.

Legend of <INFO>

The signal info block contains some general information about the signal. The first character of this block must be **S**.

Format: S<a><c><d>

Example: S1131

Identifier	Parameter description	Parameter values
<a>	5V power presence	0 = 5V is not present 1 = 5V is present
	Signal detection	0 = no valid signal on the input 1 = active video signal is present
<c>	DV/HDMI mode indicator	0 = DVI mode 1 = HDMI mode (24 bpp) 2 = HDMI mode (30 bpp), deep color 3 = HDMI mode (36 bpp), deep color
<d>	HDCP state	0 = HDCP encryption is disabled 1 = HDCP encryption is active

5V and active video signal is present in HDMI deep color mode (36 bpp), HDCP is active.

Legend of <VIDEO>

INFO: This block is present only if valid video signal is present on the selected port.

The resolution, refresh rate, scan mode, and color space information are described in this block. The first character of this block must be **V**.

Format: V<Resolution>;<Hsync>;<Color_space>

Example: V800x600p60,378,00

Identifier	Parameter description	Parameter values
<Resolution>	<Width>x<Height><scan><Vsync>	<Width> = active video width (pixels) <Height> = active video height (pixels) <scan> = p : progressive, i : interlaced scan mode <Vsync> value (Hz)
<Hsync>	Horizontal sync	<Hsync> value (kHz)
<Color_space>	Color space information	00 = RGB444 10 = YUV422 20 = YUV444

1080p60 signal is detected with progressive scan at 60 Hz refresh rate; vertical sync value is 675 kHz and the signal is in RGB 4:4:4 color space.

Legend of <AUDIO>

INFO: This block is present only if valid video signal is present on the selected port.

The audio info block determines the type of the audio, the decoded sampling frequency and some further information extracted from Audio InfoFrames. The first character of this block must be **A**.

Format: A<a><c><d><ee><ff>

Example: A1C010000

PCM audio is present at 48 kHz. The codec is not specified, two audio channels are defined.

INFO: Please note that the values of c, d, ee and ff fields are based on the audio info frame sent by the source device while values of a, b are based on measurements. Of course audio info frames are forwarded in unchanged form to the HDMI sink devices (e.g. A/V Receivers) so that they would be able to interpret the InfoFrames correctly.

Identifier	Parameter description	Parameter values		
<a>	Audio type	0 = no audio data is present 2 = Compressed audio 1 = PCM audio 4 = High bitrate audio		
	Sampling frequency	A = 44.1 kHz J = 768 kHz C = 48 kHz K = 96 kHz D = 32 kHz M = 176.4 kHz E = 22.05 kHz O = 192 kHz G = 24 kHz B = no information I = 88.2 kHz		
<c>	Audio codec type (not specified in many cases)	0 = undetermined 7 = DTS 1 = IEC 60958PCM 8 = ATRAC 2 = AC3 9 = One Bit Audio 3 = MPEG-1 (Layers 1&2) A = Dolby Digital 4 = MP3 (MPEG-1 Layer 3) B = DTS-HD 5 = MPEG-2 (multichannel) C = MLP 6 = AAC		
<d>	Audio channel number	0 = not specified 0..7 = channel number is equal to (<d>+1)		
<ee>	Sampling frequency and sample size (encoded in HEX format and represented by binary format)	7-5 bits: reserved and shall be 0 (zero)	4-2 bits: 000 = unspecified 001 = 32 kHz 010 = 44.1 kHz 011 = 48 kHz 100 = 88.2 kHz 101 = 96 kHz 110 = 176.4 kHz 111 = 192 kHz	1-0 bits: 00 = not specified 01 = 16 bit 10 = 20 bit 11 = 24 bit
		example: 0F = 000 011 11 48 kHz sampling frequency and 24 bit sample length		
<ff>	Speaker locations	This byte describes how various speaker locations are allocated to the audio channels: FR/FL = Front Right / Front Left LFE = Low-frequency effect FC/RC = Front Center / Rear Center RR/RL = Rear Right / Rear Left FRC/FLC = Front Right Center / Front Left Center RRC/RLC = Rear Right Center / Rear Left Center See the following table for the possible values.		

<ff> value	Channel number							
	8	7	6	5	4	3	2	1
00							FR	FL
01						LFE	FR	FL
02					FC		FR	FL
03					FC	LFE	FR	FL
04				RC			FR	FL
05				RC		LFE	FR	FL
06				RC	FC		FR	FL
07				RC	FC	LFE	FR	FL
08			RR	RL			FR	FL
09			RR	RL		LFE	FR	FL
0A			RR	RL	FC		FR	FL
0B			RR	RL	FC	LFE	FR	FL
0C		RC	RR	RL			FR	FL
0D		RC	RR	RL		LFE	FR	FL
0E		RC	RR	RL	FC		FR	FL
0F		RC	RR	RL	FC	LFE	FR	FL
10	RRC	RLC	RR	RL			FR	FL
11	RRC	RLC	RR	RL		LFE	FR	FL
12	RRC	RLC	RR	RL	FC		FR	FL
13	RRC	RLC	RR	RL	FC	LFE	FR	FL
14	FRC	FLC					FR	FL
15	FRC	FLC				LFE	FR	FL
16	FRC	FLC			FC		FR	FL
17	FRC	FLC			FC	LFE	FR	FL
18	FRC	FLC		RC			FR	FL
19	FRC	FLC		RC		LFE	FR	FL
1A	FRC	FLC		RC	FC		FR	FL
1B	FRC	FLC		RC	FC	LFE	FR	FL
1C	FRC	FLC	RR	RL			FR	FL
1D	FRC	FLC	RR	RL		LFE	FR	FL
1E	FRC	FLC	RR	RL	FC		FR	FL
1F	FRC	FLC	RR	RL	FC	LFE	FR	FL

Legend of <ADV_INFO>

For advanced users this block provides information which could be useful during debugging process. The first character of this block must be **I**.

Format: I<a><c><d><e><f>

Example: I1111190

Identifier	Parameter description	Parameter values
<a>	VSYNC polarity	0 = VSYNC polarity is negative (leading edge falls) 1 = VSYNC polarity is positive (leading edge rises)
	HSYNC polarity	0 = HSYNC polarity is negative (leading edge falls) 1 = HSYNC polarity is positive (leading edge rises)
<c>	TMDS clock line signal presence	0 = There is no change on the TMDS clock line 1 = Signal is present on the TMDS clock line
<d>	TMDS clock line stability	0 = The clock signal is unstable on the TMDS clock line 1 = The clock signal is stable on the TMDS clock line
<e>	Active Format Aspect Ratio based on AVI InfoFrame	0 = Field is not present (e.g. DVI signal) 2 = 16:9 (top) 3 = 14:9 (top) 4 = greater than 16:9 (centre) 5 = Same as picture aspect ratio 9 = 4:3 (centre) A = 16:9 (centre) B = 14:9 (centre) D = 4:3 (with shoot and protect 14:9 centre) E = 16:9 (with shoot and protect 14:9 centre) F = 16:9 (with shoot and protect 4:3 centre)
<f>	Pixel repetition factor based on AVI InfoFrame	0 = No repetition (i.e. pixel sent once) 1 = Pixel sent 2 times (i.e. repeated once) 3 = Pixel sent 4 times

Positive HSYNC and VSYNC, stable pixel clock, 4:3 aspect ratio and no pixel repetition).

Legend of <IN_SET>

You are able to verify the actual settings on the selected input ports with this block. This block is always present. The first character is **P**.

Format: P<a>

Example: PAA

Identifier	Parameter description	Parameter values
<a>	Cable equalization level	0 = Automatic cable equalization 1 = Equalization is 3dB 2 = Equalization is 9dB 3 = Equalization is 25dB 4 = Equalization is 35dB 5 = Equalization is 40dB
	State of color range compression	The values are the same as described at Color range conversion settings section, see the Color Range Conversion Settings section.

Automatic cable equalization and color range conversion is disabled.

7.6.4. Get Information about the Output Port

Description: This command gets more detailed information about an output HDMI port. The response will contain information about the general signal parameters, the video resolution and mode, the audio format, other advanced parameters, the capabilities of the sink device and the actual settings of this port.

The main structure is the same as described at the HDMIGET command in the [Get Information about Input Port](#) section. The STO response may have <VIDEO> block, <AUDIO> block and <ADV_INF> block with the same syntax as described previously but there are also several new block types.

	Format	Example
Command	{:HDMIOUT<out>}	→ {:HDMIOUT1}
Response	(STO#<out>=<INFO>;<VIDEO>;<AUDIO>;<ADV_INFO>;<SINK_INFO>;<OUT_SET>;)CrLf	← (STO1=G10101;V800x600p60,379,00;I111100;M110111077;OAAAAAU;)

The exact meanings of the new blocks are explained in the following sections.

Legend of <INFO>

This block provides information about the general status of the selected HDMI output port. The first character is **G**.

Format: G<a><c><d><e>

Example: G10101

Identifier	Parameter description	Parameter values
<a>	Sink connection	0 = there is no attached sink device 1 = attached sink device is present (termination is present)
	Signal mode indicator	0 = DVI mode 1 = HDMI mode (24 bpp) 2 = HDMI mode (30 bpp), deep color 3 = HDMI mode (36 bpp), deep color
<c>	Signal validity	0 = No valid signal is routed to this port 1 = Valid video signal is present
<d>	HDCP state	0 = HDCP encryption is disabled 1 = HDCP encryption is active
<e>	Hotplug presence	0 = Hotplug detect signal is low 1 = Hotplug detect signal is high

Sink is present, DVI mode is active, valid video signal is present, HDCP encryption is disabled, hotplug signal is high.

Legend of <SINK_INFO>

This block provides some general information about the attached sink device based on the EDID and the HDCP cypher engine. Please note that you are able to get much more detailed information by downloading the full EDID structure with the „we” command. The first character of this block is **M**.

Format: M<a><c><d><e><f><gg><h>

Example: M110111077

Identifier	Parameter description	Parameter values
<a>	HDMI compatibility	0 = Sink device doesn't support HDMI 1 = Sink device is HDMI-compatible
	HDCP authentication	0 = HDCP authentication failed 1 = HDCP authentication is successful
<c>	HDCP repeater	0 = Sink device is not a HDCP repeater 1 = Sink device is a HDCP repeater
<d>	YUV444 supportation	0 = Sink device doesn't support YUV444 color space 1 = Sink device supports YUV444 color space
<e>	YUV422 supportation	0 = Sink device doesn't support YUV422 color space 1 = Sink device supports YUV422 color space
<f>	Audio capabilities	0 = Sink device has no audio capabilities 1 = Sink device has audio capabilities
<gg>	This field represents a byte in hexadecimal format.	data bit 0 - Sink device supports 32kHz PCM audio data bit 1 - Sink device supports 44kHz PCM audio data bit 2 - Sink device supports 48kHz PCM audio data bit 3 - Sink device supports 88kHz PCM audio data bit 4 - Sink device supports 96kHz PCM audio data bit 5 - Sink device supports 176kHz PCM audio data bit 6 - Sink device supports 192kHz PCM audio data bit 7 - Reserved (Always 0 in this version of protocol)
<h>	One digit number	data bit 2 - HDMI deep color 30bits/pixel mode is supported data bit 1 - HDMI deep color 36bits/pixel mode is supported data bit 0 - YUV444 color space is supported in DC modes

HDMI and HDCP capable device, not HDCP repeater, it supports all color spaces and 32kHz, 44kHz and 48kHz PCM audio. All deep color modes are supported. Additional audio formats may be stored in the EDID.

INFO: Field <c> value is accurate only if the field is equal to 1.

Legend of <OUT_SET>

This block contains information about the actual settings of the selected HDMI output port. The first character of the block is **O**.

Format: O<a><c><d><e><f>

Example: OAAAAAU

Identifier	Parameter description	Parameter values
<a>	HDMI mode	A = The HDMI/DVI mode selection is automatic. D = Always send DVI signal H = Force 24bits/pixel HDMI signal 1 = Force 30bits/pixel HDMI deep color signal 2 = Force 36bits/pixel HDMI deep color signal x = Don't modify this setting
	Color space	A = Automatic color space selection 1 = Force RGB 2 = Force YUV444 3 = Force YUV422 x = Don't modify this setting
<c>	Color range	A = Handle color range conversion automatically C = Compress the incoming color range to 16-235 E = Expand the incoming color range to full scale x = Don't modify this setting
<d>	PCM subsampling	A = Automatic PCM subsampling D = Disable PCM subsampling 2 = 2x PCM subsampling (it only affects 2ch PCM signals!) 4 = 4x PCM subsampling (it only affects 2ch PCM signals!) x = Don't modify this setting
<e>	HDCP handling	A = Handle HDCP automatically 1 = Always use HDCP x = Don't modify this setting
<f>	Reserved for future use.	

The HDMI/DVI mode, the color space selection, the color range conversion, the PCM subsampling, and the HDCP handling are set to automatic.

7.6.5. Set HDMI Output Port Parameters

Description: HDMI output cards have various settings, which can be set with this command. Every setting has an automatic mode (this is the default) when the system selects the proper conversions based on the type of the video signal and the capabilities of the sink device, but you are also able to force other conversions with this command.

If you send the first version of the command (with @SO) then the new settings will affect only the <out> output port. The @AO version will affect all HDMI output ports regardless of the value of the <out> field.

Format		Example
Command	{:HDMISET#<out>@SO=<a>;;<c>;<d>;<e>;}	→ {:HDMISET#1@SO=H;2;x;x;x;}
Response	(STO#<out>=<INFO>;<VIDEO>;<AUDIO>;<ADV_INFO>;<SINK_INFO>;<OUT_SET>;)CrLf	← (STO1=G1100;OH2AAA;)

The meanings of the <a>, , <c>, <d>, and <e> fields are the same as the parameters of <OUT_SET> legend described in the [Get Information about the Output Port](#) section.

7.6.6. Color Range Conversion Settings

Description: You are able to control the color range conversion with this command on the input ports. There are three options: leave the color range unchanged, compress or expand.

The first version of the command (@SI) will affect only one port while the second (@AI) makes changes on all inputs. However the <in> field has no significance in that case, it must be valid.

Format		Example
Command	{:HDMISET#<in>@SI=<a>}	→ {:HDMISET#1@SI=A}
Response	(STI#<in>@<S/A>I=<INFO>;<VIDEO>;<AUDIO>;<ADV_INFO>;<IN_SET>;)CrLf	← (STI1=S1100;V800x600p60,379,00;I111100;P2A1;)

The possible values of the field <a> are:

Value	Meaning
A	No color range conversion
C	Compress the color range (0-255 > 16-235)
E	Expand the color range (16-235 > 0-255)

After the successful execution the system is going to respond with an STI response with an included Input settings info block – so you are able to verify the new settings.

7.6.7. Measure Timing Parameters

Description: The system continuously measures the parameters of the incoming signals such as pixel clock frequency, horizontal and vertical back porch, front porch etc. You are able to read this information from the matrix with this command. This could be useful only for advanced debugging processes. To get the active video resolution and common video parameters please use the HDMIIGET command as explained in the [Get Information about Input Port](#) section.

This section assumes that you are familiar with the DVI standard and the computer science.

The `{:TIMINGS<in>}` command will request the detailed timings information on the input port `<in>`. The port number shall not be padded with zeros.

The answer repeats the command and consists of 15 data bytes. Every data byte is represented as a two-digit hexadecimal number.

	Format	Example
Command	<code>{:TIMINGS<in>}</code>	→ <code>{:TIMINGS8}</code>
Response	<code>(:TIMINGS<in>=[hexadecimal data bytes])CrLf</code>	← <code>(:TIMINGS8=087004e2064004b031010100c00165)</code>

The meanings of these data bytes are:

Data bytes	Description
1	Measured interval between two HSYNC active edges. The unit of the value is unique pixels. MSB byte is first.
2	
3	Measured interval between two VSYNC active edges. The unit of the value is lines. MSB byte is first.
4	
5	Defines the width of the active display area. The unit of the value is unique pixels. MSB byte is first.
6	
7	Defines the height of the active display area. The unit of the value is unique pixels. MSB byte is first.
8	
9	VSYNC to active video lines. This is equal to vertical sync width plus vertical back porch. The unit of the value is lines.
10	Vertical sync front porch time measured in lines.
11	Reserved for future use
12	Width of the HSYNC pulse in units of unique pixels. LSB byte is first.
13	
14	V value. This number is used to determine the actual pixel clock frequency. MSB byte is first.
15	

Use the following formula to calculate the actual pixel clock frequency:

$$f_{\text{pixelclock}} = 58003,46 / V$$

INFO: Pixel clock is not equal to TMDS clock in deep color modes. To calculate the TMDS clock you have to determine the number of bits per pixel (bpp) by running an HDMIIGET command. The TMDS clock is equal to pixel clock multiplied by $\text{bpp}/24$. If you want to evaluate the data rate or the needed bandwidth, you have to calculate with TMDS clock.

7.7. Programmers' Reference – Quick Summary

General Commands

Operation	See in section	Command
View Product Type	7.2.1	{i}
Front panel controls in TAKE mode	7.2.2	{F}
View Serial Number	7.2.3	{S}
Compile Time	7.2.4	{CT}
View Installed Boards	7.2.5	{IS}
View Firmware for All Controllers	7.2.6	{FC}
Restart the Device	7.2.7	{RST}
Query Health Status	7.2.8	{ST}
View Current Communication Protocol	7.2.9	{P_?}
Set Communication Protocol	7.2.10	{P_<x>}
Count HDCP Keys	7.2.11	{:HDCPTEST<in>@<num>}
Clear HDCP Key Cache	7.2.12	{:HDCPRESET}

Port Settings

Operation	See in section	Command
Switch One Input to One Output	7.3.1	{<in>@<out>}
Switch One Input to All Outputs	7.3.2	{<in>@0}
Mute Specified Output	7.3.3	{#<out>}
Unmute Specified Output	7.3.4	{+<out>}
Lock the Output	7.3.5	{#><out>}
Unlock the Output	7.3.6	{+<out>}
View Connection State	7.3.7	{VC}
View Mutes on All Outputs	7.3.8	{VM}
Save Preset	7.3.9	{\$<id>}
Load Preset	7.3.10	{%<id>}
View Preset Without Loading	7.3.11	{VP#<id>=?}
Name Presets	7.3.12	{PNAME#<id>=<preset_name>}
Name Inputs	7.3.13	{INAME#<id>=<input_name>}
Name Outputs	7.3.14	{ONAME#<id>=<output_name>}

Operation	See in section	Command
Query Preset Name	7.3.15	{PNAME#<id>=?}
Query Input Name	7.3.16	{INAME#<id>=?}
Query Output Name	7.3.17	{ONAME#<id>=?}
Reload Default Preset Names	7.3.18	{PNAME#<id>=!}
Reload Default Input Names	7.3.19	{INAME#<id>=!}
Reload Default Output Names	7.3.20	{ONAME#<id>=!}

Network Configuration

Operation	See in section	Command
Query the Current IP Configuration	7.4.1	{IP_CONFIG=?}
Reload Factory Default IP Settings	7.4.2	{IP_CONFIG=!}
Enable DHCP IP Setting	7.4.3	{IP_CONFIG=D}

EDID Router Settings

Operation	See in section	Command
Change EDID on Input	7.5.1	{<loc1>:<loc2>}
Change EDID on All Inputs	7.5.2	{EA:<loc2>}
Save EDID to User Memory	7.5.3	{<loc1>:<loc2>}
View Emulated EDIDs on All Inputs	7.5.4	{VEDID}
Watch EDID Validity Table	7.5.5	{WV<type>}
View EDID Header	7.5.6	{WH<loc>}
Delete EDID from Memory	7.5.7	{DE<loc>}
Download EDID Content	7.5.8	{WE#<loc>}
Upload EDID Content to the Router	7.5.9	{WL#<loc>}

Port Status Commands

Operation	See in section	Command
Input Port Status	7.6.1	{:ISD}
Output Port Status	7.6.2	{:OSD}
Get Information about Input Port	7.6.3	{:HDMIIGET<in>}
Get Information about the Output Port	7.6.4	{:HDMIOGET<out>}
Color Range Conversion Settings	7.6.5	{:HDMISSET#<out>@SO=<a>;;<c>;<d>;<e>;}
Color Range Conversion Settings	7.6.6	{:HDMISSET#<in>@SI=<a>}
Measure Timing Parameters	7.6.7	{:TIMINGS<in>}

8

Firmware Upgrade

This chapter is meant to help customers perform firmware upgrades on our products by giving a few tips on how to start and by explaining the features of the Bootloader software. To get the latest software and firmware pack please contact support@lightware.com.

WARNING! All EDIDs in the User Memory will be lost after the firmware upgrade. Save the user EDIDs before processing the upgrade.

8.1. Short Instructions

- Step 1.** Get the **Lightware Bootloader** Software and the firmware files.
- Step 2.** Install the application and prepare the firmware files.
- Step 3.** Connect the computer to the matrix via LAN and launch the Bootloader.
- Step 4.** Find the device and establish the connection.
- Step 5.** Select the desired controllers.
- Step 6.** Perform the firmware upgrade.
- Step 7.** Finish and restart the matrix.

8.2. Detailed Instructions

Step 1: Get the Lightware Bootloader Software and the Firmware Files

Use the Lightware Bootloader application to upgrade the firmware(s) of the matrix. Please contact support@lightware.com to get the latest application and the firmware files.

Step 2: Install the Application and Prepare the Firmware Files

Run the Bootloader installer; installing the application to the default destination is recommended. If you got the firmware files, extract them to a folder on the computer.

Step 3: Connect the Computer to the Matrix via LAN and Launch the Bootloader

TIPS AND TRICKS: To avoid packet loss caused by an overloaded network, it is recommended to use the supplied cross UTP cable directly from the upgrading PC to the matrix.

If the computer is connected via a network hub, switch, or router, you can set the matrix to have a static IP address or a dynamic IP address.

- **Static IP address:** in this case, make sure there is no IP conflict on the network.
- **Dynamic IP address:** in this case, the matrix has got an IP address automatically if a DHCP server is in the network.

TIPS AND TRICKS: If you do not know the IP address of the matrix, close the bootloader and launch the Lightware Device Controller software. The desired device and its IP address must be listed in the Device Discovery window if a proper connection has been established.

The static/dynamic IP settings can be done by the front panel buttons, please see the [IP Settings](#) section.

Run the **Lightware Bootloader** software.

Step 4: Find the Device and Establish the Connection

Make sure that no other active connection is established to the matrix (running the Lightware Device Controller software or a web browser and the built-in website). Please wait until all the devices on the network completely start up, then click on the **Find** button to query the Ethernet; the discovered devices are listed.

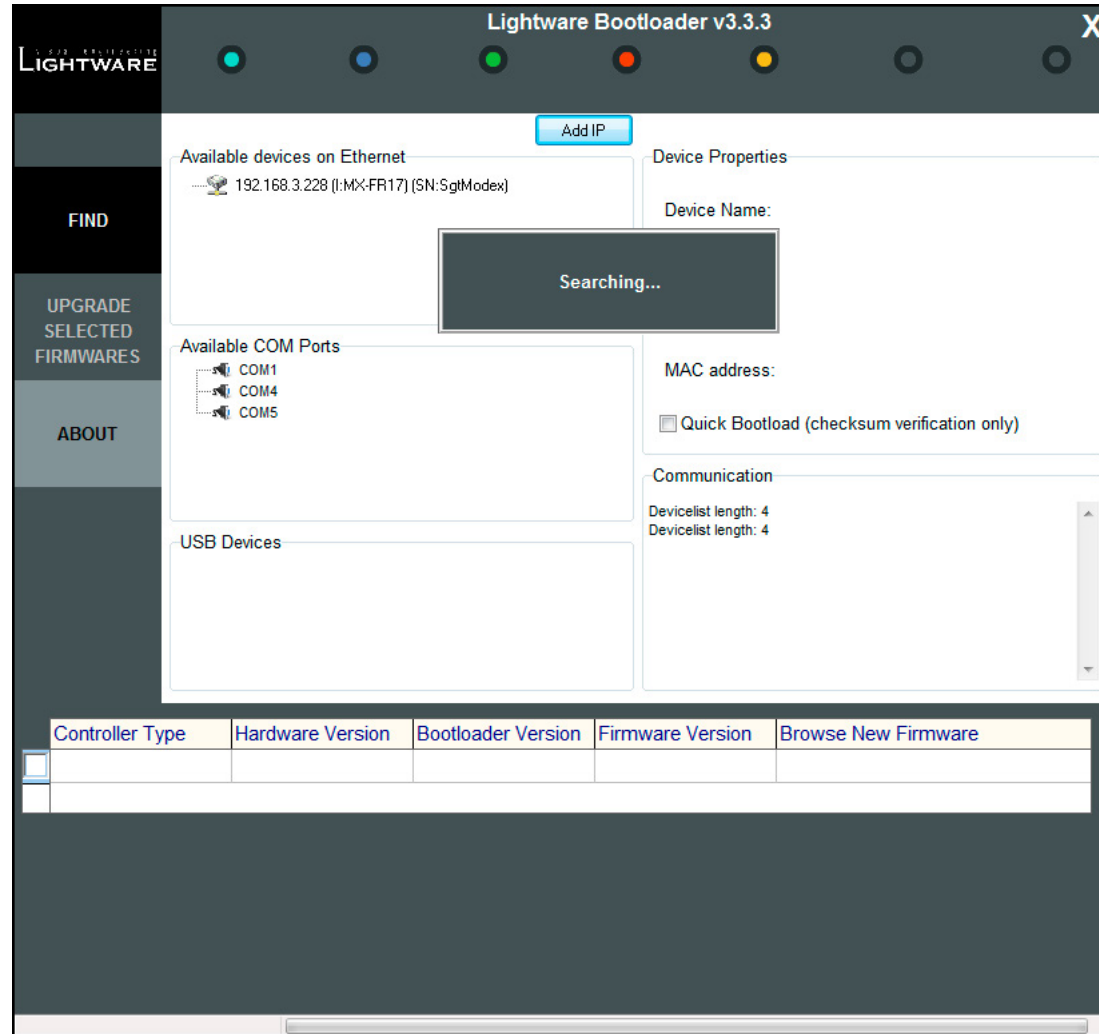

Lightware Bootloader – Searching for Devices

If the desired device is not discovered for some reason but you know its IP address you can add it manually. Press the **Add IP** button and fill the text boxes. Double click on the **IP address**, then click **Yes** to establish the connection. It will take 10-15 seconds to load all the information.

IP Address:

Use the following TCP Port:

Port:

ATTENTION! The bootloader application will restart the matrix when it establishes the connection. All connected DVI sources and monitors will act as if the matrix was powered down. The matrix beeps when it is rebooted.

Step 5: Select the Desired Controllers

After the connection is made, the device properties and the installed controller modules are displayed.

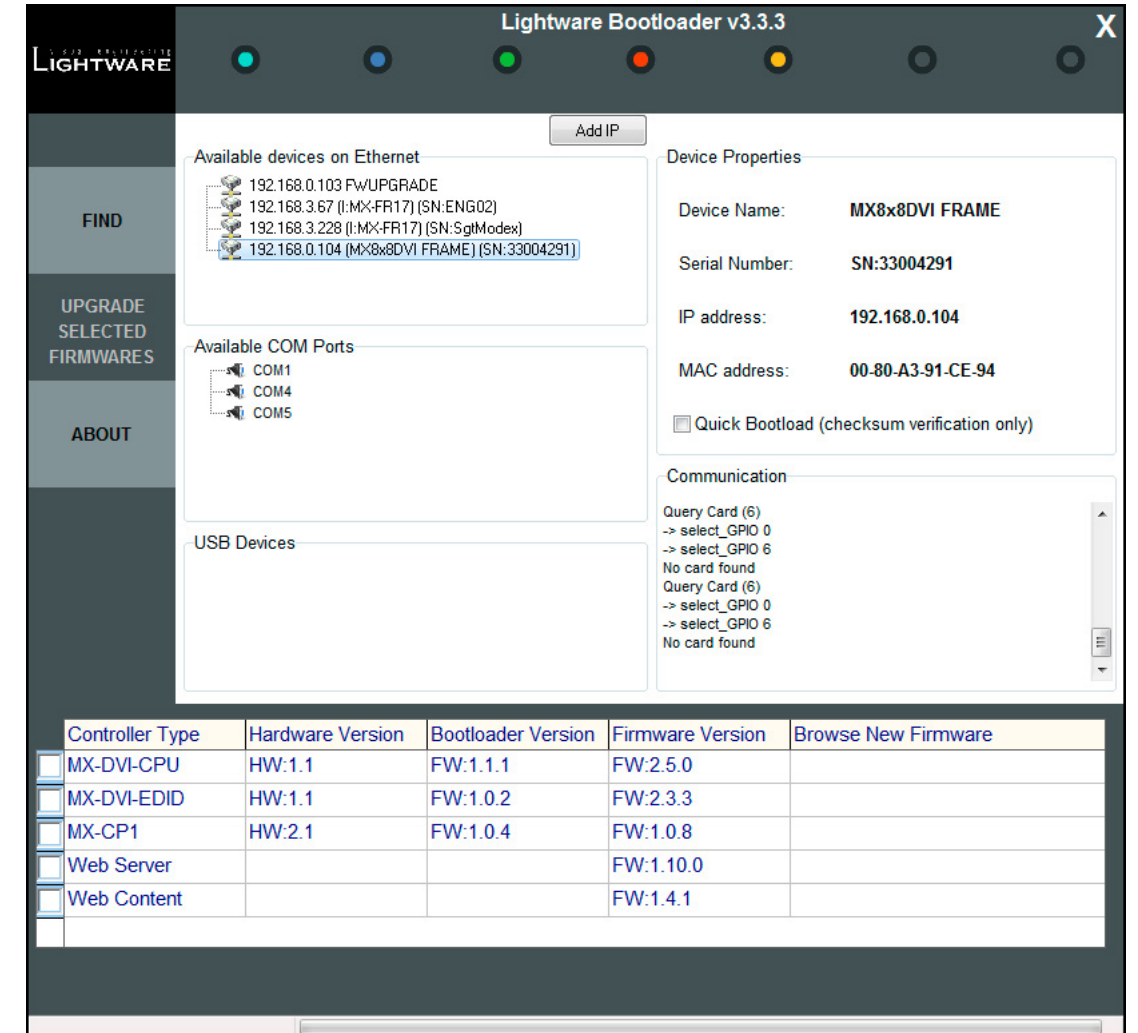

Lightware Bootloader – Details of the Device

Select the desired controllers by clicking the checkboxes.

Controller Type	Hardware Version	Bootloader Version	Firmware Version	Browse New Firmware
<input type="checkbox"/> MX-DVI-CPU	HW:1.1	FW:1.1.1	FW:2.5.0	
<input checked="" type="checkbox"/> MX-DVI-EDID	HW:2.5	FW:1.0.2	FW:3.3.4	MX-CPU1_EDID_SLIM_v3.3.4.hex
<input type="checkbox"/> MX-CP1	HW:2.1	FW:1.0.4	FW:1.0.8	
<input checked="" type="checkbox"/> Web Server			FW:1.10.0	WEBSERVER_MX-CPU1_v1.1.6.ro
<input type="checkbox"/> Web Content			FW:1.4.1	

Load the new firmware files for each controller; click on the cell in the Browse New Firmware column of the desired controller (see the pointer on above picture). A dialog pops up to confirm if you really want to load a new firmware (modify the path). Now you can browse the new firmware file. After opening the new file, the cell will contain the name of the firmware file.

Step 6: Perform the Firmware Upgrade

Press the **Upgrade selected firmwares** button; a confirmation message appears. After clicking the **Yes** button the selected controllers are being reprogrammed by the firmware you selected. If you selected a file that does not belong to the given controller you will get a message. If you selected a controller to upgrade but you had not set a firmware file to it then you will also get a message.

Quick Bootload mode can be switched on or off at any time. It makes the bootloader software faster by only checking the checksum of the controller. No data verification is done after writing if the checksum was correct.

ATTENTION! The reprogramming can take between 3-8 minutes per controller.

A progress bar will show the current state of the reprogramming on the bottom of the main window. In certain cases, the firmware of the given controller is erased which is also shown by the progress bar, thus, the progress bar runs up twice.



Step 7: Finish and Restart the Matrix

When the reprogramming is finished, a message will appear in the bottom left corner (**Done!**). If the upgrade was successful, the following window pops up.

The device is disconnected from the application automatically and the matrix is restarted. Now you can close the application, or you can select another matrix router to upgrade. After closing the bootloader application, switch the upgraded devices off and then on. Now the matrix is ready to be used with the new firmware.

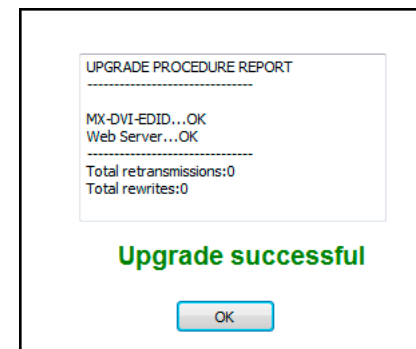





















9

Troubleshooting

Usually, if the system seems not to transport the signal as expected, the best strategy for troubleshooting is to check signal integrity through the whole signal chain starting from source side and moving forward to receiver end. At first, check front panel LEDs and take the necessary steps according to their states. For more information about status, LEDs refer to the [Front View](#) section.

Pictogram Legend

-  Link to the section of connections/cabling.
-  Link to the section of front panel operation.
-  Link to the section of the LDC.
-  Link to the section of LW3 protocol commands.

Symptom	Root cause	Action	Refer to
Video signal			
No picture on the video output	Device or devices are not powered properly	Check the extenders and the other devices if they are properly powered; try to unplug and reconnect them.	
	Cable connection problem	Cables must fit very well, check all the connectors (video cables).	
	The output is muted	Check the mute state of output ports.	 6.4.1.2  7.3.8
	Display is not able to receive the video format	Check the emulated EDID; select another (e.g. emulate the display's EDID on the input port).	 6.6.1  7.5.4
	HDCP is disabled	Enable HDCP on the input port.	 6.5.4
Audio signal			
No audio is present on output	Output port is muted	Check the output port properties.	 6.4.1.2
HDMI output signal contains no audio	HDMI mode was set to DVI	Check the properties of the output port and set to HDMI or Auto.	 6.4.1.2
	DVI EDID is emulated	Check the EDID and select and HDMI EDID to emulate.	 6.6.1  7.5.4
Serial connection			
Cannot connect to the matrix via RS-232	RS-232 settings are different	Check the port settings of the connected computer. Set the default settings of the matrix.	11.2
Ethernet connection			
No LAN connection can be established	Incorrect IP address is set (fix IP)	Use dynamic IP address by enabling DHCP option.	 4.2.7  6.7.1  7.4.3
		Restore the factory default settings (with fix IP).	 4.3.2  6.7.1  7.4.2
	IP address conflict	Check the IP address of the other devices, too.	

10

Technologies

The following sections contain descriptions and useful technical information on the devices work in the background. The content is based on experiences and cases we met in practice. These sections help to understand features and technical standards like the followings:

- ▶ [SHORT INSTRUCTIONS](#)
- ▶ [DETAILED INSTRUCTIONS](#)
- ▶ [EDID MANAGEMENT](#)
- ▶ [HDCP MANAGEMENT](#)
- ▶ [PIXEL ACCURATE RECLOCKING](#)

10.1. EDID Management

10.1.1. Understanding the EDID

The Extended Display Identification Data (EDID) is the passport of display devices (monitors, TV sets, projectors). It contains information about the capabilities of the display, such as supported resolutions, refresh rates (these are called Detailed Timings), the type and manufacturer of the display device, etc.

After connecting a source to a display (DVI, HDMI, DP), the source reads out the EDID to determine the resolution and refresh rate of the image to be transmitted.

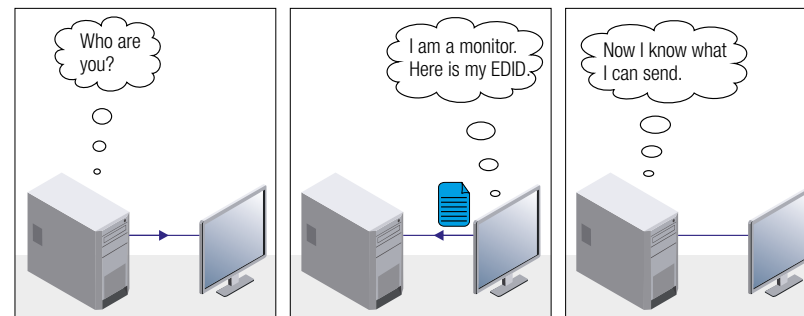

EDID Communication

Most DVI computer displays have 128-byte long EDID structure. However, Digital Televisions and HDMI capable displays may have another 128 bytes, which is called E-EDID and defined by CEA (Consumer Electronics Association). This extension contains information about additional Detailed Timings, audio capabilities, speaker allocation and HDMI capabilities. It is important to know that all HDMI capable devices must have CEA extension, but not all devices with CEA extension are HDMI capable.

Common Problems Related to EDID

Problem: “My system consists of the following: a computer, a Lightware device, a WUXGA (1920x1200) LCD monitor, and an SXGA (1280x1024) projector. I would like to see the same image on the monitor and the projector. What EDID should I choose on the Lightware device?”

Solution: If you want to see the image on both displays, you need to select the resolution of the smaller display (in this case SXGA), otherwise the smaller display may not show the higher resolution image.

Problem: “I have changed to a different EDID on an input port of the Lightware device to have a different resolution but nothing happens.”

Solution: Some graphics cards and video sources read out the EDID only after power-up and later they do not sense that EDID has been changed. You need to restart your source to make it read out the EDID again.

10.1.2. Advanced EDID Management

Each DVI sink (e.g. monitors, projectors, plasma displays, etc...) must support the EDID data structure. Source BIOS and operating systems are likely to query the sink using DDC2B protocol to determine what pixel formats and interface are supported. DVI standard uses EDID data structure to identify the monitor type and capabilities. Most DVI sources (VGA cards, set top boxes, etc.) will output DVI signal after accepting the connected sink's EDID information. In the case of EDID readout failure or missing EDID, the source will not output DVI video signal.

Lightware devices provide the Advanced EDID Management function that helps system integration. The built-in EDID Router can store and emulate factory pre-programmed- and User programmable EDIDs. The EDID of the attached monitors or projectors for each output are stored in a non-volatile memory. This way the EDID of a monitor is available when the monitor is unplugged or switched off.

Any EDID can be emulated on any input. An emulated EDID can be copied from the EDID router's memory (static EDID emulation), or from the last attached monitor's memory (dynamic EDID emulation). For example, the Lightware device can be set up to emulate a sink device, which is connected to one of the outputs. In this case, the EDID automatically changes, if the monitor is replaced with another display device (as long as it has a valid EDID).

EDID is independently programmable for all inputs without affecting each other. All inputs have their own EDID circuit.

INFO: The user is not required to disconnect the video cable to change an EDID as opposed to other manufacturer's products. EDID can be changed even if a source is connected to the input and powered ON.

INFO: When EDID has been changed, the router toggles the HOTPLUG signal for 2 seconds. Some sources do not sense this signal. In such cases, the source device must be restarted or powered OFF and ON again.

10.2. HDCP Management

Lightware Visual Engineering is a legal HDCP adopter. Several functions have been developed which helps to solve HDCP related problems. Complex AV systems often have both HDCP and non-HDCP components. The matrix allows transmitting HDCP encrypted and unencrypted signals. The devices will be still HDCP compliant as they will never output an encrypted signal to a non-HDCP compliant display device. If an encrypted signal is switched to a non-compliant output, a red screen alert or muted screen will appear.

10.2.1. Protected and Unprotected Content

Many video sources send HDCP protected signal if they detect that the sink is HDCP capable – even if the content is not copyrighted. This can cause trouble if an HDCP capable device is connected between the source and the display. In this case, the content cannot be viewed on non-HDCP capable displays and interfaces like event controllers. Rental and staging technicians often complain about certain laptops, which are always sending HDCP encrypted signals if the receiver device (display, matrix router, etc.) reports HDCP compliancy. However, HDCP encryption is not required all the time e.g. computer desktop image, certain laptops still do that.

To avoid unnecessary HDCP encryption, Lightware introduced the HDCP enabling/disabling function: the HDCP capability can be disabled in the Lightware device. If HDCP is disabled, the connected source will detect that the sink is not HDCP capable, and turn off authentication.

10.2.2. Disable Unnecessary Encryption

HDCP Compliant Sink



All the devices are HDCP-compliant, no manual setting is required, both protected and unprotected contents are transmitted and displayed on the sink.

Not HDCP-compliant Sink 1.

Not-HDCP compliant sink is connected to the matrix. Some sources (e.g. computers) always send HDCP encrypted signals if the receiver device reports HDCP compliancy, however, HDCP encryption is

not required all the time (e.g. computer desktop image). If HDCP is enabled in the matrix, the image will not be displayed on the sink.



Setting the HDCP parameter to Auto on the output port and disable HDCP on the input port, the transmitted signal will not be encrypted if the content is not protected. Thus, non-HDCP compliant sinks will display non-encrypted signal.

Not HDCP-compliant Sink 2.



The layout is the same as in the previous case: non-HDCP compliant display device is connected to the matrix but the source would send protected content with encryption. If HDCP is enabled on the input port of the matrix, the source will send encrypted signal. The sink is not HDCP compliant, thus, it will not display the video signal (but blank/red/muted/etc. screen). If HDCP is disabled on the input port of the matrix, the source will not send the signal. The solution is to replace the display device to an HDCP-capable one.

10.3. Pixel Accurate Reclocking

Signal reclocking is an essential important procedure in digital signal transmission. After passing the reclocking circuit, the signal becomes stable, jitter-free, and can be transmitted over more equipment like processors, or event controllers. Without reclocking, sparkles, noise, and jaggies appear on the image.

Lightware's sophisticated Pixel Accurate Reclocking technology fixes more problems than general TMDs reclocking. It removes not only intra-pair skew but inter-pair skew as well. The Pixel Accurate Reclocking circuit eliminates the following errors.

Intra-pair skew

Skew between the + and - wires within a differential wire pair (e.g. Data2- and Data2+). It's caused by different wire lengths or slightly

different wire construction (impedance mismatch) in DVI cable. It results in jitter.

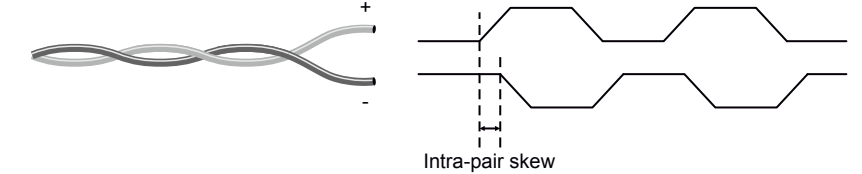

Inter-pair skew

Skew between two differential wire pairs in a cable. It is caused by different wire pair lengths or different number of twists in the DVI cable. Too much inter-pair skew results color shift in the picture or sync loss.

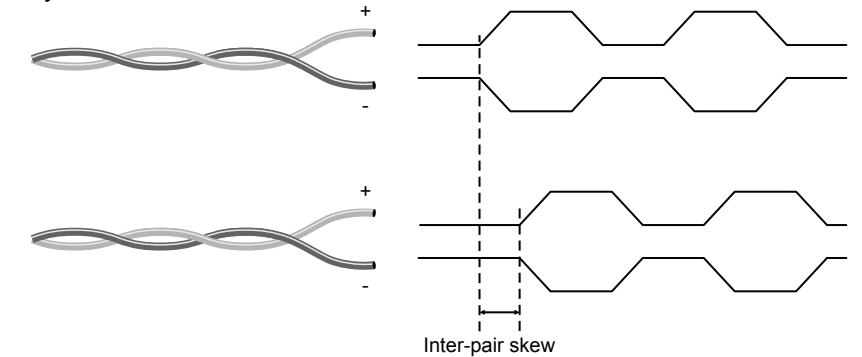

Jitter

Signal instability in the time domain. The time difference between two signal transitions should be a fixed value, but noise and other effects cause variations.

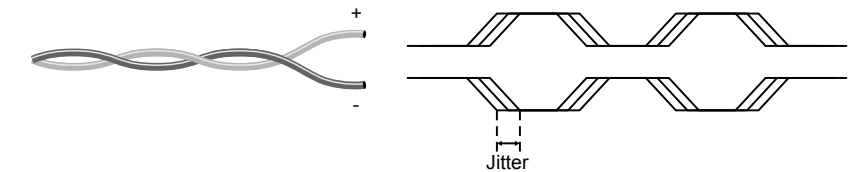

Noise

Electromagnetic interference between other electronic devices such as mobile phones, motors, etc. and the DVI cable are coupled onto the signal. Too much noise results in increased jitter.

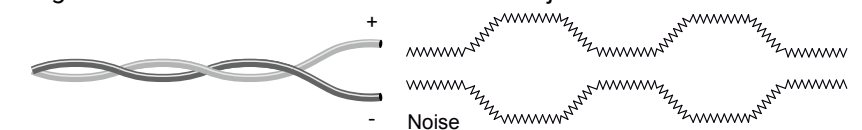

11

Appendix

- ▶ [SPECIFICATION](#)
- ▶ [FACTORY DEFAULTS SETTINGS](#)
- ▶ [FACTORY EDID LIST](#)
- ▶ [MECHANICAL DRAWINGS](#)
- ▶ [FURTHER INFORMATION](#)

11.1. Specifications

General

Compliance	CE
EMC compliance (emission)	EN 55032:2015
EMC compliance (immunity)	EN 55024:2011
Warranty	3 years
Cooling	Fan, air flows right to left (as viewed from front)
Operating temperature	0 to +55°C (+32 to +122°F)
Operating humidity	10% to 90%, non-condensing

Power

Heat dissipation	120 BTU/h (max.), 85 BTU/h (typ)
Power source	In 100-240 V AC, 50/60 Hz
Power consumption	72.6 W (typ), 94.3 W (max)

Enclosure

Rack mountable	Yes
Material	1 mm steel
Dimensions in mm	446 (482*) W x 418.8 D x 43.9 H
Dimensions in inch	17.5 (18.9*) W x 16.2 D x 1.7 H
Weight	6250 g

* without rack ears

Audio/Video ports

HDMI port

HDMI port connector type	19-pole HDMI Type A receptacle
Standard	HDMI 1.3
Max. video resolutions	2048x1080@60 Hz, 36 bit
Color depth	Deep color support up to 36 bits, 12 bit/color
Audio formats ..	8 channel PCM, Dolby TrueHD, DTS-HD Master Audio 7.1
Reclocking	Pixel Accurate Reclocking
HDCP compliant	Yes

DVI-I port with DVI-D support

DVI port connector type	29-pole, DVI-I
Standard	DVI 1.0
Max. video resolutions	2048x1080@60 Hz, 36 bit
Color depth	Deep color support up to 36 bits, 12 bit/color
Reclocking	Pixel Accurate Reclocking
HDCP compliant	Yes

S/PDIF port

Connector type	RCA receptacle
Audio format	S/PDIF
Supported sample rates	16 to 48 kHz
AES/EBU compatibility	No
Bit depths	Up to 24 bits

Control ports

LAN control

Connector type	RJ45
Standard	10 Base-T or 100 Base-TX (auto-sensing)

Serial control

Serial port connector	9-pole D-sub
Standards	RS-232

11.2. Factory Default Settings

Parameter	Setting/Value
Port settings	
HDCP	Enabled
Input equalization	Auto
Input color range	No change
Output HDMI mode	Auto
Output HDCP mode	Auto
Output color space	Auto
Output color range	Auto
EDID settings	
Emulated EDID at input ports	LWR 1920x1200@59.95Hz UniversalEDID
Network settings	
IP address	192.168.254.254
Subnet mask	255.255.0.0
Static gateway	192.168.0.1
Port number	10001
DHCP	Disabled
Serial port settings	
Baud rate	9600
Databits	8
Parity	No
Stopbits	1

11.3. Factory EDID List

Mem.	Resolution			
F1	640 x	480	@ 60.0	Hz
F2	640 x	480	@ 75.0	Hz
F3	848 x	480	@ 60.0	Hz
F4	800 x	600	@ 50.0	Hz
F5	800 x	600	@ 60.30	Hz
F6	800 x	600	@ 74.99	Hz
F7	1024 x	768	@ 49.98	Hz
F8	1024 x	768	@ 60.0	Hz
F9	1024 x	768	@ 75.2	Hz
F10	1152 x	864	@ 75.0	Hz
F11	1280 x	768	@ 50.0	Hz
F12	1280 x	768	@ 59.92	Hz
F13	1280 x	768	@ 75.0	Hz
F14	1360 x	768	@ 60.1	Hz
F15	1364 x	768	@ 50.0	Hz
F16	1364 x	768	@ 59.93	Hz
F17	1364 x	768	@ 74.98	Hz
F18	1280 x	1024	@ 50.0	Hz
F19	1280 x	1024	@ 60.1	Hz
F20	1280 x	1024	@ 75.1	Hz
F21	1366 x	1024	@ 59.99	Hz
F22	1400 x	1050	@ 49.99	Hz
F23	1400 x	1050	@ 59.99	Hz
F24	1400 x	1050	@ 75.0	Hz
F25	1680 x	1050	@ 59.99	Hz

Mem.	Resolution			
F26	1600 x	1200	@ 50.0	Hz
F27	1600 x	1200	@ 60.0	Hz
F28	1920 x	1200	@ 59.55	Hz
F29	1920 x	1200	@ 50.0	Hz
F30	1440 x	480i	@ 60.3	Hz
F31	640 x	480	@ 59.94	Hz
F32	720 x	480	@ 59.92	Hz
F33	1440 x	576i	@ 50.6	Hz
F34	720 x	576p	@ 50.0	Hz
F35	1280 x	720p	@ 50.0	Hz
F36	1280 x	720p	@ 60.0	Hz
F37	1920 x	1080i	@ 50.3	Hz
F38	1920 x	1080i	@ 50.0	Hz
F39	1920 x	1080i	@ 60.5	Hz
F40	1920 x	1080	@ 24.0	Hz
F41	1920 x	1080	@ 24.99	Hz
F42	1920 x	1080	@ 30.0	Hz
F43	1920 x	1080	@ 50.0	Hz
F44	1920 x	1080	@ 49.99	Hz
F45	1920 x	1080	@ 60.0	Hz
F46	2048 x	1080	@ 49.99	Hz
F47	2048 x	1080	@ 50.0	Hz
F48	2048 x	1080	@ 59.99	Hz
F49	Universal EDID			
F50	2560 x	1600	@ 59.85	Hz

INFO: Please note that minor changes in the factory EDID list may be applied in farther firmware versions

11.4. Mechanical Drawings

The following drawings present the physical dimensions of the receiver. Dimensions are in mm.

Front View

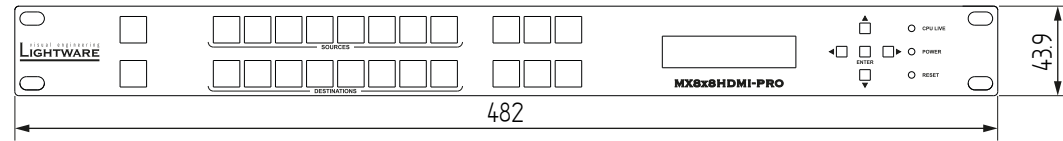

Rear View

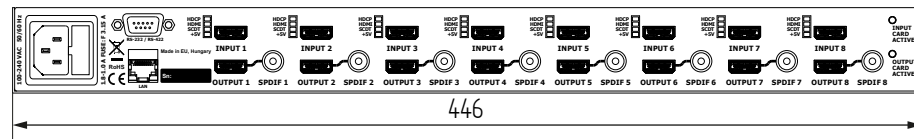

Side View

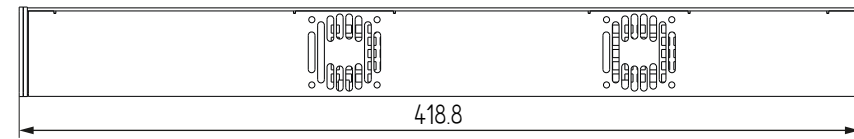

Top View

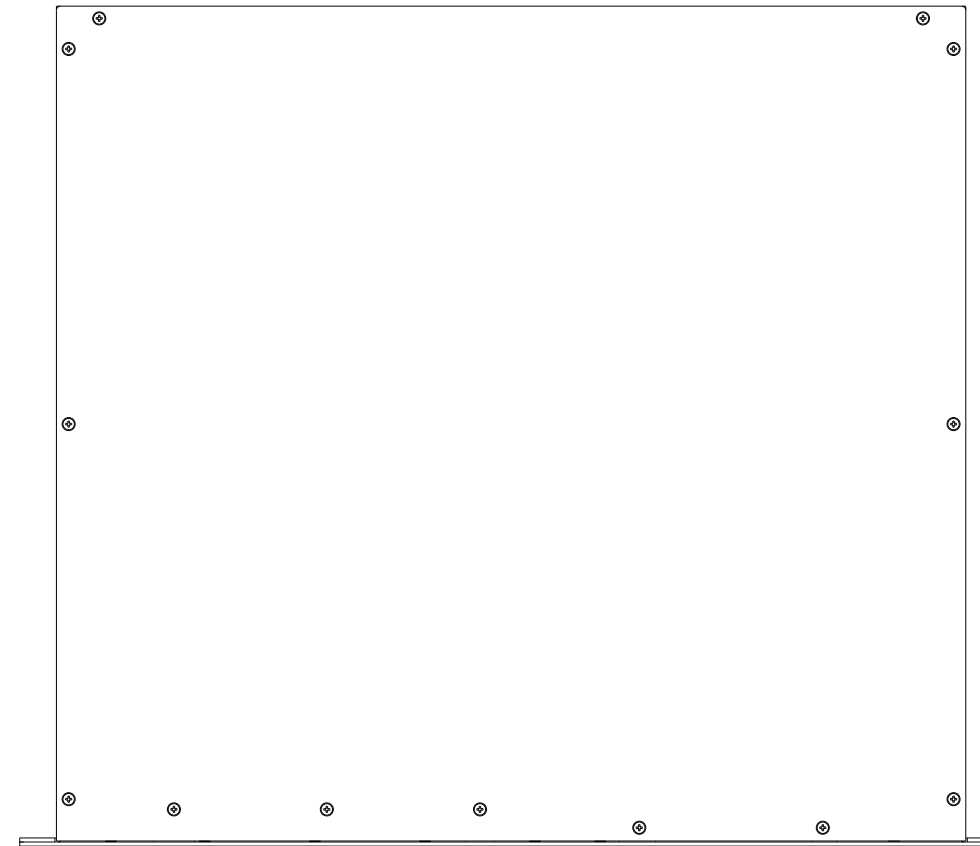

11.5. Further Information

Limited Warranty Statement

1. Lightware Visual Engineering LLC (Lightware) warrants to all trade and end user customers that any Lightware product purchased will be free from manufacturing defects in both material and workmanship for three (3) years from purchase unless stated otherwise below. The warranty period will begin on the latest possible date where proof of purchase/delivery can be provided by the customer. In the event that no proof can be provided (empty 'Date of purchase' field or a copy of invoice), the warranty period will begin from the point of delivery from Lightware.

1.1. 25G and MODEX product series will be subject to a seven (7) year warranty period under the same terms as outlined in this document.

1.2. If during the first three (3) months of purchase, the customer is unhappy with any aspect of a Lightware product, Lightware will accept a return for full credit.

1.3. Any product that fails in the first six (6) months of the warranty period will automatically be eligible for replacement and advanced replacement where available. Any replacements provided will be warranted for the remainder of the original unit's warranty period.

1.4. Product failures from six (6) months to the end of the warranty period will either be repaired or replaced at the discretion of Lightware. If Lightware chooses to replace the product then the replacement will be warranted for the remainder of the original unit's warranty period.

2. The above-stated warranty and procedures will not apply to any product that has been:

2.1. Modified, repaired or altered by anyone other than a certified Lightware engineer unless expressly agreed beforehand.

2.2. Used in any application other than that for which it was intended.

2.3. Subjected to any mechanical or electrical abuse or accidental damage.

2.4. Any costs incurred for repair/replacement of goods that fall into the above categories (2.1., 2.2., 2.3.) will be borne by the customer at a pre-agreed figure.

3. All products to be returned to Lightware require a return material authorization number (RMA) prior to shipment and this number must be clearly marked on the box. If an RMA number is not obtained or is not clearly marked on the box, Lightware will refuse the shipment.

3.1. The customer will be responsible for in-bound and Lightware will be responsible for out-bound shipping costs.

3.2. Newly repaired or replaced products will be warranted to the end of the originally purchased products warranty period.

Document Revision History

Rev.	Release date	Changes	Editor
1.0	04-09-2009	Initial version	Tibor Fejes
1.1	15-12-2015	Safety instructions updated, CE page pulled out	Laszlo Zsedenyi
2.0	26-10-2016	Minor updates to the latest firmware versions, LDC, and LDU versions, updated programmer's reference, updated box contents and warranty info	Tamas Forgacs
2.1	04-07-2017	Safety-related section upgraded	Laszlo Zsedenyi
3.0	30-08-2018	New document format introduced; LDC chapter upgraded.	Laszlo Zsedenyi

Contact Us

sales@lightware.com

+36 1 255 3800

support@lightware.com

+36 1 255 3810

Lightware Visual Engineering LLC.
Peterdy 15, Budapest H-1071, Hungary

www.lightware.com