

visual engineering
LIGHTWARE

User's Manual



HDMI-TPS-RX220AK

HDBaseT™ Multimedia Extender

Important Safety Instructions

Class II apparatus construction.

The equipment should be operated only from the power source indicated on the product.

To disconnect the equipment safely from power, remove the power cord from the rear of the equipment, or from the power source. The MAINS plug is used as the disconnect device, the disconnect device shall remain readily operable.

There are no user-serviceable parts inside of the unit. Removal of the cover will expose dangerous voltages. To avoid personal injury, do not remove the cover. Do not operate the unit without the cover installed.

The appliance must be safely connected to multimedia systems. Follow instructions described in this manual.

Ventilation

For the correct ventilation and to avoid overheating ensure enough free space around the appliance. Do not cover the appliance, let the ventilation holes free and never block or bypass the ventilators (if any).

WARNING

To prevent injury, the apparatus is recommended to securely attach to the floor/wall or mount in accordance with the installation instructions. The apparatus shall not be exposed to dripping or splashing and that no objects filled with liquids, such as vases, shall be placed on the apparatus. No naked flame sources, such as lighted candles, should be placed on the apparatus.

Waste Electrical & Electronic Equipment WEEE

This marking shown on the product or its literature, indicates that it should not be disposed with other household wastes at the end of its working life. To prevent possible harm to the environment or human health from uncontrolled waste disposal, please separate this from other types of wastes and recycle it responsibly to promote the sustainable reuse of material resources. Household users should contact either the retailer where they purchased this product, or their local government office, for details of where and how they can take this item for environmentally safe recycling. Business users should contact their supplier and check the terms and conditions of the purchase contract. This product should not be mixed with other commercial wastes for disposal.

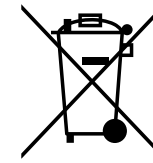

Common Safety Symbols

Symbol	Description
	Direct current
	Alternating current
	Double insulation
	Caution, possibility of electric shock
	Caution

Symbol Legend

The following symbols and markings are used in the document:

WARNING! Safety-related information which is highly recommended to read and keep in every case!

ATTENTION! Useful information to perform a successful procedure; it is recommended to read.

DIFFERENCE: Feature or function that is available with a specific firmware/hardware version or product variant.

INFO: A notice which may contain additional information. Procedure can be successful without reading it.

DEFINITION: The short description of a feature or a function.

TIPS AND TRICKS: Ideas which you may have not known yet but can be useful.

Navigation Buttons

 Go back to the previous page. If you clicked on a link previously, you can go back to the source page by pressing the button.

 Navigate to the Table of Contents.

 Step back one page.

 Step forward to the next page.

Document Information

All presented functions refer to the indicated products. The descriptions have been made during testing these functions in accordance with the indicated Hardware/Firmware/Software environment:

Item	Version
Lightware Device Controller (LDC) software	2.0.0b5
Firmware package	1.4.0
Hardware	1.3

Document revision: **1.0**

Release date: 27-04-2020

Editor: Tamas Forgacs

Hashtag (#) Keywords in the Document

This user's manual contains keywords with hashtag (#) to help you to find the relevant information as quick as possible.

The format of the keywords is the following:

#<keyword>

The usage of the keywords: use the **Search** function (Ctrl+F / Cmd+F) of your PDF reader application, type the # (hashtag) character and the wished keyword.

The **#new** special keyword indicates a new feature/function that has just appeared in the latest firmware or software version.

Example

#dhcp

This keyword is placed at the DHCP (dynamic IP address) setting in the front panel operation, the Lightware Device Controller (LDC) and the LW3 programmer's reference section.

See the list of all hashtag keywords of the document in the [Hashtag Keyword List](#) section, and it is highlighted with **claret** in the table of contents of the document.

About Printing

Lightware Visual Engineering supports green technologies and Eco-friendly mentality. Thus, this document is made for digital usage primarily. If you need to print out few pages for any reason, follow the recommended printing settings:

- Page size: A4
- Output size: Fit to page or Match page size
- Orientation: Landscape

TIPS AND TRICKS: Thanks to the size of the original page, a border around the content (grey on the second picture below) makes possible to organize the pages better. After punching the printed pages, they can be placed easily into a ring folder.

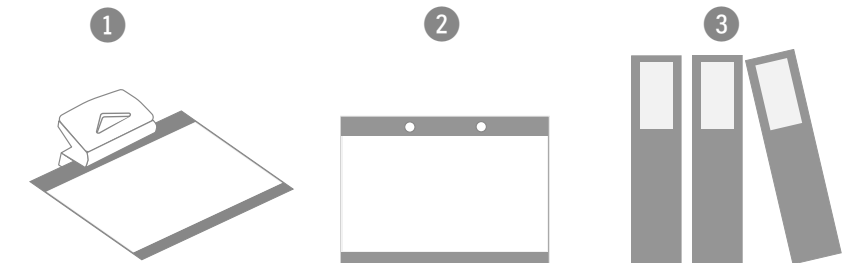

Table of Contents

1. INTRODUCTION	7	4.4. AUDIO INTERFACE	18	5.7.3. Editing an EDID	33
1.1. DESCRIPTION	7	4.4.1. Port Diagram.....	18	5.7.4. Creating an EDID - Easy EDID Creator	34
1.2. COMPATIBLE DEVICES	7	4.4.2. Audio Transmission - Example.....	18	5.8. CONTROL MENU	34
1.3. BOX CONTENTS	7	4.5. USB KVM FUNCTION	18	5.8.1. RS-232.....	34
1.4. FEATURES	8	4.5.1. Port Diagram.....	18	5.8.2. Ethernet.....	36
1.5. TYPICAL APPLICATION	8	4.5.2. USB KVM Extension - Example.....	18	5.8.3. Infra	36
2. PRODUCT OVERVIEW	9	4.6. CONTROL FEATURES	19	5.9. EVENT MANAGER	38
2.1. FRONT VIEW.....	9	4.6.1. Serial Interface	19	5.9.1. The Event Editor.....	38
2.2. REAR VIEW.....	9	4.6.2. RS-232 Recognizer	20	5.9.2. Create or Modify an Event.....	39
2.3. STATUS LEDs AND BUTTON FUNCTIONS	10	4.6.3. IR Interface.....	20	5.9.3. Special Tools and Accessories.....	39
2.3.1. Device Status LEDs	10	4.6.4. Consuming Electronic Control (CEC) Interface	21	5.9.4. Clear One or More Event(s).....	40
2.3.2. Crosspoint Status LEDs and Input Select Button Functionality ...	10	4.6.5. USB Control Interface.....	21	5.9.5. Export and Import Events	40
2.3.3. Function Button	11	4.6.6. Ethernet Interface.....	22	5.9.6. Event Creating - Example	40
2.3.4. Port Status LEDs	11	4.7. FURTHER BUILT-IN FEATURES	22	5.10. SETTINGS MENU	41
2.3.5. Ethernet Status LEDs	11	4.7.1. Automatically Launched Actions – The Event Manager.....	22	5.10.1. Status	41
2.4. SPECIAL BUTTON FUNCTIONS	12	4.7.2. Receiver Cloning – Configuration Backup and Restore.....	22	5.10.2. Network.....	41
2.4.1. Programable Function Button.....	12	4.7.3. Remote Firmware Upgrade of Connected Lightware Devices.....	22	5.10.3. Front Panel.....	42
2.4.2. Enable DHCP (Dynamic IP Address) Setting	12	4.8. SOFTWARE CONTROL MODES	22	5.10.4. Backup	42
2.4.3. Reset to Factory Default Settings.....	12	5. SOFTWARE CONTROL - LIGHTWARE DEVICE CONTROLLER	23	5.10.5. System	42
2.4.4. Entering Bootload Mode	12	5.1. INSTALL AND UPGRADE	23	5.11. THE BUILT-IN MINIWEB	43
3. INSTALLATION	13	5.2. RUNNING THE LDC	23	5.11.1. Opening the Miniweb	43
3.1. MOUNTING OPTIONS	13	5.3. ESTABLISHING THE CONNECTION	24	5.11.2. Customization	44
3.1.1. 1U High Rack Shelf.....	13	5.4. CROSSPOINT MENU	25	5.12. CONFIGURATION CLONING (BACKUP TAB)	45
3.1.2. Under-desk Double Mounting Kit.....	13	5.4.1. Video Layer	25	5.12.1. Cloning Steps in a Nutshell.....	45
3.2. ELECTRICAL CONNECTIONS	13	5.4.2. Audio Layer	25	5.12.2. Save the Settings of the Device (Backup).....	45
3.2.1. DC 12V Connection	13	5.4.3. Port Tiles.....	26	5.12.3. Upload the Settings to a Device (Restore).....	45
3.2.2. HDMI Connector.....	13	5.5. PORT PROPERTIES WINDOWS	26	5.12.4. Create and Restore Backups from the Device Memory.....	46
3.2.3. Ethernet Connector (TPS and LAN Ports)	14	5.5.1. Video - TPS In 1	26	5.13. ADVANCED VIEW WINDOW	46
3.2.4. Analog Audio Output	14	5.5.2. Video - HDMI In 2.....	27	6. LW2 PROGRAMMER'S REFERENCE	47
3.2.5. IR Connector	14	5.5.3. Video - HDMI Out 1 and 2.....	27	6.1. PROTOCOL DESCRIPTION	47
3.2.6. USB-A Connector.....	14	5.5.4. Audio - TPS In 1 and HDMI In 2	28	6.2. INSTRUCTIONS FOR THE TERMINAL APPLICATION USAGE	48
3.2.7. RS-232 Connector	14	5.5.5. Audio - HDMI out 1 and 2.....	28	6.3. GENERAL LW2 COMMANDS	48
3.2.8. USB-mini Connector	14	5.5.6. Audio - Analog Audio Out.....	28	6.3.1. List of All Available LW2 Commands	48
3.3. CONNECTING STEPS	15	5.5.7. Autoselect Feature	28	6.3.2. Product Type Query	48
4. DEVICE CONCEPT	16	5.5.8. CEC Controller	29	6.3.3. Control Protocol Query.....	48
4.1. OVERVIEW	16	5.6. DIAGNOSTIC TOOLS	30	6.3.4. Firmware Version Query.....	49
4.2. TPS INTERFACE	16	5.6.1. Frame Detector.....	30	6.3.5. Connection Test.....	49
4.3. VIDEO INTERFACE	17	5.6.2. Cable Diagnostics	30	6.3.6. Serial Number Query	49
4.3.1. Port Diagram.....	17	5.6.3. No Sync Screen (Test Pattern)	31	6.3.7. Device Label Query.....	49
4.3.2. The Autoselect Feature.....	17	5.7. EDID MENU	32	6.3.8. Installed Board Query.....	49
4.3.3. Video Transmission - Example	17	5.7.1. EDID Operations	32	6.3.9. Firmware Version Query for All Controllers	49
		5.7.2. EDID Summary Window	33	6.3.10. Compile Time Query.....	49

Table of Contents

6.3.11. Health Status Query	50	7.3.8. Subscription.....	62	7.6.4. Switching Audio Input to an Output	72
6.3.12. Restarting of the Device.....	50	7.3.9. Notifications about the Changes of the Properties	63	7.6.5. Switching Audio Input to All Outputs	72
6.3.13. Recalling Factory Default Settings	50	7.3.10. Legend for the Control Commands.....	63	7.6.6. Query the Audio Autoselect Settings	73
6.4. CROSSPOINT AND PORT SETTINGS	50	7.4. SYSTEM COMMANDS.....	63	7.6.7. Change the Autoselect Mode	73
6.4.1. Input Switching to an Output	50	7.4.1. Query the Product Name.....	63	7.6.8. Query the Input Port Priority	73
6.4.2. Input Switching to All Outputs	51	7.4.2. Set the Device Label.....	63	7.6.9. Changing the Input Port Priority	74
6.4.3. Mute Output	51	7.4.3. Query the Serial Number.....	63	7.6.10. Mute Input.....	74
6.4.4. Unmute Output	51	7.4.4. Query the Firmware Version	64	7.6.11. Unmute Input	74
6.4.5. Lock Output	51	7.4.5. Identify the Device	64	7.6.12. Lock Input	74
6.4.6. Unlock Output	52	7.4.6. Dark Mode.....	64	7.6.13. Unlock Input.....	74
6.4.7. View Connection State on the Outputs	52	7.4.7. Control Lock.....	64	7.6.14. Mute Output.....	74
6.4.8. View Crosspoint Size	52	7.4.8. Restarting the Device	64	7.6.15. Unmute Output	74
6.4.9. Autoselect Mode Query.....	53	7.4.9. Restore the Factory Default Settings	64	7.6.16. Lock Output	75
6.4.10. Autoselect Mode Change	53	7.5. VIDEO PORT SETTINGS	65	7.6.17. Unlock Output.....	75
6.4.11. Autoselect - Input Priority Query	53	7.5.1. Query the Status of Source Ports.....	65	7.7. ANALOG AUDIO OUTPUT SETTINGS.....	75
6.4.12. Autoselect - Input Priority Change	53	7.5.2. Query the Status of Destination Port	66	7.7.1. Volume Setting (dB)	75
6.5. NETWORK CONFIGURATION	54	7.5.3. Query the Video Crosspoint Setting	66	7.7.2. Volume Setting (dB) in Steps.....	75
6.5.1. IP Status Query.....	54	7.5.4. Switching Video Input to an Output.....	66	7.7.3. Volume Setting (Percent).....	75
6.5.2. IP Address Query.....	54	7.5.5. Switching Video Input to All Outputs	66	7.7.4. Volume Setting (Percent) in Steps	75
6.5.3. IP Address Setting.....	54	7.5.6. Query the Video Autoselect Settings	67	7.7.5. Balance Setting.....	76
6.5.4. Subnet Mask Query	55	7.5.7. Change the Autoselect Mode	67	7.7.6. Balance Setting in Steps	76
6.5.5. Subnet Mask Setting	55	7.5.8. Query the Input Port Priority	67	7.8. NETWORK CONFIGURATION	76
6.5.6. Gateway Address Query.....	55	7.5.9. Changing the Input Port Priority	68	7.8.1. Query the DHCP State	76
6.5.7. Subnet Mask Setting	55	7.5.10. Mute Input.....	68	7.8.2. Change the DHCP State.....	76
6.5.8. Apply Network Settings.....	56	7.5.11. Unmute Input.....	68	7.8.3. Query the IP Address.....	76
6.6. RS-232 SETTINGS	56	7.5.12. Lock Input	68	7.8.4. Change the IP Address (Static)	77
6.6.1. RS-232 Mode Setting	56	7.5.13. Unlock Input.....	68	7.8.5. Query the Subnet Mask.....	77
6.6.2. Local RS-232 Parameters Settings	56	7.5.14. Mute Output.....	68	7.8.6. Change the Subnet Mask (Static).....	77
6.6.3. Link RS-232 Parameters Settings.....	57	7.5.15. Unmute Output	68	7.8.7. Query the Gateway Address	77
6.6.4. Local RS-232 Control Protocol Port Setting	57	7.5.16. Lock Output	69	7.8.8. Change the Gateway Address (Static)	77
6.6.5. Link RS-232 Control Protocol Port Setting.....	57	7.5.17. Unlock Output.....	69	7.8.9. Query the MAC Address.....	77
6.7. LW2 PROTOCOL COMMANDS – QUICK SUMMARY	58	7.5.18. HDCP Setting (Input Port).....	69	7.8.10. Apply Network Settings	77
7. LW3 PROGRAMMER'S REFERENCE	60	7.5.19. HDCP Setting (Output Port).....	69	7.9. RS-232 PORT CONFIGURATION	78
7.1. OVERVIEW.....	60	7.5.20. Test Pattern Generator Mode.....	69	7.9.1. Protocol Setting.....	78
7.2. INSTRUCTIONS FOR THE TERMINAL APPLICATION USAGE.....	60	7.5.21. Test Pattern Generator Clock Source.....	70	7.9.2. RS-232 Operation Mode	78
7.3. PROTOCOL RULES	61	7.5.22. Test Pattern Setting	70	7.9.3. BAUD Rate Setting.....	78
7.3.1. LW3 Tree Structure and Command Structure (examples).....	61	7.5.23. HDMI Mode Settings (Output Port).....	70	7.9.4. Databits Setting.....	78
7.3.2. General Rules.....	61	7.5.24. Query the Recent TPS Mode.....	70	7.9.5. Stopbits Setting	79
7.3.3. Command Types	61	7.5.25. TPS Mode Settings.....	71	7.9.6. Parity Setting	79
7.3.4. Prefix Summary	62	7.6. AUDIO PORT SETTINGS.....	71	7.9.7. Query the Command Injection Mode	79
7.3.5. Error Messages	62	7.6.1. Query the Status of Source Ports.....	71	7.9.8. Change the Command Injection Mode	79
7.3.6. Escaping	62	7.6.2. Query the Status of Destination Port	72	7.10. RS-232 RECOGNIZER	80
7.3.7. Signature.....	62	7.6.3. Query the Audio Crosspoint Setting.....	72	7.10.1. Enable the Recognizer	80

Table of Contents

7.10.2. Set the Delimiter Hex	80	8. TROUBLESHOOTING	93
7.10.3. Set the Timeout	80	8.1. USE CASE STUDIES	93
7.10.4. Query the Last Recognized Serial Message in String Format	80	8.2. HOW TO SPEED UP THE TROUBLESHOOTING PROCESS	95
7.10.5. Query the Last Recognized Serial Message in Hex Format	81	9. TECHNOLOGIES	96
7.10.6. Query the Last Recognized Serial Message in Hash Format	81	9.1. EDID MANAGEMENT	96
7.10.7. Clear the Stored Last Recognized Serial Message	81	9.1.1. Understanding the EDID	96
7.10.8. Query the Last Recognized Serial Message in String Format	81	9.1.2. Advanced EDID Management.....	96
7.10.9. Query the Last Recognized Serial Message in Hex Format	82	9.2. HDCP MANAGEMENT	97
7.10.10. Query the Last Recognized Serial Message in Hash Format ...	82	9.2.1. Protected and Unprotected Content	97
7.10.11. Set the Active Timeout.....	82	9.2.2. Disable Unnecessary Encryption.....	97
7.11. INFRARED PORT CONFIGURATION	82	9.3. PIXEL ACCURATE RECLOCKING	98
7.11.1. Enable Command Injection Mode.....	82	10. APPENDIX	99
7.11.2. Change Command Injection Port Number	83	10.1. SPECIFICATION.....	99
7.11.3. Enable/Disable Output Signal Modulation.....	83	10.2. INPUT/OUTPUT PORT NUMBERING	101
7.12. SENDING MESSAGE VIA THE COMMUNICATION PORTS	83	10.3. CONTENT OF BACKUP FILE.....	101
7.12.1. Sending a TCP Message (ASCII-format) via TCP Port.....	83	10.4. FACTORY DEFAULT SETTINGS.....	102
7.12.2. Sending a TCP Text (ASCII-format) via TCP Port.....	83	10.5. MAXIMUM EXTENSION DISTANCES	102
7.12.3. Sending a TCP Binary Message (HEX-format) via TCP Port	84	10.6. CABLE WIRING GUIDE.....	102
7.12.4. Sending UDP Message (ASCII-format) via TCP Port	84	10.7. FACTORY EDID LIST.....	103
7.12.5. Sending a TCP Text (ASCII-format) via TCP Port.....	84	10.8. MECHANICAL DRAWINGS	104
7.12.6. Sending a UDP Binary Message (HEX-format) via TCP Port.....	84	10.9. HASHTAG KEYWORD LIST	105
7.12.7. Sending a Message (ASCII-format) via Serial Port	84	10.10. FURTHER INFORMATION.....	106
7.12.8. Sending a Text (ASCII-format) via Serial Port	85		
7.12.9. Sending a Binary Message (HEX-format) via Serial Port.....	85		
7.12.10. Using Hexadecimal Codes	85		
7.12.11. Sending Pronto Hex Codes in Little-endian Format via IR Port	85		
7.12.12. Sending Pronto Hex Codes in Big-endian Format via IR Port...	86		
7.13. SENDING CEC COMMANDS	86		
7.13.1. Sending an OSD String.....	86		
7.13.2. Sending a CEC Command in Text Format	87		
7.13.3. Sending a CEC Command in Hexadecimal Format.....	87		
7.14. EDID MANAGEMENT	87		
7.14.1. Query the Emulated EDIDs.....	87		
7.14.2. Query the Validity of a Dynamic EDID	87		
7.14.3. Query the Preferred Resolution of an User EDID	88		
7.14.4. Emulating an EDID to an Input Port.....	88		
7.14.5. Emulating an EDID to All Input Ports	88		
7.14.6. Copy an EDID to User Memory	88		
7.14.7. Deleting an EDID from User Memory	88		
7.14.8. Resetting the Emulated EDIDs.....	88		
7.15. LW3 PROTOCOL COMMANDS - QUICK SUMMARY	89		

1

Introduction

Thank you for choosing Lightware's HDMI-TPS-RX220AK device. In the first chapter we would like to introduce the device highlighting the most important features in the below listed sections:

- ▶ DESCRIPTION
- ▶ COMPATIBLE DEVICES
- ▶ BOX CONTENTS
- ▶ FEATURES
- ▶ TYPICAL APPLICATION

1.1. Description

The Lightware HDMI-TPS-RX220AK receiver offers seamless HDBaseT™ integration with additional Lightware product lines and developments, including TPS matrices and 25G boards. The device receives digital video at a resolution up to 4K, as well as audio and control up to 170 meters over a single CAT cable. Furthermore, the device utilizes control over USB KVM, and can be remotely powered over TPS link with PoE (IEEE 802.3af), a useful array of features to further simplify the operation for system integrators and users.

Model Denomination

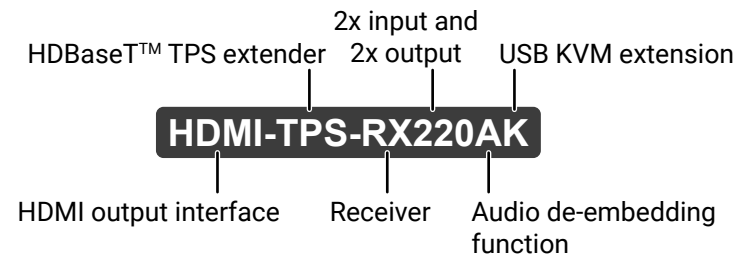

About the Serial Number

Lightware devices contain a label indicating the unique serial number of the product. The structure is the following:

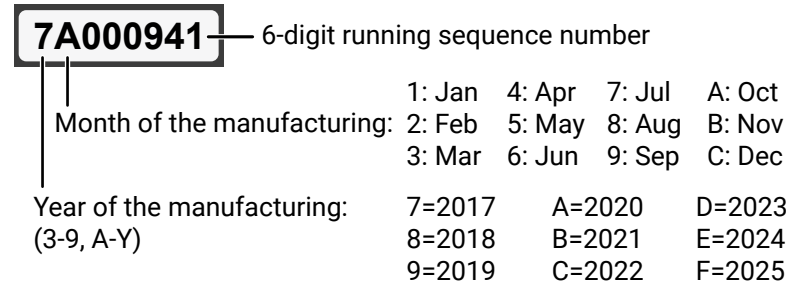

1.2. Compatible Devices

The receiver is compatible with other Lightware TPS transmitters, matrix TPS and TPS2 boards, 25G TPS2 boards, as well as third-party HDBaseT-extenders, displays, but not compatible with the phased out TPS-90 extenders.

ATTENTION! The receiver is PoE-compatible (Power over Ethernet, can be powered remotely via using CATx cable) but the device can only receive power and cannot send power other PoE-compatible devices. Only the TPS connector is PoE-compatible, Ethernet port cannot receive power.

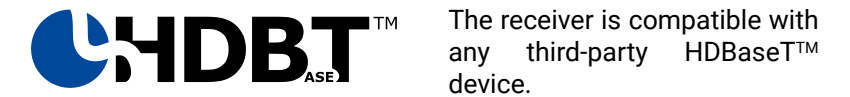

HDBaseT™ and the HDBaseT Alliance logo are trademarks of the HDBaseT Alliance.

USB KVM

The receiver is compatible only with the **UMX-TPS-TX140K** transmitter from the USB KVM extension point of view.

1.3. Box Contents

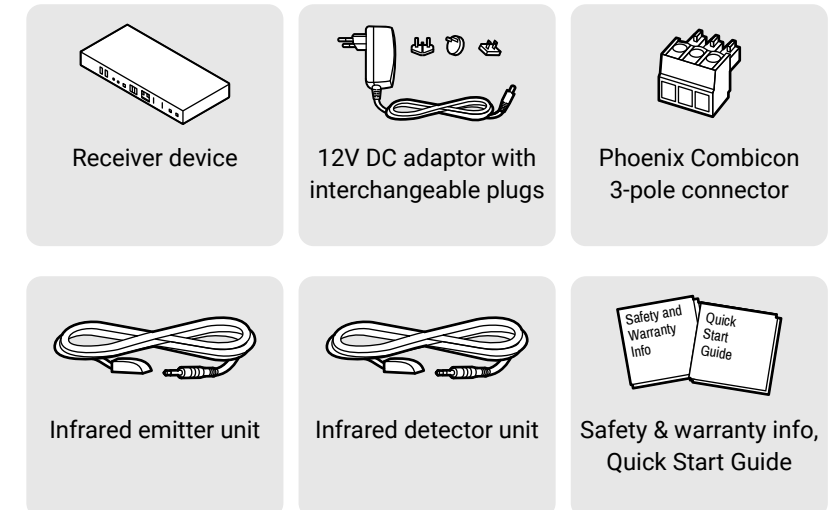

1.4. Features



3D and 4K Support

High bandwidth allows extension of resolutions up to 4K and even 3D sources and displays are supported.



Signal Transmission up to 170 m

Video and audio signal transmission (HDMI, Ethernet, RS-232, and Infra-Red over a single CAT5e...CAT7e cable.



Pixel Accurate Reclocking

Each output has a clean, jitter free signal, eliminating signal instability and distortion caused by long cables or connector reflections.



Frame Detector and Signal Analysis

The exact video and audio signal format can be determined such as timing, frequencies, scan mode, HDCP encryption, color range, color space and audio sample rate.



HDCP-compliant

The receiver fulfills the HDCP standard. HDCP capability on the digital video inputs can be disabled when non-protected content is extended.



Built-in Event Manager

The Event Manager tool takes care of all the necessary control in a smaller configuration by performing predefined actions in response to device status changes. Hence, in a less complex environment, there is no need to invest in additional control solutions, which makes the receiver the best choice for numerous applications.



Audio De-embedder Function

The embedded HDMI audio can be routed to the analog audio output port.



Remote Power

The receiver is PoE-compatible and can be powered locally by the supplied power adaptor, or remotely via the TPS connection (through the CATx cable) with a compatible power source equipment, e.g. MMX6x2-HT series matrix switchers and TPS2 matrix boards.



Bi-directional RS-232 Pass-through

AV systems can also contain serial port controllers and controlled devices. Serial port pass-through supports any unit that works with standard RS-232.



USB KVM Extension

KVM extension for USB HID (Human Interface Devices, e.g. keyboard, mouse, presenter).

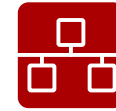

Ethernet Control

Multiple simultaneous TCP/IP connections are available with a simple ASCII-based protocol for controlling, configuring the receiver or perform a firmware upgrade.



Dark Mode

Rental application requires this function, which keeps the LEDs unlit to hide the device during the event.

Advanced Control Features



Consumer Electronic Control

Supports transmitting standard CEC commands in order to remote control the source or sink device.



Infra Message Sending

Infrared (IR) is a wireless technology used for device communication over short ranges. Third party control systems may send IR control commands to endpoints turning them on and off or switching their inputs.



RS-232 Recognizer

Support recognizing incoming RS-232 messages to integrate with 3rd party devices like VC codec.

1.5. Typical Application

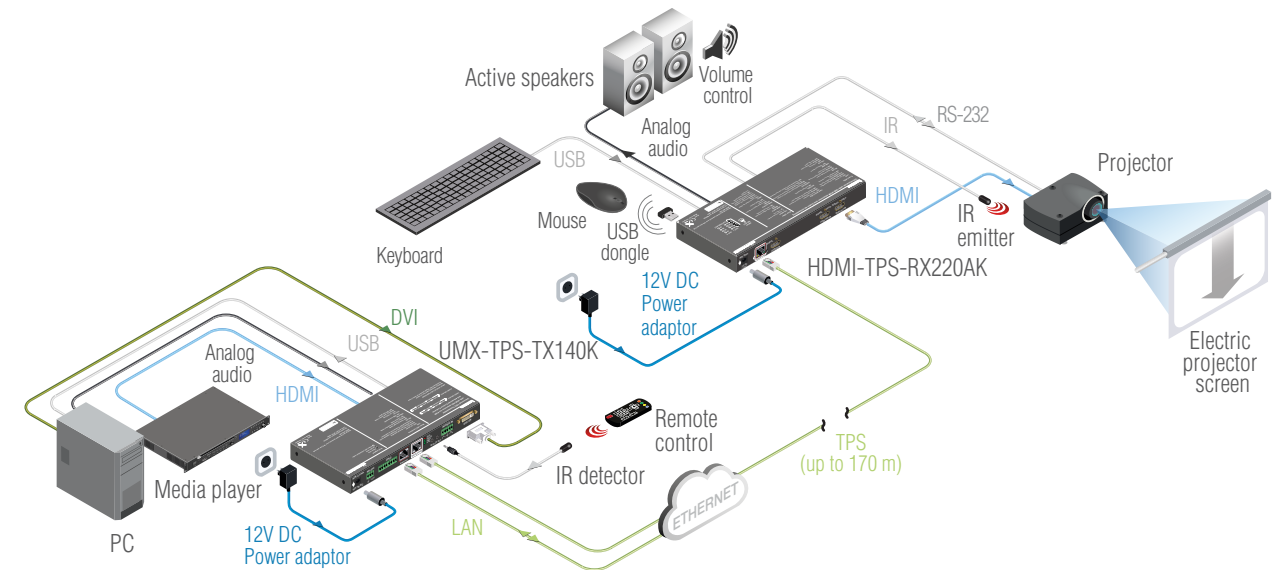

Typical application diagram

2

Product Overview

The following sections are about the physical structure of the device, input/output ports and connectors:

- ▶ [FRONT VIEW](#)
- ▶ [REAR VIEW](#)
- ▶ [STATUS LEDs AND BUTTON FUNCTIONS](#)
- ▶ [SPECIAL BUTTON FUNCTIONS](#)

2.1. Front View

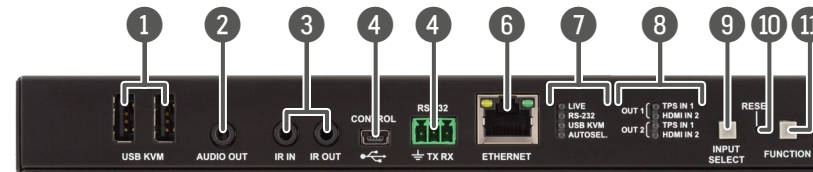

- 1 **USB A-type connectors** USB KVM ports for HID-compatible devices (preferably keyboard and mouse).
- 2 **Analog audio output** TRS (3.5mm jack) connector for unbalanced analog audio output. Pin assignments can be found in the [Analog Audio Output](#) section.
- 3 **Infrared connectors** 3-pole TRS connector, also known as 3.5 mm (1/8") jack plug for optional IR receiver (IR IN) and transmitter (IR OUT). Pin assignments can be found in the [IR Connector](#) section.
- 4 **USB mini-B connector** USB interface for LDC connection to control and configure the device.
- 5 **RS-232 connector** 3-pole Phoenix connector for controlling the device with LDC or third-party control systems. Pin assignment can be found in the [RS-232 Connector](#) section.
- 6 **Ethernet** Locking RJ45 connector for controlling the device with LDC or third-party control systems and LDU for firmware upgrade.
- 7 **Device status LEDs** The LEDs give immediate feedback about current state of the device. See the details in the [Device Status LEDs](#) section.
- 8 **Crosspoint status LEDs** LEDs give feedback about the current status of the AV crosspoint settings. See the details in the [Crosspoint Status LEDs and Input Select Button Functionality](#) section.

- 9 **Input select button** Pushing the button selects video source for HDMI out 1 and 2 ports. See the pre-programmed crosspoint states in the [Crosspoint Status LEDs and Input Select Button Functionality](#) section.
- 10 **Reset button** Pressing reset button reboots the extender.
- 11 **Function button** Special functions are available with this button (bootload mode, DHCP settings, restore factory default settings, condition launching in Event Manager). For the details about special functions see the [Special Button Functions](#) section.

2.2. Rear View



- 1 **12V DC input connector** 12V DC input for local powering.
- 2 **TPS input port** TPS input port for the compatible transmitter device (extender / matrix / board). The port is PoE-compatible and is able to receive
- 3 **HDMI input port** HDMI input port for DVI or HDMI signal. Connect an HDMI cable between the receiver and the source device.
- 4 **HDMI out 1 port** HDMI output 1 port for the sink device. The source of the port can be selected with the Input Select button. Connect HDMI cables between the receiver and the sink devices.
- 5 **HDMI out 2 port** HDMI output 2 port for the sink device. The source of the port can be selected with the Input Select button. Connect HDMI cables between the receiver and the sink devices.

2.3. Status LEDs and Button Functions

2.3.1. Device Status LEDs



LIVE		
	off	The device is not powered or out of operation.
	blinking (slow, 1 sec)	The device is powered and operational.
	blinking (fast, 0,5 sec)	The device is in bootload (firmware upgrade) mode.
	on	The device is powered but not operational.
RS-232		
	off	RS-232 ports (local and link) are in Pass-through mode.
	blinking	Command Injection mode is active.
	on	RS-232 ports (local and link) are in Control mode.
USB KVM		
	off	USB is not enumerated.
	on	USB is enumerated.
AUTOSEL. (AUTOSELECT)		
	off	Autoselect is disabled.
	blinking	Autoselect is enabled but no signal is present on the selected input.
	on	Autoselect is enabled and signal is present on the selected input.

2.3.2. Crosspoint Status LEDs and Input Select Button Functionality

The source signal for the HDMI output ports can be selected by pushing the **Input Select** button. Five pre-programmed crosspoint states can be applied:



No.	Button operation	Crosspoint settings	Crosspoint status LEDs
1.	1x short press 	I1 -> 01 I1 -> 02	
2.	1x short press 	I1 -> 01 I2 -> 02	
3.	1x short press 	I2 -> 01 I1 -> 02	
4.	1x short press 	I2 -> 01 I2 -> 02	
5.	1x short press 	Autoselect See the details about this feature in the The Autoselect Feature section.	Depends on the actual Autoselect mode.

2.3.3. Function Button

The source signal for the Analog audio output port can be selected by pushing the **Function** button as follows:



No.	Button operation	Crosspoint settings
1.	<p>1x short press</p>	I1 -> O3
2.	<p>1x short press</p>	I2 -> O3

2.3.4. Port Status LEDs

TPS Input LEDs

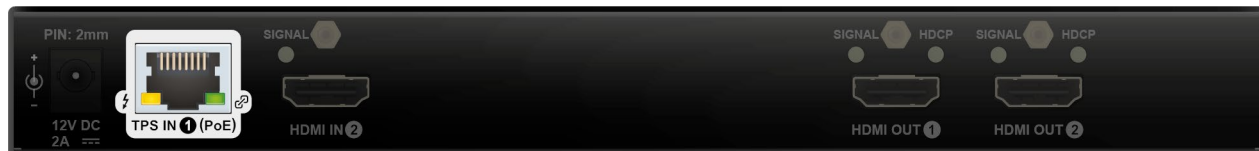

⚡ PoE		
<input type="checkbox"/>	off	Remote power receiving (PoE) is inactive.
<input checked="" type="checkbox"/>	on	Remote power receiving (PoE) is active.
🔗 TPS LINK		
<input type="checkbox"/>	off	No TPS link between transmitter and receiver.
<input style="border: 1px dashed green; border-radius: 50%;" type="checkbox"/>	blinking	Device is in low power mode or in Ethernet fallback mode.
<input checked="" type="checkbox"/>	on	TPS link is active.

2.3.5. Ethernet Status LEDs



Amber LED		
<input type="checkbox"/>	off	Not linked.
<input style="border: 1px dashed yellow; border-radius: 50%;" type="checkbox"/>	blinking	Linked but there is no activity.
<input checked="" type="checkbox"/>	on	Linked and activity is present.
Green LED		
<input type="checkbox"/>	off	0 Mbit/s
<input checked="" type="checkbox"/>	on	100 Mbit/s

Signal LED

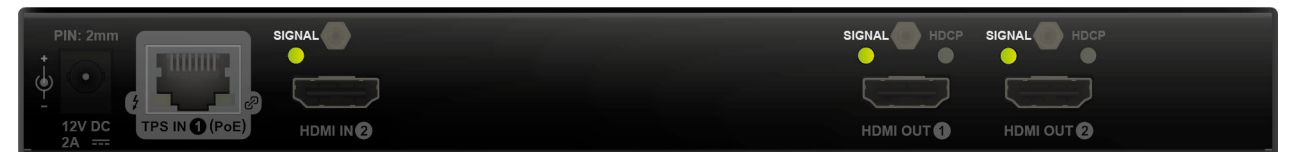

SIGNAL		
<input type="checkbox"/>	off	Input or output signal is not present or muted.
<input checked="" type="checkbox"/>	on	Signal is present.

HDCP LED

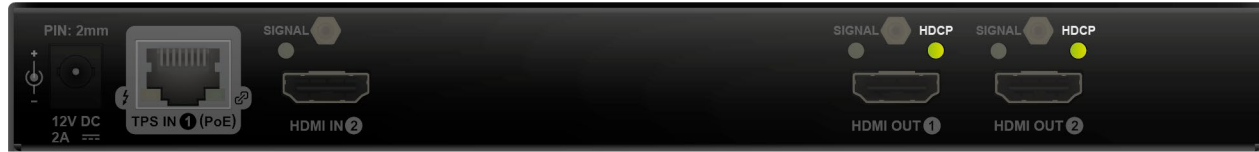

HDCP		
	off	Output signal is not HDCP-encrypted.
	blinking	Non-HDCP capable device is connected, encrypted signal is replaced with red screen.
	on	Output signal is HDCP-encrypted.

2.4. Special Button Functions

2.4.1. Programable Function Button

Action or an operation can be assigned to the **Function** button. “Function button pressed” is a condition that can be selected in the [Event Manager](#). *#function*

2.4.2. Enable DHCP (Dynamic IP Address) Setting

The device gets a static IP address as a factory default setting. If this setting does not fit to the circumstances during install or usage, DHCP can be enabled from the front panel:

- Step 1.** Make sure the device is powered on and operational.
- Step 2.** Press and keep pressed the **Function** button for 5 seconds.
- Step 3.** After 5 seconds front panel LEDs start blinking; release the button and press it 3 times again quickly (within 3 seconds).
- Step 4.** The LEDs get dark, DHCP gets enabled. *#dhcp*

2.4.3. Reset to Factory Default Settings

To restore factory default values, do the following steps:

- Step 1.** Make sure the device is powered on and operational.
- Step 2.** Press and keep pressed the **Function** button for 10 seconds. After 5 seconds front panel LEDs start blinking but keep on pressing the button.
- Step 3.** After 10 seconds the blinking gets faster; release the button and press it 3 times again quickly (within 3 seconds).
- Step 4.** The LEDs get dark, the device restores the factory default settings and reboots.

Factory default settings are listed in the [Factory Default Settings](#) section. *#factory*

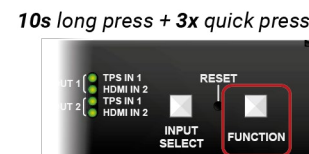
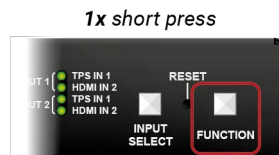

2.4.4. Entering Bootload Mode

It may happen that the firmware upgrade process is not successful as the device cannot be switched to bootloader mode automatically. In this case, receiver device can be forced to switch to bootloader mode as follows:

- Step 1.** Make sure the receiver is powered off.
- Step 2.** Press and keep pressed the **Function** button.
- Step 3.** Power on the receiver. If the device is switched to bootloader mode the LIVE LED is blinking quickly (less than 500 ms duty cycle). The other LEDs are off. *#bootload*

Long press + plug power cord

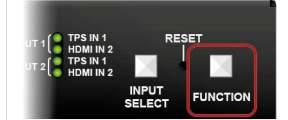

3

Installation

The chapter is about the installation of the device and connecting to other appliances, presenting also the mounting options, the electrical connections and further assembly steps:

- ▶ MOUNTING OPTIONS
- ▶ ELECTRICAL CONNECTIONS
- ▶ CONNECTING STEPS

3.1. Mounting Options

To mount the receiver Lightware supplies optional accessories for different usage. There are two kinds of mounting kits with similar fixing method. The receiver has two mounting holes with inner thread on the bottom side; see the bottom view in the [Mechanical Drawings](#) section. Fasten the device by the screws enclosed to the accessory:

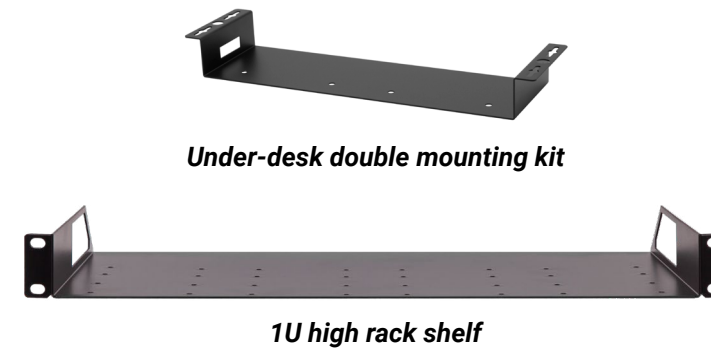

The Under-desk double mounting kit makes easy to mount a single device on any flat surface, e.g. furniture. 1U high rack shelf provides mounting holes for fastening two half-rack or four quarter-rack sized units. Pocket-sized devices can also be fastened on the shelf. To order mounting accessories please contact sales@lightware.com.

WARNING! Always use the supplied screws. Using different (e.g. longer) ones may cause damage to the device.

INFO: The receiver is half-rack sized.

3.1.1. 1U High Rack Shelf

Allows rack mounting for half-rack, quarter-rack and pocket sized units.

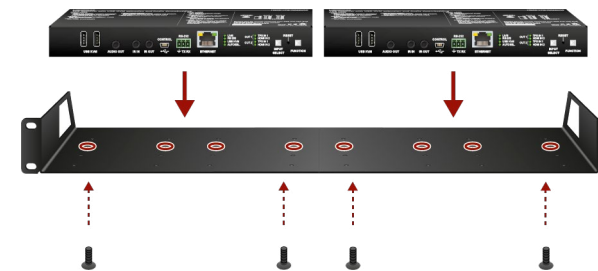

1U high rack shelf provides mounting holes for fastening two half-rack or four quarter-rack sized units. Pocket sized devices can also be fastened on the self.

3.1.2. Under-desk Double Mounting Kit

The UD-kit double makes it easy to mount a single receiver on any flat surface (e.g. furniture).

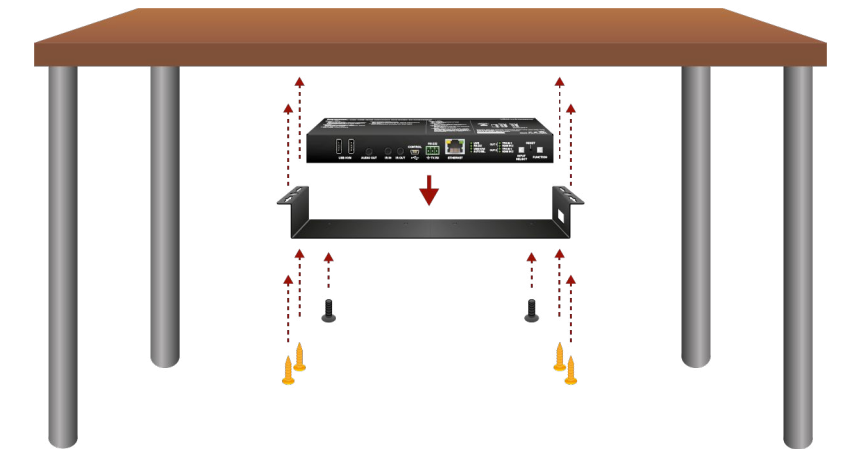

INFO: The chipboard screws are not supplied with the mounting kit.

3.2. Electrical Connections

3.2.1. DC 12V Connection

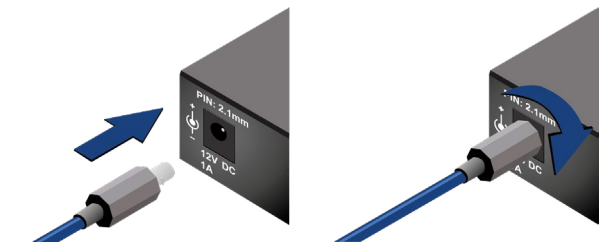

Locking DC connector

Do not forget to turn the plug clockwise direction before disconnecting the power adaptor.

WARNING! Always use the supplied 12V power adaptor. Warranty void if damage occurs due to use of a different power source.

3.2.2. HDMI Connector

The extender provides standard 19 pole HDMI connector for input and output. The connectors support HDMI 1.4 standard up to 4K30 resolution. Always use high quality HDMI cable for connecting sources and displays. 

You can find more information about video functions in the [Video Interface](#) section.

3.2.3. Ethernet Connector (TPS and LAN Ports)

The extender provides standard RJ45 connectors for TPS IN 1 and LAN ports. Always use high quality Ethernet cable for connecting transmitters and receivers. Maximum CATx cable distances can be found in the [Maximum Extension Distances](#) section.



RJ45 connector for LAN port **RJ45 connector for TPS input port**

Wiring of TPS and LAN Cables

Lightware recommends the termination of LAN cables on the basis of TIA/EIA T 568 A or TIA/EIA T 568 B standards.

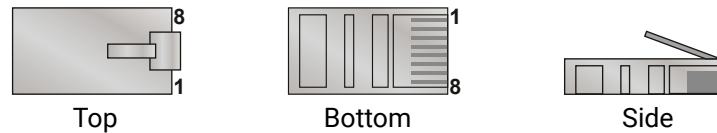

Pin	TIA/EIA T568 A	Color and name	TIA/EIA T568 B	Color and name
1		white/green stripe		white/orange stripe
2		green solid		orange solid
3		white/orange stripe		white/green stripe
4		blue solid		blue solid
5		white/blue stripe		white/blue stripe
6		orange solid		green solid
7		white/brown stripe		white/brown stripe
8		brown solid		brown solid

You can find more information about TPS interface in the [TPS Interface](#) section.

3.2.4. Analog Audio Output

The connector is used for receiving unbalanced analog audio signal. It is also known as (3.5 mm or approx. 1/8") audio jack, phone jack, phone plug and mini-jack plug.



Jack audio plug pin assignments

Pin nr.	Signal
1	Left
2	Right
3	Ground

You can find more information about audio functions in the [Audio Interface](#) section.

3.2.5. IR Connector

IR detector and IR emitter can be connected to the receiver with TRS (Tip, Ring, and Sleeve) connectors. They are also known as (3,5 mm or approx. 1/8") audio jack, phone jack, phone plug, and mini-jack plug. The pin assignments are the following for the detector and the emitter:

Detector – 3-pole TRS		Emitter – 2-pole TS	
1 Tip	Signal (active low)	1 Tip	+5V
2 Ring	GND	2 Ring	Signal (active low)
3 Sleeve	+5V	3 Sleeve	

INFO: Ring pole of the emitter is optional. If your IR emitter has three-pole TRS plug, then the Ring and the Sleeve are the same signal (Output -).

You can find more information about Infrared interface in the [IR Interface](#) section.

3.2.6. USB-A Connector

The extender provides USB connectors for supporting KVM functionality. The device has 2x USB 2.0 A-type connectors.



You can find more information about USB KVM function in the [USB KVM Function](#) section.

3.2.7. RS-232 Connector

The receiver contains a 3-pole Phoenix connector which is used for RS-232 serial connection.

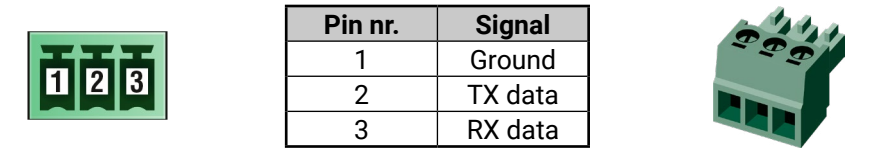

RS-232 connector pin assignments

Pin nr.	Signal
1	Ground
2	TX data
3	RX data

Compatible Plug Type

Phoenix® Combicon series (3.5mm pitch, 3-pole), type: MC 1.5/3-ST-3.5.

You can find more information about RS-232 interface in the [Serial Interface](#) section and about the cable wiring in the [Cable Wiring Guide](#) section.

3.2.8. USB-mini Connector

The extender provides standard USB 2.0 mini B-type connector for software control purpose.



3.3. Connecting Steps

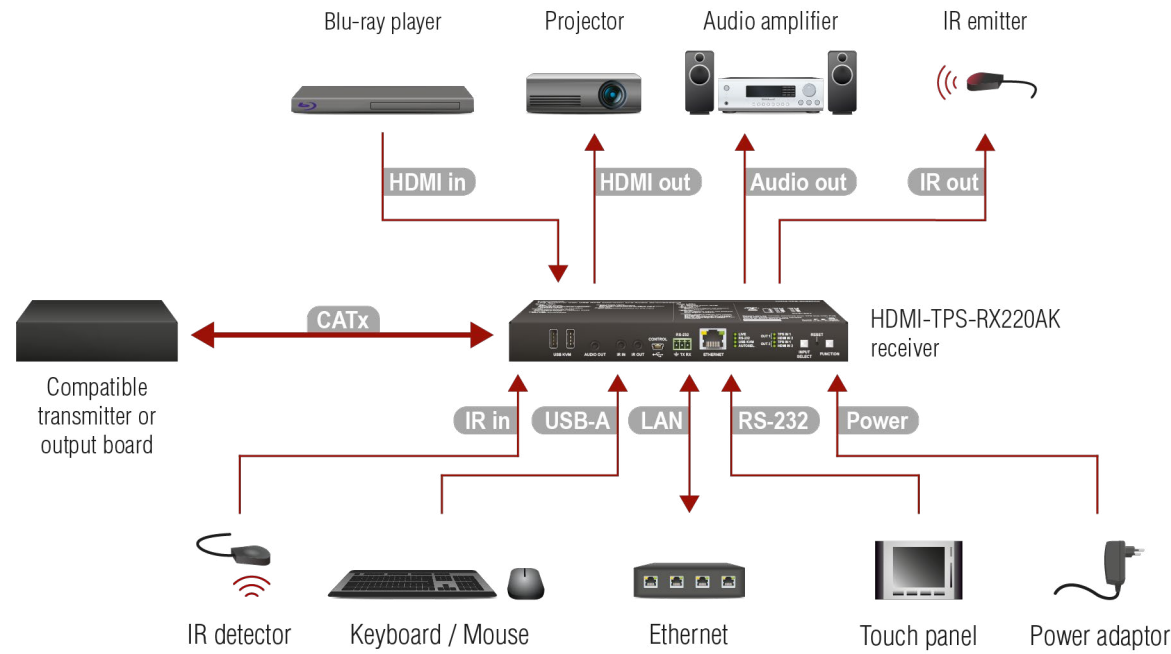

CATx Connect the compatible transmitter or the matrix output board and the receiver unit by a CATx cable via the TPS connectors.

HDMI in Connect the receiver and the HDMI source device (e.g. Blu-ray player) by a HDMI cable via the HDMI input port.

HDMI out Connect the sink devices (e.g. projector) to the HDMI output 1 and 2 ports by HDMI cables.

Audio out Optionally connect an audio device (e.g. an audio amplifier) to the audio output port.

USB-A Optionally for USB HID extension: connect the USB HID devices to the receiver (preferably mouse and keyboard).

IR in Optionally for Infrared extension:
IR out - Connect the IR emitter to the IR OUT port of the receiver.
 - Connect the IR detector to the IR IN port of the receiver.

RS-232 Optionally for RS-232 extension: connect a controller/controlled device (e.g. touch panel) to the RS-232 port. See the wiring guide for the Phoenix 3-pole connector in the [Cable Wiring Guide](#) section.

LAN Optionally connect the receiver to a LAN network in order to control the device.

Power See powering options on the next section.

Powering Options

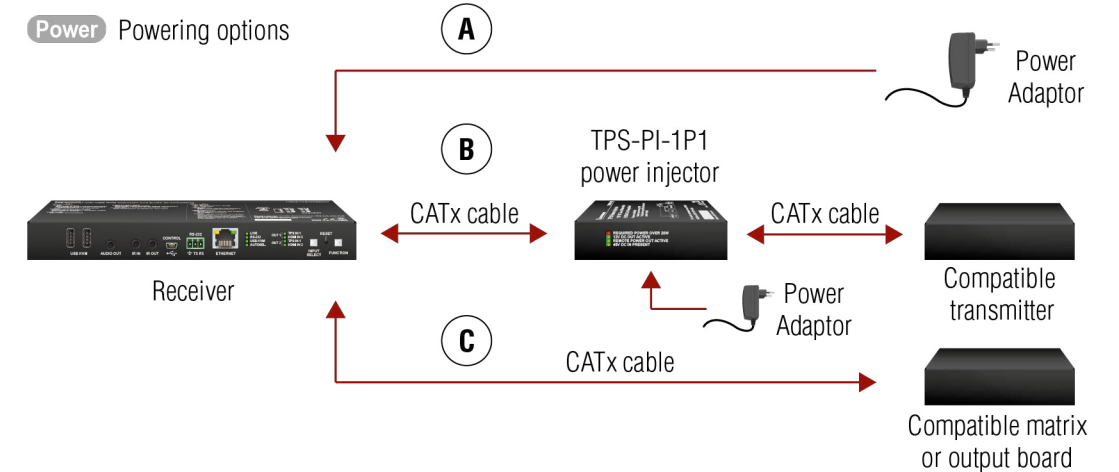

A **Using local PSU** - connect the 12V power adaptor to the DC input on the receiver first, then to the AC power socket.

B **Using PoE with connecting a transmitter**: connect the TPS IN (PoE) port of the receiver to the TPS+PoE output port of the TPS-PI-1P1 power injector by a CATx cable as well as connect the TPS output port of the transmitter to the TPS port of the TPS-PI-1P1 by a CATx cable.

C **Using PoE with connecting a matrix or an output board**: connect the TPS IN (PoE) port of the receiver to the PoE-compatible TPS output port of the matrix or output board by a CATx cable.

ATTENTION! In case of connecting the receiver to an output board of the matrix always connect an external PSU to the board. For the detailed information please read the user's manual of the matrix.

ATTENTION! The Ethernet port does not support PoE. Only the TPS port support PoE function.

INFO: If both remote and local power sources are connected, the remote power will be used.

4

Device Concept

The following chapter describes the features of the device with few real-life examples. The topics that are described:

- ▶ [OVERVIEW](#)
- ▶ [TPS INTERFACE](#)
- ▶ [VIDEO INTERFACE](#)
- ▶ [AUDIO INTERFACE](#)
- ▶ [USB KVM FUNCTION](#)
- ▶ [CONTROL FEATURES](#)
- ▶ [FURTHER BUILT-IN FEATURES](#)
- ▶ [SOFTWARE CONTROL MODES](#)

4.1. Overview

HDMI-TPS-RX220AK is a multifunctional TPS receiver with audio de-embedding function and USB KVM feature. The device receives audio/video, Ethernet, RS-232 and Infrared signals via the TPS input port and can be powered by another extender due to the PoE-capability. The receiver can be controlled via USB, Ethernet, RS-232 or Infrared and is able to control third-party devices via the RS-232, Ethernet, Infrared and USB KVM.

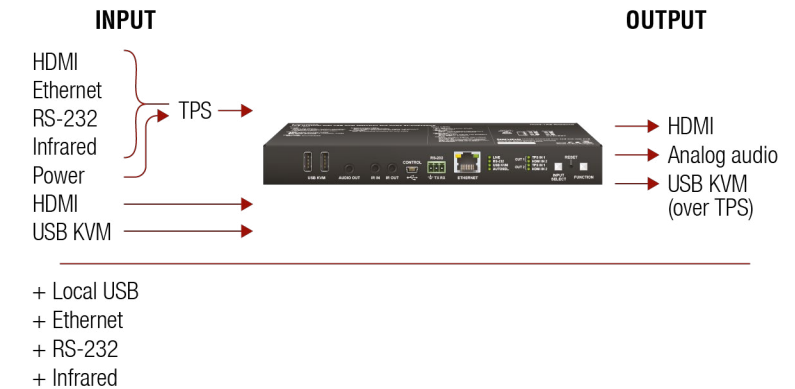

Signal overview of HDMI-TPS-RX220AK receiver

4.2. TPS Interface

The device is built with TPS (Twisted Pair Single) interface which are using HDBase™ technology. It means the unit receives **video, audio, Ethernet, RS-232 and Infrared signals** via a single CATx cable.

TPS Interface Working Modes

The TPS working mode between the transmitter and the receiver is determined by the mode set in them. Both devices TPS mode settings together determine the finally established TPS transmission mode.

The following TPS modes are defined in the receiver:

- **Auto:** The TPS mode is determined automatically.
- **HDBaseT:** Ideal for high resolution signals up to 4K.
- **Long reach:** Ideal for big distances up to 1080p@60Hz with extended cable lengths.
- **LPPF1*:** Only RS-232 communication is transmitted (@ 9600 baud).
- **LPPF2*:** Only RS-232 (@ 9600 baud) and Ethernet communication are transmitted.

* LPPF: Low Power Partial Functionality.

		Selected mode on RX side				
		LPPF1	LPPF2	HDBaseT	Long reach	Auto
Selected mode on TX side	LPPF1	LPPF1	LPPF1	LPPF1	LPPF1	LPPF1
	LPPF2	LPPF1	LPPF2	LPPF2	LPPF2	LPPF2
	HDBaseT	LPPF1	LPPF2	HDBaseT	Long reach	HDBaseT
	Long reach	LPPF1	LPPF2	Long reach	Long reach	Long reach
	Auto	LPPF1	LPPF2	HDBaseT	Long reach	HDBaseT **

** If there is valid HDMI/DVI signal is on the TX side, the TPS mode will be HDBaseT on both side. If the transmitter does not transmits HDMI/DVI signal, the TPS mode will be changed to LPPF2 or LPPF1 automatically. Long reach mode is not available when both sides are set to Auto mode.

When using automatic operation mode selection, the device determines the mode of operation. If both halves are set to Auto mode, the source side is the initiator. It will negotiate each state transition with its sink side partner.

When one of the devices is configured to manual operation mode selection, the other device may be placed in automatic mode. In this case, the mode transition negotiation is initiated by the host-managed device and the auto-mode device follows through. The allowed cable lengths and resolutions are listed in the [Maximum Extension Distances](#) section.

4.3. Video Interface

4.3.1. Port Diagram

The following figure describes the video port diagram of the device:

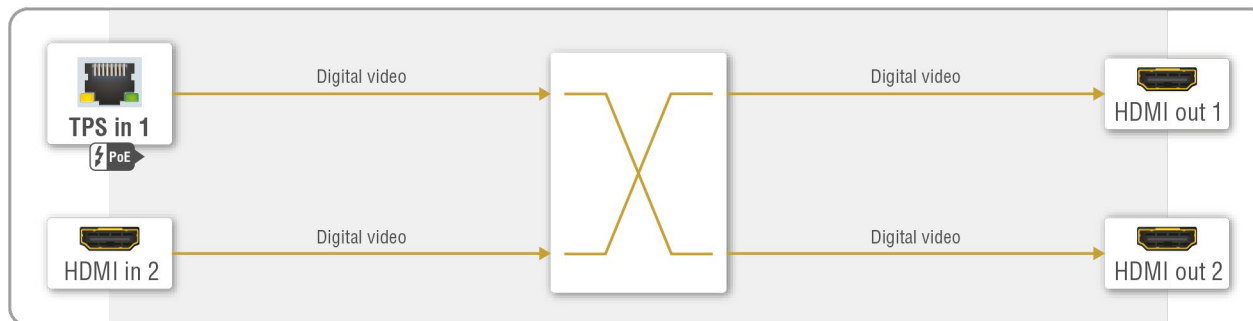

Video port diagram of the device

The device can receive two HDMI or DVI signals up to 4K30 (4096x2160@30Hz) resolution. The streams can be routed to any HDMI output ports over the 2x2 digital video crosspoint. The HDMI outputs can transmit HDMI or DVI signals up to 4K UHD 30 Hz (3840x2160@30Hz) resolution.

Crosspoint Settings

The crosspoint can be set by four different methods:

- Using **Input Select button** on the front panel; see the details in the [Crosspoint Status LEDs and Input Select Button Functionality](#) section.
- Using the **Lightware Device Controller (LDC)** software; see the details in the [Crosspoint Menu](#) section.
- Using **LW2 protocol command**; see the details in the [Crosspoint and Port Settings](#) section.
- Using **LW3 protocol command**; see the details in the [Video Port Settings](#) section.

4.3.2. The Autoselect Feature

Beside the manual selecting of crosspoints you can choose the Autoselect option both in case of audio and video ports.

There are three types of Autoselect as follows:

- First detect mode:** selected input port is kept connected to the output while it has an active signal.
- Priority detect mode:** always the highest priority active input is selected to transmit.
- Last detect mode:** always the last attached input is selected to transmit.

4.3.3. Video Transmission - Example

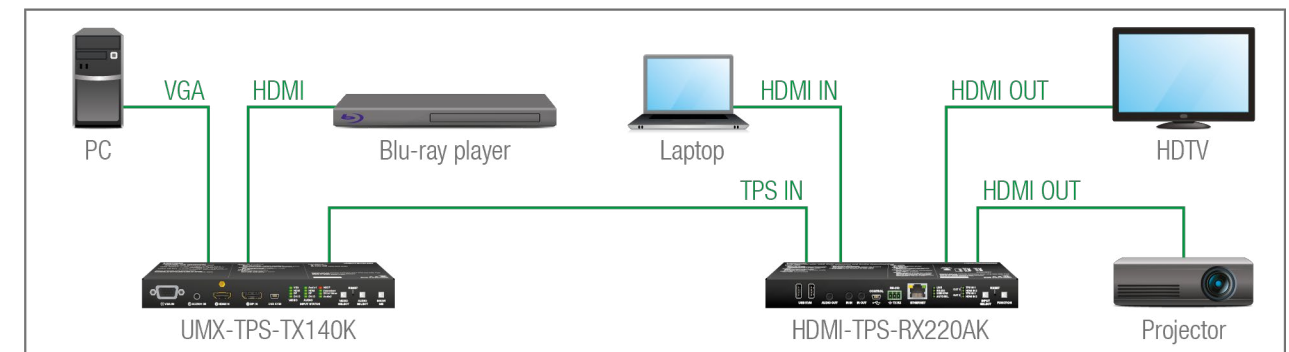

The Concept

The UMX-TPS-TX140K transmitter device has two video sources: a PC which sends analog video signal over VGA; and a Blu-ray player which sends digital video signals over HDMI. The transmitter transmits one of the video signal over TPS interface to the receiver. The transmitted signal is always converted to digital HDMI with embedded audio signal.

The HDMI-TPS-RX220AK receiver has has two source devices: the transmitter over TPS; and a laptop over HDMI. The two video signals can be routed to any sink devices which are connected to the device: the HDTV and the projector.

4.4. Audio Interface

4.4.1. Port Diagram

The following figure describes the audio port diagram of the device:

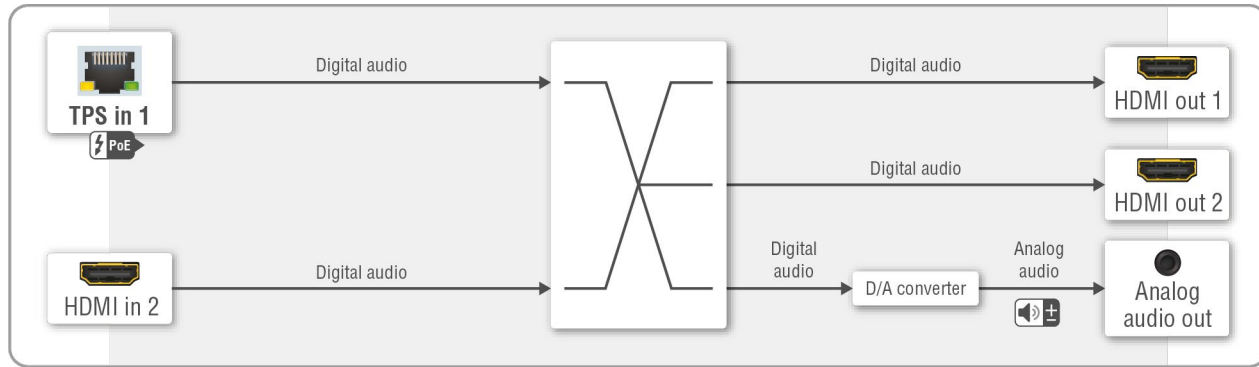

Audio port diagram of the device

The device can receive two digital audio signal from the TPS and HDMI input ports. The signals are routed to a 2x3 digital audio crosspoint and can be transmitted to three outputs: the HDMI out 1 and 2 ports; and the analog audio output.

The audio stream of both HDMI input signal can be de-embedded and can be routed to the analog audio output after a digital/analog conversion.

4.4.2. Audio Transmission - Example

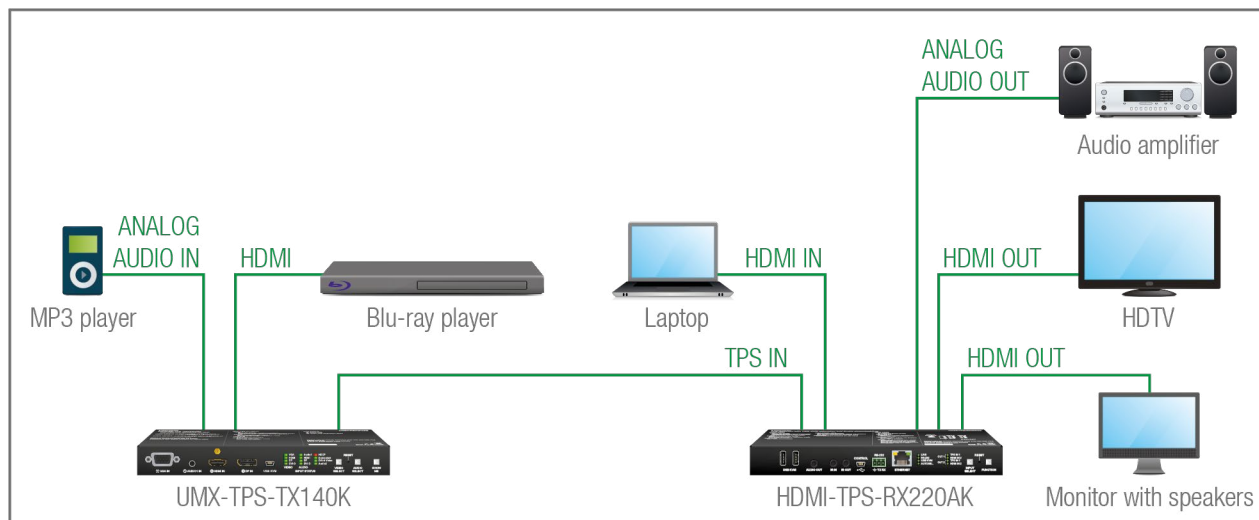

The Concept

The UMX-TPS-TX140K transmitter device has two audio sources: an MP3 player with analog audio signal and a Blu-ray player with embedded HDMI audio. Any of these signals (one in the same time) can be transmitted to the receiver over the TPS interface.

The HDMI-TPS-RX220AK receiver has two audio sources: the transmitter over the TPS interface and the laptop over HDMI. The receiver can transmit both audio signals to any of the three outputs: two HDMI output and the analog audio output.

4.5. USB KVM Function

ATTENTION! The USB KVM extension works with the UMX-TPS-TX140K transmitter model only.

4.5.1. Port Diagram

The following figure describes the port diagram of the USB KVM feature:

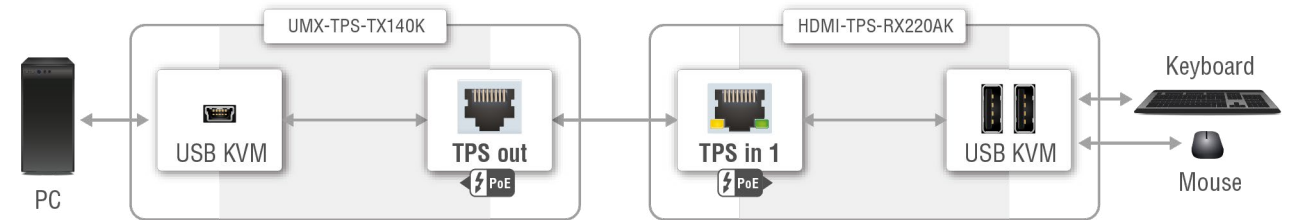

USB KVM port diagram of the receiver and the transmitter

The controller devices (e.g. keyboard, mouse) are connected to the HDMI-TPS-RX220AK receiver. The USB signal are transmitted to the transmitter over the TPS interface. The controlled device (e.g. PC) is connected to the UMX-TPS-TX140K transmitter.

4.5.2. USB KVM Extension - Example

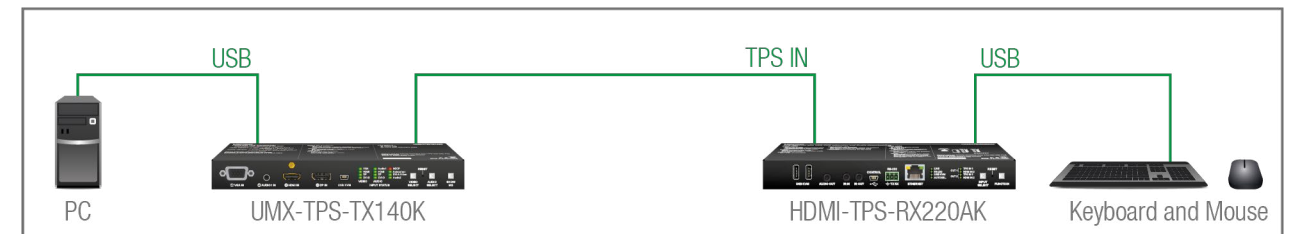

The Concept

The HDMI-TPS-RX220AK device transmits the USB control signals of the keyboard and the mouse to the UMX-TPS-TX140K transmitter over the TPS interface. Thereby the PC can be controlled by the USB HID devices from a distance up to 150 m.

4.6. Control Features

HDMI-TPS-RX220AK receiver has several control functions. This section is about to present the possibilities of the different control interfaces, e.g. RS-232, Infrared, Ethernet, CEC and USB.

4.6.1. Serial Interface

Technical Background

Serial data communication can be established via the local RS-232 port (Phoenix connector) or via the TPS lines. The RS-232 ports – which are connected to the CPU – can be configured separately (e.g. if the Baud rates are different, the CPU does the conversion automatically between the ports). The RS-232 port can be switched to **Pass-through mode**, **Control mode**, or **Command Injection mode**; see the figure below.

ATTENTION! Only one mode can be used at the same time: Control mode, or Pass-through mode, or Command Injection mode. If you choose one of them, TPS serial link and local RS-232 port will operate in the same mode.

Pass-through Mode

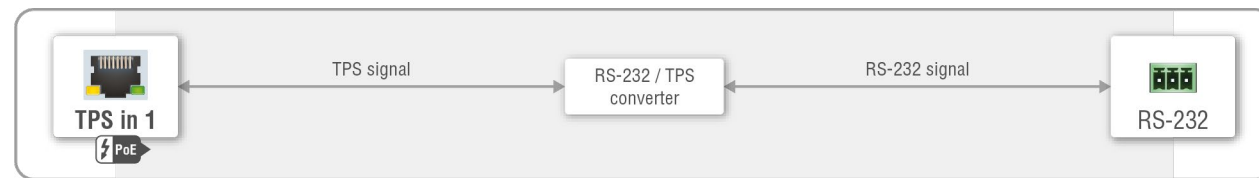

Block diagram of the serial interface in pass-through mode

In pass-through mode, the given device forwards the data that is coming from one of its ports to another same type of port. The command is not processed by the CPU. Incoming serial data is forwarded from TPS input port to local RS-232 port and vice versa inside the receiver.

Control Mode

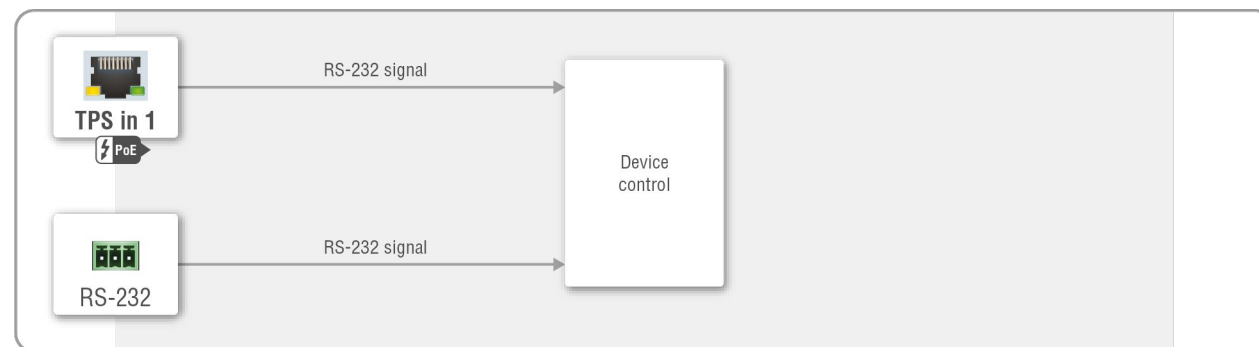

Block diagram of the serial interface in control mode

The incoming data from the given port is processed and interpreted by the CPU. The mode allows to control the receiver directly. LW2 or LW3 protocol commands are accepted – depending on the current port setting.

Command Injection Mode

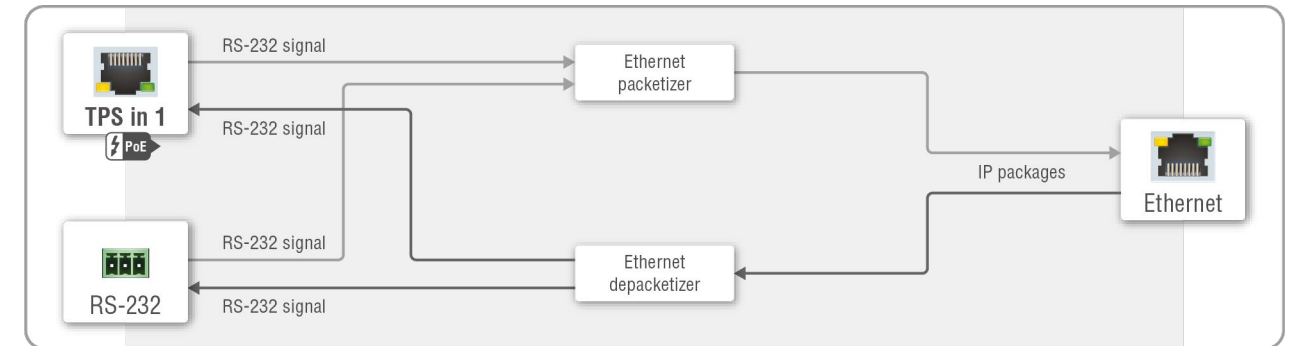

Block diagram of the serial interface in command injection mode

In this mode, the receiver works as an RS-232 bidirectional converter. The TPS signal is converted to RS-232 data and vice versa. TCP/IP port numbers are defined for the serial ports (TPS and local) for this purpose. E.g. the default Command Injection port number of the local RS-232 port is 8001. If a command is coming from the TPS interface which addresses to the port no. 8001, it will be transmitted to the Tx pin of the local RS-232 port. That works in the opposite direction of course and the method is the same on the serial interface of the TPS port as well.

RS-232 Signal Transmission – Example

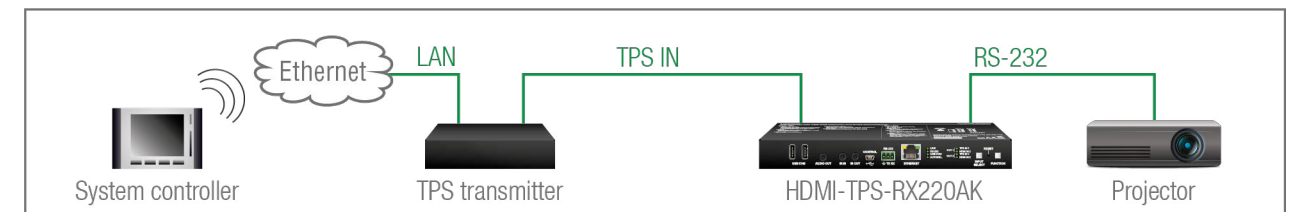

The Concept

The System controller can send commands to the receiver through the TPS transmitter and is able to remote control the projector via RS-232.

Settings

- **System controller:** wireless IP connection to the same Ethernet as the transmitter is connected to. Use a dedicated software tool (e.g. a terminal) which is suitable for sending commands via TCP/IP to a certain IP:port address.
- **Transmitter:** set the RS-232 mode to Command Injection on TPS output port. Set the further parameters (Baud rate, Data bits, etc.) in accordance with the specifications of the projector. The transmitter will transmit the RS-232 data toward the receiver.
- **Receiver:** set the RS-232 mode to Pass-through on RS-232 port.
- **Projector:** note the RS-232 port setting that is specified by the Manufacturer. Connect a suitable serial cable with the proper wiring.

4.6.2. RS-232 Recognizer

RS-232 Recognizer Example

When the HDMI-TPS-RX220AK has an active video signal, the receiver login the VC codec automatically.

Steps and Settings

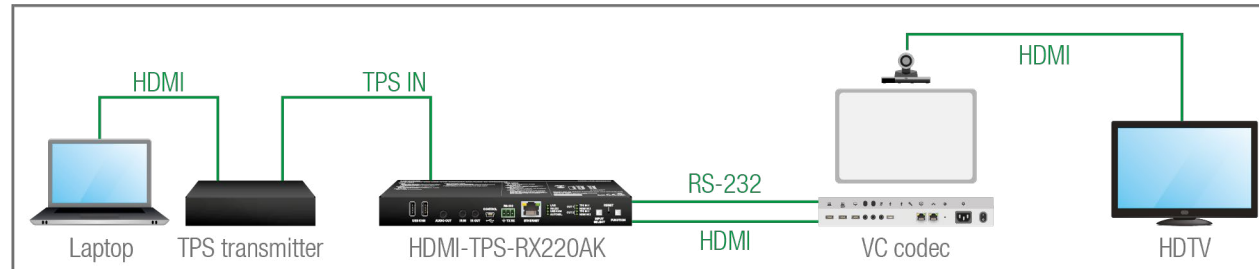

Process

When signal presents on any HDMI input, the extender sends a message: 'ping'.

Video codec sends a message: 'Login name:'.

When 'Login name:' is detected in the string, the extender sends a message: 'Admin'.

Video codec sends a message: 'Password:'.

When 'Password:' is detected in the string, the extender sends a message: 'Admin'.

Login is established, Video codec is ready to use.

Settings

This condition and the action is set in Event manager.

The serial communication is scanned continuously by the recognizer in the extender and gets the 'Login name' string.

This condition and the action is set in Event manager.

The serial communication is scanned continuously by the recognizer in the extender and gets the 'Password' string.

This condition and the action is set in Event manager.

First, configure the recognizer for the serial communication, after that, set the events in the Event Manager (for more details see the [Event Manager](#) section). The RS-232 recognizer settings has to be done with Lightware Device Controller Software (see the [Message Recognizer](#) section) or with LW3 protocol commands (see the [RS-232 Recognizer](#) section).

Settings in the Event manager

- **E1.** When the signal is present on O1 port of the HDMI-TPS-RX220AK, it sends a message 'PING' on P1 port of RS-232 to the VC codec. For more details see Message Sending via RS-232 Serial Port section.
- **E2.** Set a condition where 'Login name:' is the recognized RS-232 message. Action is sending serial message ('Admin') on the P1 port to the VC codec.
- **E3.** Set a condition where 'Password:' is the recognized RS-232 message. Action is sending serial message ('Admin') on the P1 port to the VC codec.

4.6.3. IR Interface

ATTENTION! For the complete usage attach the supplied IR emitter unit to the IR OUT and the IR detector unit to the IR IN connectors.

Technical Background

The Infrared signal transmission is similar to the serial data communication. The receiver contains dedicated IR I/O connection and also can transmit/receive IR signal via the TPS interface. The signal is in pronto HEX format in both cases.

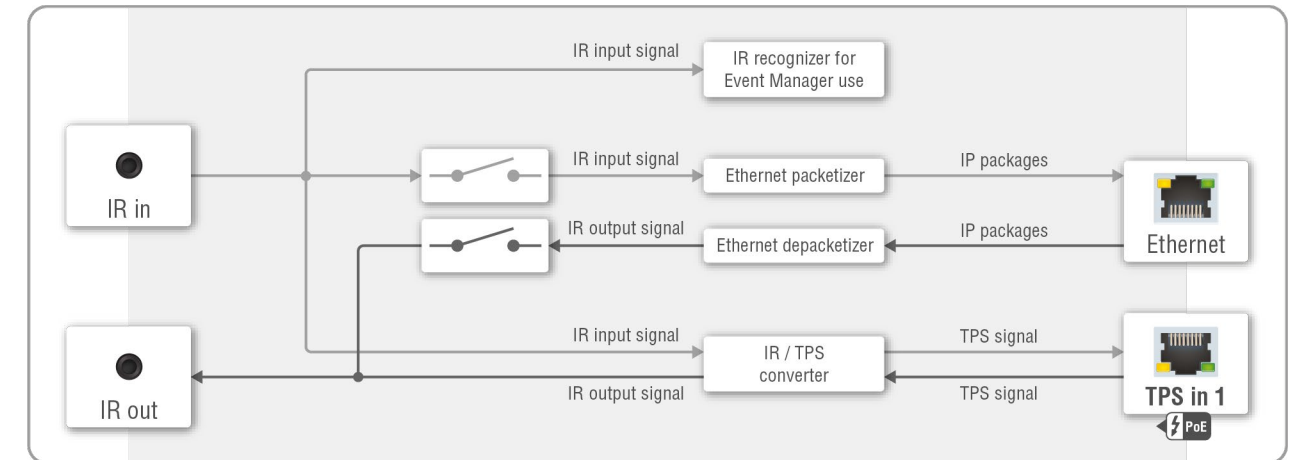

Block diagram of the IR interface

The most trivial usage of the IR interface is the transparent mode: signal received or sent on local IR ports are transmitted directly on the TPS IR link port and vice versa. Beside of this there is an IR recognizer in the device where you can assign actions in Event Manager for. The third option is the command injection mode (like at serial interface in the previous section) where you can send IR commands over LAN. Command injection mode can be turned on and off by input/output ports.

INFO: All settings are available in the LDC software, see settings in the [Infra](#) section.

INFO: The modulation of output IR signal can be turned off or on by LW3 command, see the [Enable/Disable Output Signal Modulation](#) section.

IR Signal Transmission - Example

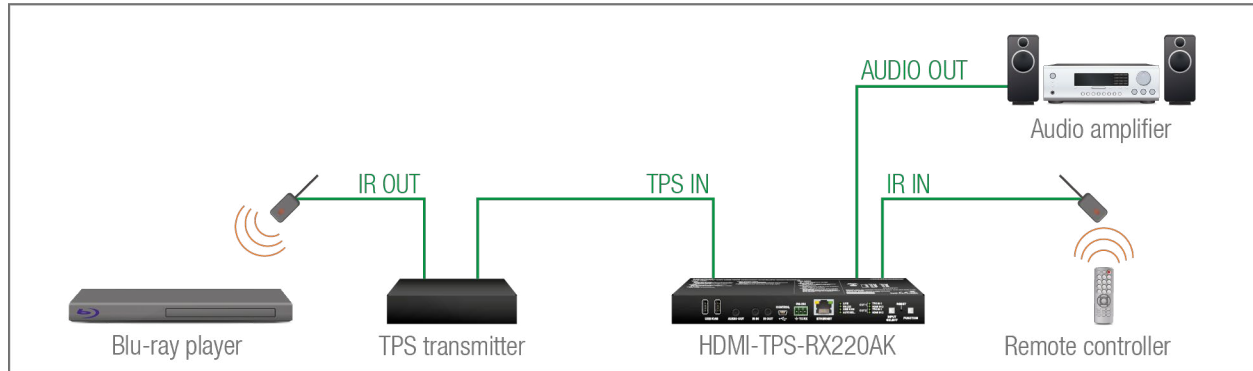

The Concept

An IR detector is attached to the Infrared input port of the Receiver and IR signals are sent by the Remote controller. The Receiver is connected to a compatible Transmitter built with IR output port via TPS line. An audio device is also connected to the audio output port of the receiver.

The following ways are available for controlling the devices:

- **Transparent mode:** IR signals are received over the local IR input port of the **Receiver** by the Remote controller. The signals transmitted further over the TPS line to the **Transmitter** which can control the **Blu-ray player** via an IR emitter.
- **Event Manager usage:** set an action in Event Manager that if the volume control buttons are pressed on the **Remote controller**, increase or decrease the volume of the analog audio port of the **Receiver**. In this case you can control the audio device via the Receiver remotely. See the details about the Event Manager settings in the [Event Manager](#) section.

Advanced IR Functionality

HDMI-TPS-RX220AK can send Little-endian pronto hex IR codes on its IR output port.

It is possible in the following ways:

- With Lightware Device Controller software (for more details see [Sending pronto hex codes \(Little-endian format\)](#) section)
- With Event Manager (for more details see [Sending pronto hex codes \(Little-endian format\)](#) and [Event Manager](#) section)
- With LW3 protocol command (for more information see the [Sending Pronto Hex Codes in Little-endian Format via IR Port](#) section)

Sending Bigger-endian pronto hex code is also available, see the [Sending Pronto Hex Codes in Big-endian Format via IR Port](#) section.

4.6.4. Consuming Electronic Control (CEC) Interface

Consumer Electronic Control (CEC) is a bi-directional communication, defined in the HDMI standard. This feature is for remote control of the source and sink devices in the A/V system.

HDMI-TPS-RX220AK is able to send and receive CEC commands, from the input ports towards the source, and from output port towards the sink. For more information about sending CEC messages, see the [CEC Controller \(LDC\)](#) and the [Sending CEC Commands \(LW3 protocol commands\)](#) sections.

ATTENTION! CEC has a dedicated pin in the HDMI connector. DVI connector does not contain this pin, so the CEC transmission brakes when HDMI-DVI connector or adapter is in the signal route.

CEC Application Example

When active signal is detected on TPS in, the transmitter sends a CEC message automatically to the HDTV to wake up.

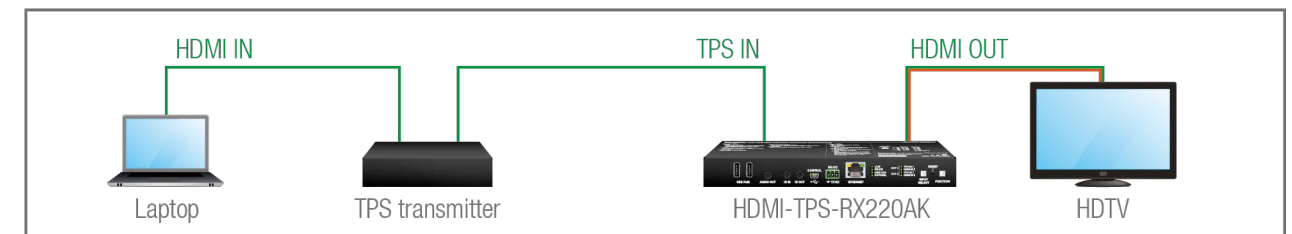

Create an event in the event manager:

- Set as a condition, that the signal is present on the output (O1),
- Set as an action then send a CEC command 'Image view on' O1 output port.

See the details about the Event Manager settings in the [Event Manager](#) section.

ATTENTION! The CEC command sending over TPS interface is working only with CEC-transparent TPS transmitters. For the details please download our Using CEC in Lightware Devices document on the <https://lightware.com/support/guides-and-white-papers> website.

4.6.5. USB Control Interface

The device can be controlled over front panel USB mini B-type connector. This interface only supports LW3 protocol. The interface can be used to establish a connection to Lightware Device Controller software.

4.6.6. Ethernet Interface

The device can be controlled over front panel Ethernet standard RJ45 connector which connected to LAN. This interface supports both LW2 and LW3 protocols.

Port Diagram

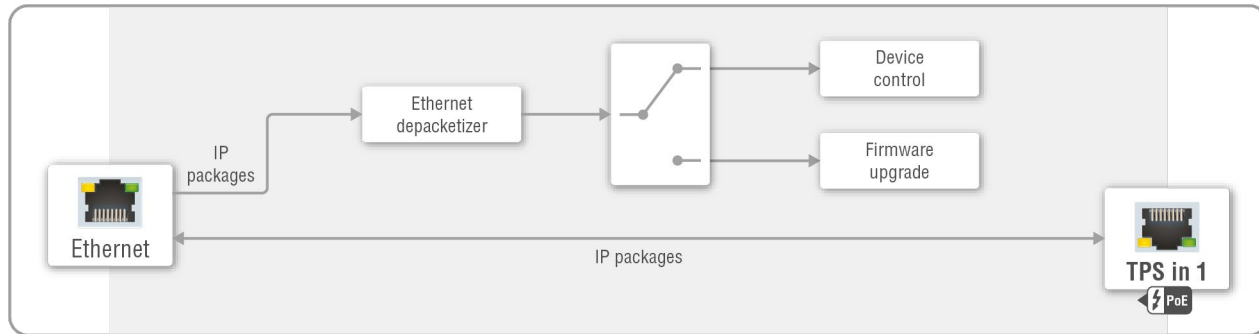

Block diagram of the Ethernet interface

The Ethernet data can be transmitted over the TPS interface and the connected transmitter device can be supervised remotely.

The interface can be used to remote control the device with Lightware Device Controller (LDC) and establish the connection to Lightware Device Updater V2 (LDU2) software and perform firmware upgrade.

4.7. Further Built-in Features

4.7.1. Automatically Launched Actions – The Event Manager

The Event Manager feature means that the device can sense changes on its ports and is able to react according to the pre-defined settings. Lightware Device Controller contains a user-friendly software tool and allows to create Events by defining a Condition and an Action.

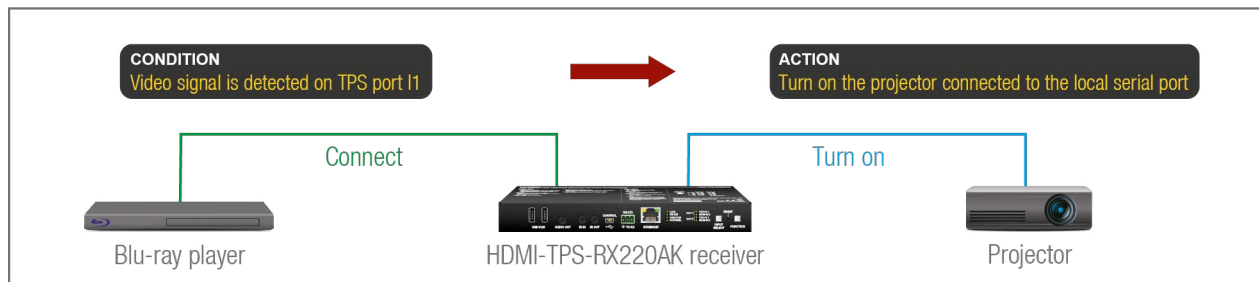

Event Manager example

See more information about the settings in the [Event Manager](#) section.

4.7.2. Receiver Cloning – Configuration Backup and Restore

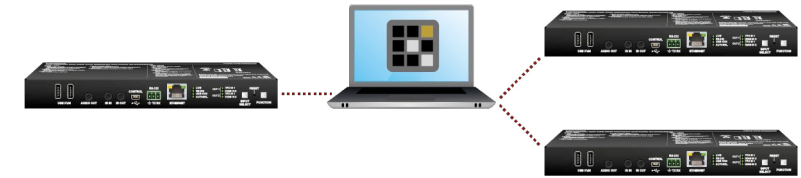

The receiver (configuration) cloning of HDMI-TPS-RX220AK is a simple method that eliminates the need to repeatedly configure certain devices to have identical (non-factory) settings. If the devices are installed in the same type of system multiple times then it is enough to set up only one device to fit the user's needs and then copy those settings to the others, thus saving time and resources.

See more information about the settings in the [Configuration Cloning \(Backup Tab\)](#) section.

4.7.3. Remote Firmware Upgrade of Connected Lightware Devices



The firmware of the Lightware TPS devices can be upgraded individually by Lightware Device Updater V2 (LDU2) software. HDMI-TPS-RX220AK contains a feature which allows having a faster and more comfortable firmware upgrade process. When the firmware of the connected extenders has to be upgraded the TPS connection is necessary towards the extenders – nothing else. The LDU2 will find the connected devices and can upgrade them.

4.8. Software Control Modes

User has more possibilities to control the device besides the front panel buttons. The following list contains the software control modes:

- **Lightware Device Controller (LDC):** you can connect to the device via our control software with using USB, RS-232 or Ethernet interfaces and control or configure the device as you wish. For the details see the [Software Control - Lightware Device Controller](#) chapter.
- **LW2 protocol commands:** you can configure the device by using the reduced command set of LW2 protocol. For more details see the [LW2 Programmer's Reference](#) chapter.
- **LW3 protocol commands:** you can configure the device by using the full-range command set of LW3 protocol. For more details see the [LW3 Programmer's Reference](#) chapter.

5

Software Control - Lightware Device Controller

The device can be controlled by a computer through RS-232, Ethernet, and USB interfaces by the Lightware Device Controller (LDC). The software can be installed on a Windows PC or macOS. The application and the User's Manual can be downloaded from www.lightware.com.

- ▶ [INSTALL AND UPGRADE](#)
- ▶ [RUNNING THE LDC](#)
- ▶ [ESTABLISHING THE CONNECTION](#)
- ▶ [CROSSPOINT MENU](#)
- ▶ [PORT PROPERTIES WINDOWS](#)
- ▶ [DIAGNOSTIC TOOLS](#)
- ▶ [EDID MENU](#)
- ▶ [CONTROL MENU](#)
- ▶ [EVENT MANAGER](#)
- ▶ [SETTINGS MENU](#)
- ▶ [THE BUILT-IN MINIWEB](#)
- ▶ [CONFIGURATION CLONING \(BACKUP TAB\)](#)
- ▶ [ADVANCED VIEW WINDOW](#)

5.1. Install and Upgrade

INFO: After the installation, the Windows and the Mac application has the same look and functionality. This type of the installer is equal with the Normal install in case of Windows and results an updateable version with the same attributes.

Installation for Windows OS

Run the installer. If the User Account Control drops a pop-up message click **Yes**.

During the installation you will be prompted to select the type of the installation: **normal** and the **snapshot** install:

Normal install	Snapshot install
Available for Windows and macOS	Available for Windows
The installer can update only this instance	Cannot be updated
Only one updateable instance can exist for all users	More than one different version can be installed for all users

Comparison of installation types

ATTENTION! Using the Normal install as the default choice is highly recommended.

Installation for macOS

Mount the DMG file with double clicking on it and drag the LDC icon over the Applications icon to copy the program into the Applications folder. If you want to copy the LDC into another location just drag the icon over the desired folder.

Upgrading of LDC

Step 1. Run the application.

The **Device Discovery** window appears automatically and the program checks the available updates on Lightware's website and opens the update window if the LDC found updates.

The current and the update version number can be seen at the top of the window and they are shown in this window even with the snapshot install.

The **Update** window can also be opened by clicking the **About icon**  and the **Update** button.

Step 2. Set the desired update setting in the **Options** section.

- If you do not want to check for the updates automatically, uncheck **the circle**, which contains the green tick.
- If you want to postpone the update, a reminder can be set with different delays from the **drop down list**.
- If the proxy settings traverse the update process, set the proper values then click the **OK** button.

Step 3. Click the **Download update** button to start the upgrading.

The updates can be checked manually by clicking the **Check now** button.

5.2. Running the LDC

The common way to start the software is double-click on the LDC icon. But the LDC can be run by command line parameters as follows:

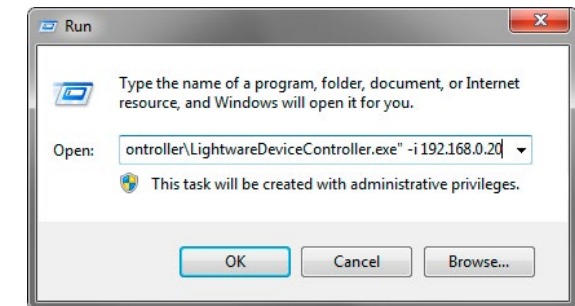

Connecting to a Device with Static IP Address

Format: LightwareDeviceController -i <IP_address>:<port>

Example: LightwareDeviceController -i 192.168.0.20:6107

The LDC is connected to a device with the indicated static IP address directly; the Device Discovery window is not displayed. When the port number is not set, the default port is used: 10001 (LW2 protocol - not supported by the UBEX extenders). For LW3 devices use the **6107** port number.

Connecting to a Device via a Serial Port

The LDC is connected to a device with the indicated COM port directly; the Device Discovery window is not displayed. If no Baud rate is set the application will detect it automatically.

Format: LightwareDeviceController -c <COM_port>:<Baud>

Example: LightwareDeviceController -c COM1:57600

5.3. Establishing the Connection

Step 1. Connect the device to a computer via Ethernet, USB or RS-232.

Step 2. Run the controller software; device discovery window appears automatically.

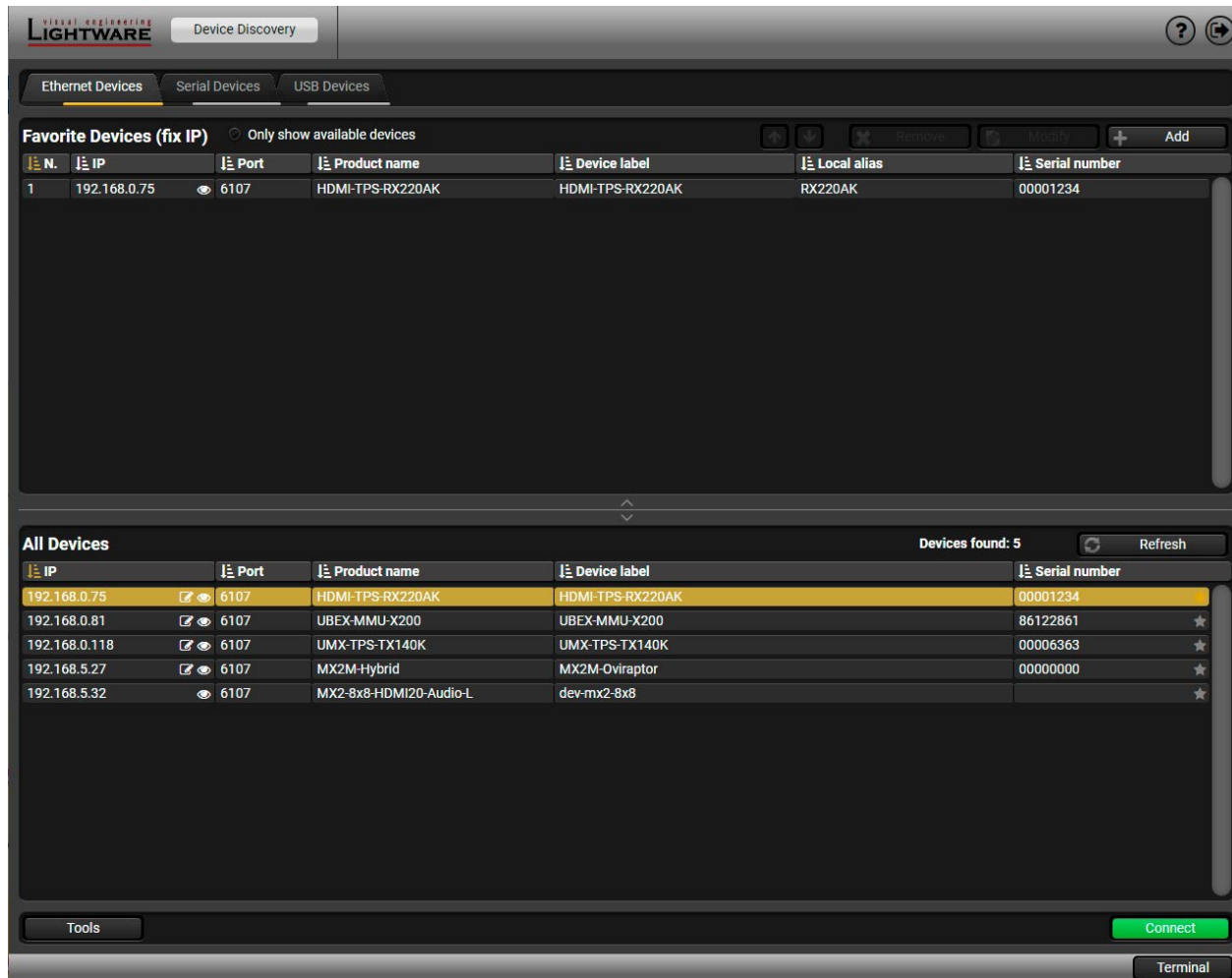

Device discovery window in LDC

Change IP Address

To modify IP address settings quickly it is not necessary to enter the device's settings/network menu, you can set them by clicking the pencil icon beside the IP address.

You can see the new settings only in this window.

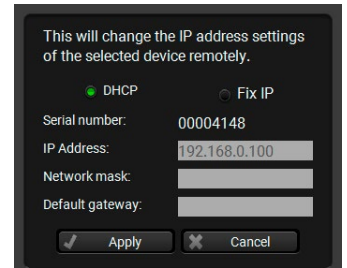

Identifying the Device

Clicking on the icon results the blinking of the device and the crosspoint status LEDs together for 10 seconds. The feature helps to identify the device itself in the rack shelf. #identifyme



Step 3. Select the unit from the discovered Ethernet devices or under Serial devices; when the device is connected through RS-232 click on the **Query** button next to the desired serial port to display the device's name and serial number. Double click on the transmitter or select the device and click on the **Connect** button.

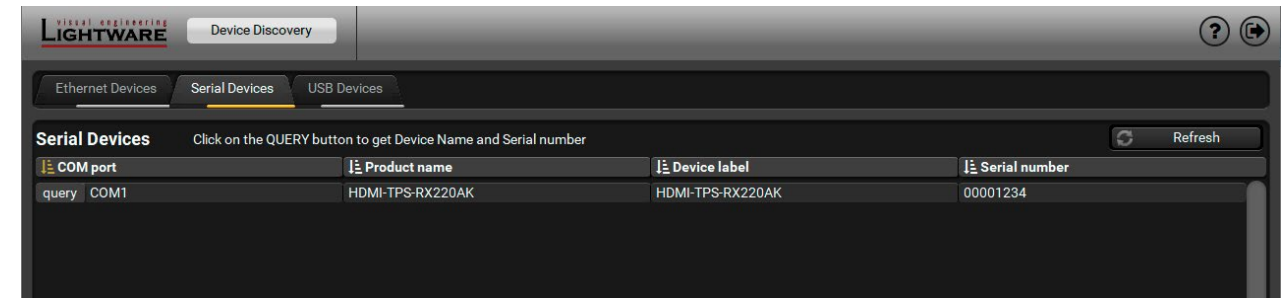

Serial devices tab in LDC

ATTENTION! Before the device is connected via the local RS-232 port, make sure that **Control mode** and **LW3 protocol** are set on the serial port.

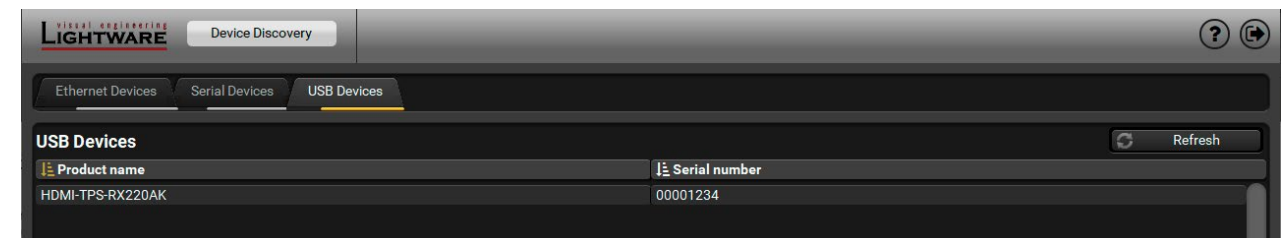

USB Devices tab in LDC

5.4. Crosspoint Menu

The receiver is built with a 2x2 video crosspoint and a 2x3 audio crosspoint which can be controlled in this menu. The section is about the available video and audio crosspoint settings. *#crosspoint #switch*

5.4.1. Video Layer



Crosspoint menu - Video layer

The two video input ports (**TPS in 1** and **HDMI in 2**) are in the horizontal tiles and the two video output ports (**HDMI out 1** and **2**) are in the vertical tiles. The **light grey tiles** means the active crosspoint setting in the crosspoint area.

See the details about the video input ports in the [Video - TPS In 1](#) and the [Video - HDMI In 2](#) sections, about the video output ports in the [Video - HDMI Out 1 and 2](#) section.

5.4.2. Audio Layer

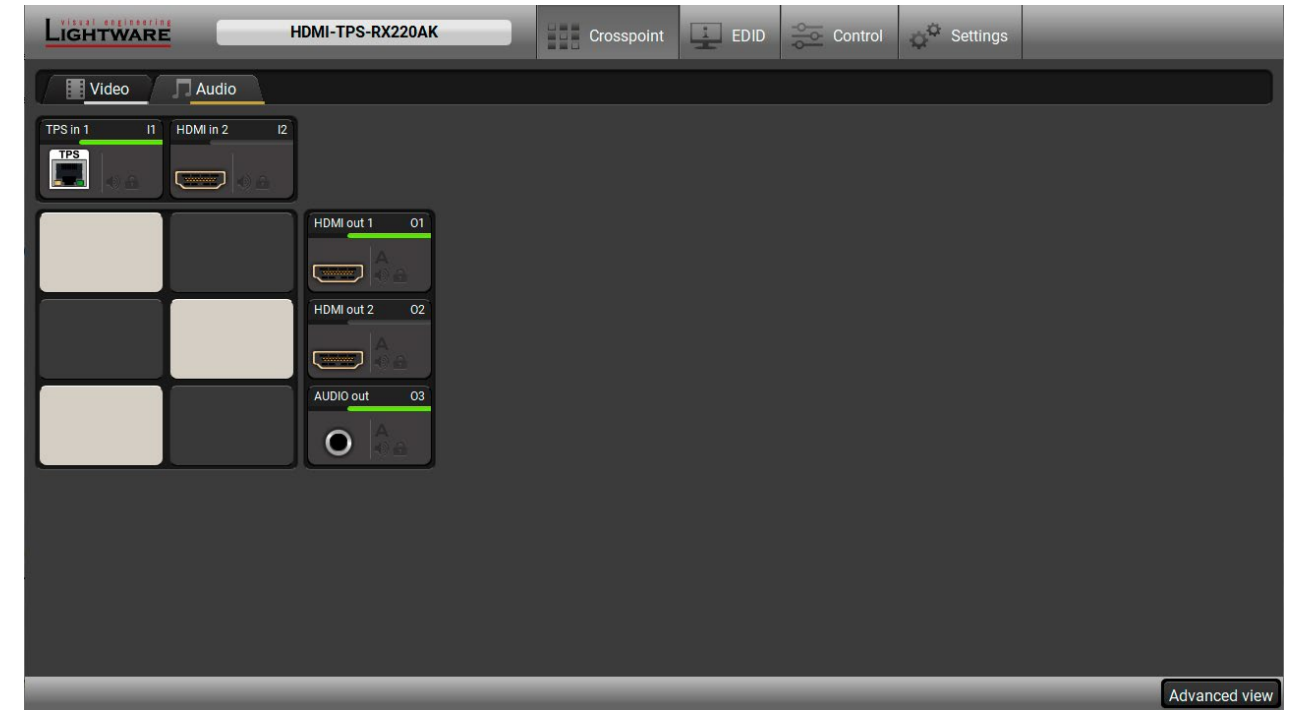

Crosspoint menu - Audio layer

The two audio input ports (**TPS in 1** and **HDMI in 2**) are in the horizontal tiles and the three audio output ports (**HDMI out 1**, **HDMI out 2** and **Analog out**) are in the vertical tiles. The **light grey tiles** means the active crosspoint setting in the crosspoint area.

See the details about the input audio ports in the [Audio - TPS In 1 and HDMI In 2](#) section, about the audio output ports in the [Audio - HDMI out 1 and 2](#) and the [Audio - Analog Audio Out](#) sections.

5.4.3. Port Tiles

The colors of the port tiles and the displayed icons represent different states and information:

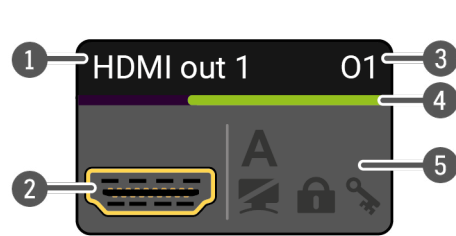

- 1 Port name
- 2 Port icon
- 3 Port number
- 4 Signal present indicator
green: present
grey: not present
- 5 State indicators

State Indicators

Following icons display different states of the port/signal:

Icon	Icon is grey	Icon is black	Icon is green
	Signal is not encrypted with HDCP	Signal is encrypted with HDCP	-
	Port is unmuted	Port is muted	-
	Port is unlocked	Port is locked	-
	Autoselect is disabled	-	Autoselect is enabled

5.5. Port Properties Windows

Clicking on a port tile opens the port properties in a pop-up window. This section is about the available audio and video related port information, settings and parameters. `#portstatus #hdcp #mute #unmute #lock #unlock #signaltype #tpsmode`

5.5.1. Video - TPS In 1

This is the TPS (HDBaseT™) video input signal of the receiver. Clicking on the port icon results opening the settings panel appearing in a pop-up window. You can check the status of the line, signal info and current emulated EDID.

Available Settings and Information:

- Port name: a unique name can be set for the port.
- **Mute/Unmute** port;
- **Lock/Unlock** the port;
- **HDCP setting** (enable / disable);
- **TPS mode** (see details in the [TPS Interface](#) section);
- Port status information;
- Signal information;
- [Cable Diagnostics](#);
- [Frame Detector](#);
- [CEC Controller](#);
- Emulated EDID information;
- Reloading [Factory Default Settings](#).

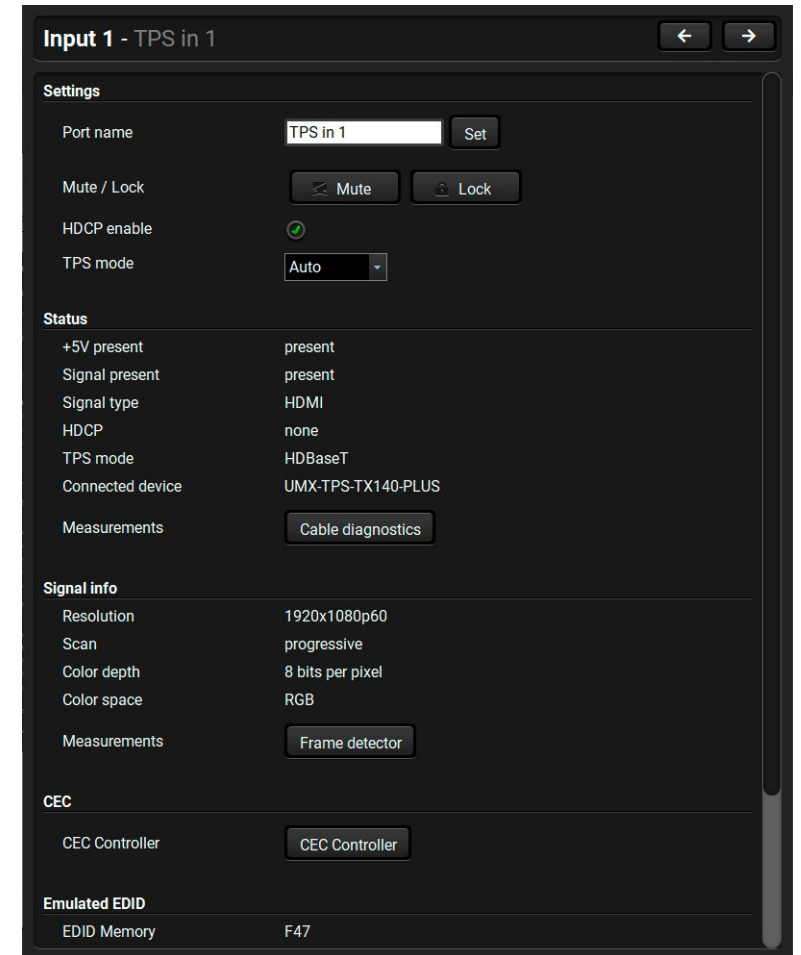

5.5.2. Video - HDMI In 2

This is the HDMI video input signal of the receiver. Clicking on the port icon results opening the settings panel appearing in a pop-up window. You can check the status of the line, signal info and current emulated EDID.

Available Settings and Information:

- Port name: a unique name can be set for the port.
- **Mute/Unmute** port;
- **Lock/Unlock** the port;
- **HDCP setting** (enable / disable);
- Port status information;
- Signal information;
- [Frame Detector](#);
- [CEC Controller](#);
- Emulated EDID information;
- Reloading [Factory](#) [Default Settings](#).

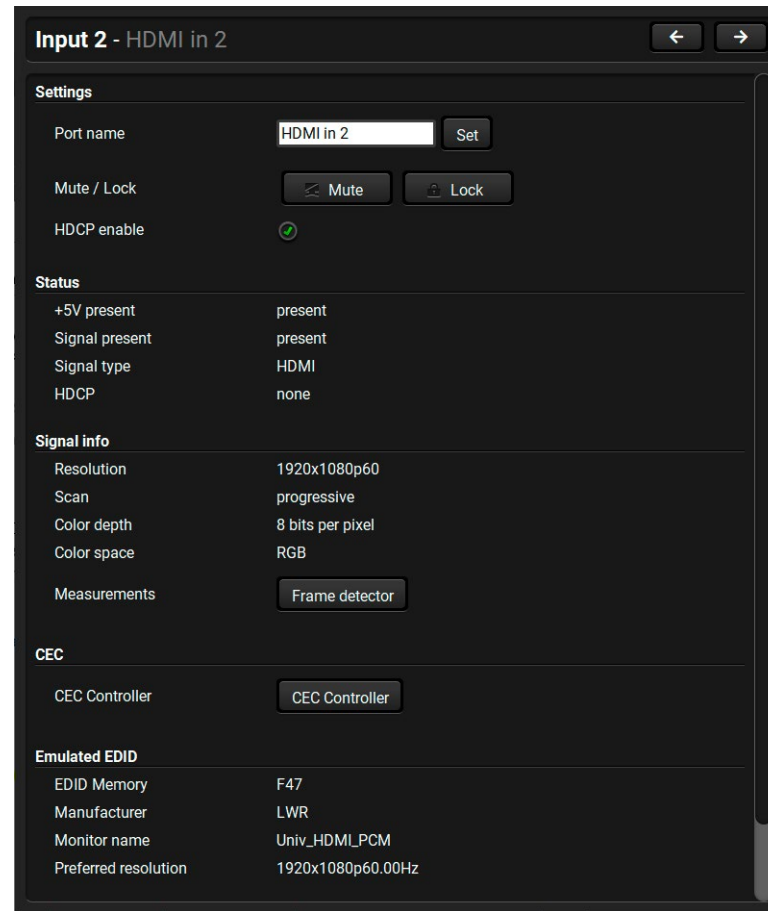

5.5.3. Video - HDMI Out 1 and 2

These are the video output signals of the receiver. Clicking on the port icon results opening the settings panel appearing in a pop-up window. You can check the status of the line, signal and display info.

Available Settings and Information:

- Port name: a unique name can be set for the port.
- **Mute/Unmute** port;
- **Lock/Unlock** the port;
- **Signal type**: Auto, DVI, or HDMI;
- **HDCP mode**: Auto or Always;
- **Power 5V mode**: Auto, Always on, or Always off;
- Port status information;
- Signal information;
- [Frame Detector](#);
- [CEC Controller](#);
- [Autoselect Feature](#);
- [No Sync Screen \(Test Pattern\)](#) function;
- Display information;
- Reloading [Factory](#) [Default Settings](#).

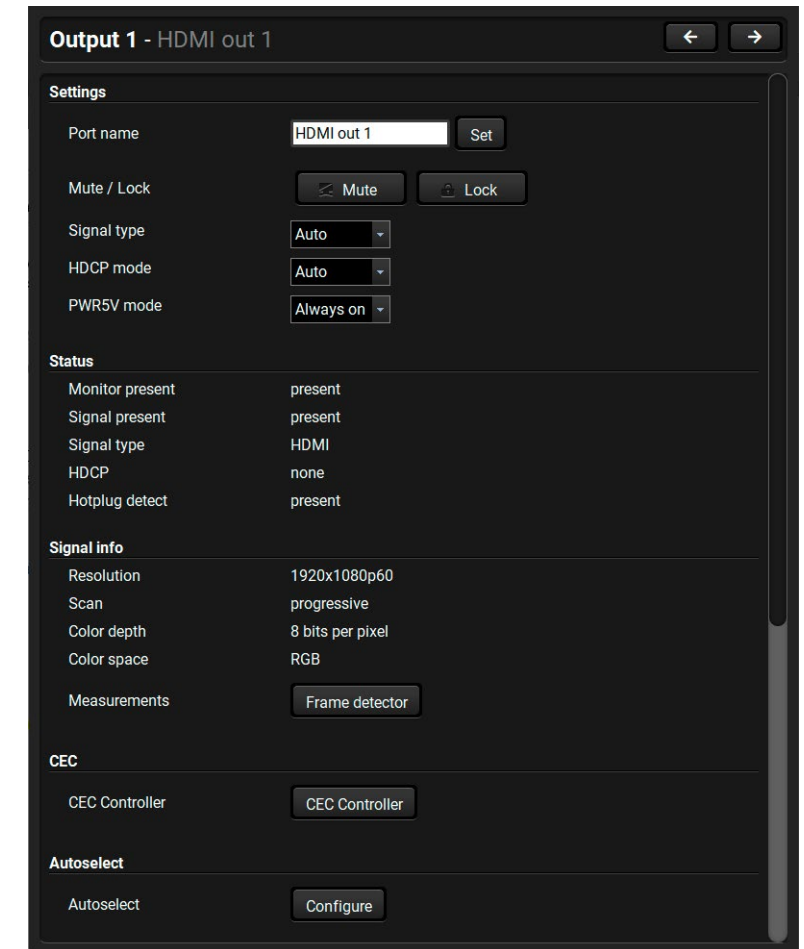

5.5.4. Audio - TPS In 1 and HDMI In 2

These are the audio input signals of the receiver. Clicking on the port icon results opening the settings panel appearing in a pop-up window. You can check the status of the line, signal and display info.

Available Settings and Information:

- Port name: a unique name can be set for the port.
- **Mute/Unmute** port;
- **Lock/Unlock** the port;
- Embedded audio information;
- Reloading [Factory Default Settings](#).

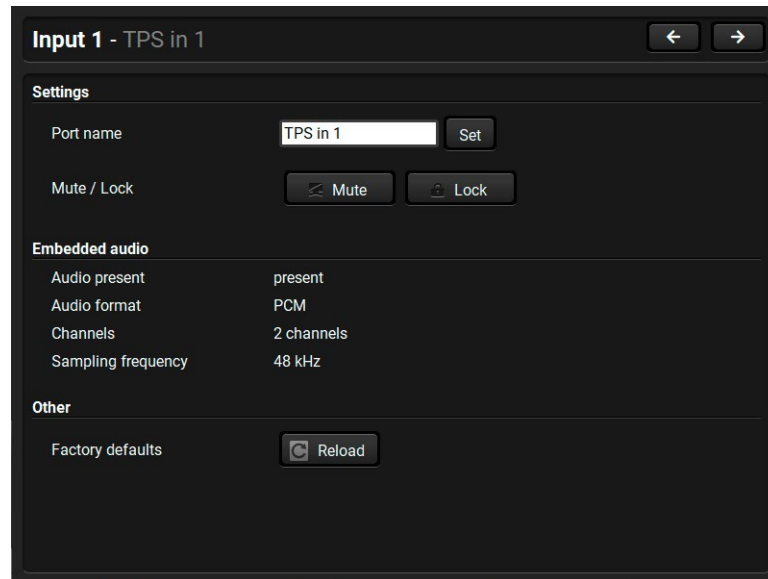

5.5.5. Audio - HDMI out 1 and 2

These are the HDMI audio output signals of the receiver. Clicking on the port icon results opening the settings panel appearing in a pop-up window. You can check the status of the line, signal and display info.

Available Settings and Information:

- Port name: a unique name can be set for the port.
- **Mute/Unmute** port;
- **Lock/Unlock** the port;
- [Autoselect Feature](#);
- Embedded audio information;
- Reloading [Factory Default Settings](#).

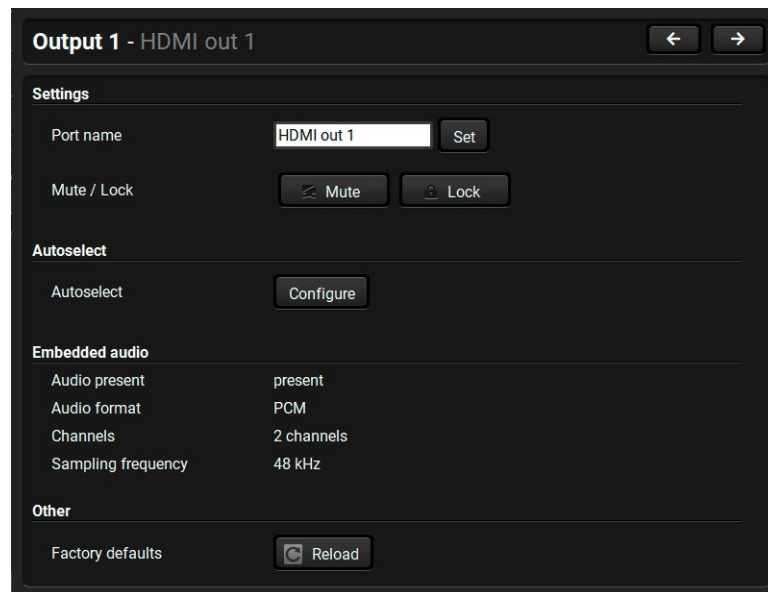

5.5.6. Audio - Analog Audio Out

This is the audio input signals of the receiver. Clicking on the port icon results opening the settings panel appearing in a pop-up window. You can check the status of the line, signal and display info.

Available Settings and Information:

- Port name: a unique name can be set for the port.
- **Mute/Unmute** port;
- **Lock/Unlock** the port;
- **Volume**: the volume of the audio signal can be adjusted from 100 to 0%, in step 1% (0 dB to -57 dB, in step 0.375 dB (default is 0 dB));
- **Balance**: the balance of the left and right channel of the signal can be adjusted from -100 to 100, in step 1 (default is 0 = center);
- [Autoselect Feature](#); `#analogaudio #volume #balance`
- Embedded audio information;
- Reloading [Factory Default Settings](#).

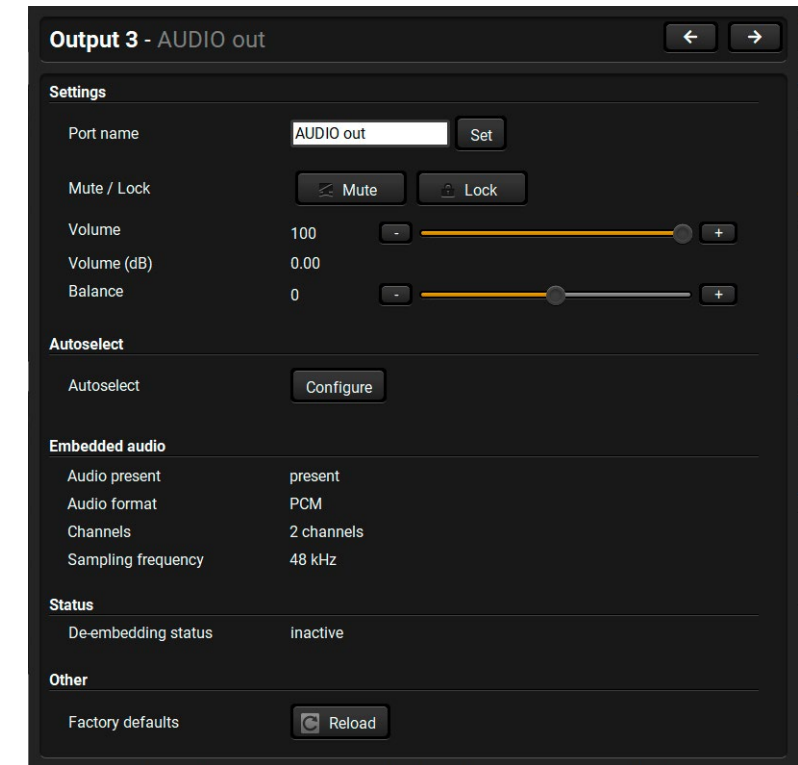

5.5.7. Autoselect Feature

Clicking on the Autoselect **Configure** button on one the output port properties window results opening the Autoselect feature configurator. Pay attention for the following settings for the proper operation of Autoselect function: `#autoselect`

- Set the Autoselect settings to be **enabled** for the desired input ports;
- Set the desired **Operation mode** (see more details about it in [The Autoselect Feature](#) section);
- Set the **priority number** in case of Priority detect operation mode.
- Always click on the **Apply** button after the changes to launch the new settings.

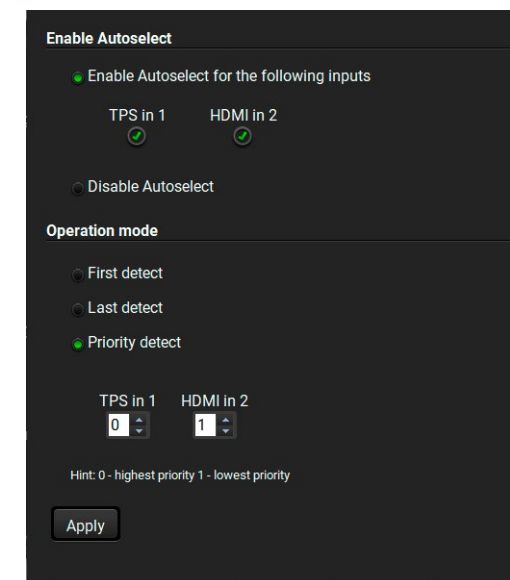

5.5.8. CEC Controller

The receiver is able to send and receive Consumer Electronic Control (CEC) commands. This feature is for remote control of the source or sink device. CEC is a bi-directional communication via HDMI cable.

ATTENTION! It can occur that the third-party device can receive, but not execute the command because it is not supported by the product. Check the accepted commands in the documentation of the device.

INFO: The first 2x2 bytes of the CEC commands contains identification data of the source and destination address. When the port is input, it is always 04 (from TV to Playback device 1.) when the port is output, it is always 40 (from Playback device 1. to TV).

The CEC panel is available on the port properties window of the **TPS / HDMI input** and **HDMI output** ports.



CEC control panel on the HDMI out port properties window

- 1 Drop-down command list** This list contains the basic CEC commands, most of them are displayed on the graphical interface, too (on the left side). Click on the **Send** button to execute sending the command.
- 2 Custom command textbox** The text field is for sending hexadecimal commands to the source. The maximum length of the message could be 30 characters (15 bytes). Click on the **Send** button to execute sending the command.
- 3 OSD string textbox** A max. 14 character-long text can be shown on the sink device. The send OSD (On-screen display) command textbox is the input field of the string. Alphanumeric characters, glyphs and space are accepted. Click on the **Send** button to execute the command.
- 4 Received Command box** Displays all the sent (in red) CEC commands and the received answers (in blue) with a timestamp.
Legend of the received message:
`< [10:33:17] ACK`
 Answer for the acknowledged command.
`< [10:35:01] NACK`
 Answer for the not acknowledged command.
`< [10:33:17] IN PROGRESS`
 The command is in progress at the moment.
`< [10:33:17] FAILED`
 Answer for other failure.
`< [10:35:40] feature_abort_<*>`
 This is the most common answer from the third-party devices when the command is delivered, but the execution is refused. The cause of the refuse stands after 'feature_abort' expression.
- 5 Clear button** Click on the **Clear** button to erase the content of the terminal window.
- 6 CEC command button panel** This panel provides the quick and easy management of CEC commands. These buttons are pre-programmed with basic functions and sends commands towards the sink. The communication is displayed in the Received Command box. For the list of the commands see [Sending a CEC Command in Text Format](#) section. Both the layout and functionality are similar to the design of a remote control.

ATTENTION! Make sure that the controlled unit is CEC-capable and this function is enabled.

#cec

5.6. Diagnostic Tools

5.6.1. Frame Detector

The ports can show detailed information about the signal like blanking intervals and active video resolution. This feature is a good troubleshooter if compatibility problems occur during system installation. To access this function, open the port properties window and click on **Frame detector** button.

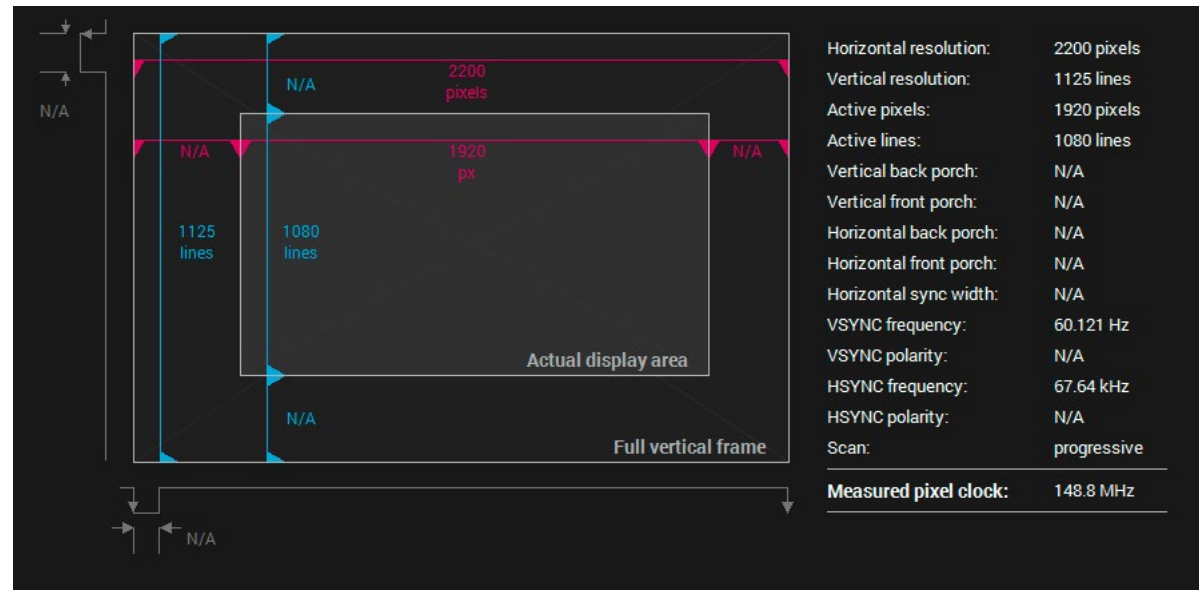

Frame detector window

Lightware's Frame Detector function works like a signal analyzer and makes possible to determine the exact video format that is present on the port, thus helps to identify many problems. E.g. actual timing parameters may differ from the expected and this may cause some displays to drop the picture.

Frame Detector measures detailed timings on the video signals just like a built-in oscilloscope, but it is much more easy to use. Actual display area shows the active video size (light grey). Dark grey area of the full frame is the blanking interval which can contain the info frames and embedded audio data for HDMI signals. Shown values are measured actually on the signal and not retrieved only from the HDMI info frames.

#diagnostic #framedetector

5.6.2. Cable Diagnostics

The cable diagnostics is a useful tool to determine any cable related issues in case of TPS connection. The estimated cable length and the quality of the link are measured periodically and the diagnostic window shows the values in real-time. If the green bars hit the first line in the middle they turn into red. It means the number of the errors – during the extension – is higher than recommended. The link might be alive but recovering of the received data is not guaranteed. #cablediagnostics

INFO: Each bar represents a differential line in the CATx cable. The inappropriate termination of the cable usually causes high error rates. Check the cable terminations or change the cable.

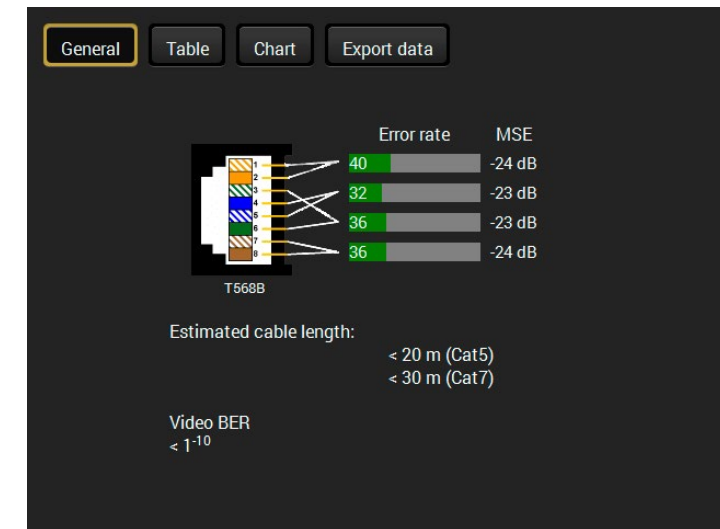

Reference Values

Value	Explanation
1 ⁻¹⁰ - 1 ⁻⁹	Excellent image quality
1 ⁻⁸	Minor error, not recognizable by eyes
1 ⁻⁷	Sometimes recognizable flash on a special test pattern
1 ⁻⁶	Small noise can be seen
1 ⁻⁵	Easy to recognize image error
1 ⁻⁴	Bad image quality

Above displayed "Video BER < 1⁻¹⁰" value means that on average there is 1 bad pixel after 10¹⁰ pixels, which means the number of the bit errors is about 1 pixel in every 80 seconds.

INFO: You can find more details about maximum twisted pair cable distances in the [Maximum Extension Distances](#) section.

Table and Chart Views

Cable diagnostics can be displayed in advanced modes as well. Two ways are available: **table view** and **chart view**. Data can be exported to a file on clicking on the **Export data** button.

Date	MSE #1	MSE #2	MSE #3	MSE #4	Error rate #1	Error rate #2	Error rate #3	Error rate #4	Cable length
2016-11-12 09:57:23	-24	-22	-22	-22	28	52	32	34	< 20
2016-11-12 09:57:24	-24	-22	-22	-22	28	52	32	34	< 20
2016-11-12 09:57:25	-24	-22	-23	-23	28	46	30	34	< 20
2016-11-12 09:57:26	-24	-22	-22	-22	26	44	30	36	< 20
2016-11-12 09:57:27	-24	-22	-22	-22	26	44	30	36	< 20
2016-11-12 09:57:28	-24	-22	-23	-22	26	46	32	38	< 20
2016-11-12 09:57:29	-24	-22	-23	-22	26	46	32	38	< 20
2016-11-12 09:57:30	-24	-22	-23	-22	26	46	32	38	< 20

Table view of cable diagnostics

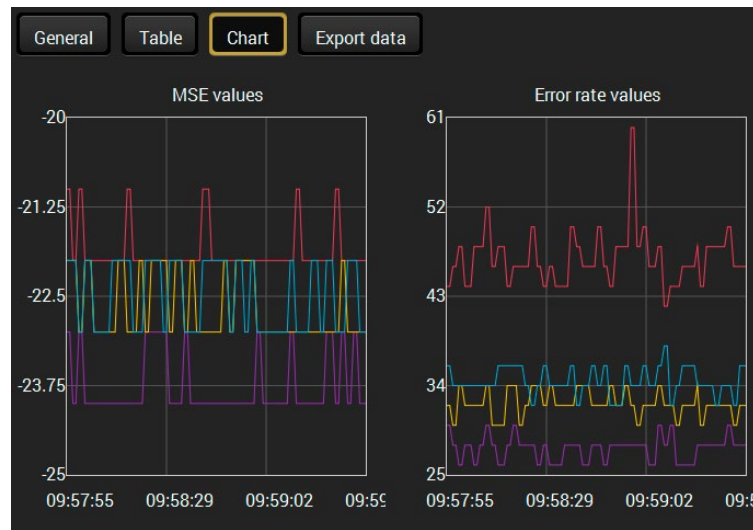

Chart view of cable diagnostics

5.6.3. No Sync Screen (Test Pattern)

The No sync screen feature generates an image which can be displayed when there is no incoming signal on the port. The following settings can be set for the Test Pattern function:

Test pattern

Mode: Off

Clock source: 480p

Pattern: Bar

Mode

- **On:** the video output port always transmits the test pattern.
- **No signal:** the video output port transmits the test pattern if there is no incoming signal on the selected input port.
- **Off:** the test pattern function is disabled, the video output port transmits the video signal of the selected input port.

Clock Source

- 480p
- 576p
- Original video signal

Pattern

- Red
- Green
- Blue
- Black
- White
- Ramp
- Chess
- Bar
- Cycle - it means the previous eight patterns are repeated continuously.

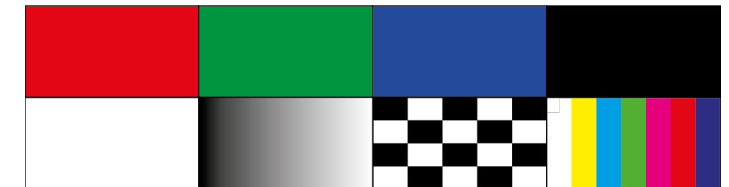

#nosyncscreen #testpattern





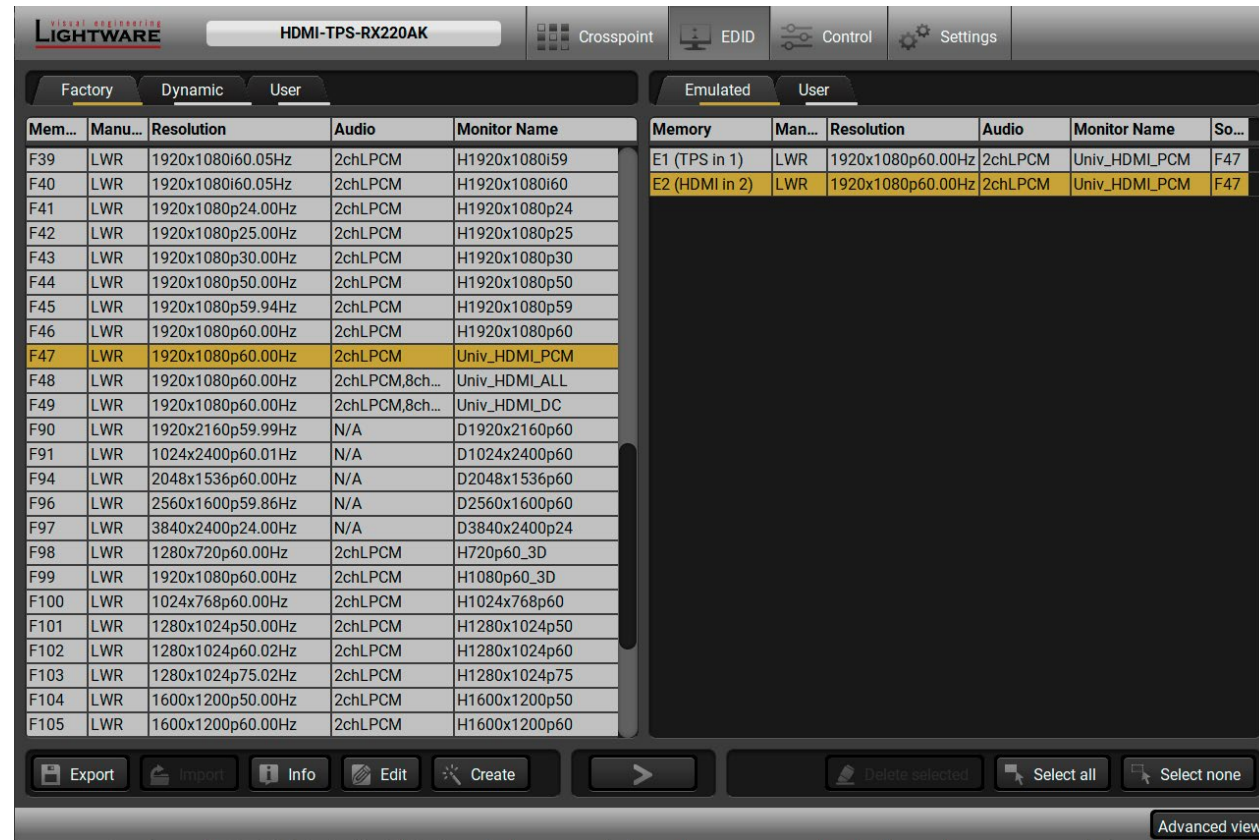

5.7. EDID Menu

Advanced EDID Management can be accessed by selecting the EDID menu. There are two panels: left one contains Source EDIDs, right one contains Destination places where the EDIDs can be emulated or copied.



EDID menu

Control Buttons

-  Export Exporting an EDID (save to a file)
-  Import Importing an EDID (load from a file)
-  Info Display EDID Summary window
-  Edit Opening Advanced EDID Editor with the selected EDID
-  Create Opening Easy EDID Creator
-  > Transfer button: executing EDID emulation or copying
-  Delete selected Deleting EDID (from User memory)
-  Select all Selecting all memory places in the right panel
-  Select none Selecting none of the memory places in the right panel

5.7.1. EDID Operations

Changing Emulated EDID

- Step 1.** Choose the desired **EDID list** on the source panel and select an **EDID**. 
- Step 2.** Press the **Emulated** button on the top of the Destination panel.
- Step 3.** Select the desired **port** on the right panel (one or more ports can be selected); the EDID(s) will be highlighted with a yellow cursor.
- Step 4.** Press the **Transfer** button to change the emulated EDID.

Learning an EDID

The process is the same as changing the emulated EDID; the only difference is the Destination panel: press the **User** button. Thus, one or more EDIDs can be copied into the user memory either from the factory memory or from a connected sink (Dynamic).

Exporting an EDID

- Source EDID can be downloaded as a file (*.bin, *.dat or *.edid) to the computer.
- Step 1.** Select the desired **EDID** from the Source panel (line will be highlighted with yellow).
 - Step 2.** Press the **Export** button to open the dialog box and save the file to the computer.



Importing an EDID

- Previously saved EDID (*.bin, *.dat or *.edid file) can be uploaded to the user memory:
- Step 1.** Press the **User** button on the top of the Source panel and select a **memory** slot.
 - Step 2.** Press the **Import** button below the Source panel.
 - Step 3.** Browse the file in the opening window then press the **Open** button. Browsed EDID is imported into the selected User memory.



ATTENTION! The imported EDID overwrites the selected memory place even if it is not empty.

Deleting EDID(s)

- The EDID(s) from User memory can be deleted as follows:
- Step 1.** Press **User** button on the top of the Destination panel.
 - Step 2.** Select the desired **memory** slot(s); one or more can be selected (“Select All” and “Select None” buttons can be used). The EDID(s) will be highlighted with yellow.
 - Step 3.** Press the **Delete selected** button to delete the EDID(s).



#edid

5.7.2. EDID Summary Window

Select an EDID from Source panel and press **Info** button to display EDID summary.



General

- EDID version: 1
- EDID revision: 3
- Manufacturer ID: SAM (Samsung Electric Company)
- Product ID: 8E09
- Monitor serial number: Not present
- Year of manufacture: 2012
- Week of manufacture: 9
- Signal interface: Digital
- Separate Sync H&V: -
- Composite sync on H: -
- Sync on green: -
- Serration on VS: -
- Color depth: Undefined
- Interface standard: Not defined
- Color spaces: RGB 4:4:4 & YCrCb 4:4:4
- Aspect ratio: 0.56
- Display size: 52 cm X 29 cm

EDID summary window

5.7.3. Editing an EDID

Select an EDID from Source panel and press **Edit** button to display Advanced EDID Editor window. The editor can read and write all descriptors, which are defined in the standards, including the additional CEA extensions. Any EDID from the device's memory or a saved EDID file can be loaded into the editor. The software resolves the raw EDID and displays it as readable information to the user. All descriptors can be edited, and saved in an EDID file, or uploaded to the User memory. For more details about EDID Editor please visit our website (<https://lightware.com/support/guides-and-white-papers>) and download EDID Editor user's manual.



Basic EDID

- Vendor / Product Information
- Display Parameters
- Power Management and Features
- Gamma / Color and Established Timings
- Standard Timings
- Preferred Timing Mode
- 2nd Descriptor Field
- 3rd Descriptor Field
- 4th Descriptor Field
- CEA Extension
- General
- Video Data
- Audio Data
- Speaker Allocation Data
- HDMI
- Colorimetry
- Detailed Timing Descriptor #1
- Detailed Timing Descriptor #2
- Detailed Timing Descriptor #3
- Detailed Timing Descriptor #4
- Detailed Timing Descriptor #5
- Detailed Timing Descriptor #6
- Save EDID

EDID Byte Editor

	0	1	2	3	4	5	6	7	8	9
0	00	FF	FF	FF	FF	FF	FF	00	4C	2D
10	8E	09	00	00	00	00	09	16	01	03
20	80	34	1D	78	0A	7D	D1	A4	56	50
30	A1	28	0F	50	54	BD	EF	80	71	4F
40	81	C0	81	00	81	80	95	00	A9	C0
50	B3	00	01	01	02	3A	80	18	71	38
60	2D	40	58	2C	45	00	09	25	21	00
70	00	1E	66	21	56	AA	51	00	1E	30
80	46	8F	33	00	09	25	21	00	00	1E
90	00	00	00	FD	00	18	4B	1A	51	17
100	00	0A	20	20	20	20	20	20	00	00
110	00	FC	00	54	32	34	42	33	30	31
120	0A	20	20	20	20	20	01	6C		

EDID Editor window

5.7.4. Creating an EDID - Easy EDID Creator

Since above mentioned Advanced EDID Editor needs more complex knowledge about EDID, Lightware introduced a wizard-like interface for fast and easy EDID creation. With Easy EDID Creator it is possible to create custom EDIDs in four simple steps. By clicking on the **Create** button below Source panel, **Easy EDID Creator** is opened in a new window.

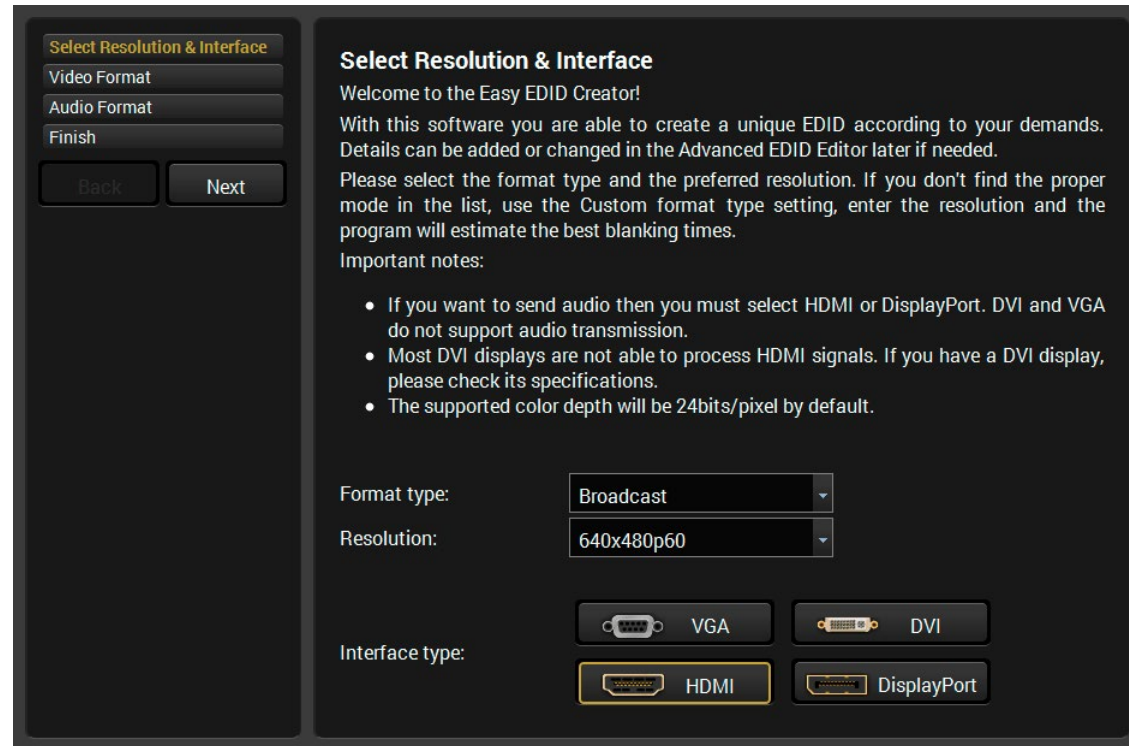

EDID Creator window

5.8. Control Menu

5.8.1. RS-232

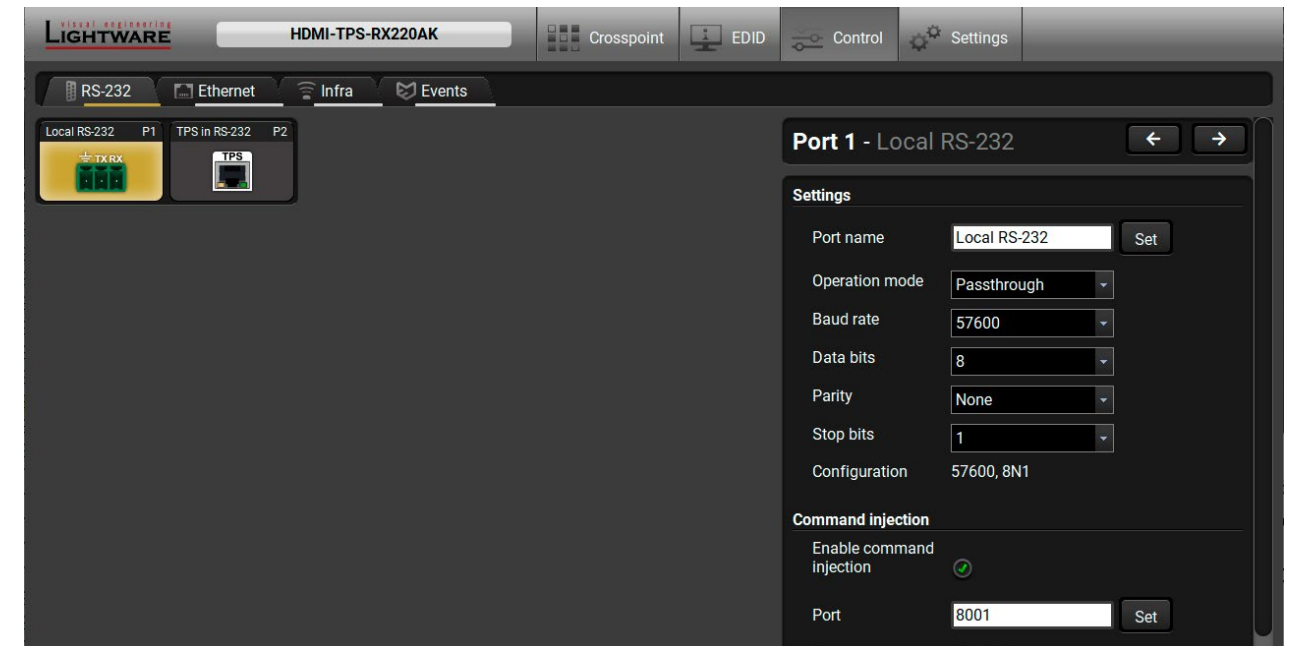

RS-232 tab in Control menu

The following settings and functions are available (both on local and TPS serial ports):

- **Operation mode:** Pass-through, Control, or Command Injection (for more details about serial interface modes see the [Serial Interface](#) section);
- **Baud rate:** 4800, 7200, 9600, 14400, 19200, 38400, 57600, 115200;
- **Data bits:** 8 or 9;
- **Parity:** None, Odd, or Even;
- **Stop bits:** 1, 1.5, or 2;
- **Command injection:** enable or disable;
- **Command injection port number;**
- **Control protocol:** LW2 or LW3;
- **Message sending** via serial port;
- Reloading [Factory Default Settings](#).

ATTENTION! Operation mode of the local and TPS serial ports can be set together only. It means if you set the local RS-232 port to Control mode, the TPS serial link will be changed to Control mode either automatically.

ATTENTION! If the receiver is connected to a TPS2 output board of a matrix frame, the RS-232 configuration settings (baud rate, data bits, e.t.c.) will not be changeable on the receiver side.

#rs232 #rs-232 #serial #commandinjection #protocol #message

Message Recognizer

The receiver can analyze and store the received serial data. For more information see the [RS-232 Recognizer](#) section.

Put a tick to **Enable message recognizer on this port** to switch the recognizer on.

Delimiter sequence text box is for set the delimiter string in hex format. When this string is detected in the incoming serial data, the device saves the RS-232 message data from the first bit, until the delimiter (or the data between the two delimiters).

INFO: 0D0A is the factory default value, this is the hexadecimal code of Carriage Return and Line Feed. LW3 protocol commands ended with this formula, so the default value support the recognition of the LW3 commands and the stored changes automatically.

If the **Timeout** is enabled and set, the received data is saved when the timeout is elapsed after the last received message.

In **Received messages** box shows the last received and stored message in Text (RECOGNIZER.Rx), Hex (RECOGNIZER.RxHex), and Hash (RECOGNIZER.Hash) format. The Hex and Hash contains the delimiter.

Press the **Clear** button to erase this storage.

Clicking on **Reload** restores the factory default values of the recognizer.

ATTENTION! The Message recognizer settings are mirrored on the Local and TPS in serial ports.

INFO: Message recognizer operates independently of the RS-232 mode.

#recognizer #rs232recognizer #rs-232recognizer

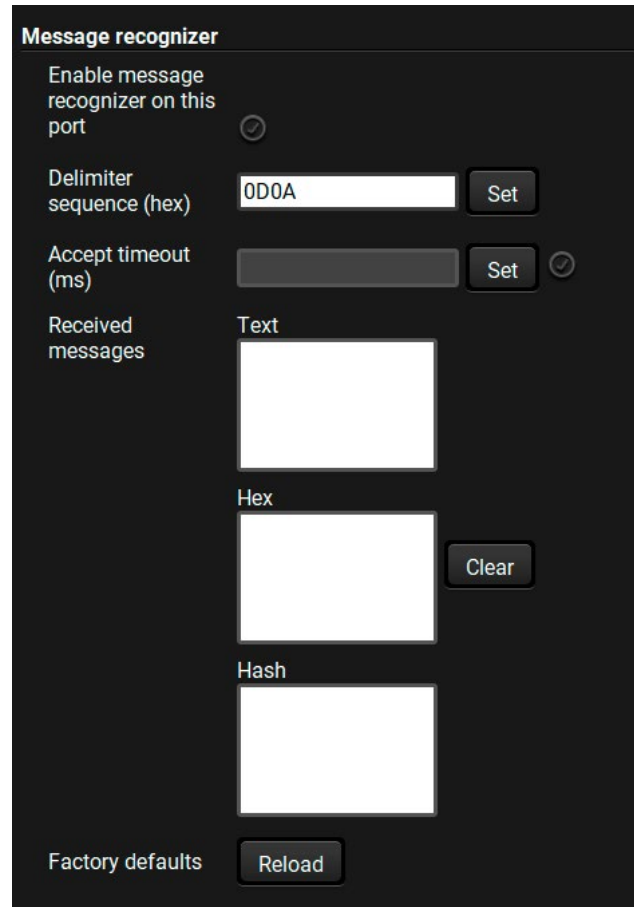

Configuration Example for the Message Recognizer

The detailed description below shows how to configure the message recognizer in [RS-232 Recognizer Example](#).

When the HDMI-TPS-RX220AK has an active video signal, the switcher login the VC codec automatically. The signal presence triggers a bi-directional communication with the VC codec via RS-232:

Step 1. Turn on the recognizer: Enable it on the P1 serial port.

Step 2. Set the delimiter (in hex format). In this case, the delimiter character is ':', which is '3a' in hex format. When the delimiter string is detected in the incoming serial data, the serial message is stored in string (in Rx and ActiveRx property), hex (in RxHex and ActiveHex property) and hash (in Hash and ActiveHash property) format. These stored content can be set as a condition in the event manager.

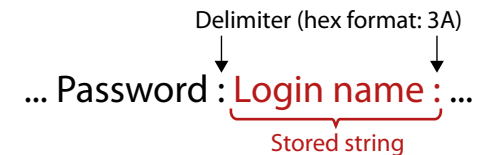

INFO: The stored content is the incoming data which arrives **before** the delimiter or **between** the two delimiters.

Step 3. Set the Active timeout 100. This property is responsible for erasing the temporary storage (ActiveRx, ActiveRxHex, ActiveHash) after the elapsing time. In the below example, it can be seen how does the recognizer properties change during the communication:

▶ HDMI-TPS-RX220AK: PING

Rx	RxHex	Hash	ActiveRx	ActiveRxHex	ActiveHash

◀ VC codec: Login:

Rx	RxHex	Hash	ActiveRx	ActiveRxHex	ActiveHash
Login:	4C6F67696E3A	2D8A5E38	Login:	4C6F67696E3A	2D8A5E38

▶ HDMI-TPS-RX220AK: Admin

Active timeout is elapsed, so the values of the Active- prefixed properties are deleted.

Rx	RxHex	Hash	ActiveRx	ActiveRxHex	ActiveHash
Login:	4C6F67696E3A	2D8A5E38			

◀ VC codec: Password:

Rx	RxHex	Hash	ActiveRx	ActiveRxHex	ActiveHash
Password:	50617373776F72643A	79059B26	Password:	50617373776F72643A	79059B26

▶ HDMI-TPS-RX220AK: Admin

Active timeout is elapsed, so the values of the Active- prefixed properties are deleted.

Rx	RxHex	Hash	ActiveRx	ActiveRxHex	ActiveHash
Password:	50617373776F72643A	79059B26			

5.8.2. Ethernet

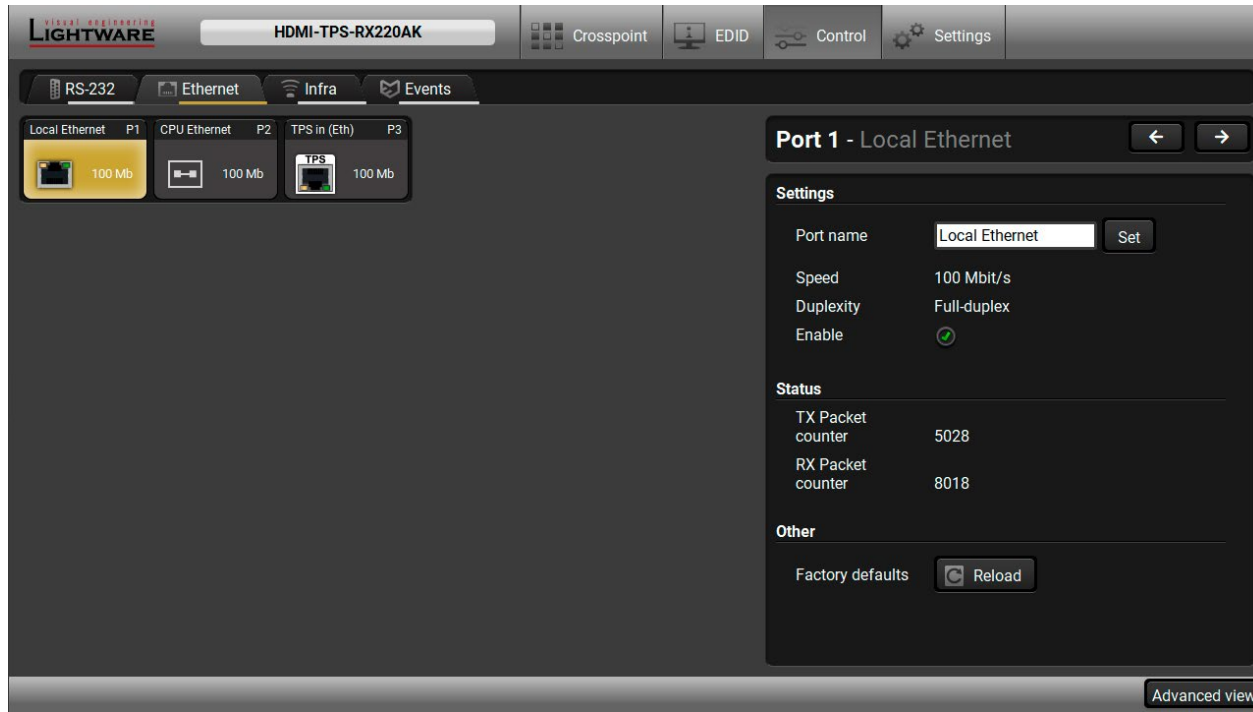

Ethernet tab in Control menu

Three ports are displayed in the Ethernet settings: Local, CPU and TPS. You can check the status of the Ethernet line by each ports: the speed and the duplexity of the connection.

The following settings are available for each ports:

- Enable / disable the port; *
- Reloading factory defaults.

* CPU Ethernet port cannot be disabled.

5.8.3. Infra

ATTENTION! The device has no built-in Infrared receiver and transmitter. For the complete usage attach an IR emitter unit to the IR OUT and an IR detector unit to the IR IN connectors.

Infrared (IR) receiver and transmitter options can be found on this tab. There are three submenus are available under it: **IR codes**, **Ports**, and **Clear all IR codes**.

IR Codes

User can set the name of the IR code, the fingerprint (hash), and the repeat timeout in ms, as well as actions can be ordered to each IR codes.

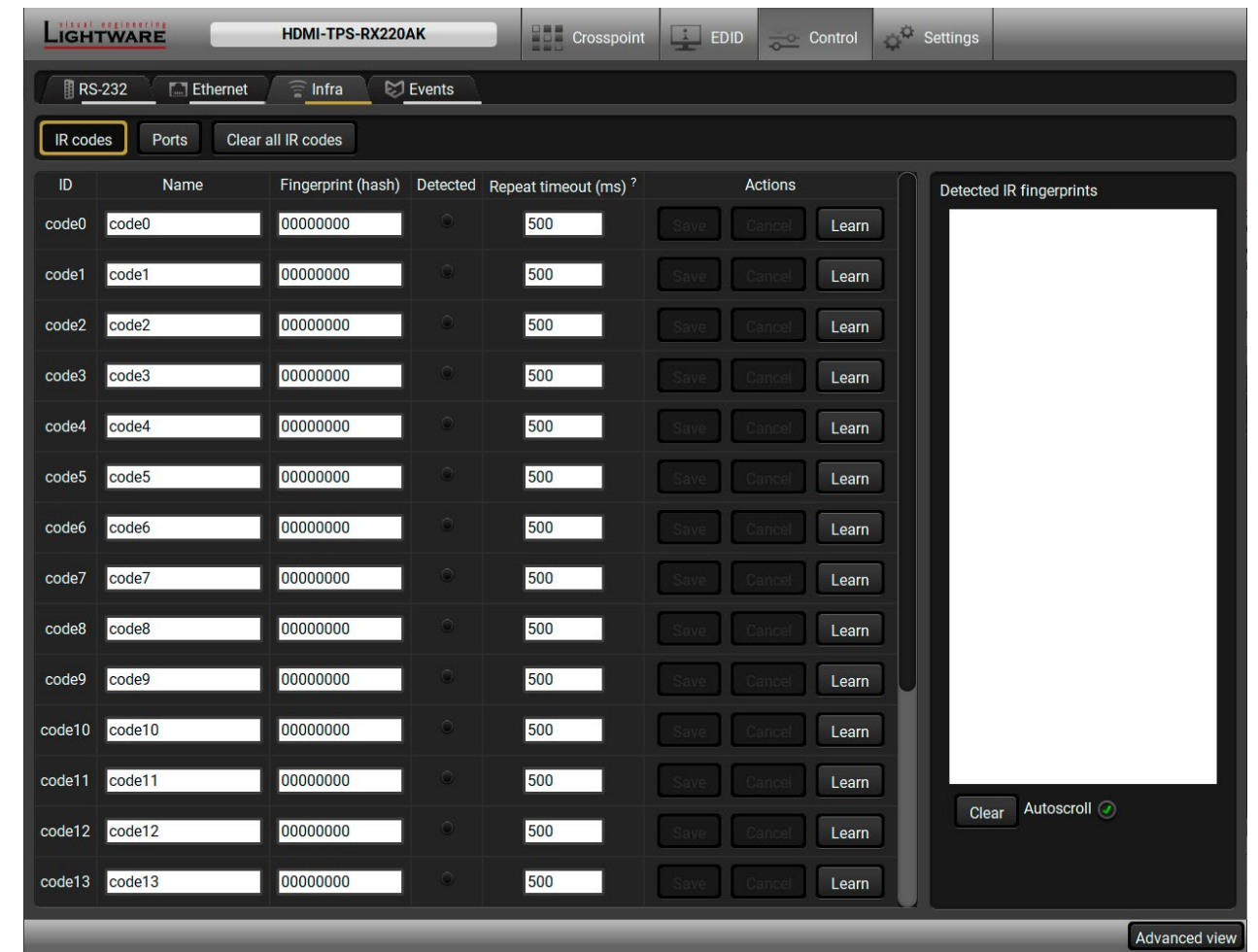

IR codes window in Control menu

#infra #infrared #message

Description	Function
ID	Code number.
Name	You can give an unique name for the desired code.
Fingerprint (hash)	Fingerprint code in pronto hexa format.
Detected	Indicator gives feedback about the given IR code is detected currently.
Repeat timeout (ms)	You can set a timeout to avoid the involuntary code recurrence.
Actions	Action buttons for the desired IR code: Save: saving the fingerprint. Cancel: canceling the fingerprint. Learn: learning the detected IR code.
Detected IR fingerprints	You can check the detected IR codes in this panel. Pushing Clear button deleting all current fingerprints and switch on or off the automatic scrolling with the Autoscroll pipe.

20 fingerprints can be stored in the device at the same time. Each of them can be ordered to an action in Event Manager. For more details about events see [Event Manager](#) section.

Learning IR Codes

- Step 1.** Connect the IR detector unit to the IR IN port of the receiver.
- Step 2.** Click on the **Learn** button.
- Step 3.** Turn the remote controller to the IR detector. A pop-up window appears in LDC - press your remote button to learn.
- Step 4.** Once the code is received, a new window pops up in LDC - learning completed. Click **OK** to continue.
- Step 5.** Optionally type a unique name for the code in the **Name** text box. The default name is code#, e.g. code0.

Ports Section

The user can set the name and command injection port to each sources and destinations. For more details about IR interface see the [IR Interface](#) section.

The following settings are also available:

- Port name;
- Enable / disable the port;
- Port number;
- Enable / disable command injection;
- Message sending function (little-endian pronto hex code). For more details see the next section;
- Reloading [Factory Default Settings](#).

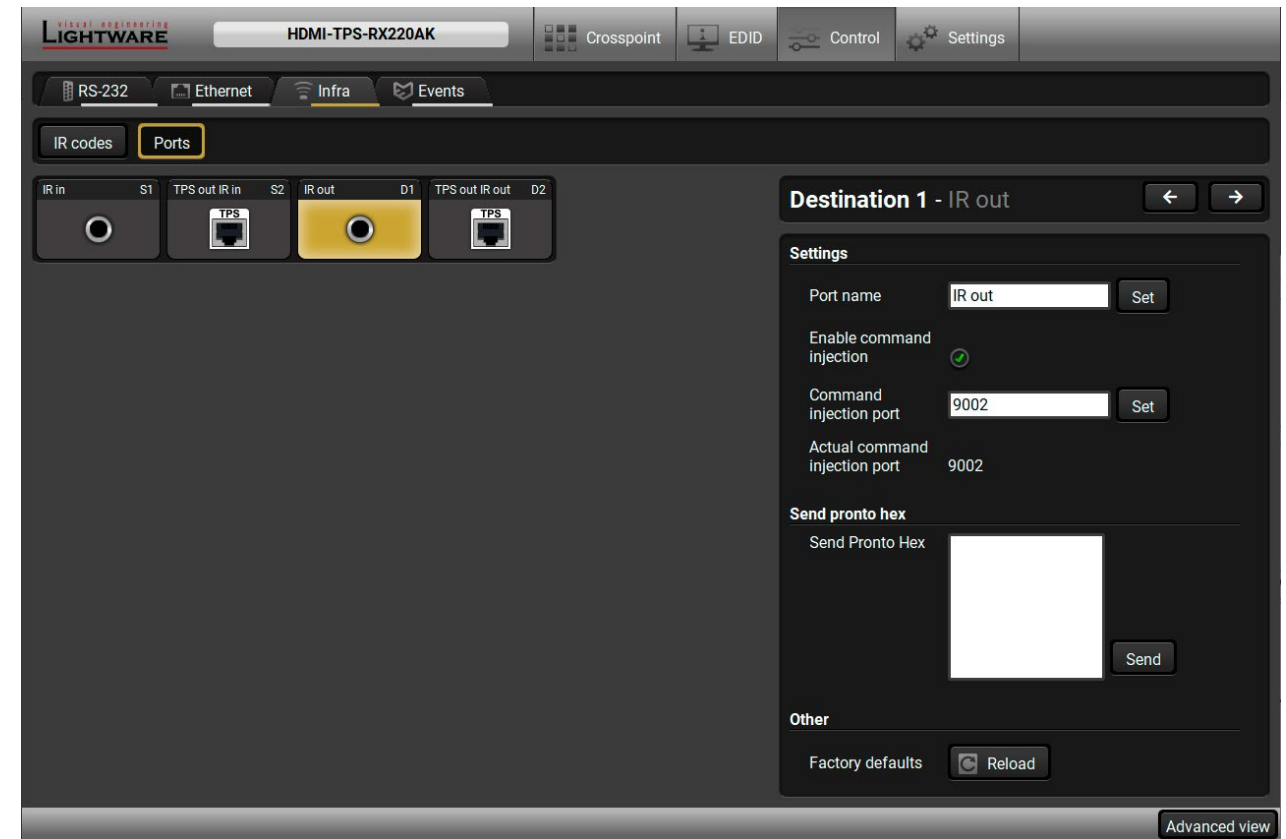

Infra tab - Ports window

Sending pronto hex codes (Little-endian format)

Copy the raw, little endian-format IR code into the **Send Pronto Hex** entry field and click the **Send** button.

The maximum length of the code can be 765 characters (765 bytes). For more details about the accepted IR code formats, see [Sending Pronto Hex Codes in Little-endian Format via IR Port](#) section.

This entry field does not store the code. The code can be saved into the action in the event manager with the following parameters: **Category:** Infra; **Expression:** Send pronto hex; **Port:** D1; **Pronto hex:** <custom_code>

In the Event Manager, the maximum length of the code can be 184 characters (184 bytes).

INFO: Sending bigger endian-format code is available with LW3 protocol command, see [Sending Pronto Hex Codes in Big-endian Format via IR Port](#) section.

Clear all IR codes

Clicking on the button results deleting all stored IR fingerprints.

5.9. Event Manager

The feature means that the device can sense changes on its ports and able to react according to the pre-defined settings. The development idea of the Event manager is based on users' feedbacks. In many cases internal events (such as signal present or HDCP active) are necessary to display but it is not easy when the device is hard to access (e.g. built under the desk). For more details and examples about Event Manager please visit our website (<https://lightware.com/support/guides-and-white-papers>) and download **Event Manager user's guide** in the Downloads section. #eventmanager



The Event manager can be configured to perform an action if a condition has been detected. E.g. the desired setup is that after a certain type of signal has been detected on I1 port, the port has to be switched to O1. The settings can be done via the LDC in the Control/Events tab, or by LW3 protocol commands. Configurable events number depends on the device what you are using actually.

Numerous new ideas and requests have been received in connection with the features and settings of the Event manager since the first release. Therefore, the user interface has been re-designed and many new functions implemented. The Event editor can be opened by pressing the Edit button at each Event.

There is a **grey bar** on the left of the Event panel in each line. If a condition and an action are set and the Event is enabled, the bar is displayed in **green**.

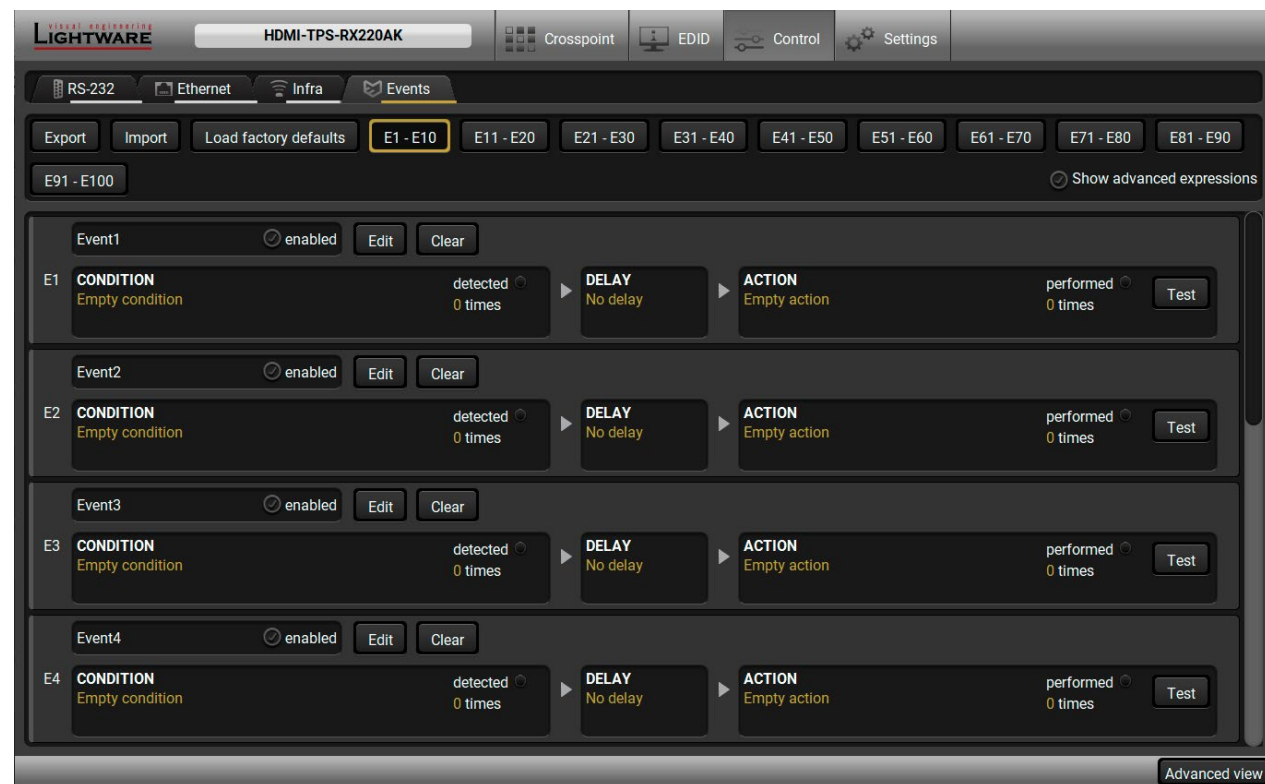

Control menu, Event Manager tab

5.9.1. The Event Editor

Press the **Edit** button in the desired Event line to open the Event editor window.

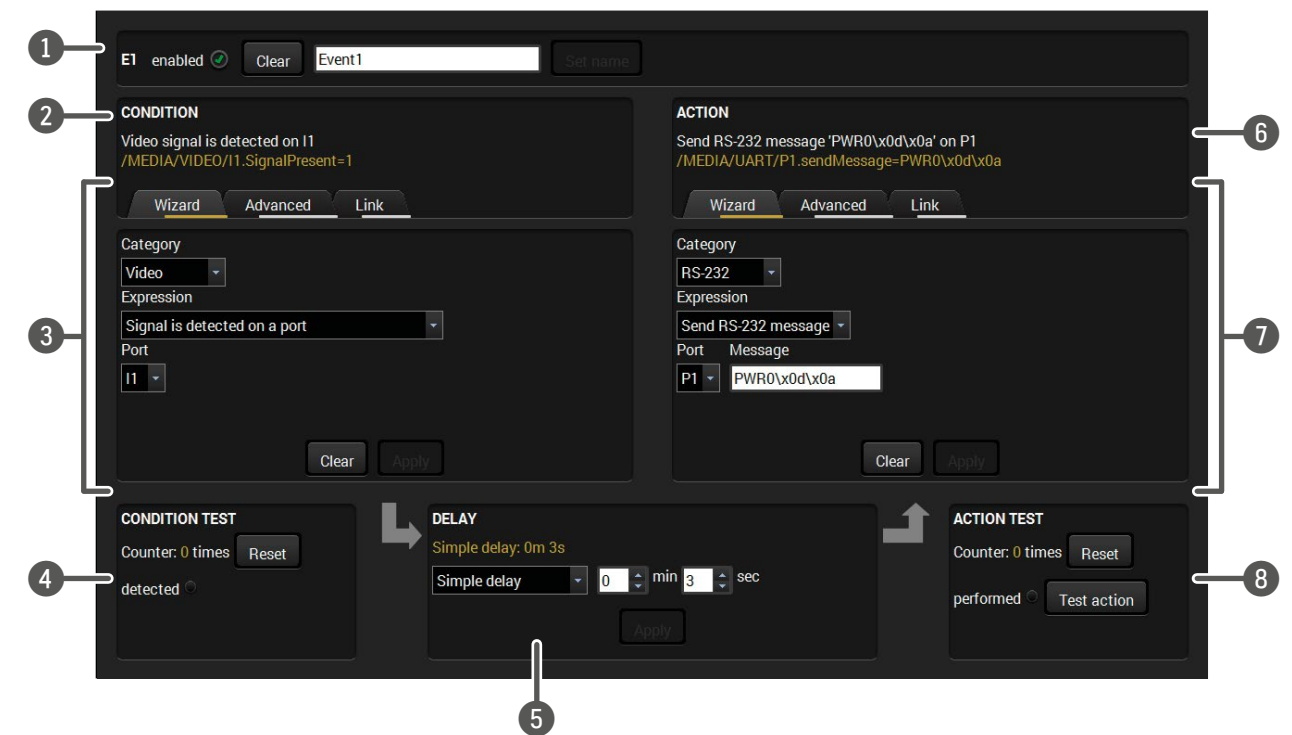

- 1 **Event header** The name of the Event is displayed. Type the desired name and press the Set name button. The Event can be cleared by the Clear button. Use the tick mark to enable/disable the Event.
- 2 **Condition header** If the condition is set, the description (white colored text) and the exact LW3 protocol expression (yellow colored text) can be seen. If the advanced mode was used the description is "Custom condition".
- 3 **Condition panel** The Wizard, the Advanced or the Link tool is available to set the condition. The parameters and settings are displayed below the buttons.
- 4 **Condition test** The set condition can be tested to see the working method in the practice.
- 5 **Delay settings** The action can be scheduled to follow the condition after the set time value.
- 6 **Action header** If the action is set, the description (white colored text) and the exact LW3 protocol expression (yellow colored text) can be seen. If the advanced mode was used the description is "Custom action".
- 7 **Action panel** The Wizard, the Advanced or the Link tool is available to set the action. The parameters and settings are displayed below the buttons.
- 8 **Action test** The set action can be tested to see the working method in the practice.

5.9.2. Create or Modify an Event

Wizard Mode

The wizard mode lists the most common conditions and actions, so the user does not have to look for LW3 nodes and properties.

- Step 1.** Click on the **Edit** button of the desired Event; the **Event editor** is displayed.
- Step 2.** The wizard mode is displayed as default. Select the desired **Category** first (e.g. Audio or Video).
- Step 3.** Select the desired **Expression** from the drop-down menu. If any other parameter is necessary to set, it is going to be displayed.
- Step 4.** Press the **Apply** button to store the settings of the Condition.

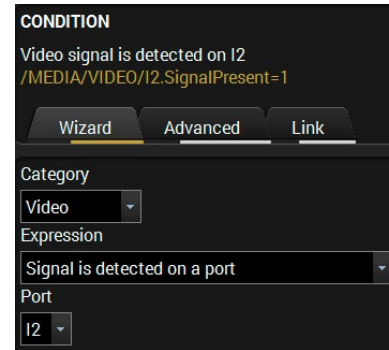

Advanced Mode

The goal of this mode is the same as of the wizard: set the properties and methods for conditions and actions. The difference is the number of the available and usable properties and methods of the LW3 protocol. Advanced mode allows almost all of it.

- Step 1.** Click on the **Edit** button of the desired Event; the **Event editor** is displayed.
- Step 2.** The wizard mode is the default, press the **Advanced** button. The LW3 protocol tree is displayed showing the list of the properties in the drop-down menu. Navigate to the desired node.
- Step 3.** Select the desired **Property** from the menu. The **manual** of the property is displayed below to help to select the necessary property and to set the value.
- Step 4.** Set the desired **value** and **operator**, then press the **Apply** button to store settings.

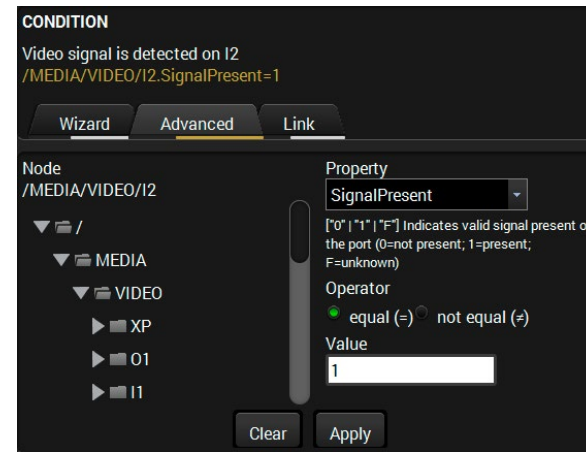

The Link Tool

The new interface allows creating more actions to the same condition. In that case, a condition can trigger more actions. To set such an Event, the Link tool has been introduced.

- Step 1.** Click on the **Edit** button of the desired Event; the **Event editor** is displayed.
- Step 2.** The wizard mode is displayed as default, press the **Link** button.
- Step 3.** All the saved Events are analyzed and the **conditions** are listed (it takes some seconds to finish). The **Show advanced expressions** option allows showing the exact path and set the value of the given property.
- Step 4.** Select the desired **Condition** and press the **Apply** button to store the settings.

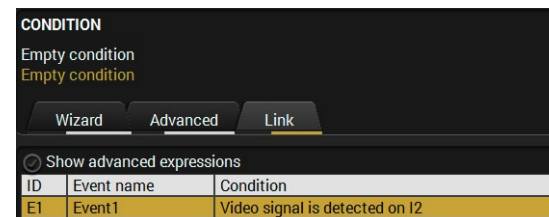

5.9.3. Special Tools and Accessories

The Name of the Event

The name of a port can be changed by typing the new name and clicking the **Set** button. The following characters are allowed when naming:

Letters (A-Z) and (a-z), numbers (0-9), special characters: hyphen (-), underscore (_), and space ().

Enable or Disable an Event

The set Event can be enabled or disabled in the Event list, or directly in the Event editor window by setting the **tick mark** beside the name.

Testing the Condition

When the desired Condition is arranged, the setting can be tested. The Event list and the Event editor contains a small panel that shows if the set condition is detected and how many times. The **Counter** can be reset by the button in Event editor. If the Condition is true, the **detected** mark turns green for two seconds and the **Counter** is increased.

Testing the Action

The method is the same as testing the Condition, but in this case, the Action can be triggered manually by pressing the **Test** button.

TIPS AND TRICKS: The Test button is also placed on the Action panel in the Event list. Thus, you can check the Actions without opening the Event editor.

Delay the Action

In most cases the Action is performed immediately after the Condition is detected. But sometimes a delay is necessary between the Condition and the Action. Therefore, the new Event manager contains the Delay panel which allows that feature with below settings:

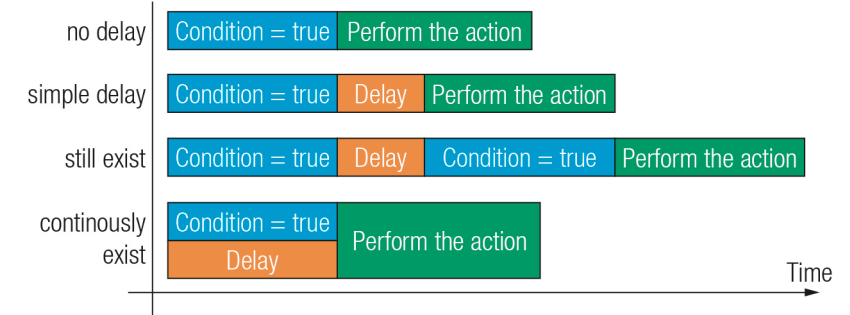

- **No delay:** when the Condition is detected, the Action is launched.
- **Simple delay:** when the Condition is detected, the Action is launched after the set time interval.
- **Still exists:** when the Condition is detected, the Action is launched after the set time interval only if the Condition still exists.
- **Continuously exists:** when the Condition is detected, the Action is launched after the set time interval only if the Condition has been existing continuously.

TIPS AND TRICKS: **Show advanced expressions** option is a useful tool when you look for the path or value of a property but just the expression is displayed. The option is available in the Event list window or when Link tool is used.

5.9.4. Clear One or More Event(s)

Clear an Event

Press the **Clear** button in the Event list or in the header section in the Event editor.

Clear all Events

When all the Events must be cleared press the **Load factory defaults** button above the Event list. You will be prompted to confirm the process.

5.9.5. Export and Import Events

The feature allows saving all the Events. The backup file can be uploaded to another HDMI-TPS-RX220AK receiver.

Export all the Events

Step 1. Press the **Export** button above the Event list.

Step 2. The Save as dialog box will appear. Set the desired folder and file name, then press the **Save** button.

The generated file is a simple text file which contains LW3 protocol commands. The file can be viewed by a simple text editor, e.g. Notepad.

ATTENTION! Editing the file is recommended only for expert users.

Import all the Events

Step 1. Press the **Import** button above the Event list.

Step 2. The Open dialog box will appear. Select the desired folder and file, then press the **Open** button.

5.9.6. Event Creating - Example

The following example shows you on a real-life situation how to set up an Event.

The Concept

The HDMI-TPS-RX220AK receiver is connected to a projector by the HDMI output port. The receiver is also connected to the projector by the RS-232 port and can send commands via the serial line.

The task is to turn on the projector when signal is detected on the HDMI output port.

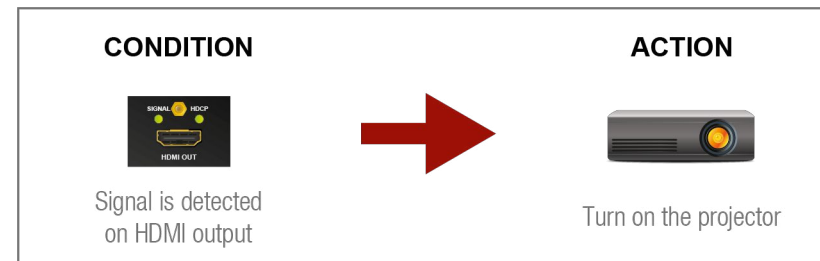

RS-232 Settings

Make sure that the serial line is established between the receiver and the projector. Check that the RS-232 settings of the receiver is set exactly the same which required for the projector: baud rate, data bits, parity, stop bits. The receiver needs to be set to: Control protocol: LW3; and RS-232 mode: Pass-through. See the relevant LDC settings in the [RS-232](#) section.

Setting the Event

You can create the Event in the Wizard in few simple steps:

Step 1. Set the condition.

Select the required parameters to set the condition:

- **Category:** Video;
- **Expression:** Signal is detected on a port;
- **Port:** 01.

Click on the **Apply** button to complete the procedure. When it is done, the condition appears on the upper side in textual and LW3 command format as well.

Step 2. Set the action.

If the condition is fulfilled, the following action needs to be launched: the receiver sends a command to the projector over the serial line:

- **Power on** - the required command which is accepted by the projector: PWR0<CR><LF>

For this instance the command has to be closed with the <CR><LF> characters so they need to be escaped. You can use the following format for escaping:

```
<command1><\x0d\x0a><command2><\x0d\x0a>...
...<commandn><\x0d\x0a>
```

In the current case the command is: PWR0\x0d\x0a

Select the required parameters to set the action:

- **Category:** RS-232;
- **Expression:** Send RS-232 message;
- **Port:** P1;
- **Message:** PWR0\x0d\x0a

Step 3. Enable the Event.

Select the **E1 enabled** pipe in upper left corner to set the Event as launched.

INFO: If you do not find the required category/expression/etc what you need, choose the Advanced mode in the Wizard where the entire LW3 structure tree is available. For example instead of signal detection you can set a specified resolution or color range either as a condition.

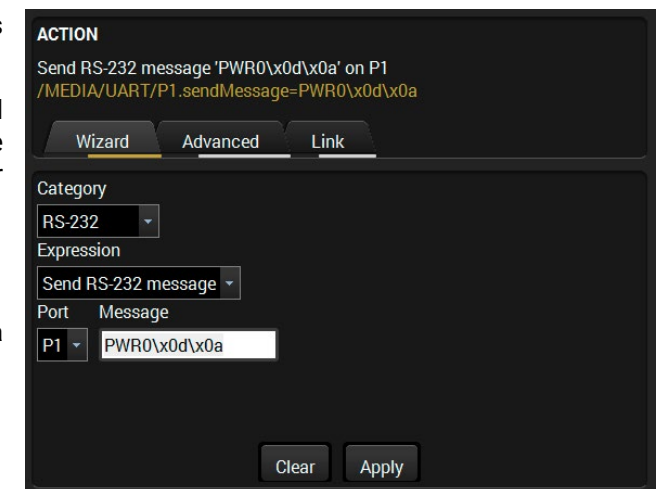
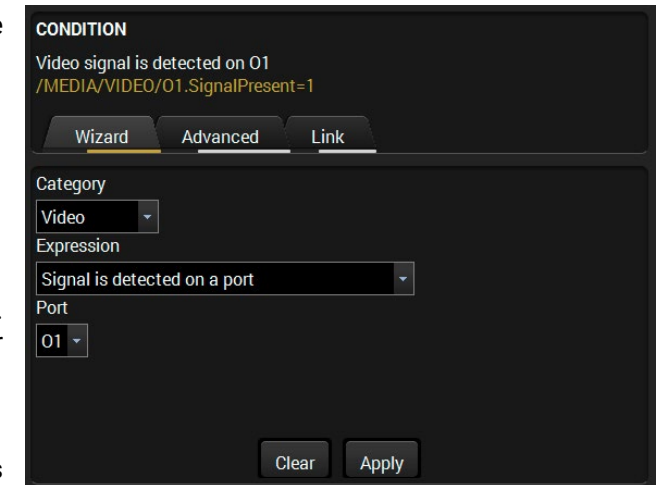

E1 enabled

5.10. Settings Menu

5.10.1. Status

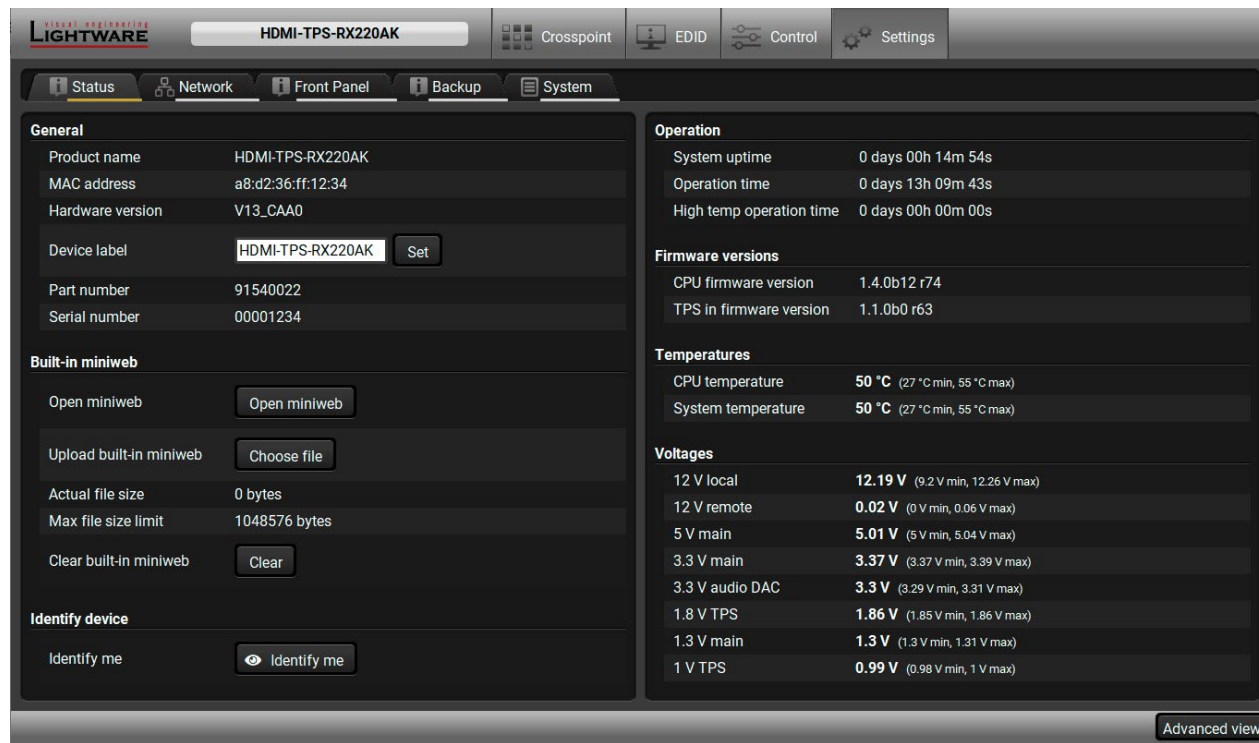

Status tab in Settings menu

The most important hardware and software related information can be found on this tab: hardware and firmware version, serial numbers, temperatures, operation time, and voltage information. Device label can be changed to unique description by the **Set** button. `#firmwareversion #status #devicelabel #label #serialnumber #miniweb #builtinweb #web #producttype`

Please note that the Miniweb-related descriptions can be found in [The Built-in Miniweb](#) section.

Identify Me Feature

Clicking on the **Identify me** button results the blinking of the status (in green) for 10 seconds. The feature helps to identify the device itself in the rack shelf. `#identifyme`



5.10.2. Network

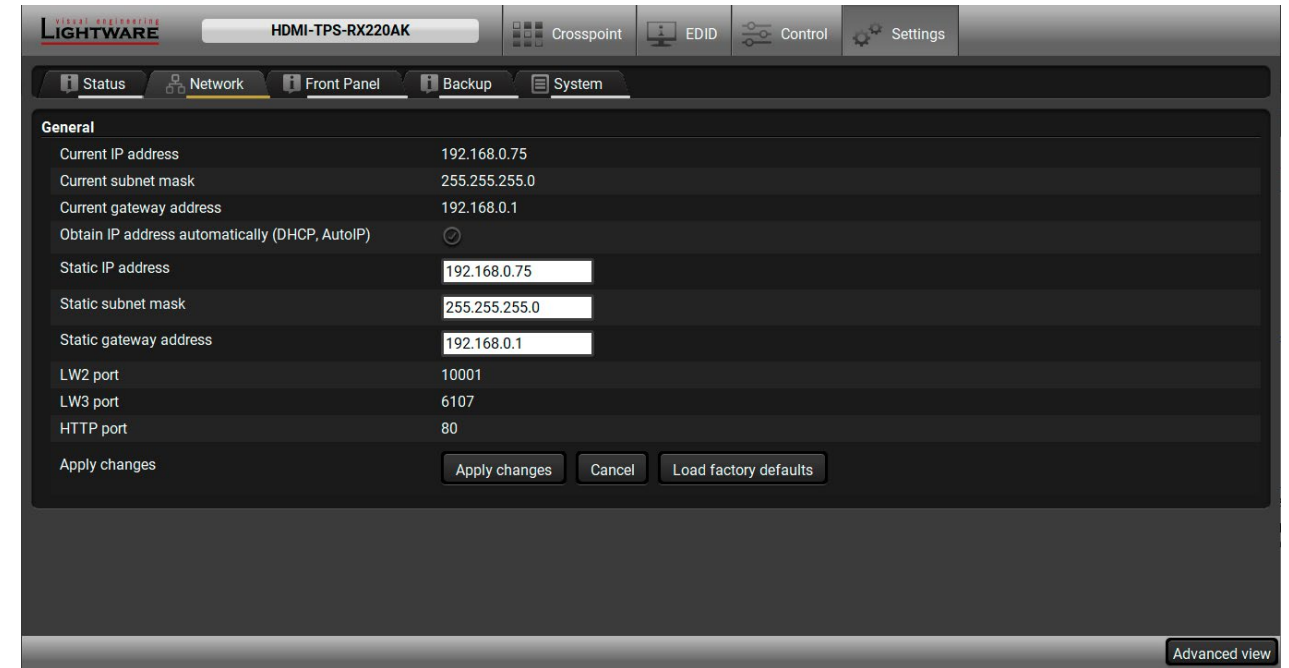

Network tab in Settings menu

IP address and DHCP settings can be set on this tab. Always press the **Apply settings** button to save changes. Factory defaults settings can be recalled with a dedicated button. `#network #dhcp #ipaddress`

5.10.3. Front Panel

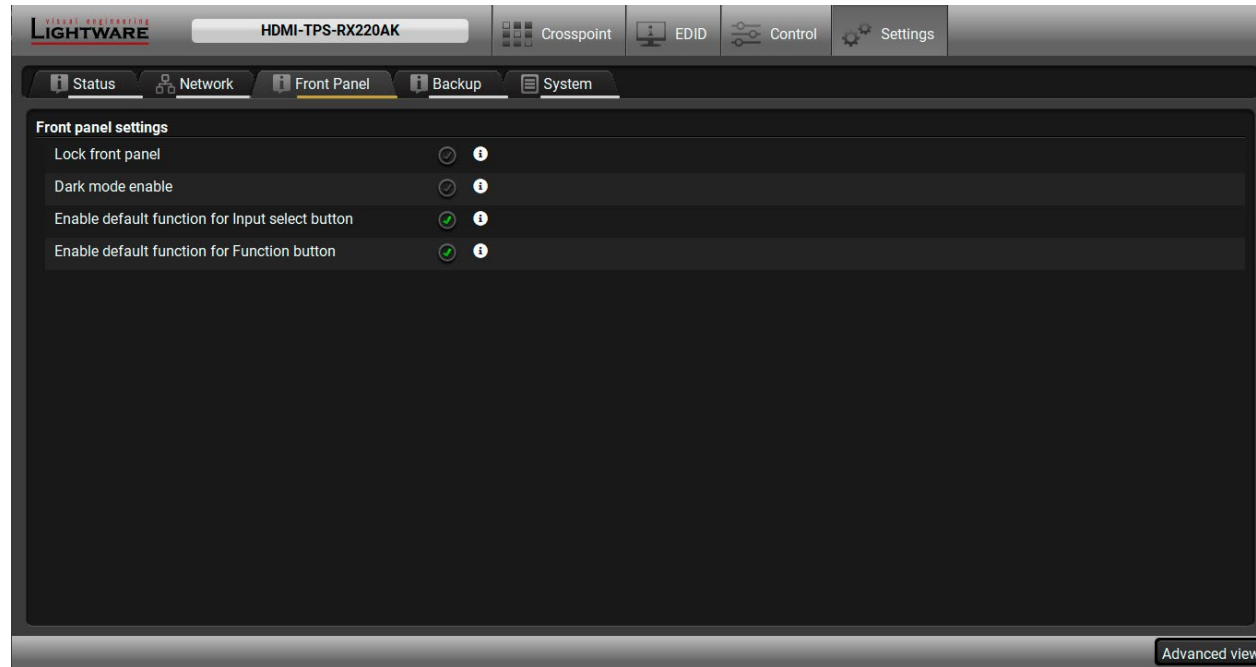

Front panel tab in Settings menu

Available settings:

- **Lock front panel:** the Function button functionally can be disabled with the option is marked.
- **Dark mode enable:** when dark mode is enabled, all status LEDs are switched off after one minute, if no button pressed. Pressing the Function button brings back status info on the LEDs without performing the function of the button itself.
- **Enable default function for Input select button:** enabling the option results the default function of the Function button. See the details about the default function in the [Crosspoint Status LEDs and Input Select Button Functionality](#) section.
- **Enable default function for Function button:** enabling the option results the default function of the Input select button. See the details about the default function in the [Function Button](#) section.

#buttonlock #lockbutton #darkmode

5.10.4. Backup

The details about this function can be found in the [Configuration Cloning \(Backup Tab\)](#) section.

5.10.5. System

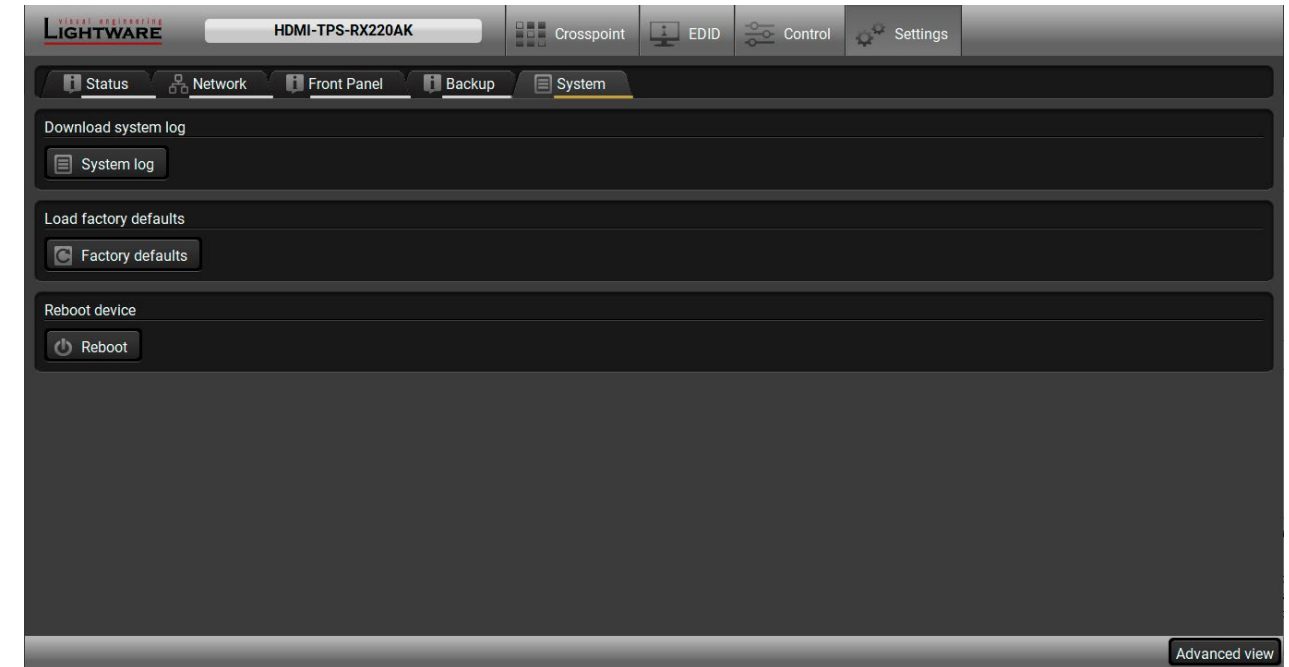

System tab in Settings menu

Three functions are available under System tab:

- **Download system log** - saving the file of the device.
- **Load factory defaults** - recalling [Factory Default Settings](#) and values.
- **Reboot** - rebooting the system.

#log #systemlog #factory #restart #reboot

5.11. The Built-in Miniweb

The default control page allows the followings:

- **Source selection:** This block can be used to select an input or enable/disable the Autoselect remotely e.g. from a mobile device.
- **Action triggers:** The action trigger buttons can be used to perform a configured Event Action without waiting for the condition to occur. This can be done remotely by a mobile device, too.

5.11.1. Opening the Miniweb

The Miniweb is available by:

- Opening the **web browser** and typing the **IP address** of the desired device in the address line,
- Launching the **LDC**, connecting to the device, navigating to **Settings/Status** and pressing the **Open miniweb** button.

If the Miniweb exists the page will be opened. If not, the status page will be displayed (which is also available by opening the `<IP_address>/status.html` address).

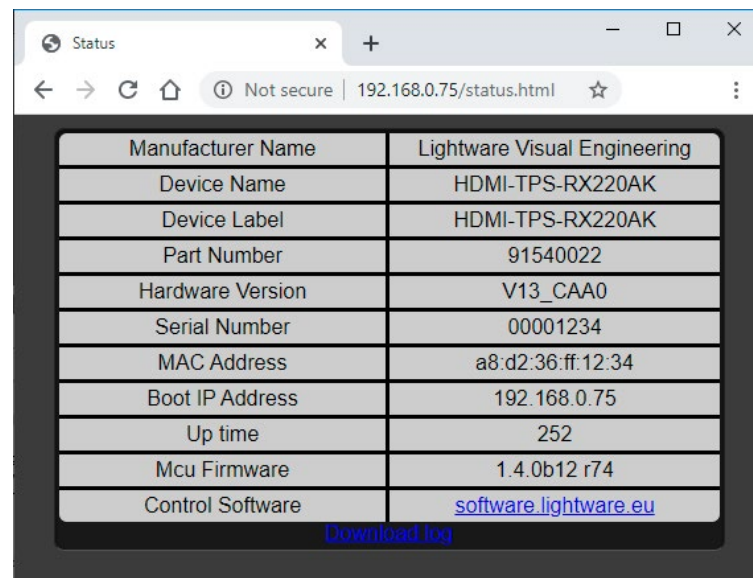

Manufacturer Name	Lightware Visual Engineering
Device Name	HDMI-TPS-RX220AK
Device Label	HDMI-TPS-RX220AK
Part Number	91540022
Hardware Version	V13_CAA0
Serial Number	00001234
MAC Address	a8:d2:36:ff:12:34
Boot IP Address	192.168.0.75
Up time	252
Mcu Firmware	1.4.0b12 r74
Control Software	software.lightware.eu

[Download log](#)

The Factory Default Status Page (status.html)

#miniweb #builtinweb #web

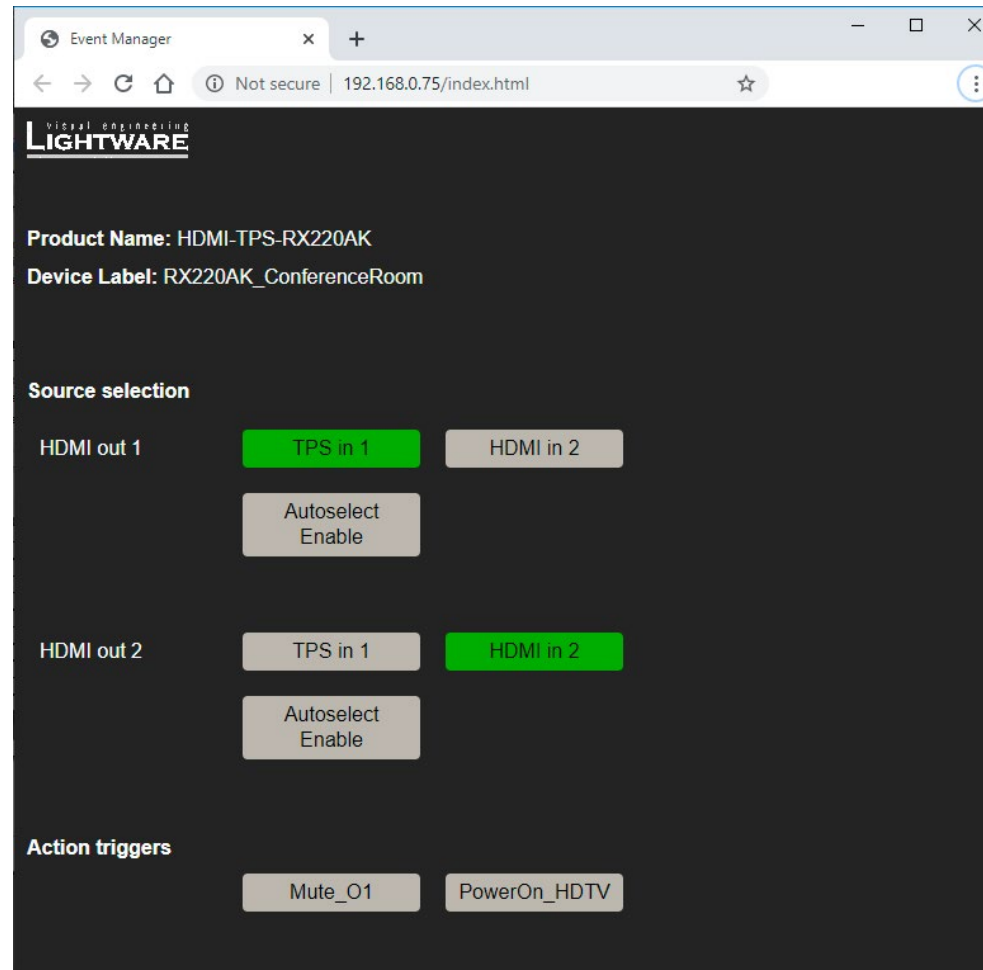

The Default Control Page Displayed in a Desktop Browser and in a Mobile Device

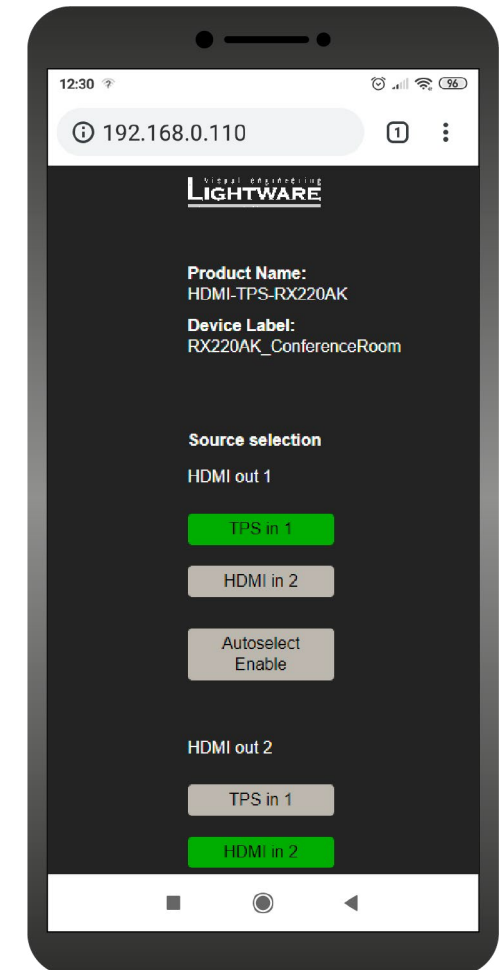

5.11.2. Customization

The buttons of **Action triggers** section are linked to Actions of certain Events in the Event Manager. These buttons are displayed **only** for specific events:

- Any Event which does **not** have the @W suffix in its name will **not** be displayed as a trigger button.
- The displayed trigger buttons will get a **text label** with the **event name** except the suffix.

To add the desired Action as a button, **append the name** of the desired Event with the @W characters - see below:

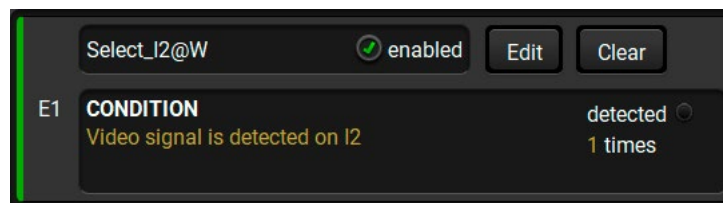

Customized HTML

The default control page can be replaced in the LDC; navigate to the **Settings/Status** page. Custom HTML file can be uploaded by pressing the **Choose file** button. Pay attention to the size of the HTML file. Only one file is allowed and the maximum file size is 10 KB.

Press the **Reset** button to remove the control page.

The screenshot displays the LDC web interface for the HDMI-TPS-RX220AK device. The top navigation bar includes 'Status', 'Network', 'Front Panel', 'Backup', and 'System'. The main content area is divided into several sections:

- General:** Product name (HDMI-TPS-RX220AK), MAC address (a8:d2:36:ff:12:34), Hardware version (V13_CAA0), Device label (HDMI-TPS-RX220AK), Part number (91540022), and Serial number (00001234).
- Built-in miniweb:** Open miniweb, Upload built-in miniweb (Choose file), Actual file size (0 bytes), Max file size limit (1048576 bytes), and Clear built-in miniweb (Clear).
- Identify device:** Identify me (Identify me).
- Operation:** System uptime (0 days 00h 14m 54s), Operation time (0 days 13h 09m 43s), and High temp operation time (0 days 00h 00m 00s).
- Firmware versions:** CPU firmware version (1.4.0b12 r74) and TPS in firmware version (1.1.0b0 r63).
- Temperatures:** CPU temperature (50 °C) and System temperature (50 °C).
- Voltages:** 12 V local (12.19 V), 12 V remote (0.02 V), 5 V main (5.01 V), 3.3 V main (3.37 V), 3.3 V audio DAC (3.3 V), 1.8 V TPS (1.86 V), 1.3 V main (1.3 V), and 1 V TPS (0.99 V).

An 'Advanced view' button is located at the bottom right of the interface.

The Built-in Miniweb Section in LDC

5.12. Configuration Cloning (Backup Tab)

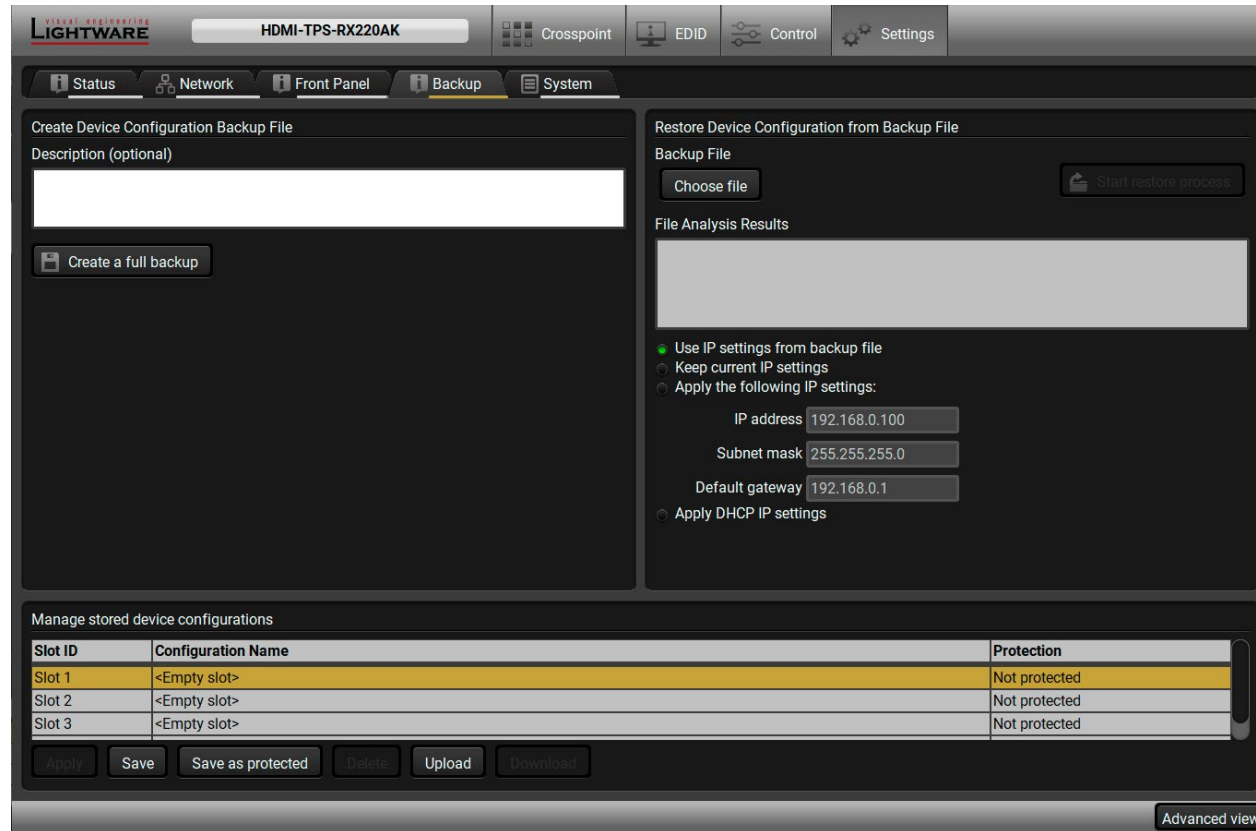

Backup tab

The configuration cloning of Lightware LW3 devices is a simple method that eliminates the need to repeatedly configure certain devices to have identical (non-factory) settings. If the devices are installed in the same type of system multiple times then it is enough to set up only one device to fit the user's needs and then copy those settings to the others, thus saving time and resources.

5.12.1. Cloning Steps in a Nutshell

Installing multiple devices with the same customized configuration settings can be done in a few easy steps:

- Step 1.** Configure one device with all your desired settings with the LDC software.
- Step 2.** Backup the full configuration file to your computer.
- Step 3.** If needed, make some modifications to the configuration file using a text editor (e.g. Notepad). E.g. modifying the static IP address is needed when DHCP is not used.
- Step 4.** Connect to the other device which has to be configured and upload (restore) your configuration file.
- Step 5.** Done! You can have as many totally identical, customized devices as you like.

#backup #configurationcloning

5.12.2. Save the Settings of the Device (Backup)

- Step 1.** Apply the desired settings in the transmitter (port parameters, crosspoint, etc.)
- Step 2.** Select the **Settings / Backup** tab from the menu.
- Step 3.** Write a short **description** in the text box on the left (optional).
- Step 4.** Press the **Create a full backup** button. You will be prompted to save the file to the computer. The default file name is the following:

BACKUP_<DEVICE TYPE>_SN<SERIAL NUMBER>.LW3

- Step 5.** Set the desired **file name**, select the folder and **save** the file.

TIPS AND TRICKS: Using the exact product type in the filename is recommended since it makes the file usage more comfortable.

About the Backup File

The backup file is a simple text file which contains LW3 protocol commands. The first line is the description, and the further lines are the commands which will be executed during the restore process. The file can be viewed (and/or edited) by a simple text editor, e.g. Notepad.

ATTENTION! Editing the command lines is only recommended for expert users.

See the entire list of saved data in the [Content of Backup File](#) section.

5.12.3. Upload the Settings to a Device (Restore)

WARNING! Please note that the settings will be permanently overwritten with the restored parameters in the device. Withdrawal is not possible.

ATTENTION! The cloning is successful when the backup file is downloaded from the same type of source device as the destination device.

The Restoring Process

- Step 1.** Select the **Settings / Backup** tab from the menu.
- Step 2.** Click on the **Choose file** button on the right panel and **browse** the desired file.
- Step 3.** The file is checked and the result will be displayed in the textbox below. If the file is correct, the settings can be restored.
- Step 4.** Choose **IP settings** what you want to use after backup. You can apply settings from the backup file, keep actual settings, set it manually in a dialog box or apply DHCP.
- Step 5.** Press the **Start restore process** button and click on the **Yes** button when asked.
- Step 6.** Reboot the device to apply the network settings after finishing.

5.12.4. Create and Restore Backups from the Device Memory

The receiver is able to store backups in its own memory and can be recalled from there so user does not need to save backup files to the local computer. Four slots are available for this purpose.

Slot ID	Configuration Name	Protection
Slot 1	Preset_0720	Not protected
Slot 2	backup_0125	Protected
Slot 3	<Empty slot>	Not protected
Slot 4	<Empty slot>	Not protected

Buttons: Apply, Save, Save as protected, Delete, Upload, Download

You can save presets as not protected with using **Save** button and as protected with using the **Save as protected** button. Restoring a preset select on the slot of the desired backup and click on the **Apply** button. You can save presets from a file from your local computer clicking on the **Upload** button and you can also save a preset from the device's memory to a backup file with using the **Download** button. If you do not need a saved preset any more, select it and click on the **Delete** button.

WARNING! Loading factory default settings will erase all presets which has been saved in the device memory!

5.13. Advanced View Window



- 1 LW3 protocol help** Pushing the button results a help window opening which describes the most important information about LW3 protocol commands in HTML format.
- 2 Edit mode** The default appearance is the read-only mode. If you want to modify the values or parameters, tick the option. You will be prompted to confirm your selection.
- 3 Warning mode** If this pipe checked in, a warning window pops up when you enable Edit mode.
- 4 Node list** Correspondent parameters and nodes are shown which are connected to the selected item in the protocol tree.
Manual button: Manual (short description) of the node can be called and displayed in the terminal window.
Set button: Saves the value/parameter typed in the textbox.
Call button: Calls the method, e.g. reloads factory default settings.
- 5 Protocol tree** LW3 protocol tree; select an item to see its content.
- 6 Command line** Type the desired command and execute it by the **Send** button. Clear all current commands and responses in the Terminal window by the **Clear** button.
- 7 Terminal window** Commands and responses with time and date are listed in this window. Sent command starts with '>' character, received response starts with '<' character. The color of each item depends on the type of the command and response. The content of the window can be emptied by the **Clear** button. If the **Autoscroll** option is ticked, the list is scrolled automatically when a new line is added.

#terminal #advancedview

6

LW2 Programmer's Reference

The device can be controlled through a reduced command set of LW2 protocol commands to ensure the compatibility with other Lightware products. The supported LW2 commands are described in this chapter.

- ▶ [PROTOCOL DESCRIPTION](#)
- ▶ [INSTRUCTIONS FOR THE TERMINAL APPLICATION USAGE](#)
- ▶ [GENERAL LW2 COMMANDS](#)
- ▶ [CROSSPOINT AND PORT SETTINGS](#)
- ▶ [NETWORK CONFIGURATION](#)
- ▶ [RS-232 SETTINGS](#)
- ▶ [LW2 PROTOCOL COMMANDS – QUICK SUMMARY](#)

6.1. Protocol Description

The protocol description hereinafter stands for Lightware protocol. The commands can be sent to the device in RAW format via the TCP/IP port no. 10001.

The receiver accepts commands surrounded by curly brackets - { } - and responds data surrounded by round brackets - () - only if a command was successfully executed. All input commands are converted to uppercase, but respond commands can contain upper and lower case letters as well.

Legend for Control Commands

Format	Explanation
<in>	Input number in 1 or 2 digit ASCII format (01, 5, 07, 16, etc.)
<out>	Output number in 1 or 2 digit ASCII format
<in/out>	input or output port number in 1 or 2 digit ASCII format *
<in2>	Input number in 2 digit ASCII format (01, 02, 10, 12 etc.)
<out2>	Output number in 2 digit ASCII format (01, 02, 10, 12 etc.)
<in2/out2>	input or output number in 2 digit ASCII format*
<loc>	Location number in 1, 2 or 3 digit ASCII format
<id>	id number in 1 or 2 digit ASCII format
<id2>	id number in 2 digit ASCII format
CrLf	Carriage return, Line feed (0x0D, 0x0A)
.	Space character (0x20)
→	Each command issued by the controller
←	Each response received from the router

* The command has the same arguments on the input ports and the output port, as well.

6.2. Instructions for the Terminal Application Usage

Terminal Application

The LW2 protocol commands can be applied to the receiver using a terminal application. You need to install one of them to your control device, for example **Putty** or **CLI**. *#terminal*

Establishing Connection

Follow the steps for establishing connection to the receiver:

- Step 1.** Connect the receiver to a LAN over Ethernet (see the details in the [Connecting Steps](#) section).
- Step 2.** Open the terminal application (e.g. Putty).
- Step 3.** Add the **IP address** of the device (default: 192.168.0.100) and the **port number** (10001).
- Step 4.** Select the **Raw** connection type, and open the connection.

Once the terminal window is opened, you can enter the LW2 protocol commands which are listed in the following sections.

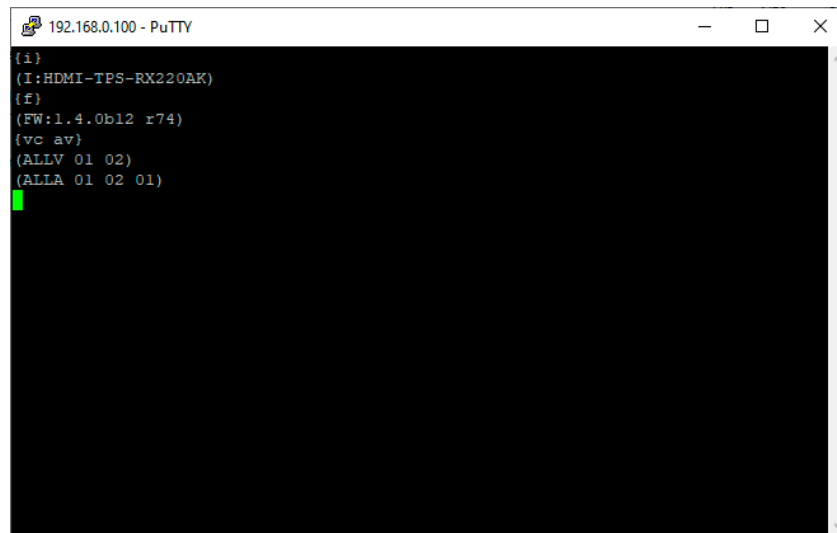
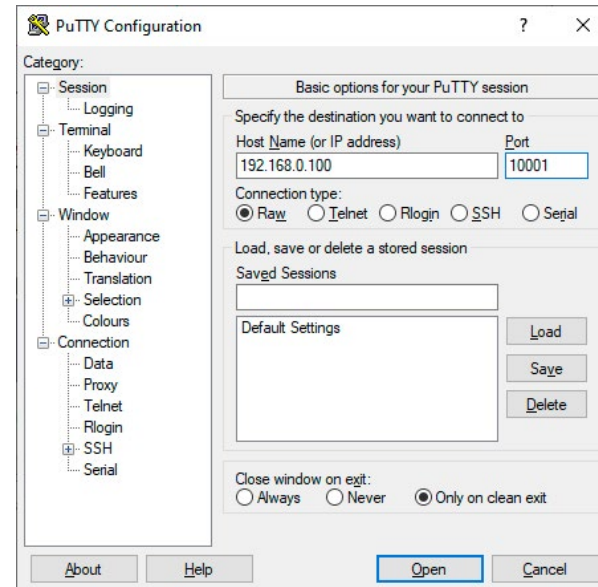

LW2 protocol command communication in a terminal window

6.3. General LW2 Commands

6.3.1. List of All Available LW2 Commands

Command and Response

- {lcmd}
- ← (LCMD# LCMD: List all commands)CrLf
- ← <LW2_commands>CrLf
- ← (LCMD END)CrLf

Example

- {lcmd}
- ← (LCMD# LCMD: List all commands)
- ← (LCMD# PING: Always response PONG)
- ← (LCMD# CT: Compile time)
- ← ...
- ← (LCMD END)

6.3.2. Product Type Query

The device responds its name. *#producttype*

Command and Response

- {i}
- ← (I:<product_type>)CrLf

Example

- {i}
- ← (I:HDMI-TPS-RX220AK)

6.3.3. Control Protocol Query

The device can be controlled with different control protocols. This command queries the active protocol of the currently used control interface. *#protocol*

Command and Response

- {p_?}
- ← (CURRENT·PROTOCOL·=·#<protocol>)CrLf

Example

- {p_?}
- ← (CURRENT PROTOCOL = #1)

Explanation

The device communicates with LW2 protocol.

6.3.4. Firmware Version Query

Command and Response *#firmwareversion*

```
→ {f}
← (FW:<firmware_version>)CrLf
```

Example

```
→ {f}
← (FW:1.4.0b12 r74)
```

6.3.5. Connection Test

Simple test to see if the connection is established successfully.

Command and Response

```
→ {ping}
← (PONG!)CrLf
```

Example

```
→ {ping}
← (PONG!)
```

6.3.6. Serial Number Query

The device responds its 8-digit serial number. *#serialnumber*

Command and Response

```
→ {s}
← (SN:<serial_number>)CrLf
```

Example

```
→ {s}
← (SN:A2000274)
```

6.3.7. Device Label Query

Command and Response

```
→ {label}
← (LABEL=<device_label>)CrLf
```

Example

```
→ {label}
← (LABEL=RX220AK_ConferenceRoom)
```

6.3.8. Installed Board Query

Shows the hardware name and revision of the installed cards.

Command and Response

```
→ {is}
← (SL#·0·<mb_desc>)CrLf
← (SL-END)CrLf
```

Example

```
→ {is}
← (SL# 0 HDMI-TPS-RX220AK)
← (SL END)
```

6.3.9. Firmware Version Query for All Controllers

Shows the firmware versions of all installed controllers. *#firmwareversion*

Command and Response

```
→ {fc}
← (CF·<device>·<firmware_version>)CrLf
← (CF-END)CrLf
```

Example

```
→ {fc}
← (CF HDMI-TPS-RX220AK 1.4.0b12 r74)
← (CF END)
```

6.3.10. Compile Time Query

Returns the date, when the CPU firmware was compiled.

Command and Response

```
→ {ct}
← (COMPILED:·<date>·<time>)CrLf
```

Example

```
→ {ct}
← (Compiled: Jan 29 2020 17:16:28)
```

6.3.11. Health Status Query

Internal voltages and measured temperature values are shown. *#status*

Command and Response

```
→ {st}
← (ST<health_status>)CrLf
```

Example

```
→ {st}
← (ST CPU 12.18V 5.03V 3.30V 0.01V 3.38V 1.30V 1.86V 0.99V 0.01V 53.67C 53.67C)
```

6.3.12. Restarting of the Device

The device can be restarted without unplugging power. *#restart #reboot*

Command and Response

```
→ {rst}
←
```

Example

```
→ {rst}
←
```

6.3.13. Recalling Factory Default Settings

All settings and parameters are reset to factory default, see the table in the [Factory Default Settings](#) section.

#factory

Command and Response

```
→ {factory=all}
← (FACTORY ALL...)CrLf
```

Example

```
→ {factory=all}
← (FACTORY ALL...)
```

6.4. Crosspoint and Port Settings

Port Numbering

Port type	Port	LW2 port number	Applicable media layers		
			Audio	Video	Audio + Video
Input	TPS in 1	01	A	V	AV
	HDMI in 2	02	A	V	AV
Output	HDMI out 1	01	A	V	AV
	HDMI out 2	02	A	V	AV
	Analog audio out	03	A	-	-

6.4.1. Input Switching to an Output

Command and Response *#switch #crosspoint*

```
→ {<in>@<out>·<layer>}
← (0<in>·1<out>·<layer>)CrLf
```

Parameters

Identifier	Parameter description	Value	Parameter value
		A	Audio layer
<layer>	The layer of the HDMI signal	V	Video layer
		AV	Audio and video layers together

Example

```
→ {2@1 AV}
← (002 101 AV)
```

Explanation

The audio and video signals of the HDMI in 2 (02) are selected to the HDMI out 1 (01) port.

ATTENTION! The response of this command does not show if the output is muted. To check the mute status a separate query has to be used like {VC}.

6.4.2. Input Switching to All Outputs

Command and Response

```
→ {<in>@0·<layer>}
← (I<in>·ALL·<layer>)CrLf
```

Parameters

Identifier	Parameter description	Value	Parameter value
		A	Audio layer
<layer>	The layer of the HDMI signal	V	Video layer
		AV	Audio and video layers together

Example

```
→ {1@0 A}
← (I01 ALL A)
```

Explanation

The audio signal of the TPS in 1 (01) is selected to the HDMI out 1, HDMI out 2 and Analog audio out audio ports.

ATTENTION! The response of this command does not show if the output is muted. To check the mute status a separate query has to be used like {VC}.

6.4.3. Mute Output

Command and Response #mute

```
→ {#<out>·<layer>}
← (1MT<out>·<layer>)CrLf
```

Parameters

Identifier	Parameter description	Value	Parameter value
		A	Audio layer
<layer>	The layer of the HDMI signal	V	Video layer
		AV	Audio and video layers together

Example

```
→ {#3 A}
← (1MT03 A)
```

Explanation

The audio signal of the Analog audio out (03) is muted.

6.4.4. Unmute Output

Command and Response #unmute

```
→ {+<out>·<layer>}
← (0MT<out>·<layer>)CrLf
```

Parameters

Identifier	Parameter description	Value	Parameter value
		A	Audio layer
<layer>	The layer of the HDMI signal	V	Video layer
		AV	Audio and video layers together

Example

```
→ {+1}
← (0MT01)
```

Explanation

The audio and video signals of the HDMI out 1 (01) is unmuted.

6.4.5. Lock Output

Lock an output port. The state of the output cannot be changed until unlocking.

Command and Response #lock

```
→ {#><out>·<layer>}
← (1LO<out>·<layer>)CrLf
```

Parameters

Identifier	Parameter description	Value	Parameter value
		A	Audio layer
<layer>	The layer of the HDMI signal	V	Video layer
		AV	Audio and video layers together

Example

```
→ {#>2 V}
← (1LO02 V)
```

Explanation

The video signal of the HDMI out 2 (02) is locked.

6.4.6. Unlock Output

Command and Response *#unlock*

→ {+<<out><layer>}

← (OLO<out><layer>)CrLf

Parameters

Identifier	Parameter description	Value	Parameter value
		A	Audio layer
<layer>	The layer of the HDMI signal	V	Video layer
		AV	Audio and video layers together

Example

→ {+<1>}

← (OLO01)

Explanation

The audio and video signals of the HDMI out 1 (01) is unlocked.

6.4.7. View Connection State on the Outputs

Command and Response *#portstatus*

→ {VC<layer>}

← (ALL<layer><state_letter><in>)CrLf

Parameters

Identifier	Parameter description	Value	Parameter value
		A	Audio layer
<layer>	The layer of the HDMI signal	V	Video layer
		AV	Audio and video layers together
		L	The output port is locked.
<state_letter>	The mute and lock state of the output port.	M	The output port is muted.
		U	The output port is locked and muted.

Example

→ {vc av}

← (ALLV 01 02)

← (ALLA 01 01 01)

Explanation

The TPS in 1 (01) video input port is connected to the HDMI out 1 video output port; the HDMI in 2 (02) video input port is connected to the HDMI out 2 video output port; the HDMI in 1 (01) audio input port is connected to all the audio output ports (HDMI out 1, HDMI out 2, Analog audio out).

6.4.8. View Crosspoint Size

Shows the physical crosspoint size.

Command and Response

→ {GETSIZE<layer>}

← (SIZE=<size><layer>)CrLf

Parameters

Identifier	Parameter description	Value	Parameter value
<size>	The size of the crosspoint	<in> x <out>	The number input ports and the number of output ports separated with an "x".
		A	Audio layer
<layer>	The layer of the HDMI signal	V	Video layer
		AV	Audio and video layers together

Example

→ {getsize av}

← (SIZE=2x2 V)

← (SIZE=2x3 A)

Explanation

The device reports that it has a video crosspoint with 2 inputs and 2 outputs and an audio crosspoint with 2 inputs and 3 outputs.

6.4.9. Autoselect Mode Query

The autoselect mode of the audio or video outputs can be changed.

Command and Response *#autoselect*

```
→ {AS_<layer><out>=?}
← (AS_<layer><out>=<state>;<mode>)CrLf
```

Parameters

Identifier	Parameter description	Value	Parameter value
<layer>	The layer of the HDMI signal	A	Audio layer
		V	Video layer
<state>	Autoselect state	E	Autoselect mode is enabled.
		D	Autoselect mode is disabled.
<mode>	Autoselect mode	F	First detect mode
		L	Last detect mode
		P	Priority detect mode

Example

```
→ {as_v1=?}
← (AS_V1=D;P)
```

Explanation

The Autoselect function is disabled on the video signal of the HDMI out 1 (1) port.

6.4.10. Autoselect Mode Change

The autoselect mode of the audio or video outputs can be changed.

Command and Response

```
→ {AS_<layer><out>=<state>;<mode>}
← (AS_<layer><out>=<state>;<mode>)CrLf
```

Parameters

See at the previous section.

Example

```
→ {as_a2=E;F}
← (AS_A2=E;F)
```

Explanation

The Autoselect function is enabled in first detect mode on the audio signal of the HDMI out 2 (2) port.

6.4.11. Autoselect - Input Priority Query

The settings of audio or video autoselect input priority can be queried as follows.

Command and Response

```
→ {PRIO_<layer><out>=?}
← (PRIO_<layer><out>=<in1_prio>;<in2_prio>)CrLf
```

Parameters

Identifier	Parameter description	Value	Parameter value
<layer>	The layer of the HDMI signal	A	Audio layer
		V	Video layer
<in1_prio>	Priority number of the input ports.	0	Higher priority
		1	Lower priority

Example

```
→ {prio_v1=?}
← (PRIO_V1=0;1)
```

Explanation

The video signal of the TPS in 1 port has the higher priority, the HDMI in 2 has the lower priority.

6.4.12. Autoselect - Input Priority Change

The settings of audio or video autoselect input priority can be changed as follows.

Command and Response

```
→ {PRIO_<layer><out>=<in1_prio>;<in2_prio>}
← (PRIO_<layer><out>=<in1_prio>;<in2_prio>)CrLf
```

Parameters

Identifier	Parameter description	Value	Parameter value
<layer>	The layer of the HDMI signal	A	Audio layer
		V	Video layer
<in1_prio>	Priority number of the input ports.	0	Highest priority
		1	Lowest priority

Example

```
→ {prio_a2=1;0}
← (PRIO_A2=1;0)
```

ATTENTION! Always set all the priority of the ports when changing, otherwise, the change will not be executed and the response will be the current setting (like querying the priority setting).

6.5. Network Configuration

6.5.1. IP Status Query

The network configuration of the device can be queried as follows. *#network #ipaddress #dhcp*

Command and Response

→ {IP_STAT=?}

← (IP_STAT=<mode>;<ip_address>;<subnet_mask>;<gateway_addr>)CrLf

Parameters

Identifier	Parameter description	Value	Parameter value
<mode>	Static IP address setting or DHCP (dynamic IP address)	0	Static IP address
		1	DHCP
<ip_address>	Current IP address of the device		IP address (four decimal octets separated by dots).
<subnet_mask>	Current subnet mask of the device		Subnet mask (four decimal octets separated by dots).
<gateway_address>	Current gateway address of the device		Gateway address (four decimal octets separated by dots).

Example

→ {ip_stat=?}

← (IP_STAT=0;192.168.0.75;255.255.255.0;192.168.0.1)

Explanation

The device has a static (fix) IP address: 192.168.0.75; the subnet mask is 255.255.255.0, the gateway address is 192.168.0.1.

6.5.2. IP Address Query

IP address can be queried as follows.

Command and Response

→ {IP_ADDRESS=?}

← (IP_ADDRESS=<mode>;<ip_address>)CrLf

Parameters

Identifier	Parameter description	Value	Parameter value
<mode>	Static IP address setting or DHCP (dynamic IP address)	0	Static IP address
		1	DHCP
<ip_address>	Current IP address of the device		IP address (four decimal octets separated by dots).

Example

→ {ip_address=?}

← (IP_ADDRESS=1;192.168.2.118)

Explanation

The device has a DHCP (dynamic) IP address: 192.168.2.118.

6.5.3. IP Address Setting

IP address can be set as follows.

Command and Response

→ {IP_ADDRESS=<mode>;<ip_address>}

← (IP_ADDRESS=<mode>;<ip_address>)CrLf

Parameters

Identifier	Parameter description	Value	Parameter value
<mode>	Static IP address setting or DHCP (dynamic IP address)	0	Static IP address
		1	DHCP
<ip_address>	IP address of the device		IP address (four decimal octets separated by dots).

Example

→ {ip_address=1;}

← (IP_ADDRESS=1;192.168.2.118)

Explanation

The device is set to DHCP (dynamic) IP address and got 192.168.2.118.

6.5.4. Subnet Mask Query

IP address can be queried as follows.

Command and Response

```
→ {IP_NETMASK=?}
← (IP_NETMASK=<subnet_mask>)CrLf
```

Parameters

Identifier	Parameter description	Value	Parameter value
<subnet_mask>	Current subnet mask of the device		Subnet mask (four decimal octets separated by dots).

Example

```
→ {ip_netmask=?}
← (IP_NETMASK=255.255.255.0)
```

6.5.5. Subnet Mask Setting

IP address can be set as follows.

Command and Response

```
→ {IP_NETMASK=<subnet_mask>}
← (IP_NETMASK=<subnet_mask>)CrLf
```

Parameters

Identifier	Parameter description	Value	Parameter value
<subnet_mask>	Subnet mask of the device		Subnet mask (four decimal octets separated by dots).

Example

```
→ {ip_netmask=255.255.0.0}
← (IP_NETMASK=255.255.0.0)
```

6.5.6. Gateway Address Query

Gateway address can be queried as follows.

Command and Response

```
→ {IP_GATEWAY=?}
← (IP_GATEWAY=<gateway_address>)CrLf
```

Parameters

Identifier	Parameter description	Value	Parameter value
<gateway_address>	Current gateway address of the device		Gateway address (four decimal octets separated by dots).

Example

```
→ {ip_gateway=?}
← (IP_GATEWAY=192.168.0.1)
```

6.5.7. Subnet Mask Setting

Gateway address can be set as follows.

Command and Response

```
→ {IP_GATEWAY=<gateway_address>}
← (IP_GATEWAY=<gateway_address>)CrLf
```

Parameters

Identifier	Parameter description	Value	Parameter value
<gateway_address>	Current gateway address of the device		Gateway address (four decimal octets separated by dots).

Example

```
→ {ip_gateway=192.168.0.1}
← (IP_GATEWAY=192.168.0.1)
```

6.5.8. Apply Network Settings

Applying the network settings and restart the network interface.

ATTENTION! The command is always requires as the last step for applying the modified network settings.

Command and Response

```
→ {IP_APPLY}
← (IP_APPLY)CrLf
```

Example

```
→ {ip_apply}
← (IP_APPLY)
```

6.6. RS-232 Settings

6.6.1. RS-232 Mode Setting

RS -232 mode can be set as follows. See more details about RS -232 modes in the [Serial Interface](#) section.

#rs232 #rs-232 #serial #commandinjection #protocol

Command and Response

```
→ {RS232=<mode>}
← (RS232=<mode>)CrLf
```

Parameters

Identifier	Parameter description	Value	Parameter value
		CONTROL	Control mode
<mode>	RS-232 operation mode	CI	Command injection mode
		PASS	Pass-through mode

Example

```
→ {rs232=control}
← (RS232=CONTROL)
```

INFO: The current RS-232 mode can be queried by the {RS232=?} command.

6.6.2. Local RS-232 Parameters Settings

The parameters of local RS -232 port can be set as follows.

Command and Response

```
→ {RS232_LOCAL_FORMAT=<BaudRate>;<DataBit>;<Parity>;<StopBit>}
← (RS232_LOCAL_FORMAT=<BaudRate>;<DataBit>;<Parity>;<StopBit>)CrLf
```

Parameters

Identifier	Parameter description	Value	Parameter value
		X	No change
		4800	4800
		7200	7200
		9600	9600
<BaudRate>	Baud rate	14400	14400
		19200	19200
		38400	38400
		57600	57600
		115200	115200
		X	No change
<DataBit>	Data bit	8	8
		9	9
		X	No change
<Parity>	Parity	N	None
		E	Even
		O	Odd
		X	No change
<StopBit>	Stop Bit	1	1
		1,5	1,5
		2	2

Example

```
→ {rs232_local_format=9600;8;O;X}
← (RS232_LOCAL_FORMAT=9600;8;O;X)
```

Explanation

Local RS -232 port is set as the following: the baud rate to 9600, data bit to 8, parity to odd, and stop bit is not changed, remained 1.

INFO: The current local RS-232 parameters can be queried by the {RS232_LOCAL_FORMAT=?} command.

6.6.3. Link RS-232 Parameters Settings

The parameters of link RS -232 (TPS) port can be set as follows.

Command and Response

→ {RS232_LINK_FORMAT=<BaudRate>;<DataBit>;<Parity>;<StopBit>}

← (RS232_LINK_FORMAT=<BaudRate>;<DataBit>;<Parity>;<StopBit>)CrLf

Parameters

Identifier	Parameter description	Value	Parameter value
<BaudRate>	Baud rate	X	No change
		4800	4800
		7200	7200
		9600	9600
		14400	14400
		19200	19200
		38400	38400
		57600	57600
		115200	115200
		<DataBit>	Data bit
8	8		
9	9		
<Parity>	Parity	X	No change
		N	None
		E	Even
		O	Odd
<StopBit>	Stop Bit	X	No change
		1	1
		1,5	1,5
		2	2

Example

→ {rs232_link_format=9600;8;O;X}

← (RS232_LINK_FORMAT=9600;8;O;X)

Explanation

Link RS -232 port is set as the following: the baud rate to 9600, data bit to 8, parity to odd, and stop bit is not changed, remained 1.

INFO: The current link RS-232 parameters can be queried by the {RS232_LINK_FORMAT=?} command.

6.6.4. Local RS-232 Control Protocol Port Setting

The control protocol of local RS -232 port can be set as follows.

Command and Response

→ {RS232_LOCAL_PROT=<protocol>}

← (RS232_LOCAL_PROT=<protocol>)CrLf

Parameters

Identifier	Parameter description	Value	Parameter value
<protocol>	RS-232 control protocol	LW2	LW2 control protocol
		LW3	LW3 control protocol

Example

→ {rs232_local_prot=lw2}

← (RS232_LOCAL_PROT=LW2)

INFO: The current local RS-232 parameters can be queried by the {RS232_LOCAL_PROT=?} command.

6.6.5. Link RS-232 Control Protocol Port Setting

The control protocol of link RS -232 (TPS) port can be set as follows.

Command and Response

→ {RS232_LINK_PROT=<protocol>}

← (RS232_LINK_PROT=<protocol>)CrLf

Parameters

Identifier	Parameter description	Value	Parameter value
<protocol>	RS-232 control protocol	LW2	LW2 control protocol
		LW3	LW3 control protocol

Example

→ {rs232_link_prot=lw2}

← (RS232_LINK_PROT=LW2)

INFO: The current local RS-232 parameters can be queried by the {RS232_LINK_PROT=?} command.

6.7. LW2 Protocol Commands – Quick Summary

General LW2 Commands

List of All Available LW2 Commands

→ {lcmd}

Product Type Query

→ {i}

Control Protocol Query

→ {p_?}

Firmware Version Query

→ {f}

Connection Test

→ {ping}

Serial Number Query

→ {s}

Device Label Query

→ {label}

Installed Board Query

→ {is}

Firmware Version Query for All Controllers

→ {fc}

Compile Time Query

→ {ct}

Health Status Query

→ {st}

Restarting of the Device

→ {rst}

Recalling Factory Default Settings

→ {factory=all}

Crosspoint and Port Settings

Input Switching to an Output

→ {<in>@<out>·<layer>}

Input Switching to All Outputs

→ {<in>@0·<layer>}

Mute Output

→ {#<out>·<layer>}

Unmute Output

→ {+<out>·<layer>}

Lock Output

→ {#><out>·<layer>}

Unlock Output

→ {+<<out>·<layer>}

View Connection State on the Outputs

→ {VC·<layer>}

View Crosspoint Size

→ {GETSIZE·<layer>}

Autoselect Mode Query

→ {AS_<layer><out>=?}

Autoselect Mode Change

→ {AS_<layer><out>=<state>;<mode>}

Autoselect - Input Priority Query

→ {PRIO_<layer><out>=?}

Autoselect - Input Priority Change

→ {PRIO_<layer><out>=<in1_prio>;<in2_prio>}

Network Configuration

IP Status Query

→ {IP_STAT=?}

IP Address Query

→ {IP_ADDRESS=?}

IP Address Setting

→ {IP_ADDRESS=<mode>;<ip_address>}

Subnet Mask Query

→ {IP_NETMASK=?}

Subnet Mask Setting

→ {IP_NETMASK=<subnet_mask>}

Gateway Address Query

→ {IP_GATEWAY=?}

Subnet Mask Setting

→ {IP_GATEWAY=<gateway_address>}

Apply Network Settings

→ {IP_APPLY}

RS-232 Settings

RS-232 Mode Setting

→ {RS232=<mode>}

Local RS-232 Parameters Settings

→ {RS232_LOCAL_FORMAT=<BaudRate>;<DataBit>;<Parity>;<StopBit>}

Link RS-232 Parameters Settings

→ {RS232_LINK_FORMAT=<BaudRate>;<DataBit>;<Parity>;<StopBit>}

Local RS-232 Control Protocol Port Setting

→ {RS232_LOCAL_PROT=<protocol>}

Link RS-232 Control Protocol Port Setting

→ {RS232_LINK_PROT=<protocol>}

7

LW3 Programmer's Reference

The device can be controlled through Lightware 3 (LW3) protocol commands to ensure the compatibility with other Lightware products. The supported LW3 commands are described in this chapter

- ▶ OVERVIEW
- ▶ INSTRUCTIONS FOR THE TERMINAL APPLICATION USAGE
- ▶ PROTOCOL RULES
- ▶ SYSTEM COMMANDS
- ▶ VIDEO PORT SETTINGS
- ▶ AUDIO PORT SETTINGS
- ▶ ANALOG AUDIO OUTPUT SETTINGS
- ▶ NETWORK CONFIGURATION
- ▶ RS-232 PORT CONFIGURATION
- ▶ RS-232 RECOGNIZER
- ▶ INFRARED PORT CONFIGURATION
- ▶ SENDING MESSAGE VIA THE COMMUNICATION PORTS
- ▶ SENDING CEC COMMANDS
- ▶ EDID MANAGEMENT
- ▶ LW3 PROTOCOL COMMANDS - QUICK SUMMARY

7.1. Overview

The Lightware Protocol #3 (LW3) is implemented in almost all new Lightware devices (matrix switchers, signal extenders and distribution amplifiers) since 2012. The protocol is ASCII-based and all commands are terminated with a carriage return (Cr, '\r') and line feed (Lf, '\n') pair. It is organized as a tree structure that provides outstanding flexibility and user-friendly handling with 'nodes', 'properties' and 'methods'. The **Advanced View** of the Lightware Device Controller software is the perfect tool for browsing and learning how the LW3 protocol can be used in practice.

7.2. Instructions for the Terminal Application Usage

Terminal Application

The LW3 protocol commands can be applied to the receiver using a terminal application. You need to install one of them to your control device, for example **PuTTY** or **CLI**. `#terminal`

Establishing Connection

Follow the steps for establishing connection to the receiver:

- Step 1.** Connect the receiver to a LAN over Ethernet (see the details in the [Connecting Steps](#) section).
- Step 2.** Open the terminal application (e.g. PuTTY).
- Step 3.** Add the **IP address** of the device (default: 192.168.0.100) and the **port number (6107)**.
- Step 4.** Select the **Raw** connection type, and open the connection.

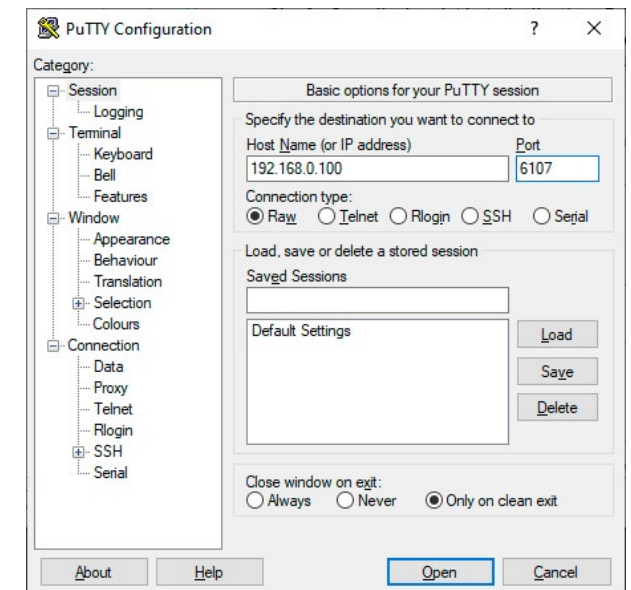

Once the terminal window is opened, you can enter the LW3 protocol commands which are listed in the following sections.

```

192.168.0.100 - PuTTY
GET /MEDIA/VIDEO/XP.SourcePortStatus
pr /MEDIA/VIDEO/XP.SourcePortStatus=T00AA;T00AA
CALL /MEDIA/VIDEO/XP:switch(I1:O2)
mO /MEDIA/VIDEO/XP:switch
1700#GET /EDID.*
{1700
pr /EDID.EdidStatus=F47:E1;F47:E2
m- /EDID:copy
m- /EDID:delete
m- /EDID:reset
m- /EDID:switch
m- /EDID:switchAll
}

```

LW3 protocol command communication in a terminal window

7.3. Protocol Rules

7.3.1. LW3 Tree Structure and Command Structure (examples)

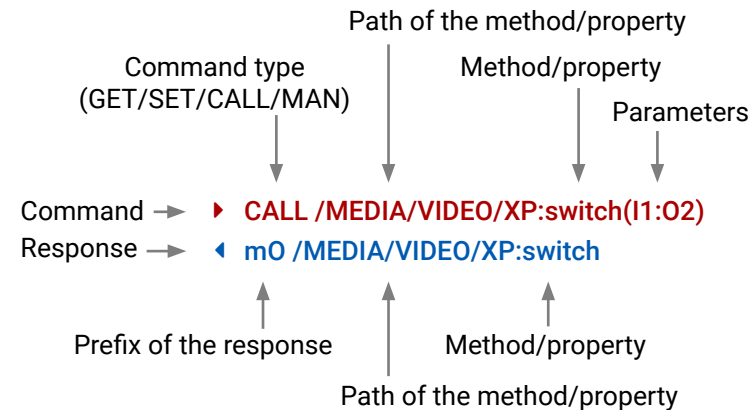
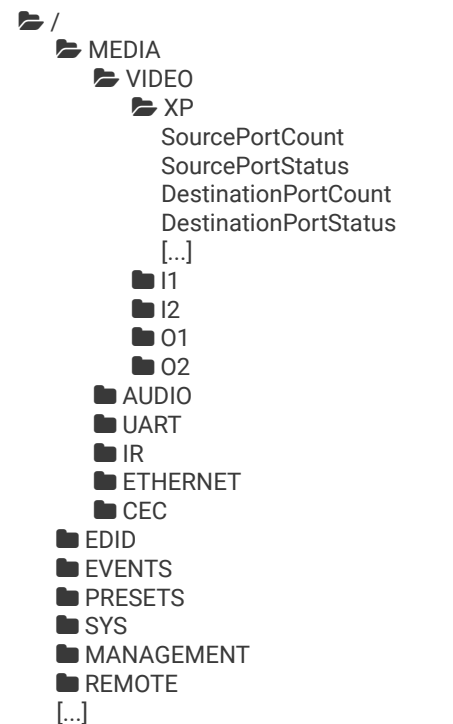

7.3.2. General Rules

- All names and parameters are **case-sensitive**.
- The nodes are separated by a slash ('/') character.
- The node name can contain the elements of the English alphabet and numbers.
- Use the **TCP port no. 6107** when using LW3 protocol over Ethernet.
- When a command is issued by the device, the received response cannot be processed by the CPU.
- The node paths describe the exact location of the node, listing each parent node up to the root.

7.3.3. Command Types

GET command

The **GET** command can be used to get the child nodes, properties and methods of a specific node. It can also be used to get the value of a property. Use the dot character (.) when addressing a property:

- ▶ **GET /.SerialNumber**
- ◀ **pr /.SerialNumber=87654321**

GETALL command

The **GETALL** command can be used to get all child nodes, properties and methods of a node with one command.

- ▶ **GETALL /MEDIA/UART**
- ◀ **ns /MEDIA/UART/RECOGNIZER**
- ◀ **ns /MEDIA/UART/P1**
- ◀ **ns /MEDIA/UART/P2**
- ◀ **pr /MEDIA/UART.PortCount=2**
- ◀ **pr /MEDIA/UART.PortUi=P1:12209;P2:12224**
- ◀ **pr /MEDIA/UART.P1=Local RS-232**
- ◀ **pr /MEDIA/UART.P2=TPS in RS-232**

SET command

The **SET** command can be used to modify the value of a property. Use the dot character (.) when addressing the property:

- ▶ **SET /MEDIA/VIDEO/O1.TpgPattern=CYCLE**
- ◀ **pw /MEDIA/VIDEO/O1.TpgPattern=CYCLE**

CALL command

A method can be invoked by the **CALL** command. Use the colon character (:) when addressing the method:

- ▶ **CALL /EDID:switchAll(F49)**
- ◀ **mO /EDID:switchAll**

MAN command

The manual is a human readable text that describes the syntax and provides a hint for how to use the primitives. For every node, property and method in the tree there is a manual, type the MAN command to get the manual:

- ▶ **MAN /MEDIA/VIDEO/O1.Pwr5vMode**
- ◀ **pm /MEDIA/VIDEO/O1.Pwr5vMode ["0" | "1" | "2"] 0 - Auto, 1 - Always On, 2 - Always Off**

7.3.4. Prefix Summary

DEFINITION: The prefix is a 2-character long code that describes the type of the response.

The following prefixes are defined in the LW3 protocol:

Prefix	Description	Prefix	Description
n-	a node	pm	a manual for the property
nE	an error for a node	m-	a method
nm	a manual for a node	mO	a response after a success method execution
pr	a read-only property	mF	a response after a failed method execution
pw	read-write property	mE	an error for a method
pE	an error for the property	mm	a manual for a method

7.3.5. Error Messages

There are several error messages defined in the LW3 protocol, all of them have a unique error number.

- ▶ **CALL /MEDIA/VIDEO/XP:lock(IA)**
- ◀ **mE /MEDIA/VIDEO/XP:lock %E002:Not exist**

7.3.6. Escaping

DEFINITION: An escape sequence is a sequence of characters that does not represent itself when used inside a character or string literal, but is translated into another character or a sequence of characters.

Property values and method parameters can contain characters which are used as control characters in the protocol. They must be escaped. The escape character is the backslash ('\') and escaping means injecting a backslash before the character that should be escaped (like in C language).

Control characters are the following: \ { } # % () \r \n \t

The **original** message: **CALL /MEDIA/UART/P1:sendMessage(Set(01))**

The **escaped** message: **CALL /MEDIA/UART/P1:sendMessage(Set\\(01\\))**

7.3.7. Signature

DEFINITION: The signature is a four-digit-long hexadecimal value that can be optionally placed before every command to keep a command and the corresponding responses together as a group.

Each line is terminated with a carriage return (Cr, '\r') and line feed (Lf, '\n') characters. In several cases the number of the lines in the response cannot be determined in advance, e.g. the client intends to receive for the whole response and also wants to be sure, that the received lines belong together and to the same command. In these cases, a special feature the 'signature' can be used. The response to that particular command will also be preceded by the signature, and the corresponding lines will be between brackets:

- ▶ **1700#GET /EDID.***
- ◀ {1700
- ◀ **pr /EDID.EdidStatus=F47:E1;F47:E2**
- ◀ **m- /EDID:copy**
- ◀ **m- /EDID:delete**
- ◀ **m- /EDID:reset**
- ◀ **m- /EDID:switch**
- ◀ **m- /EDID:switchAll**
- ◀ }

INFO: The lines of the signature are also Cr and Lf terminated.

7.3.8. Subscription

DEFINITION: Subscription to a node means that the user will get a notification if a property of the node changes.

A user can subscribe to any node. These notifications are asynchronous messages and are useful to keep the client application up to date, without having to periodically poll the node to detect a changed property. When the user does not want to be informed about the changes anymore, he can simply unsubscribe from the node.

ATTENTION! The subscriptions are handled separately for connections. Hence, if the connection is terminated all registered subscriptions are deleted. After reopening a connection all subscribe commands have to be sent in order to get the notifications of the changes on that connection.

Subscribe to a Node

- ▶ **OPEN /MEDIA/VIDEO**
- ◀ **o- /MEDIA/VIDEO**

Get the Active Subscriptions

- ▶ **OPEN**
- ◀ **o- /MEDIA/VIDEO**
- ◀ **o- /EDID**
- ◀ **o- /DISCOVERY**

Subscribe to Multiple Nodes

- ▶ **OPEN /MEDIA/VIDEO/***
- ◀ **o- /MEDIA/VIDEO/***

Unsubscribe from a Node

- ▶ **CLOSE /MEDIA/VIDEO**
- ◀ **c- /MEDIA/VIDEO**

Unsubscribe from Multiple Nodes

- ▶ **CLOSE /MEDIA/VIDEO/***
- ◀ **c- /MEDIA/VIDEO/***

7.3.9. Notifications about the Changes of the Properties

When the value of a property is changed and the user is subscribed to the node, which the property belongs to, an asynchronous notification is generated. This notification is called as the 'change message'. The format of such a message is very similar to the response for the **GET** command:

◀ CHG /EDID.EdidStatus=F48:E1

A Short Example of How to Use the Subscription

There are two independent users controlling the device through two independent connections (**Connection #1** and **Connection #2**). The events in the rows occur after each other.

▶ OPEN /MEDIA/AUDIO/O3	}	Connection #1
◀ o- /MEDIA/AUDIO/O3		
▶ GET /MEDIA/AUDIO/O3.VolumePercent	}	Connection #2
◀ pw /MEDIA/AUDIO/O3.VolumePercent=100.00		
▶ GET /MEDIA/AUDIO/O3.VolumePercent	}	Connection #2
◀ pw /MEDIA/AUDIO/O3.VolumePercent=100.00		
▶ SET /MEDIA/AUDIO/O3.VolumePercent=50.00	}	Connection #1
◀ pw /MEDIA/AUDIO/O3.VolumePercent=50.00		
◀ CHG /MEDIA/AUDIO/O3.VolumePercent=50.00	→	Connection #1

Explanation: The first user (**Connection #1**) set a subscription to a node. Later the other user (**Connection #2**) made a change, and thanks for the subscription, the first user got a notification about the change.

7.3.10. Legend for the Control Commands

Format	Description
<in>	Input port number
<out>	Output port number
<port>	Input or output port number
<loc>	Location number
<parameter>	Variable, which is defined and described in the command
<expression>	Batched parameters: the underline means that more expressions or parameters can be placed by using a semicolon, e.g. O1;O2 or F27:U1;F47:U2
▶	Sent command
◀	Received response
.	Space character

7.4. System Commands

7.4.1. Query the Product Name

The name of the product is a read-only parameter and cannot be modified.

Command and Response *#producttype*

▶ GET /.ProductName

◀ pr /.ProductName=<Product_name>

Example

▶ GET /.ProductName

◀ pr /.ProductName=HDMI-TPS-RX220AK

7.4.2. Set the Device Label

ATTENTION! The device label can be changed to a custom text in the **Status** tab of the LDC software. This writable parameter is not the same as the ProductName parameter.

Command and Response *#devicelabel #label*

▶ SET /MANAGEMENT/UID/DeviceLabel=<Custom_name>

◀ pw /MANAGEMENT/UID/DeviceLabel=<Custom_name>

The Device Label can be 39 character length and ASCII characters are allowed. Longer names are truncated.

Example

▶ SET /MANAGEMENT/UID.DeviceLabel=RX220_Conference1

◀ pw /MANAGEMENT/UID.DeviceLabel=RX220_Conference1

7.4.3. Query the Serial Number

Command and Response *#serialnumber*

▶ GET /.SerialNumber

◀ pr /.SerialNumber=<serial_number>

Example

▶ GET /.SerialNumber

◀ pr /.SerialNumber=87654321

7.4.4. Query the Firmware Version

Command and Response *#firmwareversion*

- ▶ GET·/SYS/MB.FirmwareVersion
- ◀ pr·/SYS/MB.FirmwareVersion=<firmware_version>

Example

- ▶ GET /SYS/MB.FirmwareVersion
- ◀ pr /SYS/MB.FirmwareVersion=1.4.0b12 r74

7.4.5. Identify the Device

Calling the method results the blinking of the status LEDs for 10 seconds. The feature helps to identify the device itself in the rack shelf.

Command and Response *#identifyme*

- ▶ CALL·/MANAGEMENT/UI:identifyMe()
- ◀ mO·/MANAGEMENT/UI:identifyMe=

Example

- ▶ CALL /MANAGEMENT/UI:identifyMe()
- ◀ mO /MANAGEMENT/UI:identifyMe

7.4.6. Dark Mode

This command turns LEDs off the on the transmitter.

Command and Response *#darkmode*

- ▶ SET·/MANAGEMENT/UI/DARKMODE.DarkModeEnable=<logical_value>
- ◀ pw·/MANAGEMENT/UI/DARKMODE.DarkModeEnable=<logical_value>

Parameters

Identifier	Parameter description	Value	Explanation
<logical_value>	Status of the dark mode	true	Dark mode is enabled.
		false	Dark mode is disabled.

Example

- ▶ SET /MANAGEMENT/UI/DARKMODE.DarkModeEnable=true
- ◀ pw /MANAGEMENT/UI/DARKMODE.DarkModeEnable=true

7.4.7. Control Lock

Enable/disable the operation of the front panel buttons.

Command and Response *#controllock*

- ▶ SET·/MANAGEMENT/UI.ControlLock=<mode>
- ◀ pw·/MANAGEMENT/UI.ControlLock=<mode>

Parameters

Identifier	Parameter description	Value	Explanation
<mode>	Control lock mode	0	Disabled
		1	Locked
		2	Force locked.

Example

- ▶ SET /MANAGEMENT/UI.ControlLock=1
- ◀ pw /MANAGEMENT/UI.ControlLock=1

7.4.8. Restarting the Device

The receiver can be restarted – the current connections (LAN, RS-232, USB) will be terminated.

Command and Response *#restart #reboot*

- ▶ CALL·/SYS:reset()
- ◀ mO·/SYS:reset=

Example

- ▶ CALL /SYS:reset()
- ◀ mO /SYS:reset=

7.4.9. Restore the Factory Default Settings

Command and Response *#factory*

- ▶ CALL·/SYS:factoryDefaults()
- ◀ mO·/SYS:factoryDefaults=

Example

- ▶ CALL /SYS:factoryDefaults()
- ◀ mO /SYS:factoryDefaults=

The device is restarted, current connections are terminated, and the default settings are restored. See the complete list in the [Factory Default Settings](#) section.

7.5. Video Port Settings

Port Numbering

Video port type	Parameter	Video port	LW3 port number
Input	<in>	TPS in 1	I1
		HDMI in 2	I2
Output	<out>	HDMI out 1	O1
		HDMI out 2	O2

7.5.1. Query the Status of Source Ports

Command and Response #portstatus

- ▶ GET:/MEDIA/VIDEO/XP.SourcePortStatus
- ◀ pr:/MEDIA/VIDEO/XP.SourcePortStatus=<in_state>

The response contains 5 ASCII characters for each port. The first character indicates the mute/lock state, the next four characters represent a 2-byte HEX code showing the current state of the input ports.

Example

- ▶ GET /MEDIA/VIDEO/XP.SourcePortStatus
- ◀ pr /MEDIA/VIDEO/XP.SourcePortStatus=M00AA;T00FF

Parameters

Letter (Character 1)	Mute state		Lock state	
	Mute	Lock	Mute	Lock
T	Unmuted	Unlocked	Unmuted	Unlocked
L	Unmuted	Locked	Unmuted	Locked
M	Muted	Unlocked	Muted	Unlocked
U	Muted	Locked	Muted	Locked

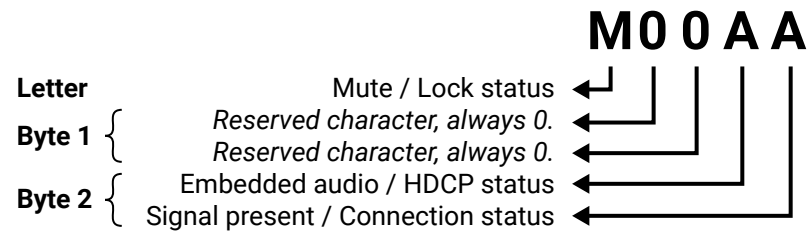

	Byte 1				Byte 2			
	Character 2		Character 3		Character 4		Character 5	
	BIT 7-6	BIT 5-4	BIT 3-2	BIT 1-0	BIT 7-6	BIT 5-4	BIT 3-2	BIT 1-0
	Reserved	Reserved	Reserved	Reserved	Embedded audio status	HDCP status	Signal present status	Connection status
00	Unknown							
01	Reserved							
10	Reserved	Reserved	Reserved	Reserved	No embedded audio	Not encrypted	No signal	Not connected
11					Embedded audio presents	Encrypted	Signal presents	Connected

The Most Common Received Port Status Responses

T00AA	T	00		00		10		10	
	Unlocked, Unmuted	Reserved	Reserved	Reserved	Reserved	No embedded audio	Not encrypted	No signal	Not connected
T00AB	T	00		00		10		11	
	Unlocked, Unmuted	Reserved	Reserved	Reserved	Reserved	No embedded audio	Not encrypted	No signal	Connected
T00AF	T	00		00		10		11	
	Unlocked, Unmuted	Reserved	Reserved	Reserved	Reserved	No embedded audio	Not encrypted	Signal presents	Connected
T00EF	T	00		00		11		11	
	Unlocked, Unmuted	Reserved	Reserved	Reserved	Reserved	Embedded audio presents	Not encrypted	Signal presents	Connected
T00BF	T	00		00		10		11	
	Unlocked, Unmuted	Reserved	Reserved	Reserved	Reserved	No embedded audio	Encrypted	Signal presents	Connected
T00FF	T	00		00		11		11	
	Unlocked, Unmuted	Reserved	Reserved	Reserved	Reserved	Embedded audio presents	Encrypted	Signal presents	Connected

7.5.2. Query the Status of Destination Port

Command and Response *#portstatus*

- ▶ GET·/MEDIA/VIDEO/XP.DestinationPortStatus
- ◀ pr·/MEDIA/VIDEO/XP.DestinationPortStatus=<out_state>

Parameters

<out_state>: the response contains 5 ASCII characters for each port. The first character indicates the mute/lock state, the next 2-byte long HEX code showing the current state of the output port.

Example

- ▶ GET /MEDIA/VIDEO/XP.DestinationPortStatus
- ◀ pr /MEDIA/VIDEO/XP.DestinationPortStatus=M00BF;T00FF

Legend

See at previous section.

Explanation

M	0		0		B		F	
Unlocked, Muted	00	00	00	00	10	11	11	11
	Reserved	Reserved	Reserved	Reserved	No embedded audio	Encrypted	Signal presents	Connected

7.5.3. Query the Video Crosspoint Setting

Command and Response

- ▶ GET·/MEDIA/VIDEO/XP.DestinationConnectionList
- ◀ pr·/MEDIA/VIDEO/XP.DestinationConnectionList=<in>

Example

- ▶ GET /MEDIA/VIDEO/XP.DestinationConnectionList
- ◀ pr /MEDIA/VIDEO/XP.DestinationConnectionList=I1;I2

I1 input port is connected to the O1 output port, I2 input port is connected to the O2 output port.

7.5.4. Switching Video Input to an Output

Command and Response *#switch #crosspoint*

- ▶ CALL·/MEDIA/VIDEO/XP:switch(<in>:<out>)
- ◀ m0·/MEDIA/VIDEO/XP:switch

Example

- ▶ CALL /MEDIA/VIDEO/XP:switch(I2:O1)
- ◀ m0 /MEDIA/VIDEO/XP:switch

I2 port is connected to O1 port.

7.5.5. Switching Video Input to All Outputs

Command and Response

- ▶ CALL·/MEDIA/VIDEO/XP:switchAll(<in>)
- ◀ m0·/MEDIA/VIDEO/XP:switchAll

Example

- ▶ CALL /MEDIA/VIDEO/XP:switchAll(I1)
- ◀ m0 /MEDIA/VIDEO/XP:switchAll

I1 port is connected to the O1 and O2 ports.

7.5.6. Query the Video Autoselect Settings

Command and Response *#autoselect*

- ▶ GET·/MEDIA/VIDEO/XP.DestinationPortAutoselect
- ◀ pr·/MEDIA/VIDEO/XP.DestinationPortAutoselect=<out_set>

The response shows the settings of each output one by one.

Parameters

Identifier	Parameter description	Value	Explanation
<out_set>	Two-letter code of the Autoselect settings 1 st letter	E	Autoselect is enabled .
		D	Autoselect is disabled .
	Two-letter code of the Autoselect settings 2 nd letter	F	First detect mode: the first active video input is selected.
		P	Priority detect: always the highest priority active video input will be selected.
		L	Last detect: always the last attached input is switched to the output automatically.

Example

- ▶ GET /MEDIA/VIDEO/XP.DestinationPortAutoselect
- ◀ pr /MEDIA/VIDEO/XP.DestinationPortAutoselect=EL;DP

Explanation

EL: the Autoselect is **Enabled** on output 1, selected mode is Last detect.

DP: the Autoselect is **Disabled** on output 2.

INFO: For more information see [The Autoselect Feature](#) section.

7.5.7. Change the Autoselect Mode

Command and Response

- ▶ CALL·/MEDIA/VIDEO/XP:setDestinationPortAutoselect(<out>:<out_set>)
- ◀ mO·/MEDIA/VIDEO/XP:setDestinationPortAutoselect

Legend

See the previous section.

Example

- ▶ CALL /MEDIA/VIDEO/XP:setDestinationPortAutoselect(O1:EF)
- ◀ mO /MEDIA/VIDEO/XP:setDestinationPortAutoselect

Explanation

The Autoselect mode is Enabled on Output 1 in First detect mode.

7.5.8. Query the Input Port Priority

Command and Response

- ▶ GET·/MEDIA/VIDEO/XP.PortPriorityList
- ◀ pr·/MEDIA/VIDEO/XP.PortPriorityList=<in1_prio>

Legend

<out_prio>: The input port priority order of the given output port: I1 and I2.

Example

- ▶ GET /MEDIA/VIDEO/XP.PortPriorityList
- ◀ pr /MEDIA/VIDEO/XP.PortPriorityList=0,1;1,0

Explanation

There are two outputs, so there are two groups listed in the response (divided by semicolons) and each group (list) contains two priority numbers.

The response: 0,1;1,0. Those values show the priority order of the video input ports:

Output 1		Output 2	
I1	I2	I1	I2
0	1	1	0

In the above example, the Input 1 has the higher priority on O1 output port and Input 2 has the lower priority. On O2 the setting is the opposite.

ATTENTION! The same priority number can be set to different input ports. When the priority numbers match, the input port with the lowest port number will have the highest priority.

7.5.9. Changing the Input Port Priority

Command and Response

- ▶ CALL·/MEDIA/VIDEO/XP:setAutoselectionPriority(<in>(<out>):<prio>)
- ◀ mO·/MEDIA/VIDEO/XP:setAutoselectionPriority

Legend

Identifier	Parameter description
<prio>	Priority number from 0 to 1, equal numbers are not allowed.

An input port priority can be set on an output port. Many settings can be executed by separating a semicolon (no space), see the example below.

Example

- ▶ CALL /MEDIA/VIDEO/XP:setAutoselectionPriority (I1(O1):1;I2(O1):0;I1(O2):0;I2(O2):1)
- ◀ mO /MEDIA/VIDEO/XP:setAutoselectionPriority

Explanation

The priority order of the inputs for O1 is: I2, I1; the priority order of the inputs for O2 is: I1, I2.

7.5.10. Mute Input

Command and Response #mute

- ▶ CALL·/MEDIA/VIDEO/XP:muteSource(<in>)
- ◀ mO·/MEDIA/VIDEO/XP:muteSource

Example

- ▶ CALL /MEDIA/VIDEO/XP:muteSource(I1)
- ◀ mO /MEDIA/VIDEO/XP:muteSource

7.5.11. Unmute Input

Command and Response #unmute

- ▶ CALL·/MEDIA/VIDEO/XP:unmuteSource(<in>)
- ◀ mO·/MEDIA/VIDEO/XP:unmuteSource

Example

- ▶ CALL /MEDIA/VIDEO/XP:unmuteSource(I1)
- ◀ mO /MEDIA/VIDEO/XP:unmuteSource

7.5.12. Lock Input

Command and Response #lock

- ▶ CALL·/MEDIA/VIDEO/XP:lockSource(<in>)
- ◀ mO·/MEDIA/VIDEO/XP:lockSource

Example

- ▶ CALL /MEDIA/VIDEO/XP:lockSource(I1)
- ◀ mO /MEDIA/VIDEO/XP:lockSource

7.5.13. Unlock Input

Command and Response #unlock

- ▶ CALL·/MEDIA/VIDEO/XP:unlockSource(<in>)
- ◀ mO·/MEDIA/VIDEO/XP:unlockSource

Example

- ▶ CALL /MEDIA/VIDEO/XP:unlockSource(I1)
- ◀ mO /MEDIA/VIDEO/XP:unlockSource

7.5.14. Mute Output

Command and Response #mute

- ▶ CALL·/MEDIA/VIDEO/XP:muteDestination(<out>)
- ◀ mO·/MEDIA/VIDEO/XP:muteDestination

Example

- ▶ CALL /MEDIA/VIDEO/XP:muteDestination(O1)
- ◀ mO /MEDIA/VIDEO/XP:muteDestination

7.5.15. Unmute Output

Command and Response #unmute

- ▶ CALL·/MEDIA/VIDEO/XP:unmuteDestination(<out>)
- ◀ mO·/MEDIA/VIDEO/XP:unmuteDestination

Example

- ▶ CALL /MEDIA/VIDEO/XP:unmuteDestination(O1)
- ◀ mO /MEDIA/VIDEO/XP:unmuteDestination

7.5.16. Lock Output

Command and Response *#lock*

- ▶ CALL /MEDIA/VIDEO/XP:lockDestination(<out>)
- ◀ mO /MEDIA/VIDEO/XP:lockDestination

Example

- ▶ CALL /MEDIA/VIDEO/XP:lockDestination(01)
- ◀ mO /MEDIA/VIDEO/XP:lockDestination

7.5.17. Unlock Output

Command and Response *#unlock*

- ▶ CALL /MEDIA/VIDEO/XP:unlockDestination(<out>)
- ◀ mO /MEDIA/VIDEO/XP:unlockDestination

Example

- ▶ CALL /MEDIA/VIDEO/XP:unlockDestination(01)
- ◀ mO /MEDIA/VIDEO/XP:unlockDestination

7.5.18. HDCP Setting (Input Port)

HDCP capability can be enabled/disabled on the input ports, thus, non-encrypted content can be seen on a non-HDCP compliant display. See more information in the [HDCP Management](#) section.

Command and Response *#hdc*

- ▶ SET /MEDIA/VIDEO/<in>.HdcpEnable=<logical_value>
- ◀ pw /MEDIA/VIDEO/<in>.HdcpEnable=<logical_value>

Parameters

Identifier	Parameter description	Value	Parameter value
<logical_value>	HDCP enable/disable setting	true	HDCP encryption is enabled.
		false	HDCP encryption is disabled.

Example

- ▶ SET /MEDIA/VIDEO/I1.HdcpEnable=false
- ◀ pw /MEDIA/VIDEO/I1.HdcpEnable=false

7.5.19. HDCP Setting (Output Port)

HDCP capability can be set to Auto/Always on the output ports, thus, non-encrypted content can be transmitted to a non-HDCP compliant display. See more information in the [HDCP Management](#) section.

Command and Response *#hdc*

- ▶ SET /MEDIA/VIDEO/<out>.HdcpModeSetting=<HDCP_mode>
- ◀ pw /MEDIA/VIDEO/<out>.HdcpModeSetting=<HDCP_mode>

Parameters

Identifier	Parameter description	Value	Parameter value
<HDCP_mode>	HDCP mode	0	Auto
		1	Always

Example

- ▶ SET /MEDIA/VIDEO/O1.HdcpModeSetting=0
- ◀ pw /MEDIA/VIDEO/O1.HdcpModeSetting=0

7.5.20. Test Pattern Generator Mode

The output port can send a special image towards the sink device for testing purposes. The setting is available on the input ports with the below-listed parameters.

Command and Response *#testpattern #nosyncscreen #diagnostic*

- ▶ SET /MEDIA/VIDEO/<out>.TpgMode=<mode>
- ◀ pw /MEDIA/VIDEO/<out>.TpgMode=<mode>

Parameters

Identifier	Parameter description	Value	Parameter value
<mode>	Test pattern generator mode	0	Always off: the test pattern is not displayed on the output.
		1	Always on: the test pattern is displayed on the output.
		2	Auto: the test pattern is displayed if there is no signal on the input port.

Example

- ▶ SET /MEDIA/VIDEO/O1.TpgMode=2
- ◀ pw /MEDIA/VIDEO/O1.TpgMode=2

7.5.21. Test Pattern Generator Clock Source

Command and Response

- ▶ SET·/MEDIA/VIDEO/<out>.TpgClockSource=<clock_frequency>
- ◀ pw·/MEDIA/VIDEO/<out>.TpgClockSource=<clock_frequency>

Parameters

Identifier	Parameter description	Value	Parameter value
<clock_frequency>	Clock frequency	480	480p
		576	576p
		EXT	External clock (from actual TMDS source)

Example

- ▶ SET /MEDIA/VIDEO/01.TpgClockSource=576
- ◀ pw /MEDIA/VIDEO/01.TpgClockSource=576

7.5.22. Test Pattern Setting

Command and Response

- ▶ SET·/MEDIA/VIDEO/<out>.TpgPattern=<pattern>
- ◀ pw·/MEDIA/VIDEO/<out>.TpgPattern=<pattern>

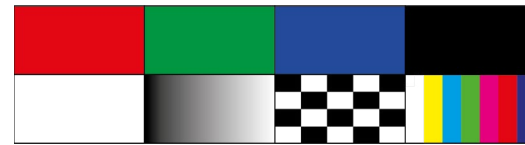

Parameters

Identifier	Parameter description	Value	Parameter value
<pattern>	The test pattern displayed on the sink device	RED	Red
		GREEN	Green
		BLUE	Blue
		BLACK	Black
		WHITE	White
		RAMP	Ramp
		CHESS	Chess
		BAR	Bar
		CYCLE	Cycle setting means all the patterns are changed sequentially approx. in every 2 seconds

Example

- ▶ SET /MEDIA/VIDEO/01.TpgPattern=GREEN
- ◀ pw /MEDIA/VIDEO/01.TpgPattern=GREEN

7.5.23. HDMI Mode Settings (Output Port)

Command and Response #signaltype

- ▶ SET·/MEDIA/VIDEO/<out>.HdmiModeSetting=<mode>
- ◀ pw·/MEDIA/VIDEO/<out>.HdmiModeSetting=<mode>

Parameters

Identifier	Parameter description	Value	Parameter value
<mode>	HDMI mode	0	Auto
		1	DVI
		2	HDMI

Example

- ▶ SET /MEDIA/VIDEO/01.HdmiModeSetting=2
- ◀ pw /MEDIA/VIDEO/01.HdmiModeSetting=2

7.5.24. Query the Recent TPS Mode

Command and Response #tpsmode

- ▶ GET·/REMOTE/<port>.tpsMode
- ◀ pr·/REMOTE/<port>.tpsMode=<TPS_mode>

Parameters

Identifier	Parameter description	Value	Parameter value
<TPS_mode>	TPS mode	A	Auto
		H	HDBaseT
		L	Long reach
		1	LPPF1
		2	LPPF2

Example

- ▶ GET /REMOTE/S1.tpsMode
- ◀ pr /REMOTE/S1.tpsMode=H

See more information about TPS modes in the [TPS Interface](#) section.

7.5.25. TPS Mode Settings

Command and Response

- ▶ SET-/REMOTE/<port>.tpsModeSetting=<TPS_mode>
- ◀ pw-/REMOTE/<port>.tpsModeSetting=<TPS_mode>

Parameters

Identifier	Parameter description	Value	Parameter value
<TPS_mode>	TPS mode	A	Auto
		H	HDBaseT
		L	Long reach
		1	LPPF1
		2	LPPF2

Example

- ▶ SET /REMOTE/S1.tpsModeSetting=A
- ◀ pw /REMOTE/S1.tpsModeSetting=A

See more information about TPS modes in the [TPS Interface](#) section.

7.6. Audio Port Settings

Port Numbering

Audio port type	Parameter	Audio port	LW3 port number
Input	<in>	TPS in 1	I1
		HDMI in 2	I2
		HDMI out 1	O1
Output	<out>	HDMI out 2	O2
		Analog audio out	O3

7.6.1. Query the Status of Source Ports

Command and Response #portstatus

- ▶ GET-/MEDIA/AUDIO/XP.SourcePortStatus
- ◀ pr-/MEDIA/AUDIO/XP.SourcePortStatus=<in_state>

The response contains 5 ASCII characters for each port. The first character indicates the mute/lock state, the next four characters represent a 2-byte HEX code showing the current state of the input port.

Example

- ▶ GET /MEDIA/AUDIO/XP.SourcePortStatus
- ◀ pr /MEDIA/AUDIO/XP.SourcePortStatus=T000F;T000A

Legend:

Letter (Character 1)		Mute / Lock status
T	Unmuted	Unlocked
L	Unmuted	Locked
M	Muted	Unlocked
U	Muted	Locked

Letter	Byte 1	Byte 2	Signal present / Connection status
T	Reserved character, always 0.	Reserved character, always 0.	Signal present / Connection status
O	Reserved character, always 0.	Reserved character, always 0.	Signal present / Connection status
O	Reserved character, always 0.	Reserved character, always 0.	Signal present / Connection status
F	Reserved character, always 0.	Reserved character, always 0.	Signal present / Connection status

	Byte 1				Byte 2			
	Character 2		Character 3		Character 4		Character 5	
	BIT 7-6	BIT 5-4	BIT 3-2	BIT 1-0	BIT 7-6	BIT 5-4	BIT 3-2	BIT 1-0
	Reserved	Reserved	Reserved	Reserved	Reserved	Reserved	Signal present status	Connection status
00							Unknown	
01							Reserved	
10	Reserved	Reserved	Reserved	Reserved	Reserved	Reserved	No signal	Not connected
11							Signal presents	Connected

The Most Common Received Port Status Responses

T000A	T	0		0		0		A	
	Unlocked, Unmuted	00	00	00	00	00	00	10	10
	Reserved	Reserved	Reserved	Reserved	Reserved	Reserved	No signal	Not connected	

T000B	T	0		0		0		B	
	Unlocked, Unmuted	00	00	00	00	00	00	10	11
	Reserved	Reserved	Reserved	Reserved	Reserved	Reserved	No signal	Connected	

T000F	T	0		0		0		F	
	Unlocked, Unmuted	00	00	00	00	00	00	11	11
	Reserved	Reserved	Reserved	Reserved	Reserved	Reserved	Signal presents	Connected	

7.6.2. Query the Status of Destination Port

Command and Response *#portstatus*

- ▶ GET·/MEDIA/AUDIO/XP.DestinationPortStatus
- ◀ pr·/MEDIA/AUDIO/XP.DestinationPortStatus=<out1_state>;<out2_state>

The response contains 5 ASCII characters for each port. The first character indicates the mute/lock state, the next 2-byte long HEX code showing the current state of the output port.

Example

- ▶ GET /MEDIA/AUDIO/XP.DestinationPortStatus
- ◀ pr /MEDIA/AUDIO/XP.DestinationPortStatus=T000F;T000A;T000F

Legend

See at previous section.

Example and Explanation

T	0		0		0		F	
Unlocked, Unmuted	00	00	00	00	00	00	11	11
	Reserved	Reserved	Reserved	Reserved	Reserved	Reserved	Signal presents	Connected

7.6.3. Query the Audio Crosspoint Setting

Command and Response

- ▶ GET·/MEDIA/AUDIO/XP.DestinationConnectionList
- ◀ pr·/MEDIA/AUDIO/XP.DestinationConnectionList=<in>

Example

- ▶ GET /MEDIA/AUDIO/XP.DestinationConnectionList
- ◀ pr /MEDIA/AUDIO/XP.DestinationConnectionList=I1;I2;I1

I1 input port is connected to the O1 and O3 output ports, I2 input port is connected to the O2 output port.

7.6.4. Switching Audio Input to an Output

Command and Response *#switch #crosspoint*

- ▶ CALL·/MEDIA/AUDIO/XP:switch(<in>;<out>)
- ◀ mO·/MEDIA/AUDIO/XP:switch

Example

- ▶ CALL /MEDIA/AUDIO/XP:switch(I2;O3)
- ◀ mO /MEDIA/AUDIO/XP:switch

I2 port is connected to O3 port.

7.6.5. Switching Audio Input to All Outputs

Command and Response

- ▶ CALL·/MEDIA/AUDIO/XP:switchAll(<in>)
- ◀ mO·/MEDIA/AUDIO/XP:switchAll

Example

- ▶ CALL /MEDIA/AUDIO/XP:switchAll(I1)
- ◀ mO /MEDIA/AUDIO/XP:switchAll

I1 port is connected to the O1, O2 and O3 ports.

7.6.6. Query the Audio Autoselect Settings

Command and Response *#autoselect*

- ▶ GET·/MEDIA/AUDIO/XP.DestinationPortAutoselect
- ◀ pr·/MEDIA/AUDIO/XP.DestinationPortAutoselect=<out_set>

The response shows the settings of each output one by one.

Parameters

Identifier	Parameter description	Value	Explanation
<out_set>	Two-letter code of the Autoselect settings 1 st letter	E	Autoselect is enabled .
		D	Autoselect is disabled .
		F	First detect mode: the first active audio input is selected.
	Two-letter code of the Autoselect settings 2 nd letter	P	Priority detect: always the highest priority active video input will be selected.
		L	Last detect: always the last attached input is switched to the output automatically.
		S	Static : the audio input follows the selected video if the video signal contains embedded audio.

Example

- ▶ GET /MEDIA/AUDIO/XP.DestinationPortAutoselect
- ◀ pr /MEDIA/AUDIO/XP.DestinationPortAutoselect=EL;DP;EF

Explanation

EL: the Autoselect is **Enabled** on O1, selected mode is **Last** detect.

DP: the Autoselect is **Disabled** on O2.

EF: the Autoselect is **Enabled** on O3, selected mode is **First** detect.

INFO: For more information see [The Autoselect Feature](#) section.

7.6.7. Change the Autoselect Mode

Command and Response

- ▶ CALL·/MEDIA/AUDIO/XP:setDestinationPortAutoselect(<out>:<out_set>)
- ◀ mO·/MEDIA/AUDIO/XP:setDestinationPortAutoselect

Legend

See the previous section.

Example

- ▶ CALL /MEDIA/AUDIO/XP:setDestinationPortAutoselect(O1:EF;O3:DP)
- ◀ mO /MEDIA/AUDIO/XP:setDestinationPortAutoselect

Explanation

The Autoselect mode is Enabled on Output 1 in First detect mode and it is disabled on the Output 3.

7.6.8. Query the Input Port Priority

Command and Response

- ▶ GET·/MEDIA/AUDIO/XP.PortPriorityList
- ◀ pr·/MEDIA/AUDIO/XP.PortPriorityList=<in1_prio>

Legend

<out_prio>: The input port priority order of the given output port: I1 and I2.

Example

- ▶ GET /MEDIA/AUDIO/XP.PortPriorityList
- ◀ pr /MEDIA/AUDIO/XP.PortPriorityList=0,1;1,0

Explanation

There are two outputs, so there are two groups listed in the response (divided by semicolons) and each group (list) contains two priority numbers.

The response: 0,1;1,0. Those values show the priority order of the audio input ports:

Output 1		Output 2	
I1	I2	I1	I2
0	1	1	0

In the above example, the Input 1 has the higher priority on O1 output port and Input 2 has the lower priority. On O2 the setting is the opposite.

ATTENTION! The same priority number can be set to different input ports. When the priority numbers match, the input port with the lowest port number will have the highest priority.

7.6.9. Changing the Input Port Priority

Command and Response

- ▶ CALL·/MEDIA/AUDIO/XP:setAutoselectionPriority(<in>(<out>):<prio>)
- ◀ mO·/MEDIA/AUDIO/XP:setAutoselectionPriority

Legend

Identifier	Parameter description
<prio>	Priority number from 0 to 1, equal numbers are not allowed.

An input port priority can be set on an output port. Many settings can be executed by separating a semicolon (no space), see the example below.

Example

- ▶ CALL /MEDIA/AUDIO/XP:setAutoselectionPriority (I1(O1):1;I2(O1):0;I1(O3):0;I2(O3):1)
- ◀ mO /MEDIA/AUDIO/XP:setAutoselectionPriority

Explanation

The priority order of the inputs for O1 is: I2, I1; the priority order of the inputs for O3 is: I1, I2.

7.6.10. Mute Input

Command and Response #mute

- ▶ CALL·/MEDIA/AUDIO/XP:muteSource(<in>)
- ◀ mO·/MEDIA/AUDIO/XP:muteSource

Example

- ▶ CALL /MEDIA/AUDIO/XP:muteSource(I1)
- ◀ mO /MEDIA/AUDIO/XP:muteSource

7.6.11. Unmute Input

Command and Response #unmute

- ▶ CALL·/MEDIA/AUDIO/XP:unmuteSource(<in>)
- ◀ mO·/MEDIA/AUDIO/XP:unmuteSource

Example

- ▶ CALL /MEDIA/AUDIO/XP:unmuteSource(I1;I2)
- ◀ mO /MEDIA/AUDIO/XP:unmuteSource

7.6.12. Lock Input

Command and Response #lock

- ▶ CALL·/MEDIA/AUDIO/XP:lockSource(<in>)
- ◀ mO·/MEDIA/AUDIO/XP:lockSource

Example

- ▶ CALL /MEDIA/AUDIO/XP:lockSource(I1)
- ◀ mO /MEDIA/AUDIO/XP:lockSource

7.6.13. Unlock Input

Command and Response #unlock

- ▶ CALL·/MEDIA/AUDIO/XP:unlockSource(<in>)
- ◀ mO·/MEDIA/AUDIO/XP:unlockSource

Example

- ▶ CALL /MEDIA/AUDIO/XP:unlockSource(I1)
- ◀ mO /MEDIA/AUDIO/XP:unlockSource

7.6.14. Mute Output

Command and Response #mute

- ▶ CALL·/MEDIA/AUDIO/XP:muteDestination(<out>)
- ◀ mO·/MEDIA/AUDIO/XP:muteDestination

Example

- ▶ CALL /MEDIA/AUDIO/XP:muteDestination(O1)
- ◀ mO /MEDIA/AUDIO/XP:muteDestination

7.6.15. Unmute Output

Command and Response #unmute

- ▶ CALL·/MEDIA/AUDIO/XP:unmuteDestination(<out>)
- ◀ mO·/MEDIA/AUDIO/XP:unmuteDestination

Example

- ▶ CALL /MEDIA/AUDIO/XP:unmuteDestination(O1)
- ◀ mO /MEDIA/AUDIO/XP:unmuteDestination

7.6.16. Lock Output

Command and Response *#lock*

- ▶ CALL·/MEDIA/AUDIO/XP:lockDestination(<out>)
- ◀ mO·/MEDIA/AUDIO/XP:lockDestination

Example

- ▶ CALL /MEDIA/AUDIO/XP:lockDestination(O1;O2;O3)
- ◀ mO /MEDIA/AUDIO/XP:lockDestination

7.6.17. Unlock Output

Command and Response *#unlock*

- ▶ CALL·/MEDIA/AUDIO/XP:unlockDestination(<out>)
- ◀ mO·/MEDIA/AUDIO/XP:unlockDestination

Example

- ▶ CALL /MEDIA/AUDIO/XP:unlockDestination(O1)
- ◀ mO /MEDIA/AUDIO/XP:unlockDestination

7.7. Analog Audio Output Settings

7.7.1. Volume Setting (dB)

Command and Response *#analogaudio #volume*

- ▶ SET·/MEDIA/AUDIO/<out>.VolumedB=<level>
- ◀ pw·/MEDIA/AUDIO/<out>.VolumedB=<level>

Parameters

- <level> Sets the output volume (attenuation) between -95.625 dB and 0 dB in step of -0.375 dB. The value is rounded up if necessary to match with the step value.

Example

- ▶ SET /MEDIA/AUDIO/O3.VolumedB=-15
- ◀ pw /MEDIA/AUDIO/O3.VolumedB=-15.00

7.7.2. Volume Setting (dB) in Steps

Command and Response

- ▶ CALL·/MEDIA/AUDIO/<out>:stepVolumedB(<step>)
- ◀ mO·/MEDIA/AUDIO/<out>:stepVolumedB

Parameters

- <level> Sets the output volume (attenuation) between -95.625 dB and 0 dB in step of -0.375 dB. The value is rounded up if necessary to match with the step value.

Example

- ▶ CALL /MEDIA/AUDIO/O3:stepVolumedB(5)
- ◀ mO /MEDIA/AUDIO/O3:stepVolumedB

7.7.3. Volume Setting (Percent)

Command and Response

- ▶ SET·/MEDIA/AUDIO/<out>.VolumePercent=<percent>
- ◀ pw·/MEDIA/AUDIO/<out>.VolumePercent=<percent>

Parameters

- <level> Sets the output volume (attenuation) between 100% and 0%, in step of 1%. The value is rounded up if necessary to match with the step value.

Example

- ▶ SET /MEDIA/AUDIO/O3.VolumePercent=50
- ◀ pw /MEDIA/AUDIO/O3.VolumePercent=50

7.7.4. Volume Setting (Percent) in Steps

Command and Response

- ▶ CALL·/MEDIA/AUDIO/<out>:stepVolumePercent(<percent>)
- ◀ pw·/MEDIA/AUDIO/<out>:stepVolumePercent

Parameters

- <level> Sets the output volume (attenuation) between 100% and 0%, in step of 1%. The value is rounded up if necessary to match with the step value.

Example

- ▶ CALL /MEDIA/AUDIO/O3:stepVolumePercent(15)
- ◀ mO /MEDIA/AUDIO/O3:stepVolumePercent

7.7.5. Balance Setting

Command and Response *#balance*

- ▶ SET /MEDIA/AUDIO/<out>.Balance=<level>
- ◀ pw /MEDIA/AUDIO/<out>.Balance=<level>

Parameters

- <level> Sets the balance; -100 means left balance, 100 means right balance, step is 1. Center is 0 (default).

Example

- ▶ SET /MEDIA/AUDIO/O3.Balance=0
- ◀ pw /MEDIA/AUDIO/O3.Balance=0

7.7.6. Balance Setting in Steps

Command and Response

- ▶ CALL /MEDIA/AUDIO/<out>:stepBalance(<level>)
- ◀ mO /MEDIA/AUDIO/<out>:stepBalance

Parameters

- <level> Sets the balance; -100 means left balance, 100 means right balance, step is 1. Center is 0 (default).

Example

- ▶ CALL /MEDIA/AUDIO/O3:stepBalance(1)
- ◀ mO /MEDIA/AUDIO/O3:stepBalance

7.8. Network Configuration

7.8.1. Query the DHCP State

Command and Response *#network #ipaddress #dhcp*

- ▶ GET /MANAGEMENT/NETWORK.DhcpEnabled
- ◀ pw /MANAGEMENT/NETWORK.DhcpEnabled=<logical_value>

Parameters

Identifier	Parameter description	Value	Parameter value
<logical_value>	DHCP (dynamic IP address) setting	true	Dynamic IP address is set.
		false	Fix IP address is set.

Example

- ▶ GET /MANAGEMENT/NETWORK.DhcpEnabled
- ◀ pw /MANAGEMENT/NETWORK.DhcpEnabled=true

7.8.2. Change the DHCP State

Command and Response

- ▶ SET /MANAGEMENT/NETWORK.DhcpEnabled=<logical_value>
- ◀ pw /MANAGEMENT/NETWORK.DhcpEnabled=<logical_value>

Parameters

See the previous section.

Example

- ▶ SET /MANAGEMENT/NETWORK.DhcpEnabled=false
- ◀ pw /MANAGEMENT/NETWORK.DhcpEnabled=false

7.8.3. Query the IP Address

Command and Response

- ▶ GET /MANAGEMENT/NETWORK.IpAddress
- ◀ pr /MANAGEMENT/NETWORK.IpAddress=<IP_Address>

Example

- ▶ GET /MANAGEMENT/NETWORK.IpAddress
- ◀ pr /MANAGEMENT/NETWORK.IpAddress=192.168.0.100

7.8.4. Change the IP Address (Static)

Command and Response

- ▶ SET /MANAGEMENT/NETWORK.StaticIpAddress=<IP_address>
- ◀ pw /MANAGEMENT/NETWORK.StaticIpAddress=<IP_address>

Example

- ▶ SET /MANAGEMENT/NETWORK.StaticIpAddress=192.168.0.85
- ◀ pw /MANAGEMENT/NETWORK.StaticIpAddress=192.168.0.85

7.8.5. Query the Subnet Mask

Command and Response

- ▶ GET /MANAGEMENT/NETWORK.NetworkMask
- ◀ pr /MANAGEMENT/NETWORK.NetworkMask=<netmask>

Example

- ▶ GET /MANAGEMENT/NETWORK.NetworkMask
- ◀ pr /MANAGEMENT/NETWORK.NetworkMask=255.255.255.0

7.8.6. Change the Subnet Mask (Static)

Command and Response

- ▶ SET /MANAGEMENT/NETWORK.StaticNetworkMask=<netmask>
- ◀ pw /MANAGEMENT/NETWORK.StaticNetworkMask=<netmask>

Example

- ▶ SET /MANAGEMENT/NETWORK.StaticNetworkMask=255.255.0.0
- ◀ pw /MANAGEMENT/NETWORK.StaticNetworkMask=255.255.0.0

7.8.7. Query the Gateway Address

Command and Response

- ▶ GET /MANAGEMENT/NETWORK.GatewayAddress
- ◀ pr /MANAGEMENT/NETWORK.GatewayAddress=<gw_address>

Example

- ▶ GET /MANAGEMENT/NETWORK.GatewayAddress
- ◀ pr /MANAGEMENT/NETWORK.GatewayAddress=192.168.0.1

7.8.8. Change the Gateway Address (Static)

Command and Response

- ▶ SET /MANAGEMENT/NETWORK.StaticGatewayAddress=<gw_address>
- ◀ pw /MANAGEMENT/NETWORK.StaticGatewayAddress=<gw_address>

Example

- ▶ SET /MANAGEMENT/NETWORK.StaticGatewayAddress=127.0.0.1
- ◀ pw /MANAGEMENT/NETWORK.StaticGatewayAddress=127.0.0.1

7.8.9. Query the MAC Address

Command and Response

- ▶ GET /MANAGEMENT/NETWORK.MacAddress
- ◀ pr /MANAGEMENT/NETWORK.MacAddress=<MAC_address>

Example

- ▶ GET /MANAGEMENT/NETWORK.MacAddress
- ◀ pr /MANAGEMENT/NETWORK.MacAddress=A8:D2:36:00:43:12

7.8.10. Apply Network Settings

Calling the method results all network settings are applied in the device.

ATTENTION! The command is always requires as the last step for applying the modified network settings.

Command and Response

- ▶ CALL /MANAGEMENT/NETWORK:ApplySettings()
- ◀ mO /MANAGEMENT/NETWORK:ApplySettings

Example

- ▶ CALL /MANAGEMENT/NETWORK:ApplySettings()
- ◀ mO /MANAGEMENT/NETWORK:ApplySettings

7.9. RS-232 Port Configuration

Port Numbering

Serial port	LW3 port number	Parameter
RS-232 (local)	P1	<port>
TPS in 1	P2	

7.9.1. Protocol Setting

Command and Response *#rs232 #rs-232 #serial #protocol #commandinjection*

- ▶ SET /MEDIA/UART/<port>.ControlProtocol=<protocol>
- ◀ pw /MEDIA/UART/<port>.ControlProtocol=<protocol>

Parameters

Identifier	Parameter description	Value	Parameter value
<protocol>	Control protocol which is applied on the selected port	0	LW2 protocol
		1	LW3 protocol

Example

- ▶ SET /MEDIA/UART/P1.ControlProtocol=1
- ◀ pw /MEDIA/UART/P1.ControlProtocol=1

7.9.2. RS-232 Operation Mode

Command and Response

- ▶ SET /MEDIA/UART/<port>.Rs232Mode=<mode>
- ◀ pw /MEDIA/UART/<port>.Rs232Mode=<mode>

Parameters

Identifier	Parameter description	Value	Parameter value
<stopbits>	Stopbits value	0	Pass-through
		1	Control
		2	Command injection

Example

- ▶ SET /MEDIA/UART/P1.Rs232Mode=1
- ◀ pw /MEDIA/UART/P1.Rs232Mode=1

7.9.3. BAUD Rate Setting

Command and Response

- ▶ SET /MEDIA/UART/<port>.Baudrate=<baudrate>
- ◀ pw /MEDIA/UART/<port>.Baudrate=<baudrate>

Parameters

Identifier	Parameter description	Value	Parameter value
<baudrate>	BAUD rate value	0	4800
		1	7200
		2	9600
		3	14400
		4	19200
		5	38400
		6	57600
		7	115200

Example

- ▶ SET /MEDIA/UART/P1.Baudrate=2
- ◀ pw /MEDIA/UART/P1.Baudrate=2

7.9.4. Databits Setting

Command and Response

- ▶ SET /MEDIA/UART/<port>.DataBits=<databits>
- ◀ pw /MEDIA/UART/<port>.DataBits=<databits>

Parameters

Identifier	Parameter description	Value	Parameter value
<databits>	Databits value	8	8
		9	9

Example

- ▶ SET /MEDIA/UART/P1.DataBits=8
- ◀ pw /MEDIA/UART/P1.DataBits=8

7.9.5. Stopbits Setting

Command and Response

- ▶ SET·/MEDIA/UART/<port>.StopBits=<stopbits>
- ◀ pw·/MEDIA/UART/<port>.StopBits=<stopbits>

Parameters

Identifier	Parameter description	Value	Parameter value
		0	1
<stopbits>	Stopbits value	1	1,5
		2	2

Example

- ▶ SET /MEDIA/UART/P1.StopBits=0
- ◀ pw /MEDIA/UART/P1.StopBits=0

7.9.6. Parity Setting

Command and Response

- ▶ SET·/MEDIA/UART/ <port>.Parity=<parity>
- ◀ pw·/MEDIA/UART/<port>.Parity=<parity>

Parameters

Identifier	Parameter description	Value	Parameter value
		0	None
<parity>	Parity setting	1	Odd
		2	Even

Example

- ▶ SET /MEDIA/UART/P1.Parity=0
- ◀ pw /MEDIA/UART/P1.Parity=0

7.9.7. Query the Command Injection Mode

Command and Response

- ▶ GET·/MEDIA/UART/<port>.CommandInjectionStatus
- ◀ pr·/MEDIA/UART/<port>.CommandInjectionStatus=<logical_value>

Parameters

Identifier	Parameter description	Value	Parameter value
<logical_value>	Command injection mode status	true	Command injection mode is enabled.
		false	Command injection mode is disabled.

Example

- ▶ SET /MEDIA/UART/P1.CommandInjection=true
- ◀ pw /MEDIA/UART/P1.CommandInjectionEnable=true

7.9.8. Change the Command Injection Mode

Command and Response

- ▶ SET·/MEDIA/UART/<port>.CommandInjectionEnable=<logical_value>
- ◀ pw·/MEDIA/UART/<port>.CommandInjectionEnable=<logical_value>

Parameters

Identifier	Parameter description	Value	Parameter value
<logical_value>	Command injection mode setting	true	Command injection mode is enabled.
		false	Command injection mode is disabled.

Example

- ▶ SET /MEDIA/UART/P1.CommandInjectionEnable=true
- ◀ pw /MEDIA/UART/P1.CommandInjectionEnable=true

ATTENTION! The local RS-232 and TPS serial link are mirrored. If you change the RS-232 mode on P1 (local) port, the P2 (TPS serial link) will also be changed.

7.10.5. Query the Last Recognized Serial Message in Hex Format

The recognized data is stored in hex format. They are stored until the next incoming message or until the RECOGNIZER:clear() method is called.

TIPS AND TRICKS: When one of these properties are set as a condition in the Event Manager, and the same strings follow each other, the action **will execute once**.

Command and Response

- ▶ GET·/MEDIA/UART/RECOGNIZER.RxHex
- ◀ pr·/MEDIA/UART/RECOGNIZER.RxHex=<recognized _hex>

Parameters

<recognized _hex> Recognized data in hex format.

Example

- ▶ GET /MEDIA/UART/RECOGNIZER.RxHex
- ◀ pr /MEDIA/UART/RECOGNIZER.RxHex=FF1F4C6F67696E3A

7.10.6. Query the Last Recognized Serial Message in Hash Format

The recognized data is stored in hash format. They are stored until the next incoming message or until the RECOGNIZER:clear() method is called.

TIPS AND TRICKS: When one of these properties are set as a condition in the Event Manager, and the same strings follow each other, the action **will execute once**.

Command and Response

- ▶ GET·/MEDIA/UART/RECOGNIZER.Hash
- ◀ pr·/MEDIA/UART/RECOGNIZER.Hash=<recognized _hash>

Parameters

<recognized _hash> Fingerprint code, Max. 32 bit-long recognized data hash.

Example

- ▶ GET /MEDIA/UART/RECOGNIZER.Hash
- ◀ pr /MEDIA/UART/RECOGNIZER.Hash=997A659E

7.10.7. Clear the Stored Last Recognized Serial Message

This method deletes all the stored received serial messages.

Command and Response

- ▶ CALL·/MEDIA/UART/RECOGNIZER:clear()
- ◀ mO·/MEDIA/UART/RECOGNIZER:clear

Example

- ▶ CALL /MEDIA/UART/RECOGNIZER:clear()
- ◀ mO /MEDIA/UART/RECOGNIZER:clear

7.10.8. Query the Last Recognized Serial Message in String Format

The recognized data is stored in string, hex and hash format in a **temporary** storage. They are erased when the Active Timeout elapsed.

TIPS AND TRICKS: When these properties are set as a condition in the Event Manager, and the same strings follow each other, the action **will execute every occasion** if the active timeout set properly.

Command and Response

- ▶ GET·/MEDIA/UART/RECOGNIZER.ActiveRx
- ◀ pr·/MEDIA/UART/RECOGNIZER.ActiveRx=<recognized _string>

Parameters

<recognized _string> Max. 12 byte-long recognized data string.

Example

- ▶ GET /MEDIA/UART/RECOGNIZER.ActiveRx
- ◀ pr /MEDIA/UART/RECOGNIZER.ActiveRx>Login:

7.10.9. Query the Last Recognized Serial Message in Hex Format

The recognized data is stored in string, hex and hash format in a **temporary** storage. They are erased when the Active Timeout elapsed.

TIPS AND TRICKS: When these properties are set as a condition in the Event Manager, and the same strings follow each other, the action **will execute every occasion** if the active timeout set properly.

Command and Response

- ▶ GET /MEDIA/UART/RECOGNIZER.ActiveRxHex
- ◀ pr /MEDIA/UART/RECOGNIZER.ActiveRxHex=<recognized_hex>

Parameters

<recognized_hex> Recognized data in hex format.

Example

- ▶ GET /MEDIA/UART/RECOGNIZER.ActiveRxHex
- ◀ pr /MEDIA/UART/RECOGNIZER.ActiveRxHex= 4C6F67696E3A

7.10.10. Query the Last Recognized Serial Message in Hash Format

The recognized data is stored in string, hex and hash format in a **temporary** storage. They are erased when the Active Timeout elapsed.

TIPS AND TRICKS: When these properties are set as a condition in the Event Manager, and the same strings follow each other, the action **will execute every occasion** if the active timeout set properly.

Command and Response

- ▶ GET /MEDIA/UART/RECOGNIZER.ActiveHash
- ◀ pr /MEDIA/UART/RECOGNIZER.ActiveHash=<recognized_hash>

Parameters

<recognized_hash> Fingerprint code, Max. 32 bit-long recognized data hash.

Example

- ▶ GET /MEDIA/UART/RECOGNIZER.ActiveHash
- ◀ pr /MEDIA/UART/RECOGNIZER.ActiveHash= 2D8A5E38

7.10.11. Set the Active Timeout

This property is responsible for erasing the temporary storage (ActiveRx, ActiveRxHex, ActiveHash) after the elapsing time. Default value is 50ms.

Command and Response

- ▶ SET /MEDIA/UART/RECOGNIZER.ActivePropertyTimeout=<a_timeout>
- ◀ pw /MEDIA/UART/RECOGNIZER.ActivePropertyTimeout=<a_timeout>

Parameters

<a_timeout> Active timeout value (ms) between 0 and 255.

Example

- ▶ SET /MEDIA/UART/RECOGNIZER.ActivePropertyTimeout=255
- ◀ pw /MEDIA/UART/RECOGNIZER.ActivePropertyTimeout=255

7.11. Infrared Port Configuration

Port Numbering

Infrared port type	Parameter	Infrared port	LW3 port number
Input	<in>	IR in (local)	S1
		TPS in 1 (IR in)	S2
Output	<out>	IR out (local)	D1
		TPS in 1 (IR out)	D2

7.11.1. Enable Command Injection Mode

Command and Response *#infra #infrared*

- ▶ SET /MEDIA/IR/<in|out>.CommandInjectionEnable=<logical_value>
- ◀ pw /MEDIA/IR/<in|out>.CommandInjectionEnable=<logical_value>

Parameters

Identifier	Parameter description	Value	Explanation
<logical_value>	Command injection setting	true	Command injection is enabled.
		false	Command injection is disabled.

Example

- ▶ SET /MEDIA/IR/S1.CommandInjectionEnable=true
- ◀ pw /MEDIA/IR/S1.CommandInjectionEnable=true

7.11.2. Change Command Injection Port Number

Command and Response

- ▶ SET /MEDIA/IR/<in|out>.CommandInjectionPort=<port_no>
- ◀ pw /MEDIA/IR/<in|out>.CommandInjectionPort=<port_no>

Example

- ▶ SET /MEDIA/IR/S1.CommandInjectionPort=9001
- ◀ pw /MEDIA/IR/S1.CommandInjectionPort=9001

7.11.3. Enable/Disable Output Signal Modulation

Command and Response

- ▶ SET /MEDIA/IR/<out>.EnableModulation=<logical_value>
- ◀ pw /MEDIA/IR/<out>.EnableModulation=<logical_value>

Parameters

Identifier	Parameter description	Value	Explanation
<logical_value>	Signal modulation enable/disable setting	true	The signal modulation is enabled.
		false	The signal modulation is disabled.

Example

- ▶ SET /MEDIA/IR/D1.EnableModulation=false
- ◀ pw /MEDIA/IR/D1.EnableModulation=false

Signal modulation is turned off on IR output (D1).

■ INFO: The default setting value is **true** (enabled).

7.12. Sending Message via the Communication Ports

7.12.1. Sending a TCP Message (ASCII-format) via TCP Port

The command is for sending a command message in ASCII-format. This method allows escaping the control characters. For more information see the [Escaping](#) section.

Command and Response *#message*

- ▶ CALL /MEDIA/ETHERNET:tcpMessage(<IP_address>:<port_no>=<message>)
- ◀ mO /MEDIA/ETHERNET:tcpMessage

Example

- ▶ CALL /MEDIA/ETHERNET:tcpMessage(192.168.0.103:6107=C00)
- ◀ mO /MEDIA/ETHERNET:tcpMessage

The 'C00' message is sent to the indicated IP:port address.

Example with HEX codes

- ▶ CALL /MEDIA/ETHERNET:tcpMessage(192.168.0.20:5555=C00\x0a\x0d)
- ◀ mO /MEDIA/ETHERNET:tcpMessage

The 'C00' message with CrLf (Carriage return and Line feed) is sent to the indicated IP:port address. The \x sequence indicates the HEXA code; see more information in the [Using Hexadecimal Codes](#) section.

7.12.2. Sending a TCP Text (ASCII-format) via TCP Port

The command is for sending a text message in ASCII-format. This method **does not allow** sending message with control and non-printable characters.

Command and Response

- ▶ CALL /MEDIA/ETHERNET:tcpText(<IP_address>:<port_no>=<text>)
- ◀ mO /MEDIA/ETHERNET:tcpText

Example

- ▶ CALL /MEDIA/ETHERNET:tcpText(192.168.0.103:6107=pwr_on)
- ◀ mO /MEDIA/ETHERNET:tcpText

Explanation

The 'pwr_on' text is sent to the indicated IP:port address.

7.12.3. Sending a TCP Binary Message (HEX-format) via TCP Port

The command is for sending a binary message in Hexadecimal format. This method **does not require escaping** the control and non-printable characters.

Command and Response

- ▶ CALL·/MEDIA/ETHERNET:tcpBinary(<IP_address>:<port_no>=<HEX_message>)
- ◀ mO·/MEDIA/ETHERNET:tcpBinary

Example

- ▶ CALL /MEDIA/ETHERNET:tcpBinary(192.168.0.103:6107=0100000061620000cdcc2c40)
- ◀ mO /MEDIA/ETHERNET:tcpBinary

Explanation

The '0100000061620000cdcc2c40' message is sent to the indicated IP:port address.

■ INFO: There is no need to insert a space or other separator character between the binary messages.

7.12.4. Sending UDP Message (ASCII-format) via TCP Port

The command is for sending a UDP message in ASCII-format. This method **allows** escaping the control characters. For more information see the [Escaping](#) section.

Command and Response

- ▶ CALL·/MEDIA/ETHERNET:udpMessage(<IP_address>:<port_no>=<message>)
- ◀ mO·/MEDIA/ETHERNET:udpMessage

Example

- ▶ CALL /MEDIA/ETHERNET:udpMessage(192.168.0.103:6107=C00)
- ◀ mO /MEDIA/ETHERNET:udpMessage

The 'C00' message is sent to the indicated IP:port address.

Example with HEX codes

- ▶ CALL /MEDIA/ETHERNET:udpMessage(192.168.0.20:9988=C00\x0a\x0d)
- ◀ mO /MEDIA/ETHERNET:udpMessage

The 'C00' message with CrLf (Carriage return and Line feed) is sent to the indicated IP:port address. The \x sequence indicates the HEXA code; see more information in the [Using Hexadecimal Codes](#) section.

7.12.5. Sending a TCP Text (ASCII-format) via TCP Port

The command is for sending a text message in ASCII-format via UDP-protocol. This method **does not allow** sending message with control and non-printable characters.

Command and Response

- ▶ CALL·/MEDIA/ETHERNET:udpText(<IP_address>:<port_no>=<text>)
- ◀ mO·/MEDIA/ETHERNET:udpText

Example

- ▶ CALL /MEDIA/ETHERNET:udpText(192.168.0.20:9988=open)
- ◀ mO /MEDIA/ETHERNET:udpText

The 'open' text is sent to the indicated IP:port address.

7.12.6. Sending a UDP Binary Message (HEX-format) via TCP Port

The command is for sending a binary message in Hexadecimal format via UDP protocol. This method **does not require escaping** the control and non-printable characters.

Command and Response

- ▶ CALL·/MEDIA/ETHERNET:udpBinary(<IP_address>:<port_no>=<HEX_message>)
- ◀ mO·/MEDIA/ETHERNET:udpBinary

Example

- ▶ CALL /MEDIA/ETHERNET:udpBinary(192.168.0.20:9988=433030)
- ◀ mO /MEDIA/ETHERNET:udpBinary

The '433030' message is sent to the indicated IP:port address.

■ INFO: There is no need to insert a space or other separator character between the binary messages.

7.12.7. Sending a Message (ASCII-format) via Serial Port

The command is for sending a command message in ASCII-format. This method **allows** escaping the control characters. For more information see the [Escaping](#) section.

Command and Response

- ▶ CALL·/MEDIA/UART/<port>:sendMessage(<message>)
- ◀ mO·/MEDIA/UART/<port>:sendMessage

Example

- ▶ CALL /MEDIA/UART/P1:sendMessage(PWR0)
- ◀ mO /MEDIA/UART/P1:sendMessage

The 'PWR0' message is sent out via the P1 serial port.

7.13.2. Sending a CEC Command in Text Format

Command and Response

- ▶ CALL /MEDIA/CEC/<port>:send(<command>)
- ◀ mO /MEDIA/CEC/<port>:send

Parameters

The followings are accepted as <command>:

image_view_on	standby	ok	back	up
down	left	right	root_menu	setup_menu
contents_menu	favorite_menu	media_top_menu	media_context_menu	number_0
number_1	number_2	number_3	number_4	number_5
number_6	number_7	number_8	number_9	dot
enter	clear	channel_up	channel_down	sound_select
input_select	display_info	power_legacy	page_up	page_down
volume_up	volume_down	mute_toggle	mute	unmute
play	stop	pause	record	rewind
fast_forward	eject	skip_forward	skip_backward	3d_mode
stop_record	pause_record	play_forward	play_reverse	select_next_media
select_media_1	select_media_2	select_media_3	select_media_4	select_media_5
power_toggle	power_on	power_off	stop_function	f1
f2	f3	f4		

Example

- ▶ CALL /MEDIA/CEC/O1:send(power_on)
- ◀ mO /MEDIA/CEC/O1:send

7.13.3. Sending a CEC Command in Hexadecimal Format

Command and Response

- ▶ CALL /MEDIA/CEC/<port>:sendHex(<hex_code>)
- ◀ mO /MEDIA/CEC/<port>:sendHex

Parameters

<hex_code> Accepted command is max. 30 character long (15 byte) in hexadecimal format.

Example

- ▶ CALL /MEDIA/CEC/I1:sendHex(8700E091)
- ◀ mO /MEDIA/CEC/I1:sendHex

7.14. EDID Management

Parameters

Parameter	Description
<emulated>	The emulated EDID memory of the desired input port. Example: E1.
<dynamic>	Dynamic EDID memory index. Example: D1
<user>	User EDID memory index. Example: U1
<factory>	Factory EDID memory index. Example: F1

See the list of all factory EDID tracks in the [Factory EDID List](#) section.

7.14.1. Query the Emulated EDIDs

Command and Response #edid

- ▶ GET /EDID.EdidStatus
- ◀ pr /EDID.EdidStatus=<dynamic|user|factory>:<emulated>;...;<dynamic|user|factory>:<emulated>

Example

- ▶ GET /EDID.EdidStatus
- ◀ pr /EDID.EdidStatus=D1:E1;F47:E2

Emulated EDID memory for input port is listed with the EDID number that is currently emulated on the input.

7.14.2. Query the Validity of a Dynamic EDID

Command and Response

- ▶ GET /EDID/D/<dynamic>.Validity
- ◀ pr /EDID/D/<dynamic>.Validity=<logical_value>

Parameters

The <logical_value> can be **true** or **false**.

Example

- ▶ GET /EDID/D/D1.Validity
- ◀ pr /EDID/D/D1.Validity=true

7.14.3. Query the Preferred Resolution of an User EDID

Command and Response

- ▶ GET·/EDID/U/<user>.PreferredResolution
- ◀ pr·/EDID/U/<user>.PreferredResolution=<resolution>

Example

- ▶ GET /EDID/U/U2.PreferredResolution
- ◀ pr /EDID/U/U2.PreferredResolution=1920x1080p60.00Hz

7.14.4. Emulating an EDID to an Input Port

Command and Response

- ▶ CALL·/EDID:switch(<dynamic|user|factory>:<emulated>)
- ◀ mO·/EDID:switch

Example

- ▶ CALL /EDID:switch(F49:E1;F27:E2)
- ◀ mO /EDID:switch

7.14.5. Emulating an EDID to All Input Ports

Command and Response

- ▶ CALL·/EDID:switchAll(<dynamic|user|factory>)
- ◀ mO·/EDID:switchAll

Example

- ▶ CALL /EDID:switchAll(F47)
- ◀ mO /EDID:switchAll

7.14.6. Copy an EDID to User Memory

Command and Response

- ▶ CALL·/EDID:copy(<dynamic|emulated|factory|user>:<user>)
- ◀ mO·/EDID:copy

Example

- ▶ CALL /EDID:copy(D1:U1)
- ◀ mO /EDID:copy

The EDID of the last connected sink of D1 (Output 1) has been copied to U1.

7.14.7. Deleting an EDID from User Memory

Command and Response

- ▶ CALL·/EDID:delete(<user>)
- ◀ mO·/EDID:delete

Example

- ▶ CALL /EDID:delete(U1;U2;U6)
- ◀ mO /EDID:delete

7.14.8. Resetting the Emulated EDIDs

Command and Response

- ▶ CALL·/EDID:reset()
- ◀ mO·/EDID:reset

Example

- ▶ CALL /EDID:reset()
- ◀ mO /EDID:reset

Calling this method switches all emulated EDIDs to factory default one. See the table in the [Factory Default Settings](#) section.

7.15. LW3 Protocol Commands - Quick Summary

System Commands

Query the Product Name

- ▶ GET·/.ProductName

Set the Device Label

- ▶ SET·/MANAGEMENT/UID/DeviceLabel=<Custom_name>

Query the Serial Number

- ▶ GET·/.SerialNumber

Query the Firmware Version

- ▶ GET·/SYS/MB.FirmwareVersion

Identify the Device

- ▶ CALL·/MANAGEMENT/UI:identifyMe()

Dark Mode

- ▶ SET·/MANAGEMENT/UI/DARKMODE.DarkModeEnable=<logical_value>

Control Lock

- ▶ SET·/MANAGEMENT/UI.ControlLock=<mode>

Restarting the Device

- ▶ CALL·/SYS:reset()

Restore the Factory Default Settings

- ▶ CALL·/SYS:factoryDefaults()

Video Port Settings

Query the Status of Source Ports

- ▶ GET·/MEDIA/VIDEO/XP.SourcePortStatus

Query the Status of Destination Port

- ▶ GET·/MEDIA/VIDEO/XP.DestinationPortStatus

Query the Video Crosspoint Setting

- ▶ GET·/MEDIA/VIDEO/XP.DestinationConnectionList

Switching Video Input to an Output

- ▶ CALL·/MEDIA/VIDEO/XP:switch(<in>:<out>)

Switching Video Input to All Outputs

- ▶ CALL·/MEDIA/VIDEO/XP:switchAll(<in>)

Query the Video Autoselect Settings

- ▶ GET·/MEDIA/VIDEO/XP.DestinationPortAutoselect

Change the Autoselect Mode

- ▶ CALL·/MEDIA/VIDEO/XP:setDestinationPortAutoselect(<out>:<out_set>)

Query the Input Port Priority

- ▶ GET·/MEDIA/VIDEO/XP.PortPriorityList

Changing the Input Port Priority

- ▶ CALL·/MEDIA/VIDEO/XP:setAutoselectionPriority(<in>(<out>):<prio>)

Mute Input

- ▶ CALL·/MEDIA/VIDEO/XP:muteSource(<in>)

Unmute Input

- ▶ CALL·/MEDIA/VIDEO/XP:unmuteSource(<in>)

Lock Input

- ▶ CALL·/MEDIA/VIDEO/XP:lockSource(<in>)

Unlock Input

- ▶ CALL·/MEDIA/VIDEO/XP:unlockSource(<in>)

Mute Output

- ▶ CALL·/MEDIA/VIDEO/XP:muteDestination(<out>)

Unmute Output

- ▶ CALL·/MEDIA/VIDEO/XP:unmuteDestination(<out>)

Lock Output

- ▶ CALL·/MEDIA/VIDEO/XP:lockDestination(<out>)

Unlock Output

- ▶ CALL·/MEDIA/VIDEO/XP:unlockDestination(<out>)

HDCP Setting (Input Port)

- ▶ SET·/MEDIA/VIDEO/<in>.HdcpEnable=<logical_value>

HDCP Setting (Output Port)

- ▶ SET·/MEDIA/VIDEO/<out>.HdcpModeSetting=<HDCP_mode>

Test Pattern Generator Mode

- ▶ SET·/MEDIA/VIDEO/<out>.TpgMode=<mode>

Test Pattern Generator Clock Source

- ▶ SET·/MEDIA/VIDEO/<out>.TpgClockSource=<clock_frequency>

Test Pattern Setting

- ▶ SET·/MEDIA/VIDEO/<out>.TpgPattern=<pattern>

HDMI Mode Settings (Output Port)

- ▶ SET·/MEDIA/VIDEO/<out>.HdmiModeSetting=<mode>

Query the Recent TPS Mode

- ▶ GET·/REMOTE/<port>.tpsMode

TPS Mode Settings

- ▶ SET·/REMOTE/<port>.tpsModeSetting=<TPS_mode>

Audio Port Settings**Query the Status of Source Ports**

- ▶ GET·/MEDIA/AUDIO/XP.SourcePortStatus

Query the Status of Destination Port

- ▶ GET·/MEDIA/AUDIO/XP.DestinationPortStatus

Query the Audio Crosspoint Setting

- ▶ GET·/MEDIA/AUDIO/XP.DestinationConnectionList

Switching Audio Input to an Output

- ▶ CALL·/MEDIA/AUDIO/XP:switch(<in>:<out>)

Switching Audio Input to All Outputs

- ▶ CALL·/MEDIA/AUDIO/XP:switchAll(<in>)

Query the Audio Autoselect Settings

- ▶ GET·/MEDIA/AUDIO/XP.DestinationPortAutoselect

Change the Autoselect Mode

- ▶ CALL·/MEDIA/AUDIO/XP:setDestinationPortAutoselect(<out>:<out_set>)

Query the Input Port Priority

- ▶ GET·/MEDIA/AUDIO/XP.PortPriorityList

Changing the Input Port Priority

- ▶ CALL·/MEDIA/AUDIO/XP:setAutoselectionPriority(<in>(<out>):<prio>)

Mute Input

- ▶ CALL·/MEDIA/AUDIO/XP:muteSource(<in>)

Unmute Input

- ▶ CALL·/MEDIA/AUDIO/XP:unmuteSource(<in>)

Lock Input

- ▶ CALL·/MEDIA/AUDIO/XP:lockSource(<in>)

Unlock Input

- ▶ CALL·/MEDIA/AUDIO/XP:unlockSource(<in>)

Mute Output

- ▶ CALL·/MEDIA/AUDIO/XP:muteDestination(<out>)

Unmute Output

- ▶ CALL·/MEDIA/AUDIO/XP:unmuteDestination(<out>)

Lock Output

- ▶ CALL·/MEDIA/AUDIO/XP:lockDestination(<out>)

Unlock Output

- ▶ CALL·/MEDIA/AUDIO/XP:unlockDestination(<out>)

Analog Audio Output Settings**Volume Setting (dB)**

- ▶ SET·/MEDIA/AUDIO/<out>.VolumedB=<level>

Volume Setting (dB) in Steps

- ▶ CALL·/MEDIA/AUDIO/<out>.stepVolumedB(<step>)

Volume Setting (Percent)

- ▶ SET·/MEDIA/AUDIO/<out>.VolumePercent=<percent>

Volume Setting (Percent) in Steps

- ▶ CALL·/MEDIA/AUDIO/<out>.stepVolumePercent(<percent>)

Balance Setting

- ▶ SET·/MEDIA/AUDIO/<out>.Balance=<level>

Balance Setting in Steps

- ▶ CALL·/MEDIA/AUDIO/<out>.stepBalance(<level>)

Network Configuration**Query the DHCP State**

- ▶ GET·/MANAGEMENT/NETWORK.DhcpEnabled

Change the DHCP State

- ▶ SET·/MANAGEMENT/NETWORK.DhcpEnabled=<logical_value>

Query the IP Address

- ▶ GET·/MANAGEMENT/NETWORK.IpAddress

Change the IP Address (Static)

- ▶ SET·/MANAGEMENT/NETWORK.StaticIpAddress=<IP_address>

Query the Subnet Mask

- ▶ GET·/MANAGEMENT/NETWORK.NetworkMask

Change the Subnet Mask (Static)

- ▶ SET·/MANAGEMENT/NETWORK.StaticNetworkMask=<netmask>

Query the Gateway Address

- ▶ GET·/MANAGEMENT/NETWORK.GatewayAddress

Change the Gateway Address (Static)

- ▶ SET·/MANAGEMENT/NETWORK.StaticGatewayAddress=<gw_address>

Query the MAC Address

- ▶ GET·/MANAGEMENT/NETWORK.MacAddress

Apply Network Settings

- ▶ CALL·/MANAGEMENT/NETWORK.ApplySettings()

RS-232 Port Configuration**Protocol Setting**

- ▶ SET·/MEDIA/UART/<port>.ControlProtocol=<protocol>

RS-232 Operation Mode

- ▶ SET·/MEDIA/UART/<port>.Rs232Mode=<mode>

BAUD Rate Setting

- ▶ SET·/MEDIA/UART/<port>.Baudrate=<baudrate>

Databits Setting

- ▶ SET·/MEDIA/UART/<port>.DataBits=<databits>

Stopbits Setting

- ▶ SET·/MEDIA/UART/<port>.StopBits=<stopbits>

Parity Setting

- ▶ SET·/MEDIA/UART/<port>.Parity=<parity>

Query the Command Injection Mode

- ▶ GET·/MEDIA/UART/<port>.CommandInjectionStatus

Change the Command Injection Mode

- ▶ SET·/MEDIA/UART/<port>.CommandInjectionEnable=<logical_value>

RS-232 Recognizer**Enable the Recognizer**

- ▶ SET·/MEDIA/UART/<port>.RecognizerEnable=<logical_value>

Set the Delimiter Hex

- ▶ SET·/MEDIA/UART/RECOGNIZER.DelimiterHex=<delimiter>

Set the Timeout

- ▶ SET·/MEDIA/UART/RECOGNIZER.TimeOut=<timeout>

Query the Last Recognized Serial Message in String Format

- ▶ GET·/MEDIA/UART/RECOGNIZER.Rx

Query the Last Recognized Serial Message in Hex Format

- ▶ GET·/MEDIA/UART/RECOGNIZER.RxHex

Query the Last Recognized Serial Message in Hash Format

- ▶ GET·/MEDIA/UART/RECOGNIZER.Hash

Clear the Stored Last Recognized Serial Message

- ▶ CALL·/MEDIA/UART/RECOGNIZER:clear()

Query the Last Recognized Serial Message in String Format

- ▶ GET·/MEDIA/UART/RECOGNIZER.ActiveRx

Query the Last Recognized Serial Message in Hex Format

- ▶ GET·/MEDIA/UART/RECOGNIZER.ActiveRxHex

Query the Last Recognized Serial Message in Hash Format

- ▶ GET·/MEDIA/UART/RECOGNIZER.ActiveHash

Set the Active Timeout

- ▶ SET·/MEDIA/UART/RECOGNIZER.ActivePropertyTimeout=<a_timeout>

Infrared Port Configuration

Enable Command Injection Mode

- ▶ SET·/MEDIA/IR/<in|out>.CommandInjectionEnable=<logical_value>

Change Command Injection Port Number

- ▶ SET·/MEDIA/IR/<in|out>.CommandInjectionPort=<port_no>

Enable/Disable Output Signal Modulation

- ▶ SET·/MEDIA/IR/<out>.EnableModulation=<logical_value>

Sending Message via the Communication Ports

Sending a TCP Message (ASCII-format) via TCP Port

- ▶ CALL·/MEDIA/ETHERNET:tcpMessage(<IP_address>:<port_no>=<message>)

Sending a TCP Text (ASCII-format) via TCP Port

- ▶ CALL·/MEDIA/ETHERNET:tcpText(<IP_address>:<port_no>=<text>)

Sending a TCP Binary Message (HEX-format) via TCP Port

- ▶ CALL·/MEDIA/ETHERNET:tcpBinary(<IP_address>:<port_no>=<HEX_message>)

Sending UDP Message (ASCII-format) via TCP Port

- ▶ CALL·/MEDIA/ETHERNET:udpMessage(<IP_address>:<port_no>=<message>)

Sending a TCP Text (ASCII-format) via TCP Port

- ▶ CALL·/MEDIA/ETHERNET:udpText(<IP_address>:<port_no>=<text>)

Sending a UDP Binary Message (HEX-format) via TCP Port

- ▶ CALL·/MEDIA/ETHERNET:udpBinary(<IP_address>:<port_no>=<HEX_message>)

Sending a Message (ASCII-format) via Serial Port

- ▶ CALL·/MEDIA/UART/<port>:sendMessage(<message>)

Sending a Text (ASCII-format) via Serial Port

- ▶ CALL·/MEDIA/UART/<port>:sendText(<message>)

Sending a Binary Message (HEX-format) via Serial Port

- ▶ CALL·/MEDIA/UART/<port>:sendBinaryMessage(<message>)

Sending Pronto Hex Codes in Little-endian Format via IR Port

- ▶ CALL·/MEDIA/IR/<output_port>:sendProntoHex(<hex_code>)

Sending Pronto Hex Codes in Big-endian Format via IR Port

- ▶ CALL·/MEDIA/IR/<output_port>:sendProntoHexBigEndian(<hex_code>)

Sending CEC Commands

Sending an OSD String

- ▶ SET·/MEDIA/CEC/<port>.OsdString=<text>
- ▶ CALL·/MEDIA/CEC/<port>:send(set_osd)

Sending a CEC Command in Text Format

- ▶ CALL /MEDIA/CEC/<port>:send(<command>)

Sending a CEC Command in Hexadecimal Format

- ▶ CALL /MEDIA/CEC/<port>:sendHex(<hex_code>)

EDID Management

Query the Emulated EDIDs

- ▶ GET·/EDID.EdidStatus

Query the Validity of a Dynamic EDID

- ▶ GET·/EDID/D/<dynamic>.Validity

Query the Preferred Resolution of an User EDID

- ▶ GET·/EDID/U/<user>.PreferredResolution

Emulating an EDID to an Input Port

- ▶ CALL·/EDID:switch(<dynamic|user|factory>:<emulated>)

Emulating an EDID to All Input Ports

- ▶ CALL·/EDID:switchAll(<dynamic|user|factory>)

Copy an EDID to User Memory

- ▶ CALL·/EDID:copy(<dynamic|emulated|factory|user>:<user>)

Deleting an EDID from User Memory

- ▶ CALL·/EDID:delete(<user>)





Resetting the Emulated EDIDs

- ▶ CALL·/EDID:reset()

8

Troubleshooting

Usually, if the system seems not to transport the signal as expected, the best strategy for troubleshooting is to check signal integrity through the whole signal chain starting from source side and moving forward to receiver end.















-  Link to connections/cabling section.
-  Link to front panel operation section.
-  Link to LDC software section.
-  Link to LW2 protocol commands section.
-  Link to LW3 protocol commands section.





















The following sections are available in the chapter:









- ▶ [USE CASE STUDIES](#)
- ▶ [HOW TO SPEED UP THE TROUBLESHOOTING PROCESS](#)

8.1. Use Case Studies

At first, check front panel LEDs and take the necessary steps according to their states. For more information about status, LEDs refer to the [Status LEDs and Button Functions](#) section. *#diagnostic*

Symptom	Root cause	Action	Refer to
Video signal			
No picture on the video output	Device or devices are not powered properly	Check the receiver and the other devices if they are properly powered; try to unplug and reconnect them.	 3.2.1
	Cable connection problem	Cables must fit very well, check all the connectors (video and TPS cables).	 3.2
	No incoming signal	If the TPS LINK LED does not light, no signal is present on the TPS input port. Check the source device and the CATx cable.	 2.3.3
	TPS mode problem	Check the actual TPS mode and the selected modes of the extenders.	 5.5.1  7.5.25
	The output is muted	Check the mute state of output port.	 5.5.3  6.4.7  7.5.2
	Display is not able to receive the video format	Check the emulated EDID; select another (e.g. emulate the EDID of the display on the input port).	 5.7  7.14
	HDCP is disabled	Enable HDCP on the input and output port.	 5.5.1  5.5.2  5.5.3  7.5.18  7.5.19
	Not the desired picture displayed on the video output	Video output is set to test pattern (no sync screen) statically	Check Test Pattern settings in the HDMI output properties.
Video output is set to test pattern (no sync screen) as there is no picture on video source		Check video settings of the source.	

Symptom	Root cause	Action	Refer to
Audio signal			
No audio is present on output	Source audio volume is low or muted	Check the audio settings of the source.	
	Output port is muted	Check the output port properties.	 5.5.5  5.5.6  6.4.7  7.6.2
	Analog audio volume is set low	Check the Analog audio output port settings (volume).	 5.5.6  7.7.1
HDMI output signal contains no audio	HDMI mode is set to DVI	Check the properties of the output port and set to HDMI or Auto.	 5.5.3  7.5.23
	DVI EDID is emulated	Check the EDID and select and HDMI EDID to emulate.	 5.7  7.14
RS-232 signal			
Connected serial device does not respond	Cable connection problem	Check the connectors to fit well; check the wiring of the plugs.	 3.2.7
	RS-232 settings are different	Check the port settings of the transmitter and/or the receiver and the connected serial device(s). Pay attention to Link and/or Local ports.	 5.8.1  6.6  7.9
	RS-232 mode is not right	Check the RS-232 mode settings (pass-through, control or command injection)	 5.8.1  6.6.1  7.9.2
Network			
No LAN connection can be established	Incorrect IP address is set (fix IP)	Use dynamic IP address by enabling DHCP option.	 2.4.2  5.10.2  6.5.3  7.8.2
			Restore the factory default settings (with fix IP).
	IP address conflict	Check the IP address of the other devices.	

Symptom	Root cause	Action	Refer to
Miscellaneous			
Front panel buttons are out of operation	Front panel buttons are locked	Unlock the buttons	 5.10.3  7.4.7
Error messages received always	Different protocol is set	Check the port protocol settings (LW2 / LW3) and use the proper protocol commands.	 5.8.1  6.6.4  6.6.5  7.9.1
I cannot find my device in the server room	All AV boxes and gadgets look the same	Use the "Identify Me" feature	 5.3  5.10.1  7.4.5

8.2. How to Speed Up the Troubleshooting Process

Lightware's technical support team is always working hard to provide the fastest support possible. Our team's response time is one of the best in the industry and in the toughest of cases we can directly consult with the hardware or software engineer who designed the product to get the information from the most reliable source.

However, the troubleshooting process can be even faster... with your help.

There are certain pieces of information that push us in the right direction to finding the root cause of the problem. If we receive most of this information in the first e-mail or it is gathered at the time when you call us, then there is a pretty high chance that we will be able to respond with the final solution right away.

This information is the following:

- Schematic (a pdf version is preferred, but a hand drawing is sufficient).
- Serial number(s) of the device(s) (it is either printed somewhere on the box or you can query it in the Device Controller software or on the built-in website).
- Firmware versions of the devices (please note that there may be multiple CPUs or controllers in the device and we need to know all of their firmware versions, a screenshot is the best option).
- Cable lengths and types (in our experience, it's usually the cable).
- Patch panels, gender changers or anything else in the signal path that can affect the transmission.
- Signal type (resolution, refresh rate, color space, deep color).
- Emulated EDID(s) (please save them as file and send them to us).
- Actions to take in order to re-create the problem (if we cannot reproduce the problem, it is hard for us to find the cause).
- Photo or video about the problem ('image noise' can mean many different things, it's better if we see it too).
- Error logs from the Device Controller software.
- In the case of Event Manager issue the event file and/or backup file from the Device Controller software.

The more of the above information you can give us the better. Please send these information to the Lightware Support Team (support@lightware.com) to speed up the troubleshooting process.

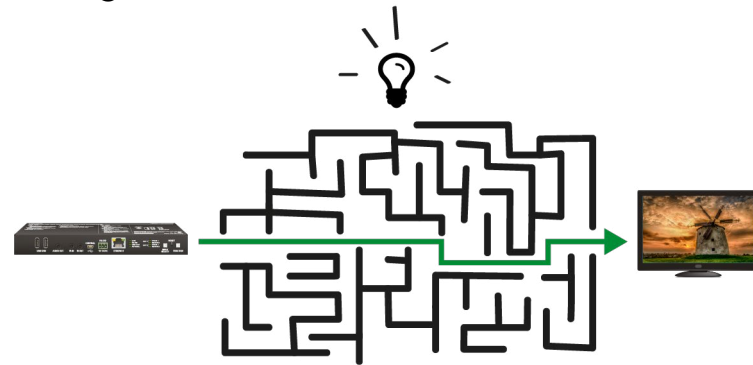

9

Technologies

The following sections contain descriptions and useful technical information how the devices work in the background. The content is based on experiences and cases we met in the practice. These sections help to understand features and technical standards like the followings:

- ▶ EDID MANAGEMENT
- ▶ HDCP MANAGEMENT
- ▶ PIXEL ACCURATE RECLOCKING

9.1. EDID Management

9.1.1. Understanding the EDID

The Extended Display Identification Data (EDID) is the passport of display devices (monitors, TV sets, projectors). It contains information about the capabilities of the display, such as supported resolutions, refresh rates (these are called Detailed Timings), the type and manufacturer of the display device, etc.

After connecting a source to a display (DVI, HDMI, DP), the source reads out the EDID to determine the resolution and refresh rate of the image to be transmitted.

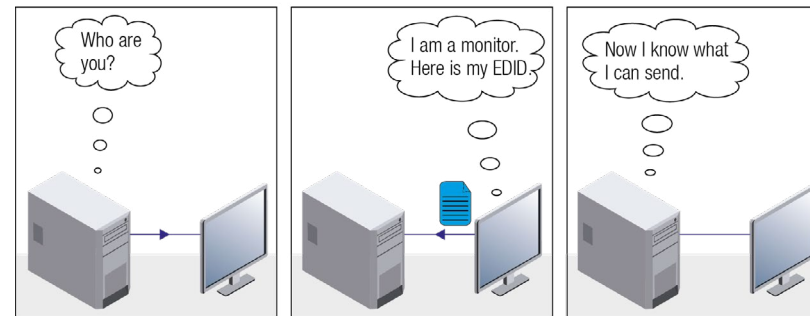

EDID Communication

Most DVI computer displays have 128-byte long EDID structure. However, Digital Televisions and HDMI capable displays may have another 128 bytes, which is called E-EDID and defined by CEA (Consumer Electronics Association). This extension contains information about additional Detailed Timings, audio capabilities, speaker allocation and HDMI capabilities. It is important to know that all HDMI capable devices must have CEA extension, but not all devices with CEA extension are HDMI capable.

Common Problems Related to EDID

Problem: “My system consists of the following: a computer, a Lightware device, a WUXGA (1920x1200) LCD monitor, and an SXGA (1280x1024) projector. I would like to see the same image on the monitor and the projector. What EDID should I choose on the Lightware device?”

Solution: If you want to see the image on both displays, you need to select the resolution of the smaller display (in this case SXGA), otherwise the smaller display may not show the higher resolution image.

Problem: “I have changed to a different EDID on an input port of the Lightware device to have a different resolution but nothing happens.”

Solution: Some graphics cards and video sources read out the EDID only after power-up and later they do not sense that EDID has been changed. You need to restart your source to make it read out the EDID again.

9.1.2. Advanced EDID Management

Each DVI sink (e.g. monitors, projectors, plasma displays, etc...) must support the EDID data structure. Source BIOS and operating systems are likely to query the sink using DDC2B protocol to determine what pixel formats and interface are supported. DVI standard uses EDID data structure to identify the monitor type and capabilities. Most DVI sources (VGA cards, set top boxes, etc.) will output DVI signal after accepting the connected sink's EDID information. In the case of EDID readout failure or missing EDID, the source will not output DVI video signal.

Lightware devices provide the Advanced EDID Management function that helps system integration. The built-in EDID Router can store and emulate factory pre-programmed- and User programmable EDIDs. The EDID of the attached monitors or projectors for each output are stored in a non-volatile memory. This way the EDID of a monitor is available when the monitor is unplugged or switched off.

Any EDID can be emulated on any input. An emulated EDID can be copied from the EDID router's memory (static EDID emulation), or from the last attached monitor's memory (dynamic EDID emulation). For example, the Lightware device can be set up to emulate a sink device, which is connected to one of the outputs. In this case, the EDID automatically changes, if the monitor is replaced with another display device (as long as it has a valid EDID).

EDID is independently programmable for all inputs without affecting each other. All inputs have their own EDID circuit.

INFO: The user is not required to disconnect the video cable to change an EDID as opposed to other manufacturer's products. EDID can be changed even if a source is connected to the input and powered ON.

INFO: When EDID has been changed, the router toggles the HOTPLUG signal for 2 seconds. Some sources do not sense this signal. In such cases, the source device must be restarted or powered OFF and ON again.

9.2. HDCP Management

Lightware Visual Engineering is a legal HDCP adopter. Several functions have been developed which helps to solve HDCP related problems. Complex AV systems often have both HDCP and non-HDCP components. The receiver allows transmitting HDCP encrypted and unencrypted signals. The devices will be still HDCP compliant as they will never output an encrypted signal to a non-HDCP compliant display device. If an encrypted signal is switched to a non-compliant output, a red screen alert or muted screen will appear.

9.2.1. Protected and Unprotected Content

Many video sources send HDCP protected signal if they detect that the sink is HDCP capable – even if the content is not copyrighted. This can cause trouble if an HDCP capable device is connected between the source and the display. In this case, the content cannot be viewed on non-HDCP capable displays and interfaces like event controllers. Rental and staging technicians often complain about certain laptops, which are always sending HDCP encrypted signals if the receiver device (display, matrix router, etc.) reports HDCP compliancy. However, HDCP encryption is not required all the time e.g. computer desktop image, certain laptops still do that.

To avoid unnecessary HDCP encryption, Lightware introduced the HDCP enabling/disabling function: the HDCP capability can be disabled in the Lightware device. If HDCP is disabled, the connected source will detect that the sink is not HDCP capable, and turn off authentication.

9.2.2. Disable Unnecessary Encryption

HDCP Compliant Sink

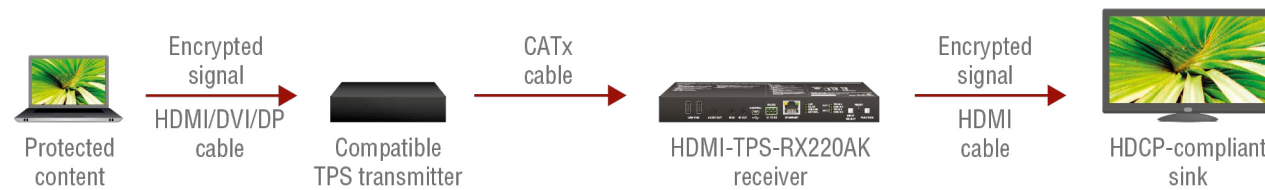

All the devices are HDCP-compliant, no manual setting is required, both protected and unprotected contents are transmitted and displayed on the sink.

Not HDCP-compliant Sink 1.

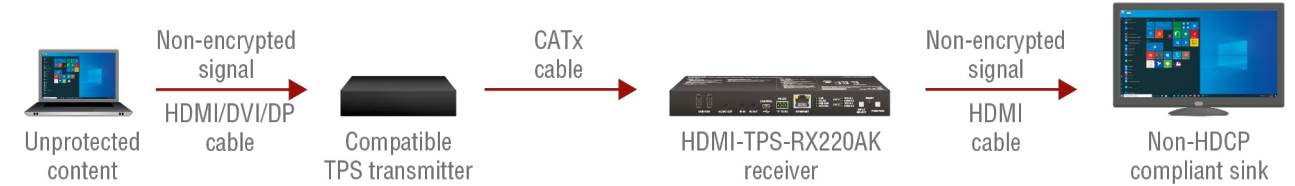

Non-HDCP compliant sink is connected to the receiver. Some sources (e.g. computers) always send HDCP encrypted signals if the receiver device reports HDCP compliancy, however, HDCP encryption is not required all the time (e.g. computer desktop image). If HDCP is enabled in the receiver, the image will not be displayed on the sink.

Setting the HDCP parameter to Auto on the output port and disable HDCP on the input port, the transmitted signal will not be encrypted if the content is not protected. Thus, non-HDCP compliant sinks will display non-encrypted signal.

Not HDCP-compliant Sink 2.

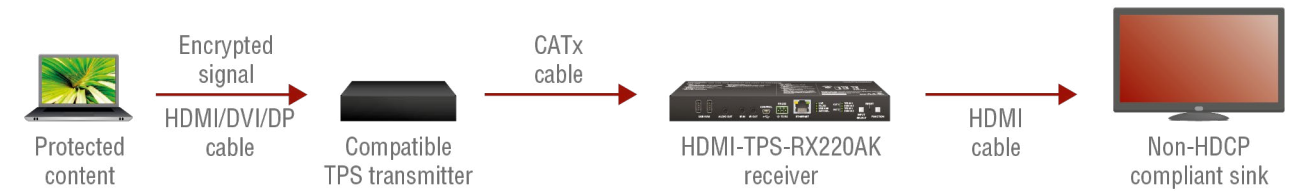

The layout is the same as in the previous case: non-HDCP compliant display device is connected to the receiver but the source would send protected content with encryption. If HDCP is enabled on the input port of the receiver, the source will send encrypted signal. The sink is not HDCP compliant, thus, it will not display the video signal (but blank/red/muted/etc. screen). If HDCP is disabled on the input port of the receiver, the source will not send the signal. The solution is to replace the display device to an HDCP-capable one.

9.3. Pixel Accurate Reclocking

Signal reclocking is an essential important procedure in digital signal transmission. After passing the reclocking circuit, the signal becomes stable, jitter-free, and can be transmitted over more equipment like processors, or event controllers. Without reclocking, sparkles, noise, and jaggies appear on the image.

Lightware's sophisticated Pixel Accurate Reclocking technology fixes more problems than general TMDS reclocking. It removes not only intra-pair skew but inter-pair skew as well. The Pixel Accurate Reclocking circuit eliminates the following errors:

Intra-pair skew

Skew between the + and - wires within a differential wire pair (e.g. Data2- and Data2+). It's caused by different wire lengths or slightly different wire construction (impedance mismatch) in DVI cable. It results in jitter.

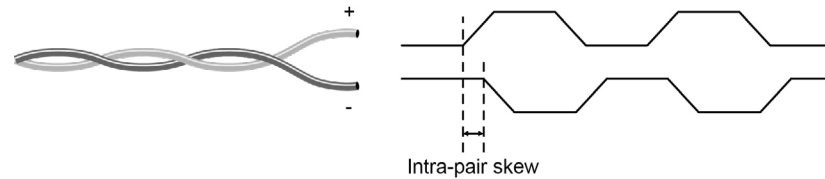

Inter-pair skew

Skew between two differential wire pairs in a cable. It is caused by different wire pair lengths or different number of twists in the DVI cable. Too much inter-pair skew results color shift in the picture or sync loss.

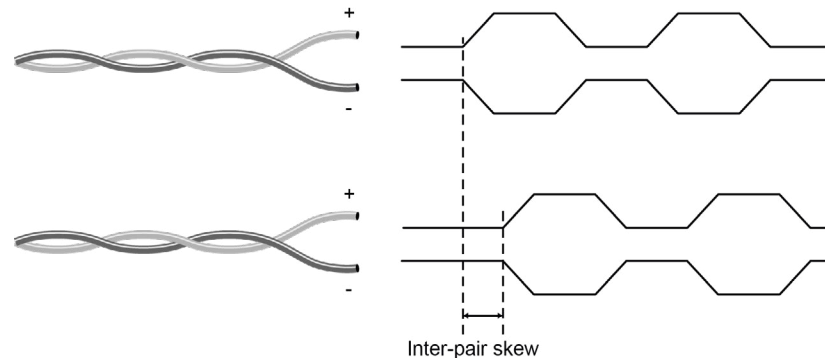

Jitter

Signal instability in the time domain. The time difference between two signal transitions should be a fixed value, but noise and other effects cause variations.

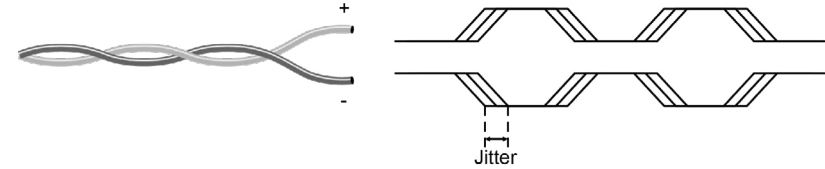

Noise

Electromagnetic interference between other electronic devices such as mobile phones, motors, etc. and the DVI cable are coupled onto the signal. Too much noise results in increased jitter.

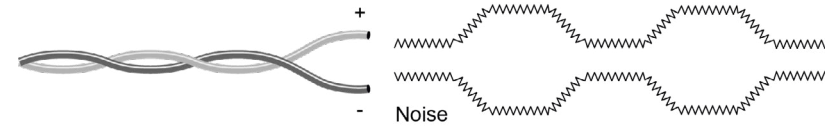

10

Appendix

Tables, drawings, guides, and technical details as follows:

- ▶ SPECIFICATION
- ▶ INPUT/OUTPUT PORT NUMBERING
- ▶ CONTENT OF BACKUP FILE
- ▶ FACTORY DEFAULT SETTINGS
- ▶ MAXIMUM EXTENSION DISTANCES
- ▶ CABLE WIRING GUIDE
- ▶ FACTORY EDID LIST
- ▶ MECHANICAL DRAWINGS
- ▶ HASHTAG KEYWORD LIST
- ▶ FURTHER INFORMATION

10.1. Specification

General

Compliance	CE
EMC compliance (emission).....	IEC/EN 55032:2015
EMC compliance (immunity).....	IEC/EN 55024:2011
Warranty	3 years
Cooling.....	Passive
Operating temperature	0 to +50°C (+32 to +122°F)
Operating humidity	10% to 90%, non-condensing

Power

Power supply.....	External power adaptor or PoE remote powering
Power adaptor.....	In 100-240 V AC 50/60 Hz, Out 12V DC, 2 A
Power connector.....	Locking DC connector (2.1 mm pin)
Power over TPS.....	DC 48V, 1A (IEEE 802.3af)
Power consumption.....	10 W (typ)

Enclosure

Rack mountable	Yes
Material.....	1 mm steel
Dimensions in mm.....	221W x 100.4D x 26H
Dimensions in inch	8.7 W x 3.95 D x 1.02 H
Weight.....	607 g

Audio/Video Ports

TPS Input Port

TPS port connector type.....	RJ45 connector
Number of port.....	1
Power over Ethernet (PoE)	Yes (IEEE 802.3af)
Compliance	HDBaseT™
Transferred signals (TPS)	Video, Audio, RS-232, Infrared, Ethernet
Max. video resolutions	1920x1080@120 Hz, 24 bit
.....	1600x1200@60 Hz, 36 bit
.....	3840x2160@30 Hz, 24 bit

Audio formats	8 channel PCM
.....	Dolby TrueHD
.....	DTS-HD Master Audio 7.1
Reclocking	Pixel Accurate Reclocking
HDCP compliant.....	Yes, HDCP 1.4

HDMI Input Port

HDMI port connector type.....	19-pole HDMI Type A receptacle
Number of ports.....	1
Standard	DVI 1.0, HDMI 1.4
Max. video resolutions	1920x1080@120 Hz, 24 bit
.....	1600x1200@60 Hz, 36 bit
.....	3840x2160@30 Hz, 24 bit
Audio formats	8 channel PCM
.....	Dolby TrueHD
.....	DTS-HD Master Audio 7.1
Reclocking	Pixel Accurate Reclocking
HDCP compliant.....	Yes, HDCP 1.4

HDMI Output Ports

Number of ports.....	2
HDMI port connector type.....	19-pole HDMI Type A receptacle
Standard	DVI 1.0, HDMI 1.4
Max. video resolutions	1920x1080@120 Hz, 24 bit
.....	1600x1200@60 Hz, 36 bit
.....	3840x2160@30 Hz, 24 bit
Audio formats	8 channel PCM
.....	Dolby TrueHD
.....	DTS-HD Master Audio 7.1
Reclocking	Pixel Accurate Reclocking
HDCP compliant.....	Yes, HDCP 1.4

Analog Audio Output Port

Audio port connector.....	3.5mm TRS (approx. 1/8" jack)
Number of ports.....	1
Signal transmission	Balanced and unbalanced audio
Volume.....	-95.62 – 0 dB

USB KVM Ports

Port type	USB-A female connector
Standard	USB 2.0
Number of ports.....	2

Control Ports**RS-232 Control**

Serial port connector	3-pole Phoenix connector
Number of ports.....	1
Available Baud rates	between 4800 and 115200
Available Data bits	8 or 9
Available Parity.....	None / Odd / Even
Available Stop bits	1 / 1.5 / 2

USB Control

Number of ports	
USB connector	USB mini B type
USB 2.0 compliance.....	Yes
Number of ports.....	1

Infrared Control

Connector type.....	3.5mm TRS (approx. 1/8" jack)
Number of ports.....	2 (1x RX, 1x TX)

Ethernet Control

Connector type.....	Locking RJ45
Number of ports.....	1
Ethernet data rate	10/100Base-T, full duplex with autodetect
Power over Ethernet (PoE)	Not supported

10.2. Input/Output Port Numbering

The following table contains the input and output ports with their ID numbers which shall be used when LW2 / LW3 protocol command sending or in the Lightware Device Controller (LDC) software.

Audio/Video Ports

Port name	Video port number		Emulated EDID memory	Audio port number	
	LW2	LW3		LW2	LW3
TPS in 1	1	I1	E1	1	I1
HDMI in 2	2	I2	E2	2	I2
HDMI out 1	1	O1	-	1	O1
HDMI out 2	2	O2	-	2	O2
Analog audio out	-	-	-	3	O3

RS-232 Ports

Port name	Description	Port nr. (LW3)
RS-232	Local serial port	P1
TPS in 1	TPS RS-232 link port	P2

Infrared Ports

Port name	Description	Port nr. (LW3)
IR in	Local IR input	S1
IR out	Local IR output	D1
TPS in 1	TPS IR link input	S2
TPS in 1	TPS IR link output	D2

10.3. Content of Backup File

The backup file contains numerous settings and parameters saved from the device. When the file is uploaded to a device, the followings will be overwritten:

TPS input port
Video port name, Audio port name, HDCP setting
Ethernet port name, Ethernet port status (enable / disable)
Remote port name, Remote port status (enable / disable)
HDMI input port
Video port name, Audio port name, HDCP setting
HDMI output port
Port name, HDCP mode, HDMI mode, Power +5V mode
Test pattern mode, clock source, and type
Audio port name, Audio output enabled, S/PDIF mode
Analog audio output port
Port name, Volume, Balance
Port parameters
Mute video ports
Mute audio ports, Lock audio ports
Local and TPS serial port
RS-232 mode, Control protocol, Baud rate, Data bits, Stop bits, Parity
Port name and CI (Command Injection) port number
Local and TPS IR port
Port status (enable / disable), Code length, Repetition code, Enable modulation
Input port name, Output port name
CI status (enable / disable), CI port number
USB port
Port name, Port status (enable / disable)
Network settings
DHCP status (enable / disable)
Static IP address, Network mask, Gateway address
Further settings
User EDID data (U1-U15)
Event manager: settings of all Events (E1-E100)

10.4. Factory Default Settings

Parameter	Setting/Value
Video port settings	
TPS mode	Auto
Signal type (HDMI/DVI)	Auto
HDCP	Enabled
Emulated EDID on input ports	F47 (1920x1080p60Hz, 2chLPCM)
Test pattern mode	Disabled
Test pattern clock source	480p
Test pattern	Bar
Output HDMI mode	Auto
Output HDCP mode	Auto
Power 5V mode	Always on
Analog audio port settings	
Volume	0.00 dB (100%)
Balance	0 (center)
Network settings	
IP address	192.168.0.100
Subnet mask	255.255.255.0
Static gateway	192.168.0.1
DHCP	Disabled
Port numbers (LW2 / LW3 / HTTP)	10001 / 6107 / 80
TPS Ethernet status	Enabled
RS-232 settings	
Control protocol	LW2
Baud rate	57600
Databits	8
Parity	No
Stopbits	1
Operation mode (Link and Local)	Pass-through
Command injection port nr. (Local / TPS)	8001 / 8002
IR port settings	
Command injection status	Enabled
Comm. inj. input port nr. (Local / TPS)	9001 / 9002
Comm. inj. output port nr. (Local / TPS)	9003 / 9004

10.5. Maximum Extension Distances

Resolution	Pixel clock rate	Cable lengths (Auto / Longreach TPS mode)		
		CAT5e AWG24	CAT7 AWG26**	CAT7 AWG23
1024x768@60Hz	65 MHz	100 m / 130 m*	90 m / 120 m*	120 m / 170 m*
1280x720p@60Hz	73.8 MHz	100 m / 130 m*	90 m / 120 m*	120 m / 170 m*
1920x1080p@60Hz / 24bpp	148.5 MHz	100 m / 130 m*	90 m / 120 m*	120 m / 170 m*
1920x1200@60Hz	152.9 MHz	100 m / NA	90 m / NA	120 m / NA
1600x1200@60Hz	162 MHz	100 m / NA	90 m / NA	120 m / NA
1920x1080@60Hz / 36bpp	223.6 MHz	70 m / NA	70 m / NA	100 m / NA
3840x2160@30Hz UHD	297 MHz	70 m / NA	70 m / NA	100 m / NA
4096x2160@30Hz 4K	297 MHz	70 m / NA	70 m / NA	100 m / NA

* With Long reach operation mode which supports pixel clock frequencies up to 148.5 MHz.

** When remote powering is used with AWG26 cables, distances are 20% shorter.

10.6. Cable Wiring Guide

Cable Wiring Guide for Serial Data Transmission

The receiver is built with 3-pole Phoenix connector. See below the two examples of the most common assembling cases.

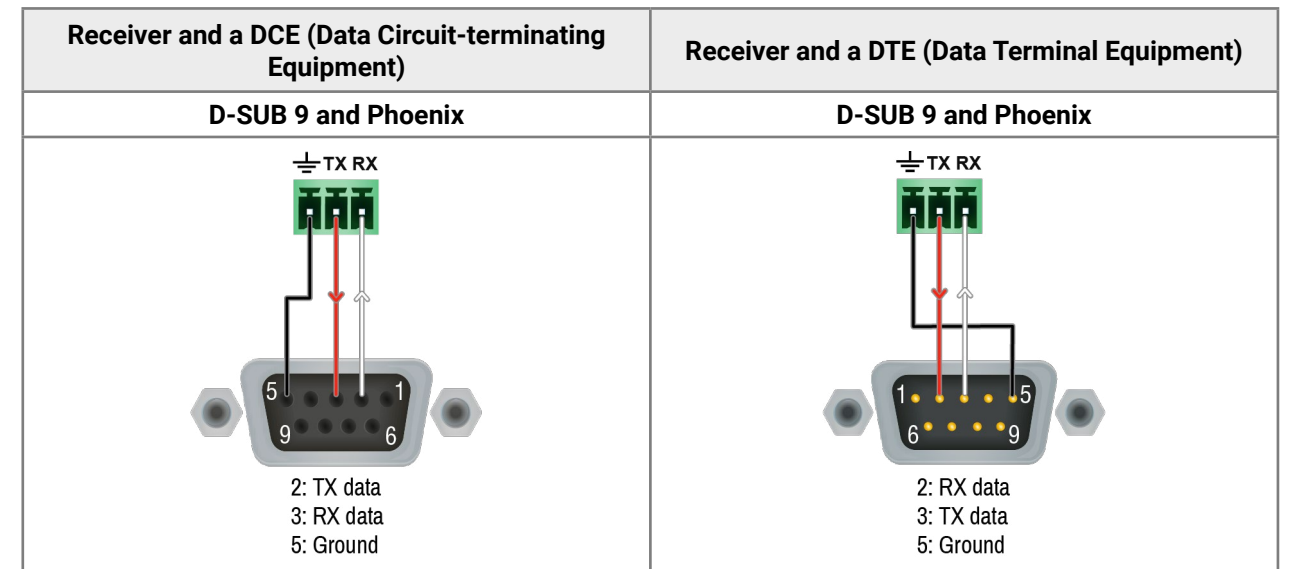

10.7. Factory EDID List

Mem.	Resolution	Type
F1	640 x 480p @ 60.00 Hz	D
F2	848 x 480p @ 60.00 Hz	D
F3	800 x 600p @ 60.32 Hz	D
F4	1024 x 768p @ 60.00 Hz	D
F5	1280 x 768p @ 50.00 Hz	D
F6	1280 x 768p @ 59.94 Hz	D
F7	1280 x 768p @ 75.00 Hz	D
F8	1360 x 768p @ 60.02 Hz	D
F9	1280 x 1024p @ 50.00 Hz	D
F10	1280 x 1024p @ 60.02 Hz	D
F11	1280 x 1024p @ 75.02 Hz	D
F12	1400 x 1050p @ 50.00 Hz	D
F13	1400 x 1050p @ 60.00 Hz	D
F14	1400 x 1050p @ 75.00 Hz	D
F15	1680 x 1050p @ 60.00 Hz	D
F16	1920 x 1080p @ 50.00 Hz	D
F17	1920 x 1080p @ 60.00 Hz	D
F18	2048 x 1080p @ 50.00 Hz	D
F19	2048 x 1080p @ 60.00 Hz	D
F20	1600 x 1200p @ 50.00 Hz	D
F21	1600 x 1200p @ 60.00 Hz	D
F22	1920 x 1200p @ 50.00 Hz	D
F23	1920 x 1200p @ 59.56 Hz	D
F24	2048 x 1200p @ 59.96 Hz	D
F29	1920 x 1080p @ 60.00 Hz	Universal
F30	1440 x 480i @ 60.05 Hz	H
F31	1440 x 576i @ 50.08 Hz	H
F32	640 x 480p @ 59.95 Hz	H
F33	720 x 480p @ 59.94 Hz	H
F34	720 x 576p @ 50.00 Hz	H

Mem.	Resolution	Type
F35	1280 x 720p @ 50.00 Hz	H
F36	1280 x 720p @ 60.00 Hz	H
F37	1920 x 1080i @ 50.04 Hz	H
F38	1920 x 1080i @ 50.00 Hz	H
F39	1920 x 1080i @ 60.05 Hz	H
F40	1920 x 1080i @ 60.05 Hz	H
F41	1920 x 1080p @ 24.00 Hz	H
F42	1920 x 1080p @ 25.00 Hz	H
F43	1920 x 1080p @ 30.00 Hz	H
F44	1920 x 1080p @ 50.00 Hz	H
F45	1920 x 1080p @ 59.94 Hz	H
F46	1920 x 1080p @ 60.00 Hz	H
F47	1920 x 1080p @ 60.00 Hz	Universal
F48	1920 x 1080p @ 60.00 Hz	Universal
F49	1920 x 1080p @ 60.00 Hz	Universal
F90	1920 x 2160p @ 59.99 Hz	D
F91	1024 x 2400p @ 60.01 Hz	D
F94	2048 x 1536p @ 60.00 Hz	D
F96	2560 x 1600p @ 59.86 Hz	D
F97	3840 x 2400p @ 24.00 Hz	D
F98	1280 x 720p @ 60.00 Hz	H
F99	1920 x 1080p @ 60.00 Hz	H
F100	1024 x 768p @ 60.00 Hz	H
F101	1280 x 1024p @ 50.00 Hz	H
F102	1280 x 1024p @ 60.02 Hz	H
F103	1280 x 1024p @ 75.02 Hz	H
F104	1600 x 1200p @ 50.00 Hz	H
F105	1600 x 1200p @ 60.00 Hz	H
F106	1920 x 1200p @ 59.56 Hz	H
F107	2560 x 1440p @ 59.95 Hz	H

Mem.	Resolution	Type
F108	2560 x 1600p @ 59.86 Hz	H
F109	3840 x 2400p @ 24.00 Hz	H
F110	3840 x 2160p @ 24.00 Hz	H
F111	3840 x 2160p @ 25.00 Hz	H
F112	3840 x 2160p @ 30.00 Hz	H
F118	3840 x 2160p @ 30.00 Hz	Universal
F119	3840 x 2160p @ 30.00 Hz	Universal
F120	3840 x 2160p @ 60.00 Hz	H

Legend

D: DVI EDID

H: HDMI EDID

U: Universal EDID, supporting many standard resolutions:

- **F29:** Universal EDID for DVI signals (no audio support).
- **F47:** HDMI EDID supporting PCM audio.
- **F48:** HDMI EDID supporting all type of audio.
- **F49:** HDMI EDID supporting all type of audio and deep color.
- **F89:** Universal EDID for analog signals (no audio support).
- **F118:** HDMI EDID supporting PCM audio and 4K@30 Hz signals.
- **F119:** HDMI EDID supporting all type of audio and 4K@30 Hz signals.

Please note that minor changes in the factory EDID list may be applied in farther firmware versions.

10.8. Mechanical Drawings

The following drawings present the physical dimensions of the receiver. Dimensions are in mm.

Front View

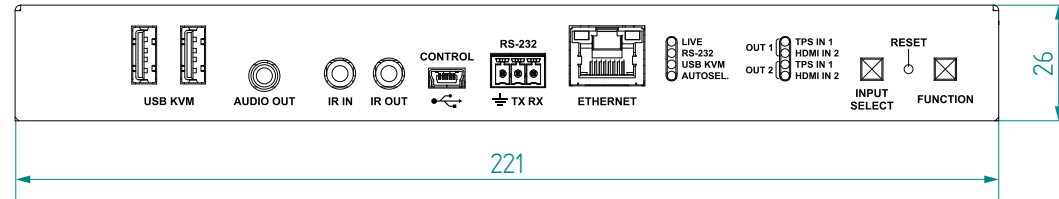

Rear View



Top View

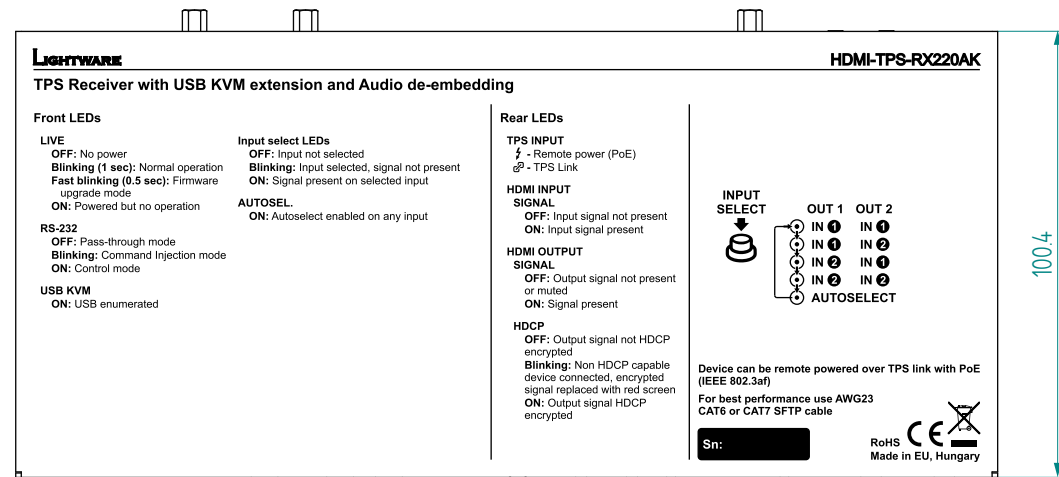

Side View

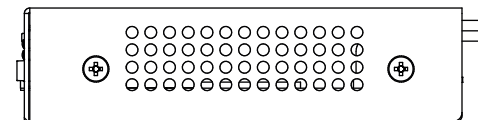

Bottom View

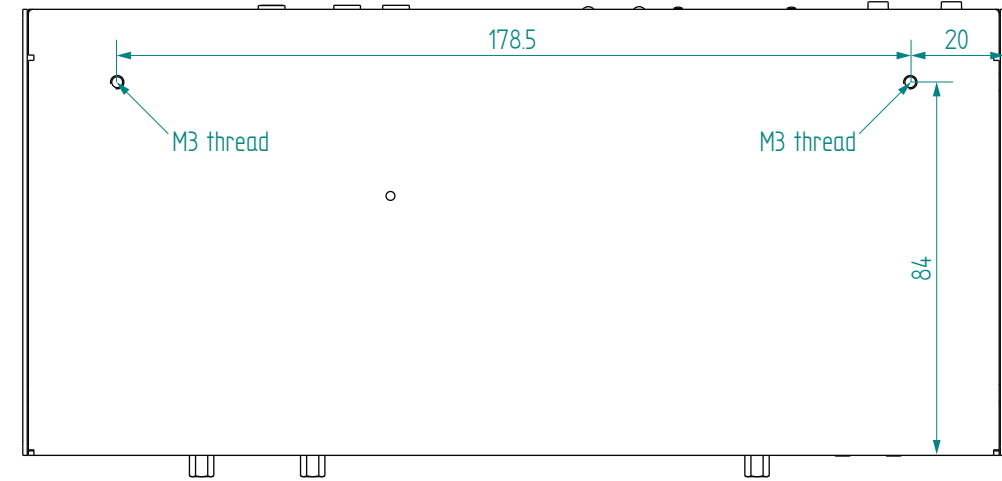

10.9. Hashtag Keyword List

This user's manual contains keywords with hashtag (#) to help you to find the relevant information as quick as possible.

The format of the keywords is the following:

#<keyword>

The usage of the keywords: use the **Search** function (Ctrl+F / Cmd+F) of your PDF reader application, type the # (hashtag) character and the wished keyword.

The **#new** special keyword indicates a new feature/function that has just appeared in the latest firmware or software version.

Example

#dhcp

This keyword is placed at the DHCP (dynamic IP address) setting in the front panel operation, the Lightware Device Controller (LDC) and the LW3 programmer's reference section.

The following list contains all hashtag keywords placed in the document with a short description belonging to them. The list is in **alphabetical order** by the hashtag keywords.

Hashtag Keyword ↓	Description
<i>#advancedview</i>	Advanced view / Terminal window
<i>#analogaudio</i>	Analog audio related settings
<i>#autoselect</i>	Autoselect feature settings
<i>#backup</i>	Configuration cloning (backup)
<i>#balance</i>	Balance (for analog audio) setting
<i>#bootload</i>	Bootload mode setting
<i>#builtinweb</i>	Built-in miniweb
<i>#buttonlock</i>	Front panel button lock setting
<i>#cablediagnostics</i>	Cable diagnostics tool in LDC
<i>#cec</i>	CEC related settings
<i>#commandinjection</i>	RS-232 command injection settings
<i>#configurationcloning</i>	Configuration cloning (backup)
<i>#crosspoint</i>	Crosspoint switch setting
<i>#darkmode</i>	Dark mode setting
<i>#devicelabel</i>	Device label
<i>#dhcp</i>	Dynamic IP address (DHCP) setting
<i>#diagnostic</i>	Failure diagnostic related tool/information
<i>#edid</i>	EDID related settings
<i>#eventmanager</i>	Event manager
<i>#factory</i>	Factory default settings
<i>#firmwareversion</i>	Firmware version query
<i>#framedetector</i>	Frame detector in LDC
<i>#function</i>	Function button
<i>#hdc</i>	HDCP-encryption related setting
<i>#identifyme</i>	Identify me (identify the device) feature
<i>#infra</i>	Infrared port related settings
<i>#infrared</i>	Infrared port related settings
<i>#ipaddress</i>	IP address related settings
<i>#label</i>	Device label
<i>#lock</i>	Port lock setting
<i>#lockbutton</i>	Front panel button lock setting
<i>#log</i>	System log
<i>#message</i>	Message sending via communication ports
<i>#miniweb</i>	Built-in miniweb

Hashtag Keyword ↓	Description
<i>#mute</i>	Port mute setting
<i>#network</i>	Network (IP address) related settings
<i>#nosyncscreen</i>	Test pattern (no sync screen) settings
<i>#portstatus</i>	Source/destination port status query
<i>#producttype</i>	Product type query
<i>#protocol</i>	RS-232 protocol setting
<i>#reboot</i>	Restarting the device
<i>#recognizer</i>	RS-232 recognizer related settings
<i>#restart</i>	Restarting the device
<i>#rs232</i>	RS-232 related settings
<i>#rs-232</i>	RS-232 related settings
<i>#rs232recognizer</i>	RS-232 recognizer related settings
<i>#rs-232recognizer</i>	RS-232 recognizer related settings
<i>#serial</i>	RS-232 related settings
<i>#serialnumber</i>	Serial number query
<i>#signaltype</i>	HDMI/DVI signal type setting
<i>#status</i>	Status query
<i>#switch</i>	Crosspoint switch setting
<i>#systemlog</i>	System log
<i>#terminal</i>	Advanced view / Terminal window
<i>#testpattern</i>	Test pattern (no sync screen) settings
<i>#tpsmode</i>	TPS (HDBaseT) mode setting
<i>#unlock</i>	Port unlock setting
<i>#unmute</i>	Port unmute setting
<i>#volume</i>	Volume (for analog audio) setting
<i>#web</i>	Built-in miniweb

10.10. Further Information

Limited Warranty Statement

1. Lightware Visual Engineering LLC (Lightware) warrants to all trade and end user customers that any Lightware product purchased will be free from manufacturing defects in both material and workmanship for three (3) years from purchase unless stated otherwise below. The warranty period will begin on the latest possible date where proof of purchase/delivery can be provided by the customer. In the event that no proof can be provided (empty 'Date of purchase' field or a copy of invoice), the warranty period will begin from the point of delivery from Lightware.

1.1. 25G and MODEX product series will be subject to a seven (7) year warranty period under the same terms as outlined in this document.

1.2. If during the first three (3) months of purchase, the customer is unhappy with any aspect of a Lightware product, Lightware will accept a return for full credit.

1.3. Any product that fails in the first six (6) months of the warranty period will automatically be eligible for replacement and advanced replacement where available. Any replacements provided will be warranted for the remainder of the original unit's warranty period.

1.4. Product failures from six (6) months to the end of the warranty period will either be repaired or replaced at the discretion of Lightware. If Lightware chooses to replace the product then the replacement will be warranted for the remainder of the original unit's warranty period.

2. The above-stated warranty and procedures will not apply to any product that has been:

2.1. Modified, repaired or altered by anyone other than a certified Lightware engineer unless expressly agreed beforehand.

2.2. Used in any application other than that for which it was intended.

2.3. Subjected to any mechanical or electrical abuse or accidental damage.

2.4. Any costs incurred for repair/replacement of goods that fall into the above categories (2.1., 2.2., 2.3.) will be borne by the customer at a pre-agreed figure.

3. All products to be returned to Lightware require a return material authorization number (RMA) prior to shipment and this number must be clearly marked on the box. If an RMA number is not obtained or is not clearly marked on the box, Lightware will refuse the shipment.

3.1. The customer will be responsible for in-bound and Lightware will be responsible for out-bound shipping costs.

3.2. Newly repaired or replaced products will be warranted to the end of the originally purchased products warranty period.

Document Revision History

Rev.	Release date	Changes	Editor
1.0	27-04-2020	Initial version	Tamas Forgacs

Contact Us

sales@lightware.com

+36 1 255 3800

support@lightware.com

+36 1 255 3810

Lightware Visual Engineering LLC.

Peterdy 15, Budapest H-1071, Hungary

www.lightware.com

©2020 Lightware Visual Engineering. All rights reserved. All trademarks mentioned are the property of their respective owners. Specifications subject to change without notice.