



WyreStorm 4x4 Quick-Install Matrix/receiver pack

(Version 2.0)

4 Input / 4 Output single-cable HD Matrix with IR Source control

Part Number MX-0404-QI

4 x Single Cat5e/6/7 40m (131ft) HD Receiver supporting
HDMI and IR Source control

Part Number RX-1UTP-IR-40

Instruction Manual



Thank you for choosing this WyreStorm product.
Please read these instructions carefully before installing to avoid complications later.

Contents

- 1** Introduction
- 2** Features
 - i. MX0404-QI
 - ii. RX-1UTP-IR-40
- 3** Safety Precautions
- 4** Package Contents
- 5** Specification
 - i. MX0404-QI
 - ii. RX-1UTP-IR-40
- 6** MX0404-QI Panel Description
- 7** RX-1UTP-IR-40 Panel Description
- 8** Typical Application
- 9** Connection
- 10** Basic Operation
- 11** Advanced Operation
 - i. IR Call-back and Third Party Control Systems
 - ii. RS232 Control
 - iii. COM CTL
 - iv. LAN Control – NET CTL
 - v. MX0404-QI - EDID DIP Switch settings
 - vi. RX-1UTP-IR-40 - EQ Distance adjustment settings
- 12** Troubleshooting
- 13** FAQ
- 14** Maintenance
- 15** Provided Service
- 16** Mail In Service
- 17** Warranty
 - Warranty Limits and Exclusions
- 18** Installation Notes

1. Introduction

The WyreStorm 4x4 Quick-Install pack (version 2) is a system of HD switching and extension that comprises of a 4 Input/4 Output HD Matrix together with 4 display receivers that together provide a total solution for single-cable HD Distribution and Control over distances of up to 40m (131ft) in residential or commercial settings.

Time is money.

We all know it. Especially when it comes to HD installation. Time saved in choosing the right combination of HD equipment you know will work is just as important as getting it all up and running as quickly and efficiently as possible so you can leave a satisfied customer and move onto the next job.

We call this system 'Quick Install' because that is exactly what you should expect; with great emphasis placed on reduced installation time and an ease of connection that will enable the installer to maximise their productivity on site, avoiding time-consuming compatibility and configuration issues that can unnecessarily prolong a project or in terms of installation time or call-backs.

Specifically developed and manufactured to meet the needs of the installer, the MX0404-QI is a dedicated system of HD distribution and control, combining a 4x4 Matrix and four single cable receivers – all of which of which are designed work seamlessly together for complete compatibility and full management of handshakes, screen resolutions and HD signal distribution to each display point, whether in a residential or commercial environment.

The MX0404-QI pack enables ANY four HD devices to be viewed independently and simultaneously on ANY four displays, with full 3D support over distances of up to 40m, with full control of the connected sources as well as output from the matrix from display locations via IR or RS232.

The system itself is entirely cabled on single Cat5e/6/7 UTP runs to each display point throughout the location for the quickest, most convenient and cost effective means of transmitting and controlling full, uncompressed 1080p HD video and audio we could think of to make sure your time on-site is as productive (and brief) as possible.

Time is money. With the WyreStorm Quick Install pack in your set up, you'll have a little more of both.

NOTE For longer transmission distances, LAN control and Ethernet pass-through, please see our full HDBaseT or HDBaseT Class B range of matrices, transmitters, receivers and extender sets.

For further information on this product and other WyreStorm ranges, visit our website or download our latest product guide. www.wyrestorm.com

2. Features

MX0404-QI

- Quick and easy installation – set up in seconds straight out of the box.
- Simplified ports - Input: HDMI – Output: integrated RJ45 connectors for a single Cat5e/6/7 UTP cable to each display point for ease of installation.
- Conforms to IEEE-568B standards
- Each HDMI port also supports DVI signals.
- Each Output port can be fed to multiple displays (cascaded).
- Enables up to 4 HDMI video/audio devices to be independently switched through up to 4 HDMI displays or projectors for uncompressed digital distribution.
- Each output able to show any connected source simultaneously regardless of whether the input carries HDCP encryption.
- Refined for Custom Install and Home Theatre Installations.
- Reads and copies EDID from connected devices with additional EDID configuration through customisable DIP switch settings if necessary.
- 2k resolution supported.
- Fully 3D compatible – Frame sequential 3D (Blu-ray) and interlaced stereoscopic 3D (satelClass B broadcasts etc.)
- Supports all high definition resolutions up to and including 1080p and standard video formats.
- RS232 port.
- Choose from 6 switching modes – infrared remote control, front panel buttons, local IR, IR call-back, LAN and RS232.
- Simple switching remote control included, which can also be learned into a universal remote handset to allow the control of multiple devices from one handset.
- Fully compatible for integration with market leading control systems.
- 4 x IR 3.5mm mini-jack ports for each output to link IR from control system to control display
- Additional infrared extension port for longer IR connections
- HDMI v.1.3
- Supports 24Bit Colour depth
- Signalling rate of 6.75 Gbps
- Pack comes complete with 1 x 4x4 Matrix with 19” rack brackets, 4 x 40m IR receivers with mounting brackets, IR receivers, emitters and a Matrix remote control handset.

Additional features included on the RX-1UTP-IR-40

- Transmits one-way signal together with the HDMI signal over a single Cat5e/6/7 cable.

- Receivers capable of 1080p transmissions up to 40m (131ft)
- For even greater control and fine tuning, each receiver features a fully adjustable EQ distance range for optimising the transmission signal.
- Protection against ESD (electrostatic discharge) included within the unit to further stabilise transmission.
- LED indications for clear power and video signal selection.
- 5v mains supply included
- Fully cascable to further lengthen transmission.

3. Safety Precautions



WARNING

To reduce the risk of fire, electric shock or product damage:

1. Do not expose this apparatus to rain, moisture, sprays, drips or splashes and ensure that no objects containing liquids are placed on the apparatus, including cups, glasses and vases.
2. Do not place this unit in a confined space such as enclosed shelving, cabinets or bookshelves. Ensure the unit is adequately ventilated.
3. To prevent the risk of electric shock or fire hazard due to overheating, do not cover the unit or obstruct ventilation openings with material, newspaper, cardboard or anything that may restrict airflow into the unit.
4. Do not install near external heat sources such as radiators, heat registers, boilers or any device that produces heat such as amplifiers or computers and do not place near sources of naked flame.
5. Unplug apparatus from power supply during lightning storms or when unused for long periods of time.
6. Protect the power cable from being walked on, pinched or restricted in any way, especially at plug connections.
7. Only use attachments/accessories specified by the manufacturer.
8. Units contain non-servicable parts - Refer all servicing to qualified service personnel.

4. Package Contents

- 1 x MX0404-QI main unit
- 1 x Printed instruction manual
- 1 x Flash USB stick containing PC software and digital copy of instruction manual. Digital copy also downloadable from www.wyrestorm.com
- 1 x Matrix mounting brackets (pair)
- 1 x 12VDC power supply
- 1 x IR Extension cable (IR RX)
- 4 x IR TX Emitters (small for Input source)
- 1 x MX0404-QI remote control incl. battery (size/type: CR2025 3V)
- 4 x RX-1UTP-IR-40 Display Receivers
- 4 x Receiver mounting brackets (pair)
- 4 x 5VDC power supply
- 4 x IR RX Receivers (larger for HD display)

5. Specification

MX-0404-QI

| | |
|---------------------------------------|---|
| Operating Temperature Range | -5 to +35°C (-41 to +95°C) |
| Operating Humidity Range | 5 to 90 % RH (no condensation) |
| Bandwith capacity/ Signalling Rate | 6.75Gb/s |
| Input Video Signal | 0.5-1.0 volts p-p |
| Input DDC Signal | 12 volts p-p (TTL) |
| Maximum Single Link Range | 1080p 24Bit Colour |
| Transmission distance | HDMI: 15m (49ft) – if a longer HDMI connection is necessary, we offer the WyreStorm in-line HDMI to HDMI coupler UTP: 1080p signal up to 40m / 131ft (under perfect transmission conditions. |
| Video Format Supported | VESA: 640x480, 800x600,1024x768, 1280x1024,1600x1200, 1920x1200 DTV/HDTV: 480i/576i/480p/576p/720p/1080i/1080p |
| Output Video | HDMI v1.2, HDMI v1.3 |
| Power Consumption | 22 Watts (max.) |

| | |
|-----------------------------------|--|
| BTU Rating (British Thermal Unit) | 75.02 |
| Power Supply | 100-240V AC |
| Dimensions | 440mm / 17.3" (W) 52mm / 2.05" (H) 235mm / 9.25" (D) |
| Weight | 2 Kg / 4.4lbs |
| Rack space required | 1U |

RX-1UTP-IR-40

| | |
|---------------------------------------|---|
| Operating Temperature Range | -5 to +35°C (-41 to +95°C) |
| Operating Humidity Range | 5 to 90 % RH (no condensation) |
| Bandwith capacity/ Signalling Rate | 6.75Gb/s |
| Input Video Signal | 0.5-1.0 volts p-p |
| Input DDC Signal | 5 volts p-p (TTL) |
| Maximum Single Link Range | 1080p 24Bit Colour |
| Transmission distance | HDMI: 15m (49ft) – if a longer HDMI connection is necessary, we offer the WyreStorm in-line HDMI to HDMI coupler UTP: 1080p signal up to 40m / 131ft (under perfect transmission conditions. |
| Video Format Supported | VESA: 640x480, 800x600,1024x768, 1280x1024,1600x1200, 1920x1200 DTV/HDTV: 480i/576i/480p/576p/720p/1080i/1080p |
| Output Video | HDMI v1.3 + HDCP (mirrors the input source to the output display) |
| Output Audio | Fully supports DOLBY TRUE HD AND DTS-HD (mirrors input audio source to the output) |
| IR Wavelength/Frequency Wavelength | 940 nm |
| Frequency | 38khz |
| Dimensions | 60mm / 2.4" (W) 115mm / 4.5" (H) 23mm / 0.9" (D) |
| Weight | 0.15 Kg / 0.3lbs |

6. MX0404-QI - Panel Description

FRONT

- 1** Mounting Brackets
- 2** Input select button (click to scroll numerically)
- 3** Input selection per output (click to scroll numerically)
- 4** IR Receiver port (IR RX)
- 5** AC100 – 240V power input

REAR

- 1** RS232 Port
- 2** LAN port (for control via the internet)
- 3** EDID DIP Switch
- 4** 12V DC power input
- 5** IR RX extension port
- 6** Output ports (RJ45 Cat5e/6/7)
- 7** Input ports (HDMI)
- 8** IR TX Emitter ports (corresponds to inputs)

FRONT

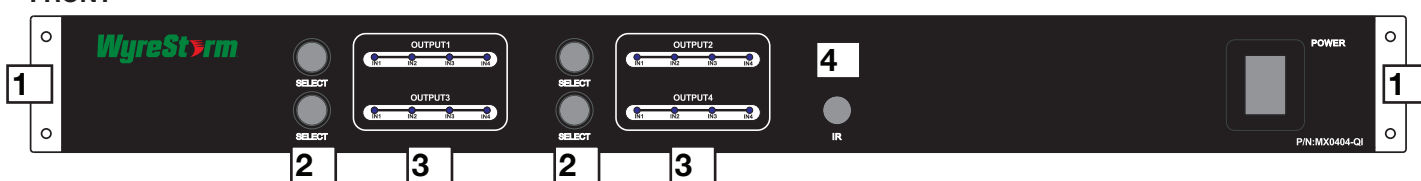

REAR

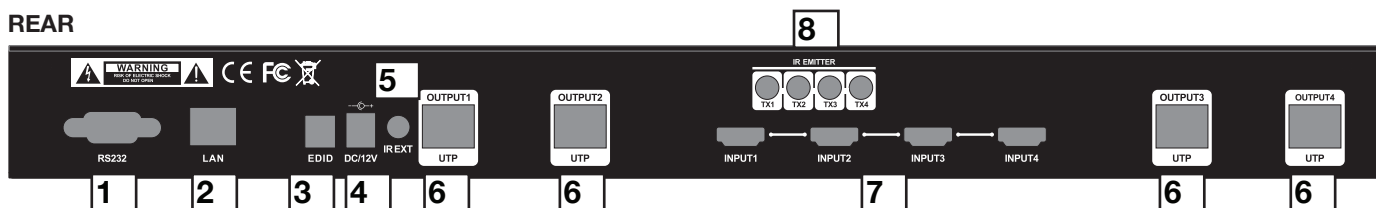

7. RX-1UTP-IR-40 - Panel Description

- 1** Power status LED (Lit when unit is powered)
- 2** Signal status LED (Lit when transmission is received)
- 3** Cat5e/6/7 connector
- 4** IR RX receiver port (placed on or near display/TV in clear line of sight to remote handset used to control)
- 5** 5V DC power input
- 6** HDMI out port (for display/projector)
- 7** EQ adjustment (fine-tuning signal to optimise strength distance)



FRONT

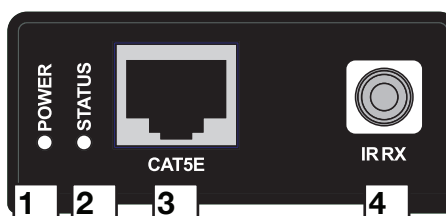

REAR

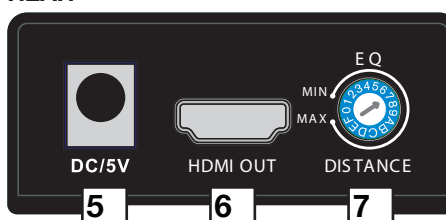

8. Typical Application

TPYICAL APPLICATION

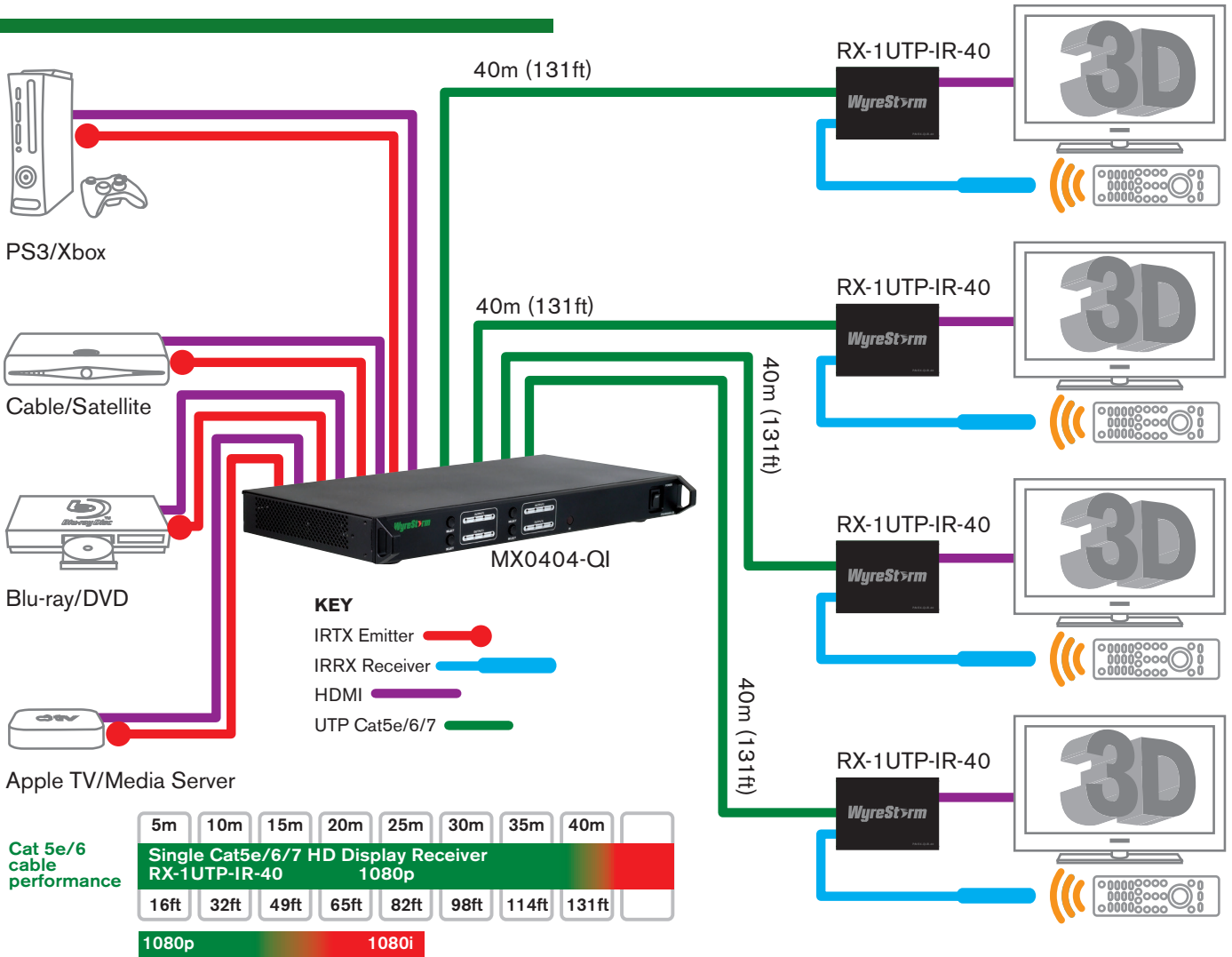

Cat 5e Wiring Guide

The quality of termination for every RJ45 is essential. Poor terminations leads to intermittent performance and longer install times.

9. Connection

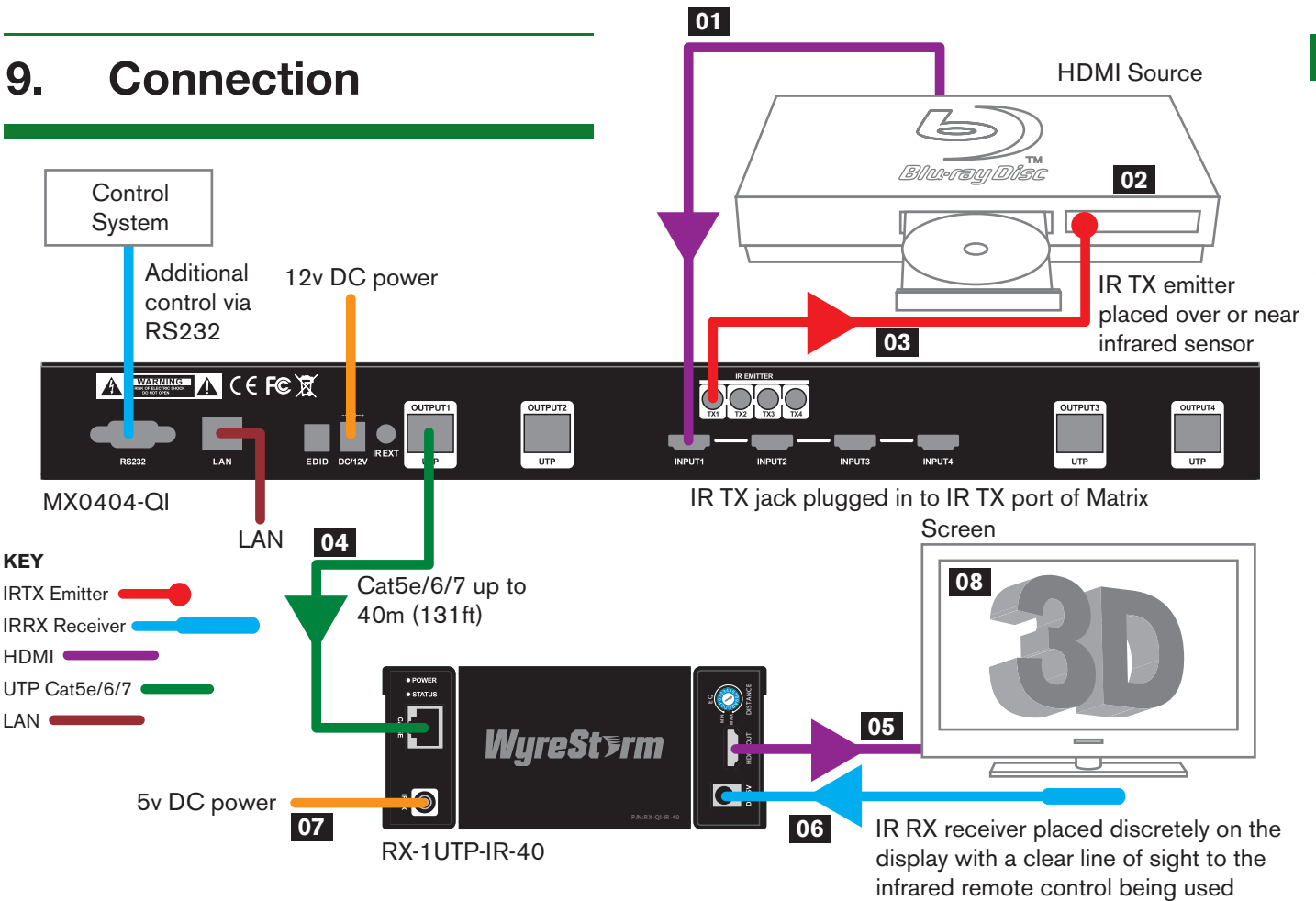

1 Connect your HDMI input sources (such as: HD-DVD, PS3/, XBOX360, satelClass B/cable, Blu-Ray etc.) to HDMI inputs 1 – 4 of the MX0404-QI MATRIX.

Attention Do Not Hotplug! - Please insert and extract cables carefully with the power SWITCHED OFF. Connecting and disconnecting while the unit is powered can result in damage to circuitry.

2 Attach the IR TX emitter sensor directly over the infraredreceiving area of the input source using the adhesive backing. You may need to adjust the position of the emitter after installation to achieve the best results. Sometimes moving the sensor to different areas of the source facia can improve IR performance.

3 Plug the 3.5mm jack of the IR TX emitter into your chosen number IR TX port on the rear panel of the MATRIX.

HINT Locate the infrared sensor on devices by shining a flashlight onto the display panel of sources and look for a small sensor.

4 Connect a good quality, well terminated Cat 5e/6/7 cable with an RJ45 connector wired to 568B standard at both ends from the UTP Out port of the MATRIX to the UTP IN of the RX-1UTP-IR-40 DISPLAY RECEIVER.

Ensure both connectors are pushed securely into each port and supported by the connector strain relief clip to prevent them from becoming loose. The quality of termination for your RJ45 is essential. Poor quality terminations lead to intermittent performance and longer install times.

Attention We strongly recommend using the supplied mounting brackets to secure the MATRIX and the accompanying DISPLAY RECEIVER baluns. Any sudden movement of these devices could lead to loss of picture and sound if connections become loose or strained, resulting in unnecessary service call backs.

5 Connect the HDMI OUT of the DISPLAY RECEIVER to the HDMI IN of the display.

6 Plug the 3.5mm jack of the IR RX receiver into the IR RX port of the display receiver balun. Place the IR RX receiver sensor discretely on the front of the display with care taken to achieve a clear line of sight with the remote control to be used. Again, you may need to adjust the position of the receiver to achieve the best signal reception.

7 Connect the DISPLAY RECEIVER balun to the 5v power adaptor (included with the receiver)

8 Switch on the power to your input sources, displays, and any display receivers used. Finally, power up the MATRIX. Your MX0404-QI should now be fully connected and ready for use.

Remember, always switch off the matrix before unplugging any inputs or outputs – follow last on, first off protocol.

9 If your IR emitters and receivers are correctly placed you should now be able control your sources from each individual display location.

If there is electrical interference or cable bends/kinks within the set up the IR is one of the first functions to fail. If you do not have IR control:

- Check your cables are straight with jacks firmly connected to ports.
- Check your IR sensors are unobstructed and able to receive infrared signals.
- Check direct sunlight on the emitters/receivers is not affecting the infrared signal.

10. Basic Operation

Front Panel Control

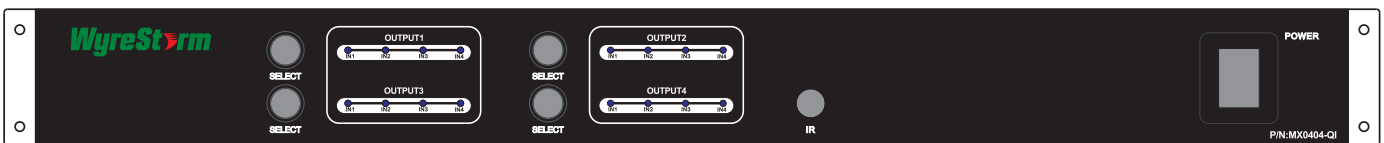

Basic switching of various source inputs to output displays can be achieved via the front panel control of the MX0404-QI.

Outputs are numbered 1 – 4 with an input select button to the left. Repeated pressing of the select button of a specific output scrolls through the HDMI input devices connected to the matrix, with the corresponding LEDs illustrating when a device has been selected for that particular output. The chosen input will automatically store for the output so, even when the matrix is powered off and on, on resumption the last selected input/output combination will remain.

Attention Users will notice a brief flicker on screen when switching between inputs/outputs – this is normal for this model and represents the matrix resetting device HDCP settings to allow communication from a different device. For constant HDCP when switching with no noticeable screen resets, see WyreStorm PRO, Pro Plus and HDBaseT matrix ranges. See www.wyrestorm.com for more information

Remote Control (Local IR)

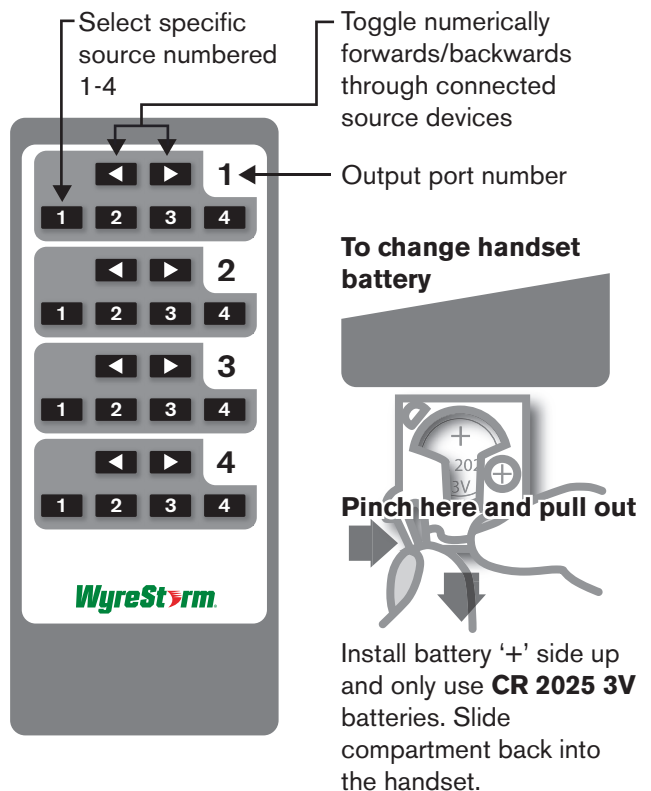

The same basic functions can also be accessed via the remote control. Operation of the handset is the same regardless of location – locally (source/IR emitter) or remotely (display/IR receiver).

Simply toggle through the input sources connected to the matrix by either pressing the left/right arrow buttons or buttons numbered 1 – 4 for each output.

IR Call-back of Matrix and Source Devices

The MX0404-QI is not only a switcher and extender of multiple HDMI signals to multiple HDMI receivers located remotely, it also passes IR control signals through the IR call-back system to the matrix and HDMI sources for full, independent control of all connected inputs from output locations using your remote handset.

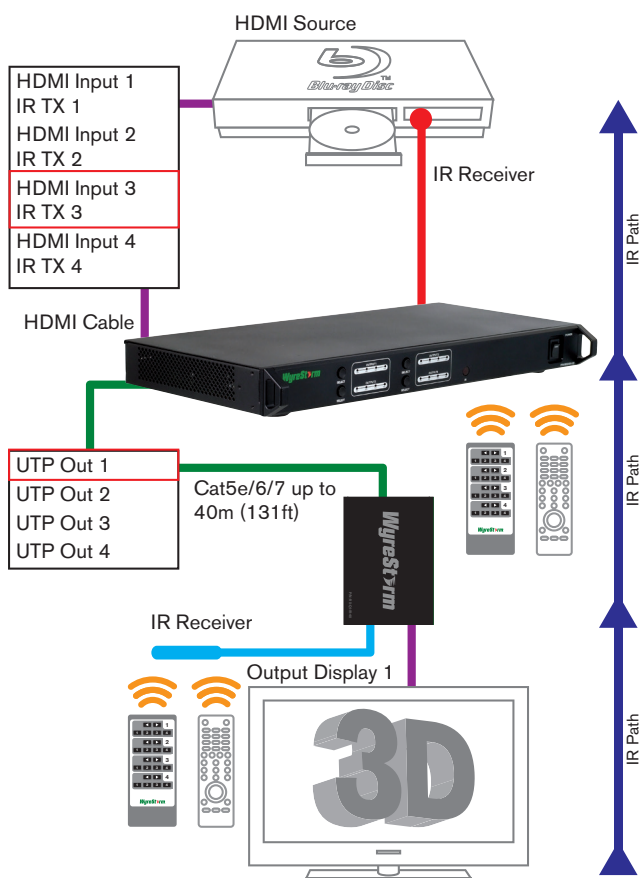

This is accomplished by placing a series of IR Emitters on source devices you wish to control and IR Receivers at all output locations you wish to control from to enable the IR control signal to be delivered via single Cat5e/6/7 cable connecting the two.

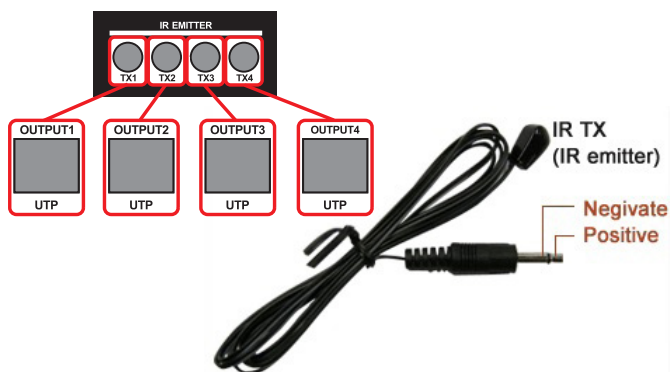

1 At Matrix end: Insert the 3.5mm jacks of the IR TX Emitters included with the unit into the IR TX Emitter ports at the rear of the matrix according to input. The IR signal

is added to the HDMI of the input device so, for example, if the user is watching Blu-ray on input 3, the IR signal will be directed through the IR TX3 socket to control the device.

As each IR TX port is allocated to an individual HDMI input port, if the user is unable to establish IR control of the device, care should be taken to check that, firstly, the IR emitter and HDMI input ports match (Input 1-TX1, Input2-TX2 etc.) with plugs secured in correct ports, and secondly, that the IR TX emitter sensors are firmly attached directly to the front of inputs and covering infrared sensor windows of the source devices.

Some later adjustment may be needed to the location of the sensor to achieve the best performance results - sometimes moving the sensor to different areas on the source can improve IR performance.

HINT Infrared receiving areas of devices can be located by shining a flashlight onto the front of the device – the sensor should be able to be seen through the plastic as a small, round object inside.



RX-1UTP-IR-40

2 At display end: Insert the IR RX Receiver jack into the IR RX port of the RX-1UTP-IR-40 receiver baluns, with the IR receivers themselves placed in clear view on or near the displays to receive an infrared signal from the remote handset used to control inputs. Fasten firmly to the surface to avoid displacement.

Attention Misplaced or poorly secured IR Emitters and Receivers may result in intermittent IR control signals passed to and from the matrix. Check your placement and adjust if necessary.

HINT If problems are encountered controlling devices remotely, check IR TX Emitters and IR RX Receivers are correctly positioned and connected to sources, displays and display receivers, with all devices fully powered and the matrix set to IR call-back enabled and IR TX Switch mode activated. See COM CTL section for Call-back enabling.

IR Extender Control

Front Panel



Rear Panel

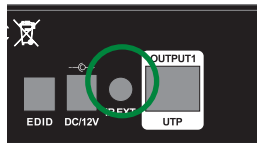

Should local control of the Matrix via the front panel IR sensor be an issue, for example if the sensor is obstructed or the unit is installed in a closed area out of infrared line of sight, the IR RX Receiver included with MX0404-QI can be inserted into the IR EXT port at the rear to extend the IR sensor range and enable local control of the matrix.

11. Advanced Operation

Typically, unless alternative methods of controlling the matrix are chosen or problems with device communication through the matrix encountered, basic operation is all that is required to operate your MX0404-QI. However, the following information on advanced operation will detail how the matrix system can be configured for advanced control and settings altered or data manually input should such problems arise, as well as configuring the system for third party control.

IR Call Back and Third Party Control systems

Attention Due to the differing method of control based on location, if you are using a third party control system, learning the control from the IR is NOT recommended as control will be limited to scrolling up/down between inputs. For discrete source selection you will need to import discrete hex codes for control systems. These can be obtained through the WyreStorm website, by contacting our technical support or you can input them manually.

NOTE The IR is NEC and possesses a carrier wave of 38KHz with a system code of 0x00

Select specific source numbered 1-4

Toggle numerically forwards/backwards through connected source devices

Output port number

| | |
|--|---|
| Output1 source select key code: | 0x80 0x81 0x82 0x83 0x84 0x85 0x86 0x87 |
| Output2 source select key code: | 0x90 0x91 0x92 0x93 0x94 0x95 0x96 0x97 |
| Output3 source select key code: | 0xa0 0xa1 0xa2 0xa3 0xa4 0xa5 0xa6 0xa7 |
| Output4 source select key code: | 0xb0 0xb1 0xb2 0xb3 0xb4 0xb5 0xb6 0xb7 |

RS232 Control

Control of the matrix is possible through RS232 using third party control systems or the dedicated WyreStorm COM CTL software included with your purchase (also downloadable from www.wyrestorm.com). Should third party control be required, please see below for control system configuration and hex code input. The RS232 connection on the matrix is female QB9. Users can use a USB to RS232 cable or a direct male to female serial cable.

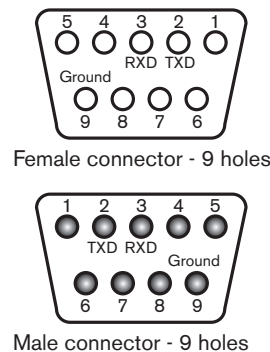

RXD Receive serial data from PC
TXD Transmit serial data to PC

Com Port Setting

| | |
|--------------|---------|
| Baud rate | 9600bps |
| Data bits | 8bits |
| Parity | None |
| Stop bits | 1 |
| Flow control | None |

COM CTL

Control of matrix switching and system settings is possible using the WyreStorm COM CTL software included with your purchase. After fully connecting all inputs and outputs to the matrix and installing the software, on opening the program the control window will display information from the matrix, such as messages received from the switch such as input/output details, firmware version and control commands/HEX codes that allow the system to be controlled remotely, as well as buttons used to navigate the screen.

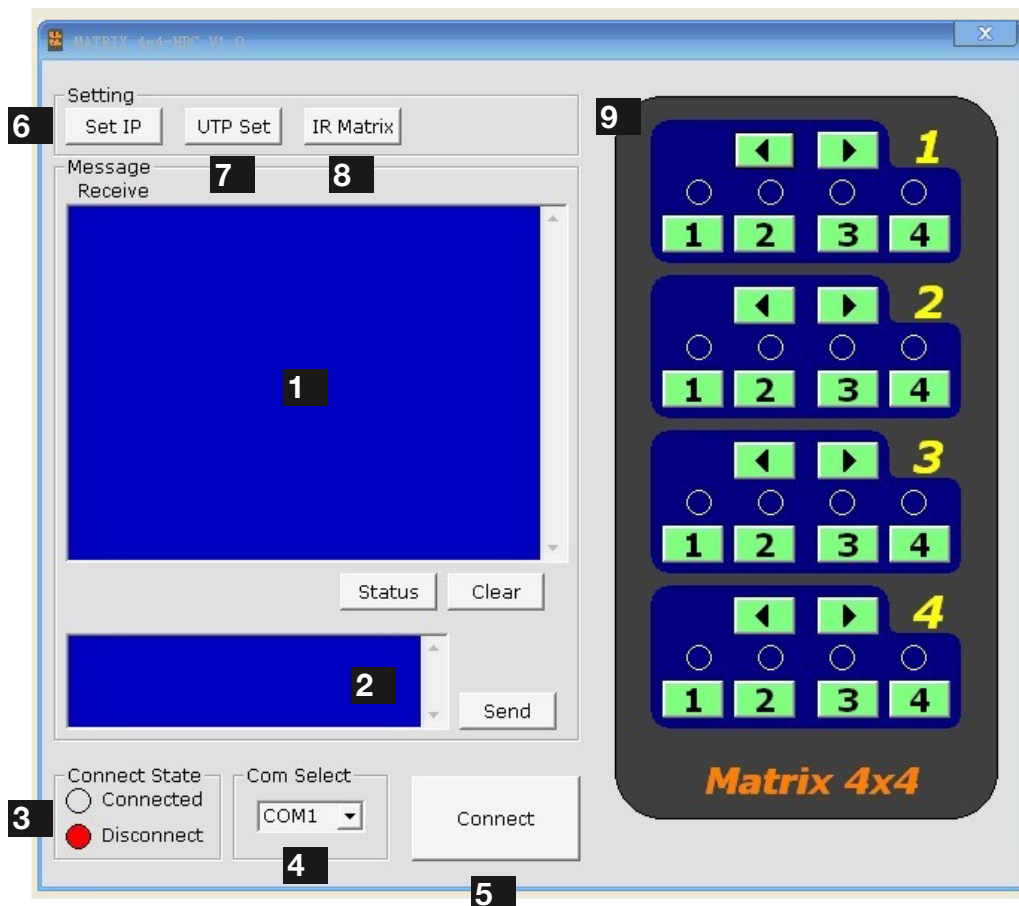

1 Receive Message Window – displays messages received from the matrix, such as input/output settings and command selections. You can view the current condition of all input/output ports by pressing the

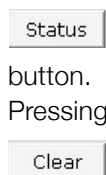

button. Pressing will delete the previous message received in the window.

2 Send Message Window – Input your serial commands for the matrix in the Send Message Window - such as instructions for outputs or to enter update mode – and click the Send button to deliver the message to the Matrix. The control command uses ASCII.

RS232 Control

To update the system firmware, enter the following code into the Send Message Window, ensuring to include one space between each section of the code.

Code: **ICP BE 7C 5F**

Press Enter, then Send Message

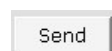

to put the matrix into firmware update mode.

Press the Connect **5** button and run the firmware. When the firmware has finished updating, press the same button again to Connect and powercycle the matrix (turn off and on).

Updates are now active and the firmware is now updated.

Attention To see the firmware version currently used in the system – power off and repower while the matrix is connected to COM CTL. The firmware version and creation date will be displayed together with the normal output state of the matrix.

3 Com Connect State – Shows if the matrix is connected or disconnected to the Com Port and communication is enabled. Selection between ports is available by pressing the Com Port Select button.

When connected, the only option will be to Disconnect and vice versa. Press **5** to connect/disconnect the matrix from the software control.

- Connected to ENABLE matrix communication
- Disconnected to DISABLE matrix communication

4 Com Select

5 Connect/Disconnect

Click the Com Select dropdown to see all Com ports available. Select your chosen Com port number and press the CONNECT button. You will notice the button change to show 'disconnect' and CONNECT STATE change to green for 'connected'. Pressing the button again will disconnect the Com port and the CONNECT state will show red.



NOTE The Com Select drop box offers options of Com Ports to connect to – COM 1-10

6 Set IP Button – allows you to set the IP address to be used by the system.

The matrix can also be controlled over LAN. Selecting the Set IP button **6** in the main COMCTL screen allows access to IP functions that obtains and stores IP address information necessary for LAN control.



Clicking opens a pop-up window in which you can choose to let the system automatically detect your IP address, with the result displayed in the box below. Alternatively, if the system cannot detect an IP address, select 'Use the following IP Address' and you can add manually.

1 Selection enables the IP address to be obtained automatically, with the result appearing in the white box below.

2 Should no address appear or if the system is unable to detect an IP address, select option

3 to manually input the IP address.

4 Click



to complete the process or



to exit and return to the main screen.

NOTE To access matrix control over LAN, enter the IP address of the matrix into your internet browser and you will be directed to the web control screen.

For full information on LAN control, see NETCTL section of this manual.

7 UTP Set – Default setting is OFF for normal Matrix operation to obey device EDID/HDCP commands and high hotplug settings when outputting a signal. Switching output settings to ON instructs the matrix to output a signal regardless of device EDID/HDCP or hotplug data – such information is circumvented to encourage communication in the event of problems between sync devices.

We recommend this setting for system debugging by the installer and not for operation by the end user.

8 IR Matrix – IR Matrix - allows specific SOURCE IR ports to be manually set to individual DISPLAY ports to configure specific IR configurations through the matrix.

This function is available only when the matrix is connected to receivers via UTP and all units fully powered.

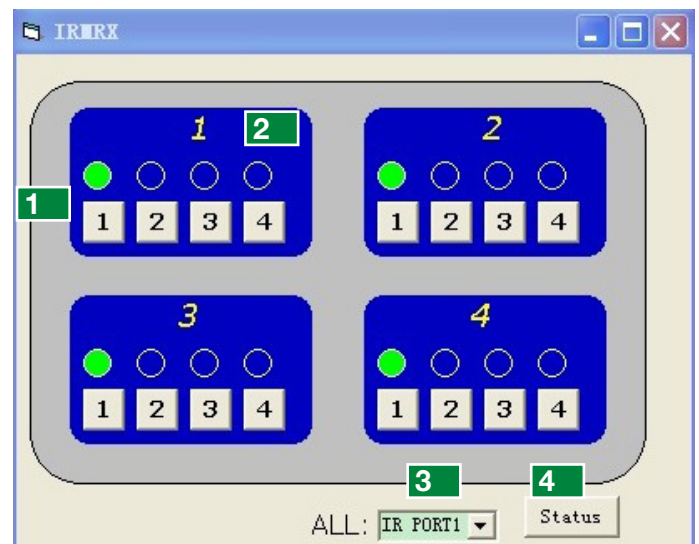

IR Matrix allows manual selection of source device ports **1** by Display Receiver ports **2**

The dropdown menu **3** allows ALL IR TX ports to be set to ONE specific INPUT device IR RX port with the

current settings of the IR Matrix viewable by pressing the

Status

button **4**

9 Input/Output Switch – Switches connected inputs per output.

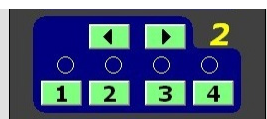

COM CTL
Input/Output selection

Operation as with remote control handset – select the chosen input to be displayed on each output by either clicking the left/right arrow buttons to scroll through inputs numerically, or pressing the input number 1-4.

A large yellow number denotes each OUTPUT section with INPUTS chosen by either clicking the left/right arrow buttons to scroll through inputs numerically or by pressing the input numbers below.

The INPUT/OUTPUT switch allows output port selection (display) and Input port select (source) buttons for specific combinations of displays and sources within the matrix.

NETCTL - LAN Control

The matrix can also be controlled via LAN over a network/web browser using the supplied WyreStorm NET CTL software or LAN protocols from third party companies, such as Control 4 and TELNET Control for all control systems.

As with COM CTL, install the NET CTL software included with the matrix (also downloadable from www.wyrestorm.com) and run the program by double-clicking NETCTL.exe

Attention Use a 'straight through' ethernet cable for switch/router connection and a 'cross-over' cable for connection to a PC. Using the incorrect cable will not damage your equipment, but it may result in poor/no connection.

Make sure that your LAN cable is correctly terminated and firmly connected to ports before running the software.

On initial opening, the program will first create a NETCTL.TXT file that will serve as a device backup for future use; including connection settings such as IP address and MAC address of the MX0404-QI, as well as its name if you decide to change the name of your matrix (see Device Name section below).

On subsequent openings, NETCTL will then search the Matrix for the saved data required for connection.



If using for the first time, the program will automatically detect the IP address being used, with the result displayed in the white area beneath.

Should no result appear or if the system is unable to detect an IP address automatically, press the

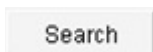

button to locate.

When the IP address appears, click



to attach the IP address to the system and the IP address will change to a default factory serial number MX0404-QI or MX0404-HDC.

Device Name



Should you wish to change the name of your matrix from the factory default, just right click on the serial number and select 'rename' from the dropdown menu. Input the new name and press OK.

Double click on the device name/default factory serial number (or right click and OPEN) and you will be directed to a web login page in your internet browser.

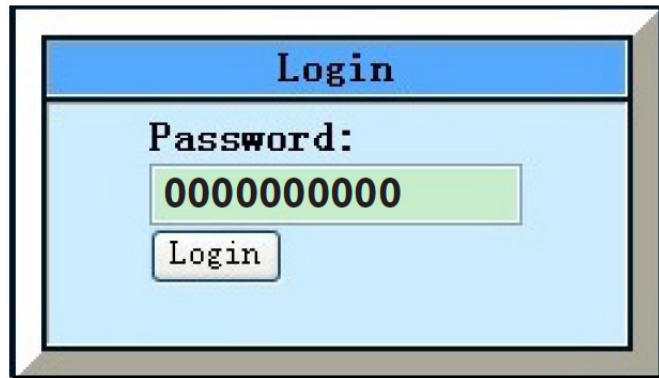
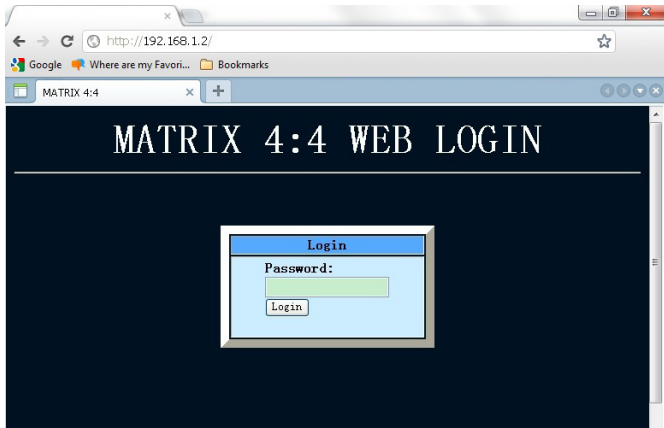

Enter the default password of ten zeros '0000000000' and click

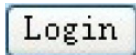

to take you to the NET CTL matrix controller screen.

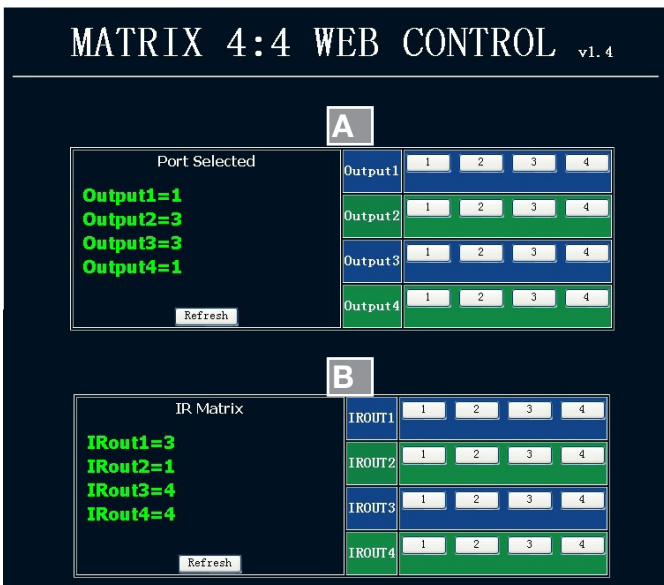

A The layout of the NET CTL controller screen includes an upper section to allocate input sources to output with the selection displayed on the left hand side. Operation is the same as COM CTL – Inputs buttons 1-4 can be clicked to be selected per Output port.

Press the

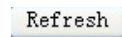

button to update your chosen matrix settings into the left hand display and your selection to take effect.

B The lower section of the NETCTL controller screen is dedicated to IR Matrix settings. As with the IR Matrix screen in COMCTL, the NETCTL IR Matrix allows specific SOURCE IR ports to be manually set to individual DISPLAY ports to configure specific IR configurations through the matrix.

Press the

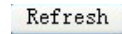

for IR Matrix changes to be set.

This function is available only when the matrix is connected to receivers via UTP and all units fully powered.

TELNET Control

Control of matrix switching and system settings are also possible using Telnet control protocols. Follow system commands below.

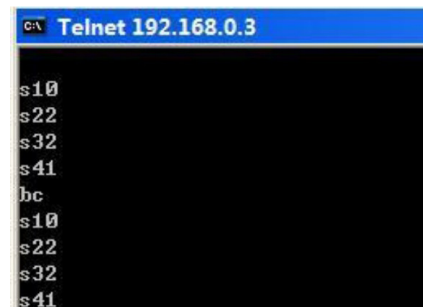
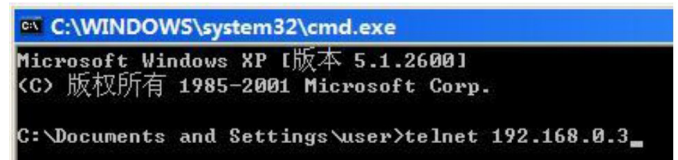

Assign IP

If 'Assign IP' is displayed in the dialog box, the matrix has encountered a problem detecting an IP address and manual input of information is required. In such instances, double click 'Assign IP' or right click and choose Assign IP from the dropdown menu to add details as required.



Click



to assign the new IP address to the system and you will return to the previous screen or

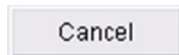

to return without changes taking effect.

Now click

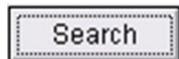

for the Matrix to detect the new IP address, which will appear in the dialog box. Finally click

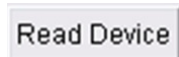

to confirm IP settings

Attention This 'Assign IP' process differs from the COM CTL 'IP Set' function.

'Set IP' in COMCTL saves/reads the IP address in flash and sets it as static IP. 'Assign IP' is only used when the system fails to obtain an IP address automatically and is NOT saved in flash.

MX0404-QI - EDID DIP Switch setting

Distribution of HD signals through the matrix requires mutual communication or 'handshake' between source and display. If there is any disparity between the two, successful transmission becomes problematic.

This matrix comes equipped with an EDID DIP switch on the rear panel for manual adjustment of matrix settings to encourage communication between INPUT and OUTPUT devices. If installation compatibility issues arise, check the settings on your connected devices and adjust the DIP settings as required.

Attention Changes to the DIP switch settings should be made with the matrix OFF, ideally with all power cables and HDMI leads and UTP cables removed to guard against electrostatic build up that may damage your system. DO NOT HOTSWAP your cables when changing DIP SETTINGS.

ALL changes to the DIP settings become effective upon powering ON the matrix.

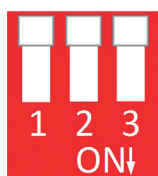

EDID Copy from Output display to Input port (Force Signal Output mode)

To copy the EDID from an OUTPUT display to a specific INPUT port, first set the DIP switch to this position. Then select the INPUT by pressing and holding the chosen OUTPUT SELECT button for 3 seconds for the EDID to be copied from the DISPLAY to the INPUT port.

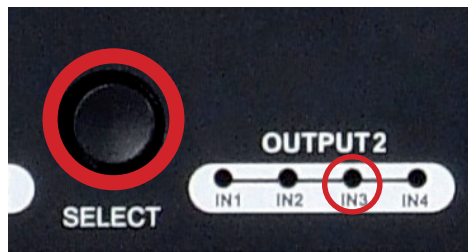

Select the INPUT you wish EDID to be copied onto. PRESS and HOLD the OUTPUT SELECT button for 3 seconds for the OUTPUT EDID to be copied to the selected INPUT



1080p 3D Video / Stereo Audio (using embedded M-series EDID) FACTORY DEFAULT

Setting the DIP switch to this position will instruct the matrix to use embedded 1080p 3D video and Stereo audio to encourage communication between the matrix and 3D sources/3D displays if handshake problems are encountered. After setting the DIP switch, reconnect and turn on for the changes to take effect.

RESETTING TO FACTORY DEFAULT:

As 1080p-3D-Stereo is the default factory setting for the matrix, to reset EDID of all ports, simply set the DIP switch to the above position when the matrix is powered OFF. On powering ON, all ports will revert to 1080p-3D-Stereo and DIP switches can be adjusted as necessary.



1080p Stereo (using embedded A-series EDID)

The matrix will use embedded 1080p video and stereo audio in this DIP setting. After setting the DIP switch, reconnect and turn on for EDID settings to take effect.



1080i Stereo (using embedded L-series EDID)

In instances where a connected display is unable to achieve 1080p resolution (such as using older or cheaper models), this DIP setting will instruct the matrix to use embedded 1080i video and stereo audio to output a signal. After setting the DIP switch, reconnect and turn on for EDID settings to take effect.

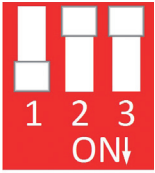

1080p 5.1 Audio (using embedded D-series EDID)

When set to this DIP position the matrix will use embedded 1080p video with 5.1ch Audio. After setting the DIP switch, reconnect and turn on for EDID settings to take effect.

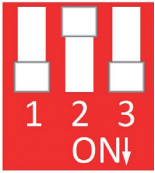

1080p 7.1ch Audio (using embedded G-series EDID)

When set to this DIP position the matrix will use embedded 1080p video with 7.1ch Audio. After setting the DIP switch, reconnect and turn on for EDID settings to take effect.

AVR 7.1 Audio EDID COPY to Blu-ray source (AV Receiver copy)

For users who wish to copy EDID from an AV Receiver with 7.1 channel audio to a specific input port containing a Blu-ray player, follow a variation on the instructions above:

1. Set the DIP switch to the above position with the matrix in the OFF position.
2. Connect the AVR to your desired OUTPUT port on the matrix (for example, OUTPUT 2)
3. Power ON the matrix and select your INPUT on the AVR, making sure your chosen SOURCE is connected to (for example, INPUT 3 – Blu-ray)
4. Press and hold the OUTPUT SELECT button for 3 seconds for the EDID data to be copied from OUTPUT 2 (AVR) to INPUT 3 (Blu-ray).

Remaining settings no function (reserved for future updates)

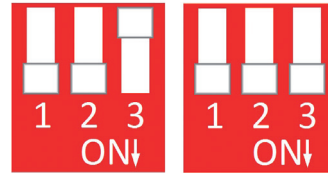

RX-1UTP-IR-40 - EQ Distance Adjustment Settings

Occasionally, the installation environment, such as the distance between source and display may be a factor in the perfect transmission and reception of a signal. In addition to the MX0404-QI LONG CABLE settings on the Matrix DIP switch, the EX-1UTP-IR-40 RECEIVER balun can be further fine tuned depending on the length of Cat5e/6/7 cable used for optimum performance.

Attention Please ensure the balun is switched OFF when changing the dial to desired distance setting.

Changes become effective when turned back ON.

| Position | Functions |
|-------------|---|
| 0 | 0-5m Transmission distance |
| 1 | 5-10m Transmission distance |
| 2 | 10-15m Transmission distance |
| 3 | 15-12m Transmission distance |
| 4 | 20-25m Transmission distance |
| 5 | 25-30m Transmission distance |
| 6 | 30-35m Transmission distance |
| 7 (default) | 35-40m Transmission distance. Default position 7 recommended for initial connection and operation. If signal requires fine-tuning, move through the following settings until desired image quality is achieved. |
| 8 to F | No function - settings reserved for future updates |

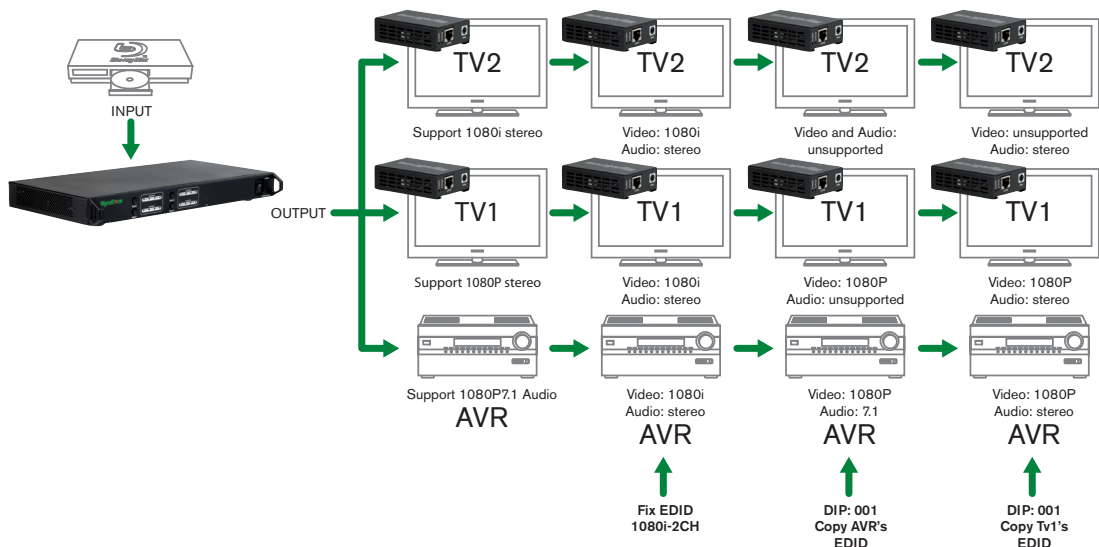

12. Troubleshooting

Generally, the majority of HD distribution installation issues are either caused by minor connection errors, communication problems between devices, or when the transmission of high signal bandwidth is attempted using insufficient cable. Should you encounter any technical difficulties when installing and configuring the matrix, we are confident solutions can be found by working through the following troubleshooting checklist before seeking alternative technical support.

No Picture or poor quality picture

1) Power – are your HDBaseT transmitter or display receiver baluns powered both ends? Transmitters and receivers should have their own power source i.e. the 5v power adaptors included with your baluns.

Are all sources definitely powered and firmly connected?

2) If possible, always use test equipment prior to installation and to troubleshoot any problems.



Test Monitor

Part Number TTMONITOR



Signal Generator

Part Number TTSIGNAL

3) Distance – Is your cable too long for the signal to be transmitted effectively? The QI System allows transmission of 1080p up to 40m (131ft) so make sure you cable distance matches your requirements and is well within the maximum transmission distance of the signal.

Note: If you are approaching the limits of the transmission capabilities, you will need to use a WyreStorm Extender set for the signal to transmit effectively.

4) Cable joins? Joins in your cable run can impact on signal strength, resulting in reduced transmission that may manifest itself in poor picture quality or a complete lack of picture.

5) Signal Reduction – Are you using stranded patch leads as interconnects between patch panels or wall outlets? Such use reduces signal strength – we recommend solid core straight through connections to be used wherever possible.

6) Resolution – If you reduce the resolution of the source, do you get a picture? If so, this suggests a discrepancy between source and display resolution or a bandwidth capacity issue with your cable. Check that your inputs and outputs share the same resolution and that the signal is being successfully transmitted along your cable run.

7) Correct connection – It may seem obvious but double check all UTP, HDMI, power and IR cables are connected to the correct ports. Even a fraction off can be the difference between a perfect picture and a blank screen. Double check all connections are firmly made in the correct ports.

9) Cable wired to 568B standard? Is your cable wired and terminated correctly and are those terminations connected to the correct ports?

10) Electrical interference – HD transmissions are susceptible to electrostatic interference so locations of cables and devices should be considered

11) Do you get a picture if you connect the source directly to the display? If not then the problem could lie with the input or output device rather than the means of distribution i.e. the cable or matrix itself.

12) HDMI lead condition and quality – HDMI cables and connectors are delicate and can be damaged much easier than component or coax cable. Furthermore, lead quality varies dramatically, particularly in lower price brackets. Swap your HDMI leads and check operation – damage to or quality of your leads could be the problem. If in doubt, swap them over. Always take care inserting and extracting your HDMI from matrix ports so as not to damage the connectors or ports.

13) Picture snow/HD 'noise' – represents a poorly established signal that may be caused by poor quality

terminations or excessive cable lengths. Try swapping the display adaptors from a location you know is functioning properly or swapping the outputs of the matrix switch used.

If the problem remains on the same screen this may be caused by a connection problem between matrix and display – turn off all equipment and swap the signal carrying cables at both ends to ascertain if the cable or termination is at fault.

14) Blu-ray: Deep Colour – make sure Deep Colour is turned on in your Blu-ray settings and displays.

15) Blu-ray: Resolution – if a reduction of resolution to 720/1080i produces an image, cable issues such as interference, patch panels, wall outlets, stranded cable use or excessive cable length are likely restricting transmission of a full 1080p signal.

16) Blu-ray: 3D – is the equipment used 3D enabled/compatible? Is a 3D disc being played in a 3D enabled Blu-ray player or through a compatible amplifier?

17) Colour distortion – a pink or green screen indicates an incompatibility between colour spacing formats – the commonly used RGB or YUV used by older displays. Some sources allow switching between RGB and YUV which may solve any colour problems. If not, try changing the HDMI cable between the source and the matrix to rule out defective cabling.

Audio is transmitted within the video signal – there is no separate audio track – so generally a problem with sound will be accompanied by a problem with picture. However, if technical issues with audio are experienced, the cause is typically communication between sources, displays and/or AV receiver settings.

No sound or poor quality audio

1) If using an AV receiver, check your source input assignment – do you have specific speaker sets or zones enabled? Some AV receivers allow individual speaker selections assigned to specific zones in the set up so check the speakers used are fully connected to the amplifier and correctly assigned within the system set up.

Note: If you experience problems when an AV receiver is used, the cause is usually the settings of the AVR itself. Refer to the AVR manufacturer's guidelines on the correct settings to use for your requirements.

2) Consistency of audio output between devices – Is there any discrepancy between the audio output of the source, the audio or zonal settings of the AV receiver and the speaker configuration used needed for successful audio replication? If you are outputting 7.1, make sure all devices connected are also outputting 7.1

Note: Occasionally with some sources, the device settings allow the specification of audio output through a TV or an HDMI port. If using an AV receiver, check the HDMI output option is selected.

3) Do all the local sources work through the AV receiver?

Check the operation of each source individually.

Bandwidth

1) If using a graphics-based source (such as a PC/Mac/media server), make sure the source resolution is set to a maximum of 1080p, 50Hz. Higher resolutions available for graphics-based systems require higher bandwidth that may affect transmission of signals as well as incompatibility with devices.

IR

1) Check you are using emitters at the IR TX transmitter end and receivers at the IR RX receiver end – are they connected to the correct ports on the matrix and display receiver.

2) Is the emitter correctly positioned on the source?

Fix the emitter directly over the infrared sensor of the source and attach using the adhesive backing.
Note: Locate the infrared source sensor by using a flashlight to find a small sensor within the fascia of the source display. If necessary, secure the emitter over the sensor with a small amount of contact adhesive.

3) Is your remote powered and sending a signal?

IR is invisible to the naked eye, so use a digital camera/phone camera to check the remote signal – point the camera at the remote control when pressing a button. You should see the remote transmitter flashing to indicate a signal being sent. Replace batteries if flashing is not seen on the digital camera screen.

4) IR dropout issues can be due to exterior influences emitting infrared radiation that can interrupt IR signals. Ensure emitters and receivers are away from the following causes of IR interference.

- **Direct sunlight**
- **Halogen lighting**
- **Plasma screens**

5) UTP Termination Issues - swap cables over at both transmitter and receiver ends to see if control is established. If so, a possible re-termination of the cable could remedy the problem.

6) Are you using WyreStorm emitters and receivers? The use of third party products/magic eyes may not be compatible. Always use WyreStorm components included with your purchase or check compatibility of third party control systems with your WyreStorm dealer.

7) If problems persist, swap out the IR emitters and receivers to rule out faults with the units themselves. Use emitters you know are fully operational to test working condition.

8) Reactivate the IR callback function on your matrix and swap IR ports on the matrix to rule out a fault with the matrix or connection ports.

9) Should IR remain unresponsive, turn off and disconnect all cables from the matrix and reconnect zones one at a time to assess if one location in particular is the problem. If so, run new cables directly to the display – if this fixes the problem, it is likely that electromagnetic interference /damage to the cable somewhere along the run is causing the IR signal to drop out. Investigate and remove EM interference from the run or replace damaged UTP cable.

13. FAQ's

5e or 6?

While our equipment is tested and graded to Cat 5e cable standard; tests have shown that better results are achieved when using Cat6 cable. The lower gauge, thicker copper cores ensure better signal transfer. Newly installed cabling should always conform to Part P Regulation and BS 7671 (17th Edition), and should be terminated to 568B standard

Can I use a single Cat 5e cable?

Although conventional transmission is considered to be two Cat5e cables, it is possible to send the signal down a single cable if necessary. All of our pro-matrix switches and UTP splitters support single UTP mode, however in this mode IR control of sources and matrix switching is

not possible.

However using HDBaseT transmission; all of the twin cable features are supported with the added benefit of Ethernet and RS232 control.

How far can the signal travel?

Under perfect transmission conditions our HD receivers will operate at 30, 50 or 100m (@1080p) depending on the model used. Perfect conditions mean no electrical interference, straight cable runs with no bends or kinks and no patch panels or wall outlets. If some of the above are factors in your installation then signal strength and bandwidth can be compromised. If a cable run is reaching the upper limit of the receivers' capabilities, then the signal can be boosted by way of an extender set (Rx TX) or by simply using an in-line repeater. Our transmission signals can be repeated up to 5 times (250m) using a conventional TMDS signal or 7 times (700m) using HDBaseT technology.

What about 3D?

All of our matrix switches and most of our extender products will pass-through a 3D Blu-ray signal. The 30m and Coax extender sets do not support frame sequential 3D (Blu-ray), but will still pass-through interlaced stereoscopic 3D (Satellite etc.)

How do I control the sources?

Most of our HDMI distribution products support some kind of IR pass-through from point-to-point extender sets to pro and HDBaseT matrices. Most of the range now supports wideband IR meaning it is compatible with any IR device available on the market. Our Pro and HDBaseT matrix range (Cat 5e) has IR pass-through from each of the outputs and has discrete IR outputs at the switch end, meaning you can have multiple identical sources yet the IR would be routed only to the applicable source.

Do I need power at the TV end?

Yes. Our HD display adaptors require a 5v power supply at the TV end to operate. It's important that these are powered locally and do not receive remote power from the rack as there can be issues resulting from voltage drop along the length of cable.

Are WyreStorm products compatible with HDMI 1.4?

HDMI 1.4 refers to a list of 'features' that a device is capable of supporting, including Ethernet channel, return audio channel, 3D etc. Due to the continuously evolving nature of the technology, HDMI Licensing LLC have now decided to simplify terminology by testing and referring to cable in terms of STANDARD or HIGH-SPEED rather than

in generations 1.3, 1.4 etc.

- STANDARD (or “category 1”) HDMI cables perform at speeds of 75Mhz or up to 6.75Gbps, which is the equivalent to a 720p/1080i signal.
- All WyreStorm equipment support HIGH-SPEED (or “category 2”) HDMI cables that have been tested to perform at speeds of 340Mhz or up to 10.2Gbps, which is the highest bandwidth currently utilised over an HDMI cable and can successfully handle 1080p signals including those at increased color depths and/ or increased refresh rates from the Source. High-Speed cables are also able to accommodate higher resolution displays, such as WQXGA cinema monitors (resolution of 2560 x 1600).

What about screens with different resolution capabilities?

When sending a signal point to point a TV will communicate it’s capabilities to the source, then the source will output a suitable signal that compatible (i.e. 1080p Stereo audio). If you were to use a matrix switch with three 1080p screens and one 1080i screen, the resultant image would be 1080i across all screens. The matrix switches do not scale per output but instead negotiate with the source a signal that all screens are capable of supporting.

How does the Matrix cope with HDCP?

HDCP (High Definition Copyright Protection) is a feature built in to HDMI devices to prevent theft of or illegal distribution of HD content. Unlike competing products, WyreStorm matrix switches are legal and comply with HDCP regulations. They do this by assigning a “key” to every display connected to the switch. HDCP “keys” are assigned to a display when connected to a HDMI device normally. This doesn’t change when connected to a switch; it just assigns more of them.

I can get 1080i but not 1080p at a TV location

Firstly ensure that both the source is outputting 1080p and that the TV is Full HD 1080p screen. If this is the case then the receiver Cat 5e or Coax may need setting up for long cable mode using the DIP switches. This useful feature uses an alternative Equalisation method to re-sync the signal over longer distances.

I cannot get a signal out from my A/V receiver along a Cat 5e extender set

Check to ensure that the A/V Receiver isn’t adding CEC (HDMI Control Protocol) to the outgoing signal, this can sometimes have an effect on the HDMI signal.

14. Maintenance

Clean this unit with a soft, dry cloth only. Never use alcohol, paint thinner or other harsh chemicals.

15. Provided Service

Provided Service:

1. Damage requiring service: This unit should be serviced by a qualified service personnel if:

- The DC power supply or AC adaptor has been damaged.
- Objects or liquid have gotten into the unit.
- The unit has been exposed to rain.
- The unit does not operate normally or exhibits a marked change in performance.
- The unit has been dropped or the cabinet damaged.

2. Servicing Personnel: Do not attempt to service the unit beyond that described in these operating instructions. Refer all other servicing to authorised servicing personnel.

3. Replacement Parts: When parts need replacing, ensure parts approved by the manufacturer are used – either those specified by the manufacturer or parts possessing the same characteristics as the original parts. Be aware – unauthorised substitutes may result in fire, electric shock, or other hazards and will invalidate your warranty.

4. Safety Check: After repairs or service, ask the service personnel to perform safety checks to confirm the unit is in proper working condition.

16. Mail-in-service

When shipping the unit, carefully pack and send it prepaid, with adequate insurance and preferably in the original packaging. Please include a document or letter detailing the reason for return and include a daytime telephone number and/or email address where you can be contacted.

If repair is required during the limited warranty period, the purchaser will be required to provide a sales receipt or other proof of purchase, indicating date and location of purchase as well as the price paid for the product. The customer will be charged for the repair of any unit received unless such information is provided.

17i. Warranty

Should you feel your product does not function adequately due to defects in materials or workmanship, we (referred to as “the warrantor”) will, for the length of the period indicated below (starting from the original date of purchase) either:

- a) Repair the product with new or refurbished parts.
- or
- b) Replace it with a new or refurbished product.

Limited warranty period:

All WyreStorm products are covered by a 2 year PARTS and LABOUR warranty. During this period there will be no charge for unit repair, replacement of unit components or replacement of product if necessary.

The decision to repair or replace will be made by the warrantor. The purchaser must mail-in the product during the warranty period. This limited warranty only covers the product purchased as new and is extended to the original purchaser only. It is non-transferable to subsequent owners, even during the warranty period.

A purchase receipt or other proof of original purchase date is required for the limited warranty service.

under “limited warranty coverage.” The warrantor is not liable for incidental or consequential damage resulting from the use of this product or arising out of any breach of this warranty.

For example: damages for lost time, the cost of having a person/persons remove or re-install previously installed equipment, travel to and from service location, loss of or damage to media, images, data or other recorded/stored content. The items listed here are not exclusive, but are for illustration only.

Parts and service not covered by this limited warranty are not the responsibility of the warrantor and should be considered the responsibility of the individual.

17ii. Warranty Limits and Exclusions

1. This Limited Warranty ONLY COVERS failures due to defects in materials or workmanship and DOES NOT COVER normal wear and tear or cosmetic damage.

The limited warranty also DOES NOT COVER damage that occurs in shipment or failures caused by products not supplied by the warrantor, failures resulting from accident, misuse, abuse, neglect, mishandling, misapplication, alteration, incorrect installation, set-up adjustment, implementation of/to consumer controls, improper maintenance, power line surge, lightning damage, modification, service by anyone other than a manufacturer-approved service centre or factory-authorised personnel, or damage attributable to acts of God.

2. There are no express warranties except as listed

18. Installation Notes

WyreStorm MX0404-QI Installation Reference Log (INPUT)

| INPUT | | | | |
|------------------------|-----------------|----------------|------------------------------------|--------------|
| Input number on Matrix | Source Location | Source Details | Source resolution & audio settings | Cable Number |
| 1 | | | | |
| 2 | | | | |
| 3 | | | | |
| 4 | | | | |

WyreStorm MX0404-QI Installation Reference Log (OUTPUT)

| OUTPUT | | | | |
|-------------------------|-----------------|-----------------|-------------------------------------|--------------|
| Output number on Matrix | Output Location | Display Details | Display Resolution & Audio Settings | Cable Number |
| 1 | | | | |
| 2 | | | | |
| 3 | | | | |
| 4 | | | | |



www.wyrestorm.com

■ WyreStorm Offices

US Office: 6991 Appling Farms Parkway, Suite 104, Memphis, TN 38133

Tel: + 901 384 3575 Fax: + 901 384 3574

Unit 22, Ergo Business Park, Swindon, Wiltshire, SN3 3JW UK

Tel: +44 (0) 1793 230 343 Fax: +44 (0) 1793 230 583

■ WyreStorm Technical Support

US: +86 6677 0053

UK:- +44 (0) 1793 238 338

Email: support@wyrestorm.com

We reserve the right to change specification or product dimensions at any time.