

visual engineering
LIGHTWARE

User's Manual

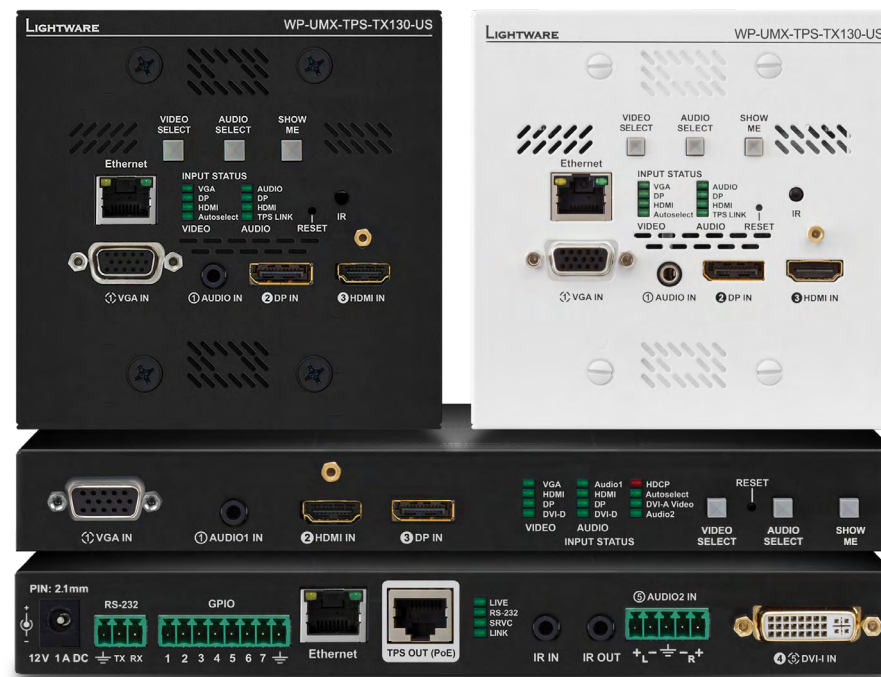

UMX-TPS-TX120, -TX130, -TX140, -TX140K, -TX140-Plus
FP-UMX-TPS-TX120, -TX130
WP-UMX-TPS-TX120-US Black, White
WP-UMX-TPS-TX130-US Black, White
WP-UMX-TPS-TX130-Plus-US Black, White

HDBaseT™ Multimedia Extender

Important Safety Instructions

Class II apparatus construction.

The equipment should be operated only from the power source indicated on the product.

To disconnect the equipment safely from power, remove the power cord from the rear of the equipment, or from the power source. The MAINS plug is used as the disconnect device, the disconnect device shall remain readily operable.

There are no user-serviceable parts inside of the unit. Removal of the cover will expose dangerous voltages. To avoid personal injury, do not remove the cover. Do not operate the unit without the cover installed.

The appliance must be safely connected to multimedia systems. Follow instructions described in this manual.

Ventilation

For the correct ventilation and to avoid overheating ensure enough free space around the appliance. Do not cover the appliance, let the ventilation holes free and never block or bypass the ventilators (if any).

WARNING

To prevent injury, the apparatus is recommended to securely attach to the floor/wall or mount in accordance with the installation instructions. The apparatus shall not be exposed to dripping or splashing and that no objects filled with liquids, such as vases, shall be placed on the apparatus. No naked flame sources, such as lighted candles, should be placed on the apparatus.

Waste Electrical & Electronic Equipment WEEE

This marking shown on the product or its literature, indicates that it should not be disposed with other household wastes at the end of its working life. To prevent possible harm to the environment or human health from uncontrolled waste disposal, please separate this from other types of wastes and recycle it responsibly to promote the sustainable reuse of material resources. Household users should contact either the retailer where they purchased this product, or their local government office, for details of where and how they can take this item for environmentally safe recycling. Business users should contact their supplier and check the terms and conditions of the purchase contract. This product should not be mixed with other commercial wastes for disposal.



Common Safety Symbols

Symbol	Description
	Direct current
	Alternating current
	Double insulation
	Caution, possibility of electric shock
	Caution

Symbol Legend

The following symbols and markings are used in the document:

WARNING! Safety-related information which is highly recommended to read and keep in every case!

DIFFERENCE: Feature or function that is available with a specific firmware/hardware version or product variant.

ATTENTION! Useful information to perform a successful procedure; it is recommended to read.

INFO: A notice which may contain additional information. Procedure can be successful without reading it.

DEFINITION: The short description of a feature or a function.

TIPS AND TRICKS: Ideas which you may have not known yet but can be useful.

Navigation Buttons

⏪ Go back to the previous page. If you clicked on a link previously, you can go back to the source page by the button.

🏠 Navigate to the Table of Contents.

⏪ Step back one page.

⏩ Step forward to the next page.

Document Information

This User's Manual applies to the following versions of the mentioned software, firmware, and hardware:

Item		Version
Lightware Device Controller (LDC) software		1.34.2b1
Lightware Device Updater V2 (LDU2) software		2.1.1b3
Controller firmware	UMX-TPS-TX100 series	1.4.0
	WP-UMX-TPS-TX100 series	1.4.0
	FP-UMX-TPS-TX100 series	1.4.0
Hardware	UMX-TPS-TX100 series	2.0
	WP-UMX-TPS-TX100 series	1.2
	FP-UMX-TPS-TX100 series	1.2

Document revision: **2.4**

Release date: 25-02-2019

Editor: Judit Barsony

About Printing

Lightware Visual Engineering supports green technologies and eco-friendly mentality. Thus, this document is made for digital usage primarily. If you need to print out few pages for any reason, follow the recommended printing settings:

- Page size: A4
- Output size: Fit to page or Match page size
- Orientation: Landscape

TIPS AND TRICKS: Thanks to the size of the original page, a border around the content (gray on the second picture below) makes possible to organize the pages better. After punching the printed pages, they can be placed easily into a ring folder.

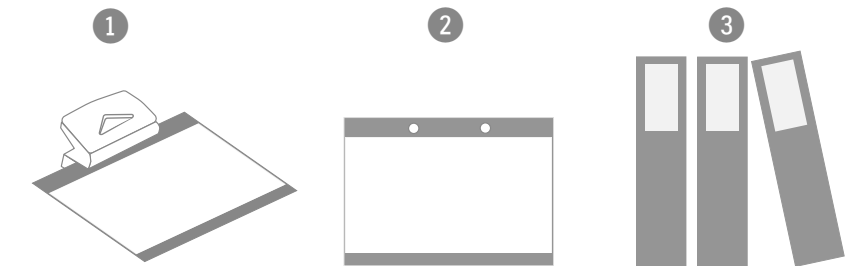

Hashtag (#) Keywords in the Document

This user's manual contains keywords with hashtag (#) to help you to find the relevant information as quick as possible.

The format of the keywords is the following:

#<keyword>

The usage of the keywords: use the **Search** function (Ctrl+F / Cmd+F) of your PDF reader application, type the # (hashtag) character and the wished keyword.

The **#new** special keyword indicates a new feature/function that has just appeared in the latest firmware or software version.

Example

#dhcp

This keyword is placed at the DHCP setting command in the LW3 Programmer's reference section.

Table of Contents

1. INTRODUCTION	7	3.7.11. IR Connector	28	4.2. REAR PANEL LEDs	40
1.1. DESCRIPTION	7	3.7.12. IR Detector	28	4.2.1. LIVE LED	40
1.2. COMPATIBLE DEVICES	7	3.7.13. GPIO - General Purpose Input/Output Ports	29	4.2.2. RS-232 LED	40
1.3. MODEL DENOMINATION	7	3.7.14. USB Port	29	4.2.3. SRVC LED	40
1.4. BOX CONTENTS	8	3.8. TPS EXTENDER CONCEPT	29	4.2.4. USB KVM LED	40
1.4.1. UMX-TPS-TX100 series	8	3.9. TPS INTERFACE	30	4.2.5. LINK LED	40
1.4.2. WP-UMX-TPS-TX100 series	8	3.10. PORT DIAGRAMS	30	4.3. FRONT PANEL BUTTONS	41
1.4.3. FP-UMX-TPS-TX100 series	8	3.10.1. Standalone Extenders	30	4.3.1. Video Select Button	41
1.5. FEATURES	9	3.10.2. Wall Plate / Floor Plate Extenders	31	4.3.2. Audio Select Button	41
1.6. MODEL COMPARISON	10	3.11. VIDEO INTERFACE	31	4.3.3. Port Legend	41
1.7. TYPICAL APPLICATION	11	3.11.1. Video Input Modes	31	4.3.4. Programmable Show Me Button	41
2. INSTALLATION	12	3.11.2. Input Source Selection Modes	31	4.4. SPECIAL FUNCTIONS	41
2.1. MOUNTING OPTIONS - STANDALONE TRANSMITTERS	12	3.12. THE AUTOSELECT FEATURE	31	4.4.1. Enable DHCP (Dynamic) IP Address	41
2.1.1. Under-desk Double Mounting Kit	12	3.13. AUDIO INTERFACE	32	4.4.2. Reset to Factory Default Settings	42
2.1.2. 1U High Rack Shelf	12	3.13.1. Audio Input Modes	32	4.4.3. Resetting the Device	42
2.2. MOUNTING OPTIONS - FLOOR PLATES	13	3.13.2. Audio Options - Example	33	4.4.4. Control Lock	42
2.2.1. MKM Mounting Option	13	3.14. SERIAL INTERFACE	33	4.4.5. Entering Firmware Upgrade Mode	42
2.2.2. MKS Mounting Option	15	3.14.1. Technical Background	33	4.5. SOFTWARE CONTROL MODES	42
2.2.3. GES Mounting Option	16	3.14.2. RS-232 Signal Transmission – Example	34	5. SOFTWARE CONTROL - LIGHTWARE DEVICE CONTROLLER	43
2.3. MOUNTING OPTIONS - WALL PLATES	20	3.14.3. RS-232 Recognizer	34	5.1. INSTALL AND UPGRADE	43
2.4. CONNECTING STEPS	21	3.15. IR INTERFACE	35	5.2. RUNNING THE LDC	43
2.4.1. FP/WP-UMX-TPS-TX100 series	21	3.15.1. Technical Background	35	5.3. CONNECTING TO A DEVICE (DEVICE DISCOVERY WINDOW)	44
2.4.2. UMX-TPS-TX100 series	21	3.15.2. IR Signal Transmission - Example 1	35	5.4. CROSSPOINT MENU	45
2.5. POWERING OPTIONS	22	3.15.3. IR Signal Transmission - Example 2	35	5.5. PORT PROPERTIES WINDOWS	46
3. PRODUCT OVERVIEW	23	3.15.4. Advanced IR functionality	36	5.5.1. Analog Video Inputs	46
3.1. FRONT VIEW - UMX-TPS-TX100 SERIES	23	3.16. GPIO INTERFACE	36	5.5.2. Digital Video Inputs	46
3.2. REAR VIEW - UMX-TPS-TX100 SERIES	24	3.16.1. Description	36	5.5.3. CEC Command Sending	47
3.3. FRONT VIEW - WP-UMX-TPS-TX100 SERIES	25	3.16.2. GPIO Options - Example	36	5.5.4. TPS Video Output	48
3.4. REAR VIEW - WP-UMX-TPS-TX100 SERIES	26	3.17. ETHERNET CONTROL INTERFACE	36	5.5.5. Analog Audio Inputs	48
3.5. FRONT VIEW - FP-UMX-TPS-TX100 SERIES	26	3.18. USB INTERFACE (KVM FUNCTION)	36	5.5.6. Digital Audio Inputs	49
3.6. REAR VIEW - FP-UMX-TPS-TX100 SERIES	27	3.19. CONSUMING ELECTRONIC CONTROL (CEC) INTERFACE	37	5.5.7. TPS Audio Output	49
3.7. ELECTRICAL CONNECTIONS	27	3.20. FURTHER BUILT-IN FEATURES	38	5.6. DIAGNOSTIC TOOLS	49
3.7.1. Locking 12V DC Connection	27	3.20.1. Automatically Launched Actions – The Event Manager	38	5.6.1. Cable Diagnostics	49
3.7.2. 48V DC Connection	27	3.20.2. Transmitter Cloning – Configuration Backup and Restore	38	5.6.2. Test Pattern	50
3.7.3. VGA Connector	27	3.20.3. Remote Firmware Upgrade of Connected Lightware Devices	38	5.6.3. Frame Detector	51
3.7.4. HDMI Connector	27	4. OPERATION	39	5.7. EDID MENU	51
3.7.5. DisplayPort Connector	27	4.1. FRONT PANEL LEDs	39	5.7.1. EDID Operations	52
3.7.6. DVI-I Connector	27	4.1.1. Video Input LEDs	39	5.7.2. EDID Summary Window	52
3.7.7. Analog Stereo Audio (Jack)	28	4.1.2. Audio Input LEDs	39	5.7.3. Editing an EDID	53
3.7.8. Analog Stereo Audio (Phoenix)	28	4.1.3. Autoselect LED	39	5.7.4. Creating an EDID - Easy EDID Creator	53
3.7.9. Ethernet Connector (TPS and LAN Ports)	28	4.1.4. HDCP LED	39	5.8. CONTROL MENU	54
3.7.10. RS-232 Connector	28	4.1.5. TPS LINK LED	40	5.8.1. RS-232 Tab	54
		4.1.6. Firmware Version Indication	40	5.8.2. Message Recognizer	54

Table of Contents

5.8.3. GPIO Tab	55	6.3.7. View Crosspoint Size.....	69	7.4.4. Disconnect Video Input.....	79
5.8.4. Ethernet.....	56	6.3.8. Change Video Autoselect Mode.....	69	7.4.5. Switching Video Input	79
5.8.5. Infra Tab	56	6.3.9. Change Audio Autoselect Mode.....	69	7.4.6. Query the Video Autoselect Settings.....	79
5.9. EVENT MANAGER.....	59	6.3.10. Change the Video Input Priorities.....	70	7.4.7. Change the Autoselect Mode	80
5.9.1. The Event Editor.....	59	6.3.11. Change Audio Input Priority.....	70	7.4.8. Query the Input Port Priority	80
5.9.2. Create or Modify an Event.....	60	6.4. NETWORK CONFIGURATION	70	7.4.9. Change the Input Port Priority	80
5.9.3. Special Tools and Accessories.....	60	6.4.1. Query the Current IP Status	70	7.4.10. Mute an Input Port.....	80
5.9.4. Clear One or More Event(s).....	61	6.4.2. Set the IP Address.....	70	7.4.11. Unmute an Input Port.....	80
5.9.5. Export and Import Events	61	6.4.3. Set the Subnet Mask	70	7.4.12. Lock an Input Port.....	81
5.9.6. Event Creating - Example.....	61	6.4.4. Set the Gateway Address.....	71	7.4.13. Unlock an Input Port.....	81
5.10. SETTINGS MENU.....	62	6.4.5. Apply Network Settings.....	71	7.4.14. Mute Output.....	81
5.10.1. Status.....	62	6.5. GPIO CONFIGURATION.....	71	7.4.15. Unmute Output	81
5.10.2. Network.....	62	6.5.1. Set Level and Direction for Each Pins	71	7.4.16. Lock Output	81
5.10.3. Backup	62	6.6. LW2 COMMANDS – QUICK SUMMARY	72	7.4.17. Unlock Output.....	81
5.10.4. Front Panel.....	63	7. LW3 PROGRAMMERS' REFERENCE.....	73	7.4.18. HDCP Setting (Input Port).....	81
5.10.5. System	63	7.1. OVERVIEW	73	7.4.19. Test Pattern Generator Mode	82
5.11. CONFIGURATION CLONING (BACKUP TAB).....	64	7.2. PROTOCOL RULES	73	7.4.20. Test Pattern Color	82
5.11.1. Steps in a Nutshell	64	7.2.1. LW3 Tree Structure and Command Structure (examples).....	73	7.4.21. Test Pattern Resolution	82
5.11.2. Save the Settings of a Device (Backup).....	64	7.2.2. General Rules.....	73	7.4.22. HDCP Setting (Output Port).....	83
5.11.3. Upload the Settings to a Device (Restore).....	64	7.2.3. Command Types.....	74	7.4.23. HDMI Mode Settings (Output Port).....	83
5.12. ADVANCED VIEW WINDOW	65	7.2.4. Prefix Summary	74	7.4.24. Color Space Setting (Output Port).....	83
6. LW2 PROGRAMMER'S REFERENCE.....	66	7.2.5. Error Messages.....	74	7.4.25. Query the Recent TPS Mode.....	83
6.1. LW2 PROTOCOL DESCRIPTION.....	66	7.2.6. Escaping.....	74	7.4.26. TPS Mode Settings.....	84
6.2. GENERAL LW2 COMMANDS.....	66	7.2.7. Signature	75	7.5. AUDIO PORT SETTINGS.....	84
6.2.1. View Product Type.....	66	7.2.8. Subscription.....	75	7.5.1. Query the Status of Source Ports.....	84
6.2.2. Query Control Protocol.....	66	7.2.9. Notifications about the Changes of the Properties	75	7.5.2. Query the Status of Destination Port	85
6.2.3. View Firmware Version of the CPU	67	7.2.10. Legend for the Control Commands.....	75	7.5.3. Query the Audio Crosspoint Setting	85
6.2.4. Connection Test.....	67	7.3. SYSTEM COMMANDS.....	76	7.5.4. Switching Audio Input	85
6.2.5. View Serial Number	67	7.3.1. Query the Product Name.....	76	7.5.5. Query the Audio Autoselect Settings	86
6.2.6. Compile Time.....	67	7.3.2. Set the Device Label.....	76	7.5.6. Change the Autoselect Mode	86
6.2.7. View Installed Board.....	67	7.3.3. Query the Serial Number.....	76	7.5.7. Query the Input Port Priority	87
6.2.8. View Firmware for All Controllers.....	67	7.3.4. Query the Firmware Version	76	7.5.8. Change the Input Port Priority	87
6.2.9. Restart the Device	67	7.3.5. Resetting the Device.....	76	7.5.9. Mute an Audio Input.....	87
6.2.10. Query Health Status	67	7.3.6. Restore the Factory Default Settings	76	7.5.10. Unmute an Audio Input	87
6.2.11. Restore Factory Default Settings.....	67	7.3.7. Lock the Front Panel Buttons	77	7.5.11. Lock an Input Port.....	87
6.3. AV PORT SETTINGS	68	7.3.8. Disable the Default Function of the Front Panel Buttons.....	77	7.5.12. Unlock an Input Port.....	87
6.3.1. Switch an Input to the Output.....	68	7.3.9. Dark Mode.....	77	7.5.13. Mute Audio Output	88
6.3.2. Mute Output.....	68	7.3.10. Dark Mode Delay	77	7.5.14. Unmute Audio Output.....	88
6.3.3. Unmute Output	68	7.4. VIDEO PORT SETTINGS	78	7.5.15. Lock Output	88
6.3.4. Lock Output.....	68	7.4.1. Query the Status of Source Ports.....	78	7.5.16. Unlock Output.....	88
6.3.5. Unlock Output	68	7.4.2. Query the Status of Destination Port	79	7.6. ANALOG AUDIO INPUT LEVEL SETTINGS	88
6.3.6. View Connection State on the Output.....	69	7.4.3. Query the Video Crosspoint Setting	79	7.6.1. Volume	88

Table of Contents

7.6.2. Balance.....	88	7.11.10. Using Hexadecimal Codes.....	95	11. APPENDIX	115
7.7. NETWORK CONFIGURATION	89	7.11.11. Sending Pronto Hex Codes in Little-endian Format via IR Port.....	96	11.1. SPECIFICATION	115
7.7.1. Query the DHCP State.....	89	7.11.12. Sending Pronto Hex Codes in Big-endian Format via IR Port.....	96	11.2. FACTORY DEFAULT SETTINGS.....	117
7.7.2. Change the DHCP State.....	89	7.12. SENDING CEC COMMANDS.....	97	11.3. CONTENT OF BACKUP FILE.....	117
7.7.3. Query the IP Address.....	89	7.12.1. Sending an OSD String.....	97	11.4. CABLE WIRING GUIDE	118
7.7.4. Change the IP Address (Static).....	89	7.12.2. Sending a CEC Command in Text Format.....	97	11.4.1. Cable Wiring Guide for Serial Data Transmission	118
7.7.5. Query the Subnet Mask.....	89	7.12.3. Sending a CEC Command in Hexadecimal Format.....	97	11.4.2. Audio Cable Wiring Guide	118
7.7.6. Change the Subnet Mask (Static).....	89	7.13. GPIO PORT CONFIGURATION.....	98	11.5. MECHANICAL DRAWINGS	119
7.7.7. Query the Gateway Address	89	7.13.1. Set the Direction of a GPIO Pin.....	98	11.5.1. UMX-TPS-TX100 series.....	119
7.7.8. Change the Gateway Address (Static).....	90	7.13.2. Set the Output Level of a GPIO Pin.....	98	11.5.2. WP-UMX-TPS-TX100 series.....	120
7.8. RS-232 PORT CONFIGURATION	90	7.13.3. Toggle the Level of a GPIO Pin	98	11.5.3. FP-UMX-TPS-TX100 series	120
7.8.1. Protocol Setting.....	90	7.14. EDID MANAGEMENT.....	98	11.6. PORT NUMBERING.....	121
7.8.2. BAUD Rate Setting.....	90	7.14.1. Query the Emulated EDIDs.....	98	11.6.1. WP-UMX-TPS-TX120-US	121
7.8.3. Databits Setting.....	90	7.14.2. Query the Validity of a Dynamic EDID	99	11.6.2. WP-UMX-TPS-TX130-US / WP-UMX-TPS-TX130-Plus-US.....	121
7.8.4. Stopbits Setting	91	7.14.3. Query the Preferred Resolution of an User EDID	99	11.6.3. UMX-TPS-TX120.....	121
7.8.5. Parity Setting.....	91	7.14.4. Emulating an EDID to an Input Port.....	99	11.6.4. UMX-TPS-TX130.....	121
7.8.6. RS-232 Operation Mode.....	91	7.14.5. Emulating an EDID to All Input Ports.....	99	11.6.5. UMX-TPS-TX140 / UMX-TPS-TX140-Plus.....	122
7.8.7. Command Injection Enable.....	91	7.14.6. Copy an EDID to User Memory	99	11.6.6. FP-UMX-TPS-TX120	122
7.9. RS-232 RECOGNIZER	92	7.14.7. Deleting an EDID from User Memory	99	11.6.7. FP-UMX-TPS-TX130	122
7.9.1. Enable the Recognizer.....	92	7.14.8. Resetting the Emulated EDIDs.....	99	11.7. MAXIMUM EXTENSION DISTANCES.....	122
7.9.2. Set the Delimiter Hex.....	92	7.15. LW3 COMMANDS - QUICK SUMMARY	100	11.8. FACTORY EDID LIST	123
7.9.3. Set the Timeout	92	8. FIRMWARE UPGRADE	104	11.9. RELEASE NOTES OF THE FIRMWARE PACKAGES	124
7.9.4. Query the Last Recognized Serial Message in String Format	92	8.1. ABOUT THE FIRMWARE PACKAGE (LFP2 FILE).....	104	11.10. HASHTAG KEYWORD LIST	126
7.9.5. Query the Last Recognized Serial Message in Hex Format.....	92	8.2. SHORT INSTRUCTIONS.....	104	11.11. FURTHER INFORMATION.....	127
7.9.6. Query the Last Recognized Serial Message in Hash Format	92	8.3. INSTALLATION OF LDU2	104		
7.9.7. Clear the Stored Last Recognized Serial Message	93	8.4. DETAILED INSTRUCTIONS.....	104		
7.9.8. Query the Last Recognized Serial Message in String Format	93	8.4.1. Establish Connection	104		
7.9.9. Query the Last Recognized Serial Message in Hex Format.....	93	8.4.2. Start the LDU2 Application and Follow the Steps	104		
7.9.10. Query the Last Recognized Serial Message in Hash Format	93	8.5. KEEPING THE CONFIGURATION SETTINGS	107		
7.9.11. Set the Active Timeout.....	93	8.6. REMOTE FIRMWARE UPGRADE OF CONNECTED LIGHTWARE DEVICES	108		
7.10. INFRARED PORT CONFIGURATION	93	9. TROUBLESHOOTING.....	109		
7.10.1. Enable Command Injection Mode.....	93	9.1. USE CASES.....	109		
7.10.2. Enable/Disable Output Signal Modulation.....	93	9.2. HOW TO SPEED UP THE TROUBLESHOOTING PROCESS	111		
7.11. SENDING MESSAGE VIA THE COMMUNICATION PORTS	94	10. TECHNOLOGIES.....	112		
7.11.1. Sending a TCP Message (ASCII-format) via TCP Port.....	94	10.1. EDID MANAGEMENT.....	112		
7.11.2. Sending a TCP Text (ASCII-format) via TCP Port.....	94	10.1.1. Understanding the EDID.....	112		
7.11.3. Sending a TCP Binary Message (HEX-format) via TCP Port	94	10.1.2. Advanced EDID Management.....	112		
7.11.4. Sending UDP Message (ASCII-format) via TCP Port	94	10.2. HDCP MANAGEMENT	113		
7.11.5. Sending a TCP Text (ASCII-format) via TCP Port.....	95	10.2.1. Protected and Unprotected Content	113		
7.11.6. Sending a UDP Binary Message (HEX-format) via TCP Port.....	95	10.2.2. Disable Unnecessary Encryption.....	113		
7.11.7. Sending a Message (ASCII-format) via Serial Port	95	10.3. PIXEL ACCURATE RECLOCKING	114		
7.11.8. Sending a Text (ASCII-format) via Serial Port.....	95				
7.11.9. Sending a Binary Message (HEX-format) via Serial Port.....	95				

1

Introduction

Thank you for choosing Lightware's UMX-TPS-TX100 series device. In the first chapter we would like to introduce the device highlighting the most important features in the below listed sections:

- ▶ [DESCRIPTION](#)
- ▶ [COMPATIBLE DEVICES](#)
- ▶ [MODEL DENOMINATION](#)
- ▶ [BOX CONTENTS](#)
- ▶ [FEATURES](#)
- ▶ [MODEL COMPARISON](#)
- ▶ [TYPICAL APPLICATION](#)

1.1. Description

This transmitter was designed to extend digital and analog video signals (e.g. VGA, DVI 1.0, HDMI 1.4 and DP 1.1) and audio signals (analog stereo audio from local inputs or embedded 7.1 HBR audio). Video signals with HDCP encryption are also supported. Analog signals (both audio and video) are converted to digital format and the audio signals can be de-embedded from the video. Thus, many combinations of the audio/video signals are available to transmit.

Using the factory, custom or transparent EDID emulation the user can fix and lock EDID data on each input connector. Advanced EDID Management forces the required resolution from any video source and fixes the output format conforming to the system requirements. The unit offers bi-directional and transparent IR, RS-232 and Ethernet transmission. Furthermore, the IR and RS-232 connection support command injection, allowing it to send any IR or RS-232 control command directly from the LAN connection. The built-in USB port offers KVM extension in UMX-TPS-TX140K model.

Remote powering (Power over Ethernet) is available through a single CAT cable, but local power supply can also be used. UMX-TPS transmitter can be mounted on a rack shelf or used standalone while the WP-UMX-TPS and FP-UMX-TPS transmitters designed to place into a wall, furniture, or a floorbox. The transmitters are compatible with both the HDBaseT™ extenders and matrix switchers.

1.2. Compatible Devices

The transmitter is compatible with other Lightware TPS receivers, matrix TPS and TPS2 boards, 25G TPS2 boards, as well as third-party HDBaseT extenders, displays, but not compatible with the phased out TPS-90 extenders.



The transmitter is compatible with any third-party HDBaseT™ device.

HDBaseT™ and the HDBaseT Alliance logo are trademarks of the HDBaseT Alliance.

USB Compatibility

The USB KVM extension is available between UMX-TPS-TX140K and HDMI-TPS-RX220AK models.

1.3. Model Denomination

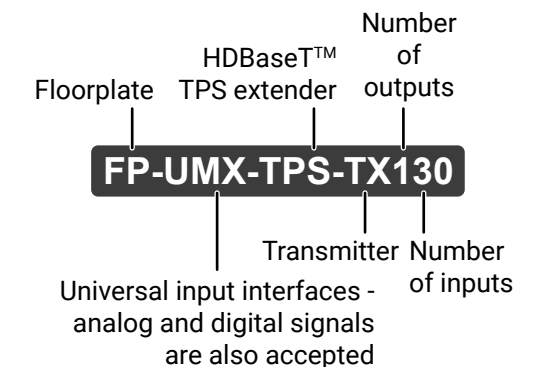
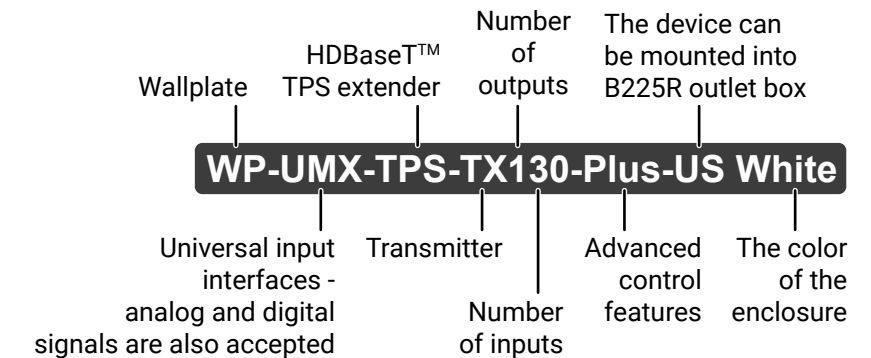
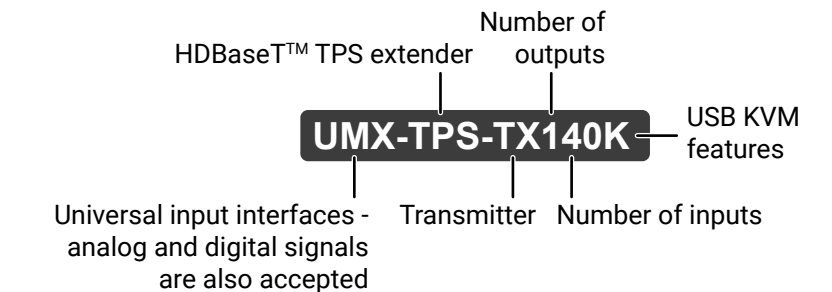
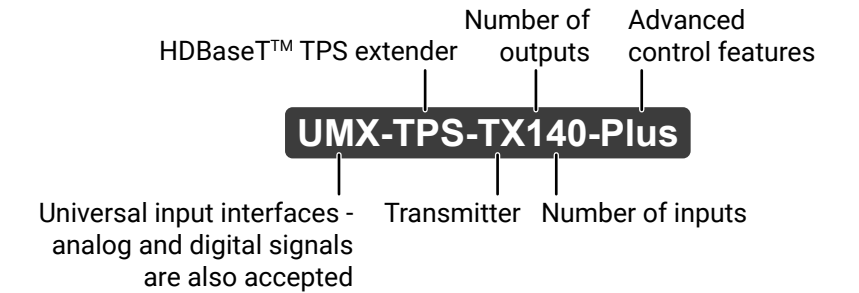

1.4. Box Contents

1.4.1. UMX-TPS-TX100 series

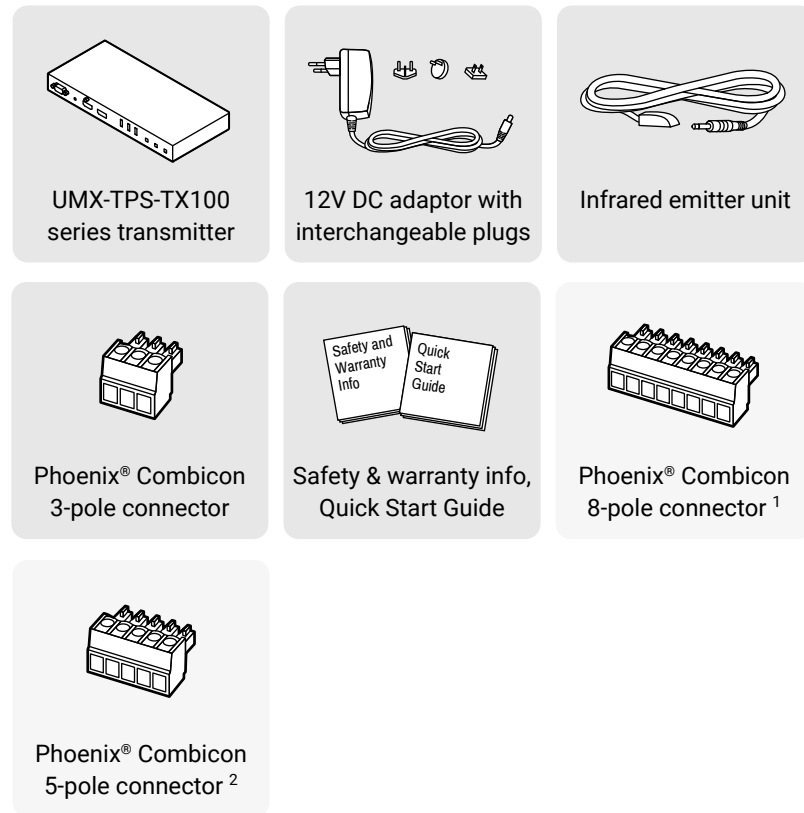

¹ For UMX-TPS-TX130, UMX-TPS-TX140, and UMX-TPS-TX140K, UMX-TPS-TX140-Plus models.

² For UMX-TPS-TX140, UMX-TPS-TX140K and UMX-TPS-TX140-Plus models.

1.4.2. WP-UMX-TPS-TX100 series

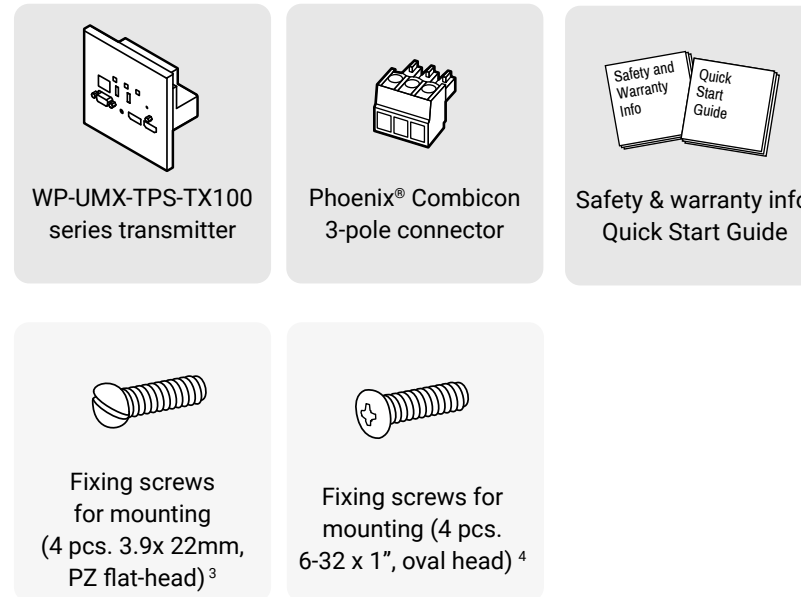

³ For white models of WP-UMX-TPS-100 series.

⁴ For black models of WP-UMX-TPS-100 series.

Optional Accessories

The following accessories can be purchased separately, please contact sales@lightware.com for the details.

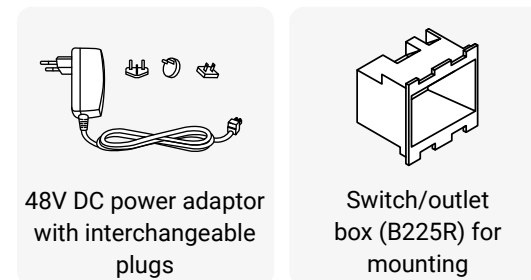

1.4.3. FP-UMX-TPS-TX100 series



Optional Accessories

The following accessories can be purchased separately, please contact sales@lightware.com for the details.

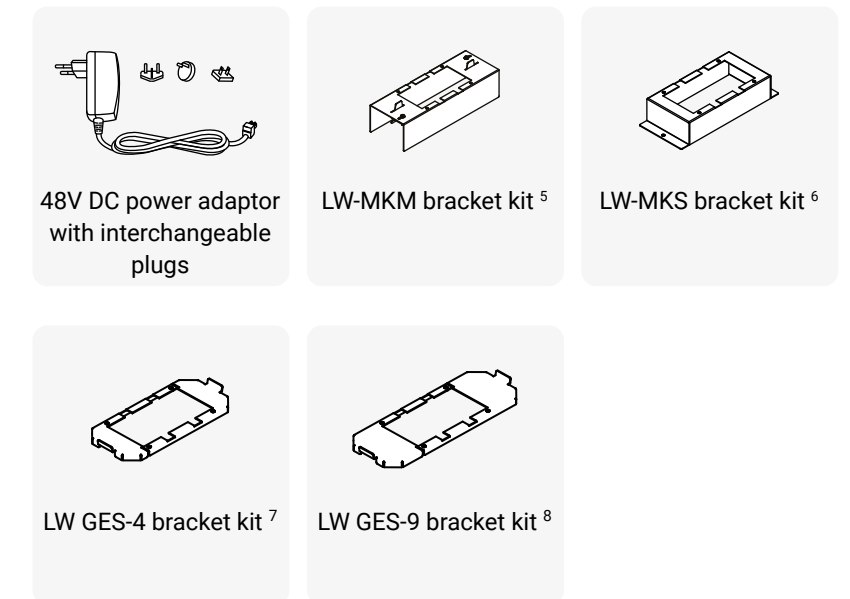

⁵ For MKM mounting option only. See the details in the [MKM Mounting Option](#) section.

⁶ For MKS mounting option only. See the details in the [MKS Mounting Option](#) section.

⁷ For GES4 mounting option only. See the details in the [GES Mounting Option](#) section.

⁸ For GES9 mounting option only. See the details in the [GES Mounting Option](#) section.

1.5. Features



3D and 4K Support

High bandwidth allows extension of resolutions up to 4K and even 3D sources and displays are supported.



Signal Transmission up to 170 m

Video and audio signal transmission (HDMI, Ethernet, RS-232, and Infra-Red) over a single CAT5e...CAT7e cable.

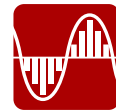

Analog Audio and Video A/D Conversion

Analog audio and video signals are converted to digital before being sent to the output.



Deep Color Support and Conversion

It is possible to transmit the highest quality 36-bit video streams for perfect color reproduction.



Pixel Accurate Reclocking

Each output has a clean, jitter free signal, eliminating signal instability and distortion caused by long cables or connector reflections.



HDCP-compliant

The receiver fulfills the HDCP standard. HDCP capability on the digital video inputs can be disabled when non-protected content is extended.



Built-in Event Manager

The Event Manager tool takes care of all the necessary control in a smaller configuration by performing predefined actions in response to device status changes. Hence, in a less complex environment, there is no need to invest in additional control solutions, which makes the receiver the best choice for numerous applications.



Autoselect Function for Video Inputs

The Autoselect feature can sense the port status on the video input ports and select automatically one of them. Priority number can be set for each input port and the feature allows to set various modes for the automatic input selection (First detect, Last detect, Priority mode).

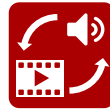

Breakaway Audio/Video Switching

Breakaway audio/video switching allows for switching audio and video separately by de-embedding and embedding audio from/into HDMI signals. For instance, audio can be de-embedded from the incoming HDMI stream, then at output a different audio can be embedded into the video signal from a different source, or audio can be routed to a separate output port.



Remote Power

The transmitters are PoE-compatible and can be powered locally by the supplied power adaptor, or remotely via the TPS connection (through the CATx cable) with a compatible power source equipment.



TPS Cable Diagnostic Tool

The TPS Cable Diagnostics Tool within the LDC software will help you identify potential twisted pair cable issues in your TPS-capable (HDBaseT compliant) system. It provides a real-time overview of the estimated cable lengths and the quality of the link.



IR

Infrared (IR) is a wireless technology used for device communication over short ranges. IR communication has major limitations because it requires line-of-sight, has a short transmission range and is unable to penetrate walls. Infrared is commonly used for remote control based applications. Third-party control systems may send IR control commands to endpoints turning them on and off or switching their inputs. IR capable extenders can carry the IR signal via CAT cable to greater distances along with other data.



Bi-directional RS-232 Pass-through

AV systems can also contain serial port controllers and controlled devices. Serial port pass-through supports any unit that works with standard RS-232.



GPIO Control Port

7 GPIO pins operating at TTL digital signal levels and can be controlled with both LW2 and LW3 commands.

DIFFERENCE: The UMX-TPS-TX130, UMX-TPS-TX140, UMX-TPS-TX140K, and UMX-TPS-TX140-Plus models supplied with GPIO Control port.

Advanced Control Features

DIFFERENCE: WP-UMX-TPS-TX130-Plus-US and UMX-TPS-TX140-Plus and UMX-TPS-TX140K models have advanced control features.



Consumer Electronic Control

Supports transmitting standard CEC commands in order to remote control the source or sink device.



Infra Message Sending

Infrared (IR) is a wireless technology used for device communication over short ranges. Third party control systems may send IR control commands to endpoints turning them on and off or switching their inputs.



RS-232 Recognizer

Support recognizing incoming RS-232 messages to integrate with 3rd party devices like VC codec.

USB KVM Feature *#new*

DIFFERENCE: Only the UMX-TPS-TX140K model is supplied with USB port.



















USB Extension

KVM extension for USB HID (Human Interface Devices, e.g. keyboard, mouse, presenter).

1.6. Model Comparison

The available models have different features depending on their design. The following table contains the most important differences between the models:

		Video ports				Audio ports		Interface ports					Advanced control features				
		HDMI input 	VGA input 	DVI-I input 	DP input 	Jack 3.5 input 	Phoenix input 	Ethernet 	Infra I/O connectors 	Infra input sensor 	RS-232 	GPIO 	mini USB-B 	No. of Events in Event Manager 	Infra message sending 	CEC message sending 	RS-232 recognizer 
Standalone models	UMX-TPS-TX120	✓	✓	-	-	✓	-	✓	✓	-	✓	-	-	20	-	-	-
	UMX-TPS-TX130	✓	✓	✓	-	✓	-	✓	✓	-	✓	✓	-	20	-	-	-
	UMX-TPS-TX140	✓	✓	✓	✓	✓	✓	✓	✓	-	✓	✓	-	20	-	-	-
	UMX-TPS-TX140-Plus	✓	✓	✓	✓	✓	✓	✓	✓	-	✓	✓	-	100	✓	✓	✓
	UMX-TPS-TX140K <i>#new</i>	✓	✓	✓	✓	✓	✓	✓	✓	-	✓	✓	✓	100	✓	✓	✓
Wall plate models	WP-UMX-TPS-TX120-US Black	✓	✓	-	-	✓	-	✓	-	✓	✓	-	-	20	-	-	-
	WP-UMX-TPS-TX120-US White	✓	✓	-	-	✓	-	✓	-	✓	✓	-	-	20	-	-	-
	WP-UMX-TPS-TX130-US Black	✓	✓	-	✓	✓	-	✓	-	✓	✓	-	-	20	-	-	-
	WP-UMX-TPS-TX130-US White	✓	✓	-	✓	✓	-	✓	-	✓	✓	-	-	20	-	-	-
	WP-UMX-TPS-TX130-Plus-US Black	✓	✓	-	✓	✓	-	✓	-	✓	✓	-	-	100	✓	✓	✓
	WP-UMX-TPS-TX130-Plus-US White	✓	✓	-	✓	✓	-	✓	-	✓	✓	-	-	100	✓	✓	✓
Floor plate models	FP-UMX-TPS-TX120	✓	✓	-	-	✓	-	✓	-	✓	✓	-	-	20	-	-	-
	FP-UMX-TPS-TX130	✓	✓	-	✓	✓	-	✓	-	✓	✓	-	-	20	-	-	-

1.7. Typical Application

Standalone Application Diagram - UMX-TPS-TX140

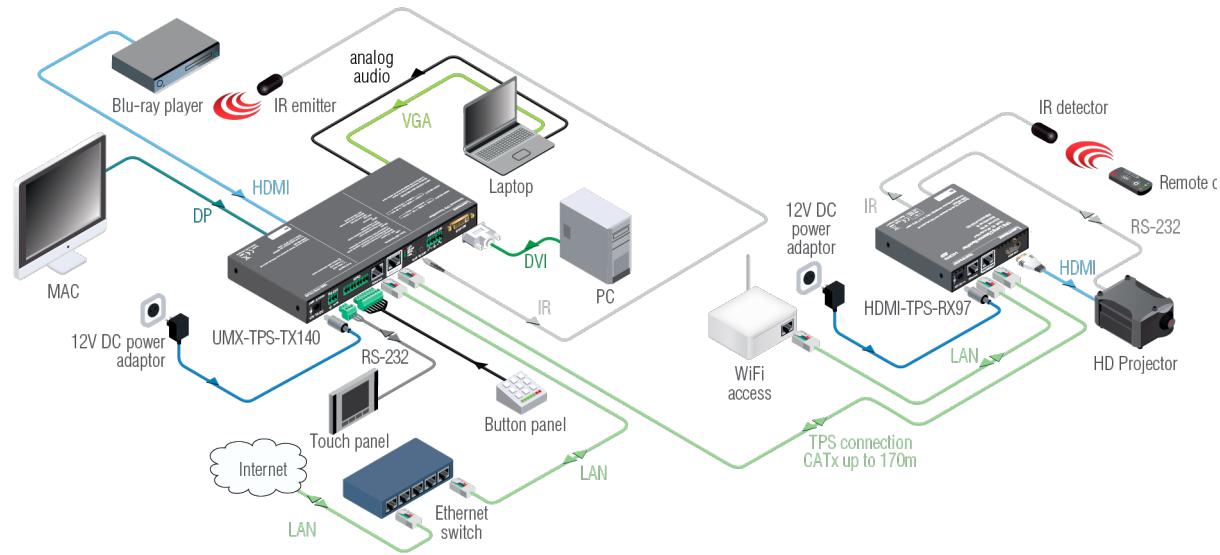

Integrated System Diagram - UMX-TPS-TX140

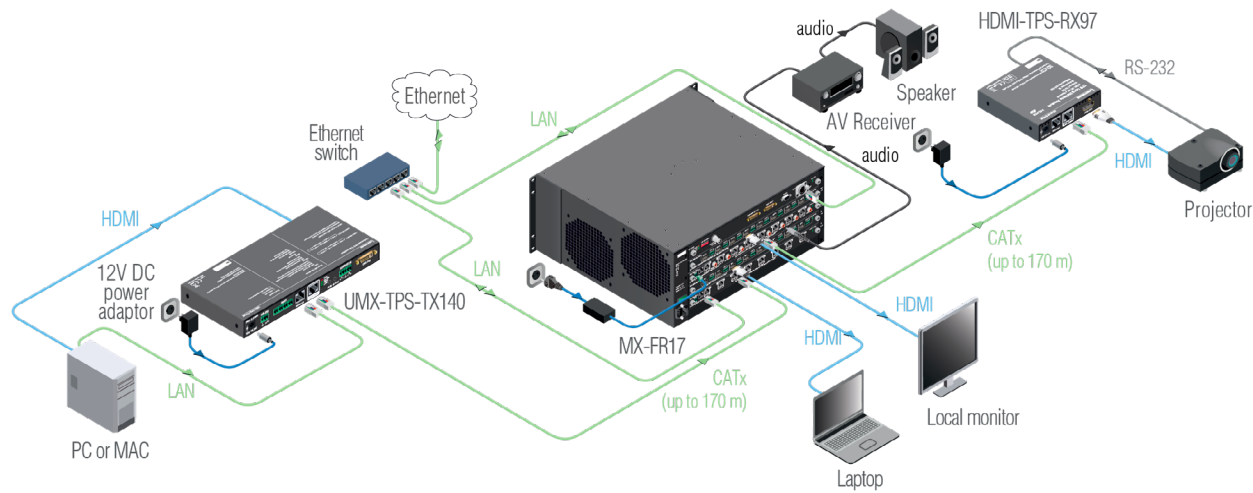

Standalone Application Diagram - UMX-TPS-TX140K #new

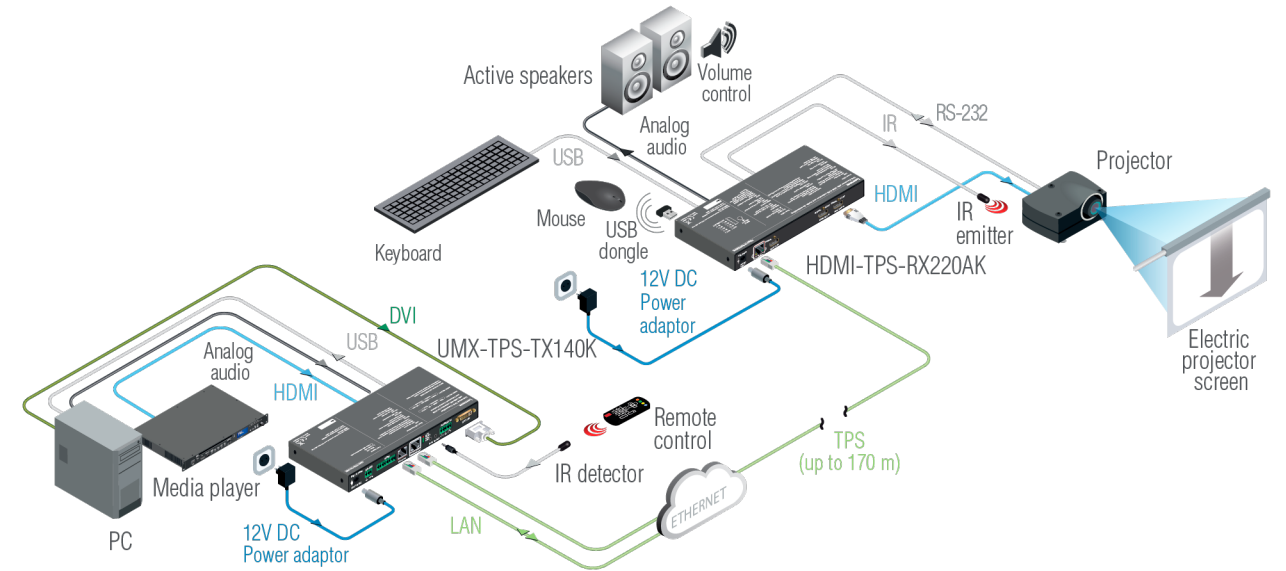

Standalone Application Diagram - WP-UMX-TPS-TX130-US

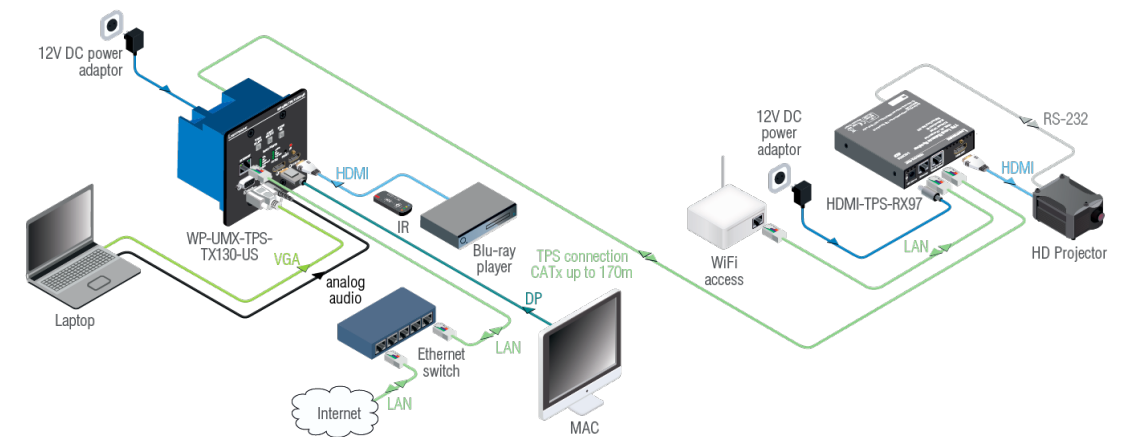

2

Installation

The chapter is about the installation of the device and connecting to other appliances, presenting also the mounting options and further assembly steps

- ▶ [MOUNTING OPTIONS - STANDALONE TRANSMITTERS](#)
- ▶ [MOUNTING OPTIONS - FLOOR PLATES](#)
- ▶ [MOUNTING OPTIONS - WALL PLATES](#)
- ▶ [CONNECTING STEPS](#)

2.1. Mounting Options - Standalone Transmitters

To mount the transmitter Lightware supplies optional accessories for different usage. There are two kinds of mounting kits with similar fixing method. The device has two mounting holes with inner thread on the bottom side; see the bottom view in the [Mechanical Drawings](#) section. Fasten the device by the screws enclosed to the accessory:

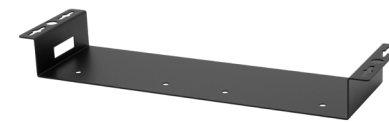

Under-desk double mounting kit



1U high rack shelf

The Under-desk double mounting kit makes easy to mount a single device on any flat surface, e.g. furniture. 1U high rack shelf provides mounting holes for fastening two half-rack or four quarter-rack sized units. Pocket-sized devices can also be fastened on the shelf. To order mounting accessories please contact sales@lightware.com.

WARNING! Always use the supplied screws. Using different (e.g. longer) ones may cause damage to the device.

INFO: The transmitter is half-rack sized.

2.1.1. Under-desk Double Mounting Kit

The UD-kit double makes it easy to mount a single transmitter on any flat surface (e.g. furniture).



- ▶ **INFO:** The chipboard screws are not supplied with the mounting kit.
- #### 2.1.2. 1U High Rack Shelf

Allows rack mounting for half-rack, quarter-rack and pocket sized units.

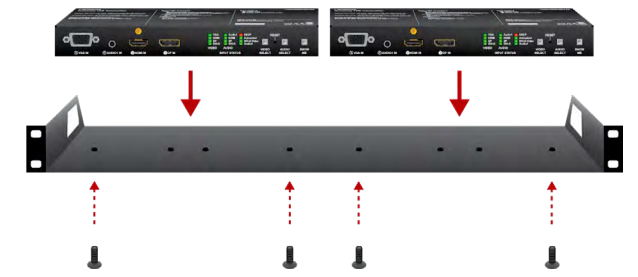

1U high rack shelf provides mounting holes for fastening two half-rack or four quarter-rack sized units. Pocket sized devices can also be fastened on the self.



Standard rack installation

ATTENTION! Always use all the four screws for fixing the rack shelf ears to the rack rail. Choose properly sized screws for mounting. Keep minimum two threads left after the nut screw.

2.2. Mounting Options - Floor Plates

2.2.1. MKM Mounting Option

Floor Box Compatibility Table

Compatible Lightware mounting bracket kit	Compatible Floor Boxes			
	Product family	Part number	Sample picture	Comment
FP-UMX-TPS MKM Kit	MK Cablelink Plus Modular Floorboxes	CRMB265-3GRY		The transmitter unit can be mounted to the place of a compartment (a service power module or an unserviced data module).
		CRMB265-3GRYL		
		CRMB340-4GRY		
		CRMB340-4GRYL		
	Ackermann Cablelink Modular Floorboxes	CRMB265-3GRY		
		CRMB265-3GRYL		
		CRMB340-4GRY		
		CRMB340-4GRYL		

Mounting Steps - FP-UMX-TPS MKM Kit

The FP-UMX-TPS MKM kit can be ordered separately, please contact sales@lightware.com.

Dimensions of the Bracket

The following drawing and table represents the dimensions of the Lightware brackets assembled with the transmitter unit. The values are in mm.

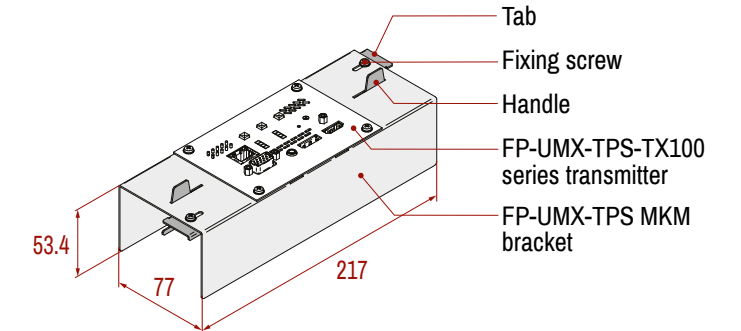

Dimensions and layout of the MKM bracket

Step 1. Assembling of the bracket: insert both handle tab parts to the bracket and fix them with the two supplied **M3x6 PH fixing screws**. **Do not tighten well** the screws, the tabs must stay movable.

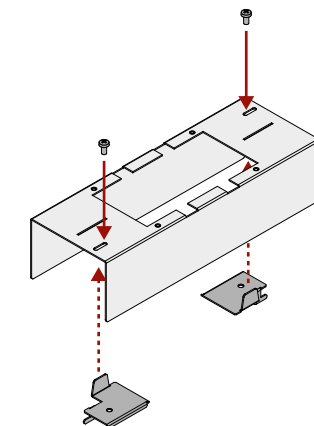

Step 2. Insert the bracket into the frame.

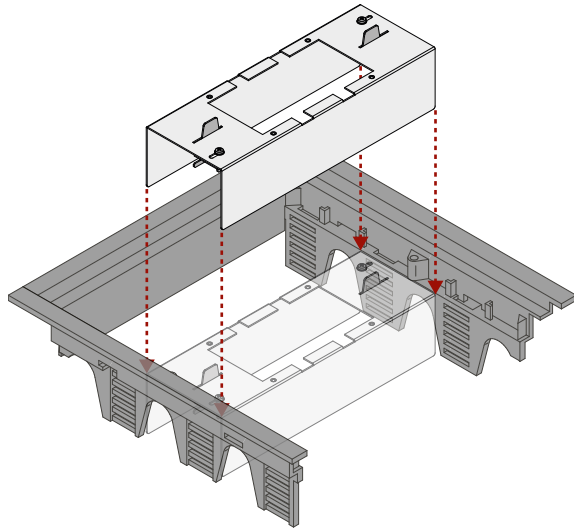

Step 3. Move the **handles** towards the frame. Align the tab on the assembly with the **top slot** in the frame.

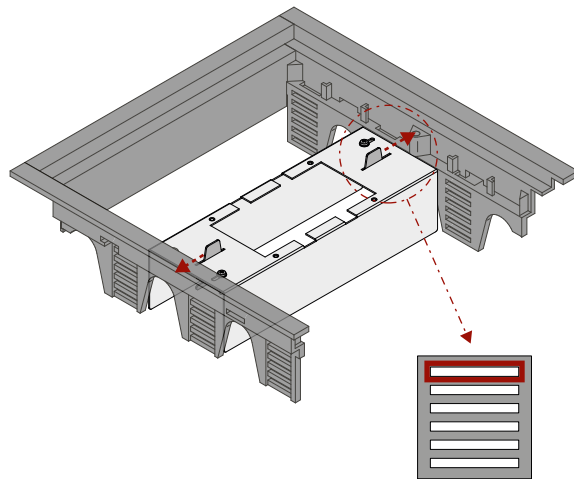

Step 4. Fasten the **fixing screws** to fix the device into the floor box frame.

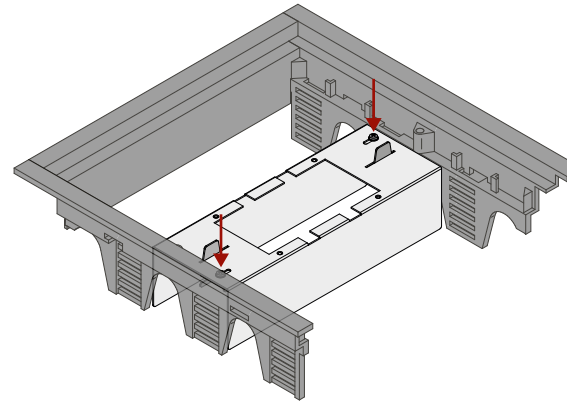

Step 5. Place the transmitter to the bracket.

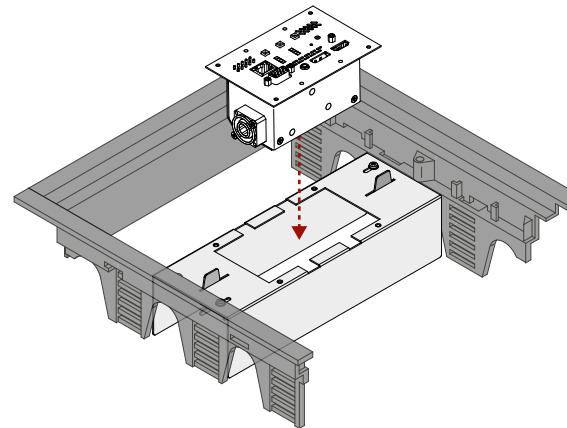

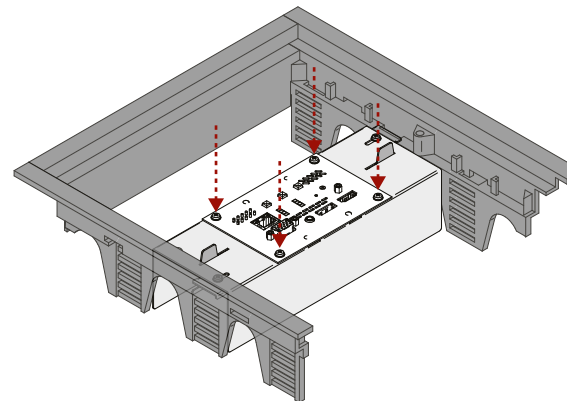

Step 6. Fasten the all four **M3x6 PH fixing screws** to fix the device to the bracket.

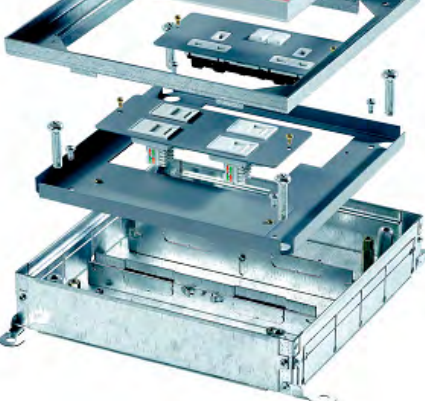

2.2.2. MKS Mounting Option

Floor Box Compatibility Table

Compatible Lightware mounting bracket kit	Compatible Service Outlet Boxes			
	Product family	Part number	Sample picture	Comment
FP-UMX-TPS MKS Kit	MK Cablelink Plus Screed System	CUB100UK-1		
		CUB200UK-2		
		CUB265UK-3		
		CUB340UK-4		
		CUB100XUK-1		
		CUB200XUK-2		
		CUB265XUK-3		
		CUB340XUK-4		
	MK Cablelink Single Pan Boxes	CRB100UK-70-1GRY		
		CRB265UK-70-3GRY		
		CRB340UK-70-4GRY		
		CRB100UK-1GRY		
		CRB265UK-3GRY		
		CRB340UK-4GRY		
	MK Cablelink Onix Plus Screeded Floor System	NXB200X-2		
		NXB265X-2		
		NXB265X-3		
		NXB340X-3		
		NXB340X-4		
		NXB340X-4		

The transmitter unit can be mounted to the place of a compartment (a serviced/unserved power plate or an unserved data plate).

Mounting Steps - FP-UMX-TPS MKS Kit

The FP-UMX-TPS MKS kit can be ordered separately, please contact sales@lightware.com.

Dimensions of the Bracket

The following drawing and table represents the dimensions of the Lightware brackets assembled with the transmitter unit. The values are in mm.

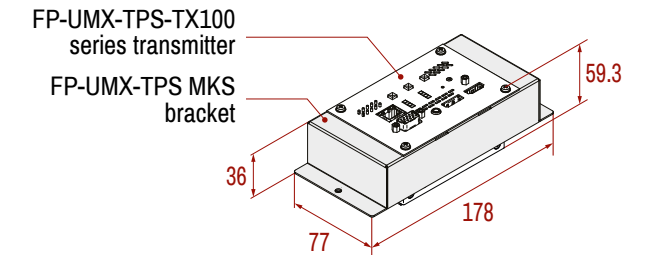

Dimensions and layout of the MKS bracket

Step 1. Place the MKS bracket to the floor box so that the screw holes are able to fit. Fasten the bracket with both supplied **DIN 7981 3,5x19 PZ2 self tapping screws**.

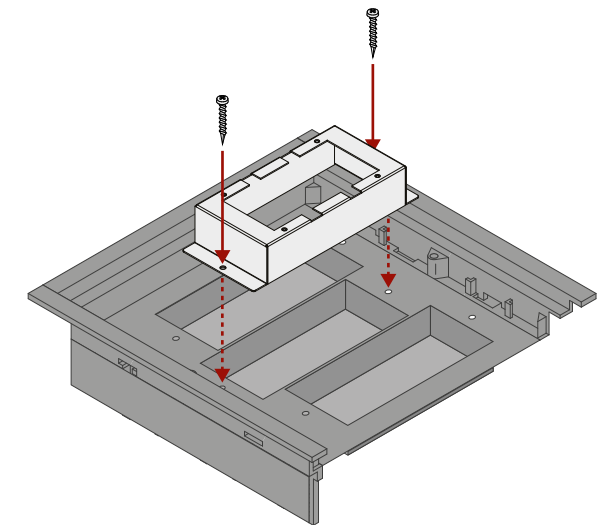

Step 2. Place the transmitter to the bracket.

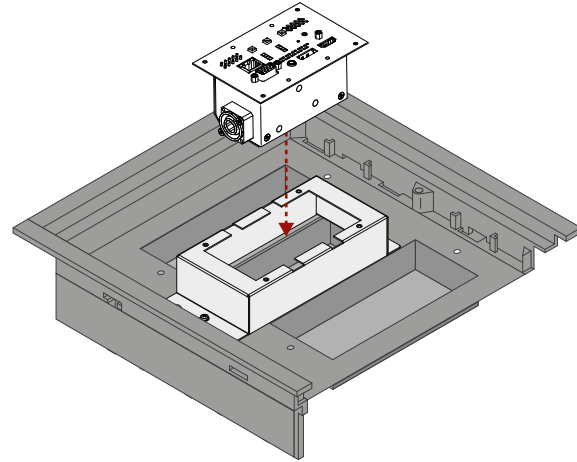

Step 3. Fasten the all four M3x6 PH fixing screws to fix the device to the bracket.

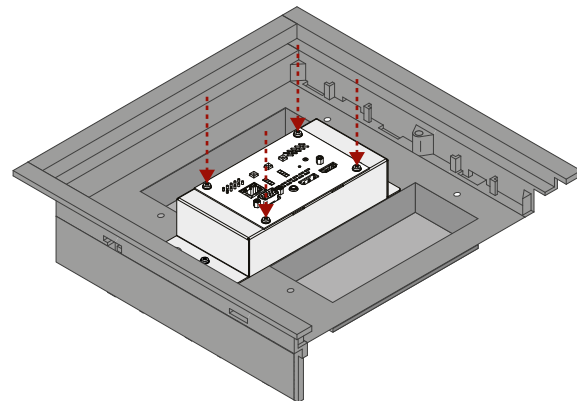



2.2.3. GES Mounting Option

Floor Box Compatibility Tables

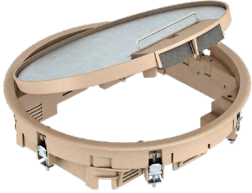

Compatible Service Outlets (Rectangular)

Compatible Lightware mounting bracket	Compatible Service Outlets (Rectangular)				
	Product family	Type	Part number	Sample picture	Comment
FP-UMX-TPS GES4 Kit	OBO Bettermann GES4, rectangular	GES4 U 7011	7405 19 6		The transmitter unit assembled with the supplied brackets can be mounted to the place of an UT3 module.
		GES4 U 9011	7405 20 0		
		GES4 U 1019	7405 20 4		
		GES4-2U10T 7011	7405 14 5		
		GES4-2U10T 9011	7405 14 6		
		GES4-2U10T 1019	7405 14 7		
		GES4M-2 10U	7405 19 1		
	OBO Bettermann GES6, rectangular	GES6 U 7011	7405 30 8		
		GES6 U 9011	7405 31 2		
		GES6 U 1019	7405 31 6		
		GES6-2U10T 7011	7405 32 1		
		GES6-2U10T 9011	7405 32 2		
		GES6-2U10T 1019	7405 32 3		
		GES6M-2 10U	7405 29 9		
FP-UMX-TPS GES9 Kit	OBO Bettermann GES9, rectangular	GES9-3B U 7011	7405 07 7		
		GES9-3B U 9011	7405 07 9		
		GES9-3B U 1019	7405 08 1		
		GES9-3S U 7011	7405 08 3		
		GES9-3S U 9011	7405 08 5		
		GES9-3S U 1019	7405 08 7		
		GES9M-2 10U	7405 37 1		

Compatible Service Outlets (Round)

Compatible Lightware mounting bracket	Compatible Service Outlets (Round)				
	Product family	Type	Part number	Sample picture	Comment
FP-UMX-TPS GES4 Kit	OBO Bettermann GESR4, round	GESR4 U 7011	7405 43 6		The transmitter unit assembled with the supplied brackets can be mounted to the place of an UT3 module.
		GESR4 U 9011	7405 44 0		
		GESR4 U 1019	7405 44 4		
	OBO Bettermann GESR7, round	GESR7 10U 7011	7405 45 2		
		GESR7 10U 9011	7405 45 6		
		GESR7 10U 1019	7405 46 0		
		GESRA7 10U	7405 54 4		
FP-UMX-TPS GES9 Kit	OBO Bettermann GESR9, round	GESR9 U 7011	7405 52 8		The transmitter unit assembled with the supplied brackets can be mounted to the place of an UT4 module.
		GESR9 U 9011	7405 53 2		
		GESR9 U 1019	7405 53 6		
		GESR9-2U12T 7011	7405 46 5		
		GESR9-2U12T 9011	7405 46 6		
		GESR9-2U12T 1019	7405 46 7		
		GESR9 SR U 7011	7405 51 2		
		GESR9 SR U 9011	7405 51 6		
		GESR9 SR U 1019	7405 52 0		
		GESRA9 10U	7405 58 0		

Compatible Device Installation Units (Floor Boxes)

Compatible Lightware mounting bracket	Compatible Device Installation Units (Floor Boxes)				
	Product family	Type	Part number	Sample picture	Comment
FP-UMX-TPS GES4 Kit	OBO Bettermann UDHOME4	UDHOME4 2V MT U	7427 24 8		The transmitter unit assembled with the supplied brackets can be mounted to the place of an MT3 module.
		UDHOME4 2M MT U	7427 25 2		
FP-UMX-TPS GES9 Kit	OBO Bettermann UDHOME9	UDHOME9 2V GB V	7427 30 0		The transmitter unit assembled with the supplied brackets can be mounted to the place of an GB3 module.
		UDHOME9 2M GB V	7427 30 4		
		UDHOME9 2V MT V	7427 30 8		The transmitter unit assembled with the supplied brackets can be mounted to the place of an MT4 module.
		UDHOME9 2M MT V	7427 31 2		

Mounting Steps - FP-UMX-TPS GES4 / GES9 Kits

The FP-UMX-TPS GES4 / GES9 kits can be ordered separately, please contact sales@lightware.com.

Dimensions of the Brackets

The following drawing and table represents the dimensions of the Lightware brackets assembled with the transmitter unit. The two types of GES bracket pairs have different dimensions. The values are in mm.

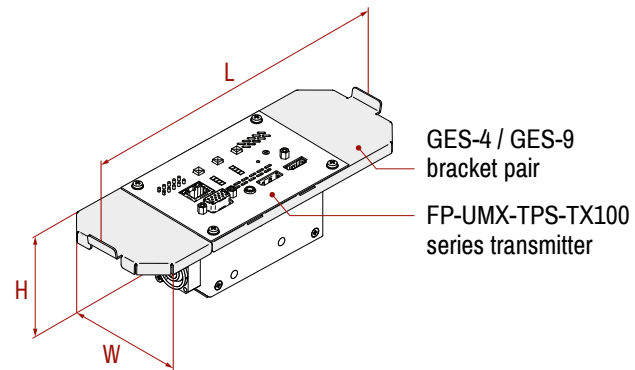

Parameter	LW GES-4	LW GES-9
H	53.4	53.4
L	174.1	216.1
W	76	76

Mounting Steps

Step 1. Place the two half of the brackets of GES4 / GES9 to the floor box. **Hook up** the upper ears of the brackets to the **top** mounting slot.

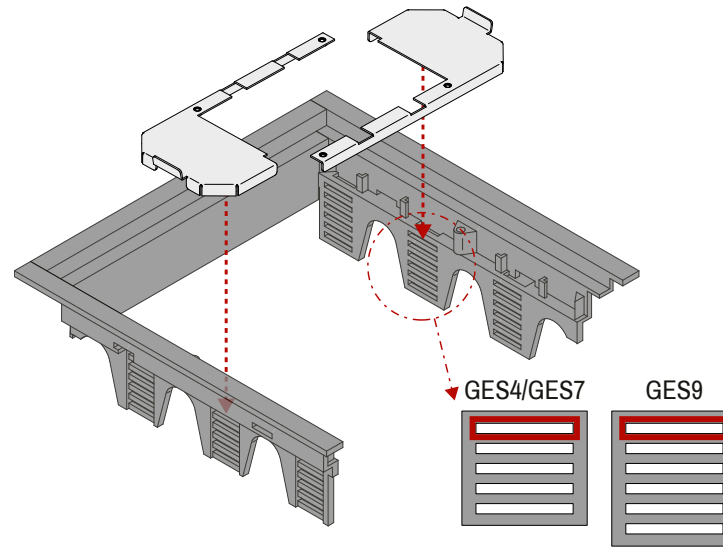

Step 2. Place the transmitter to the brackets.

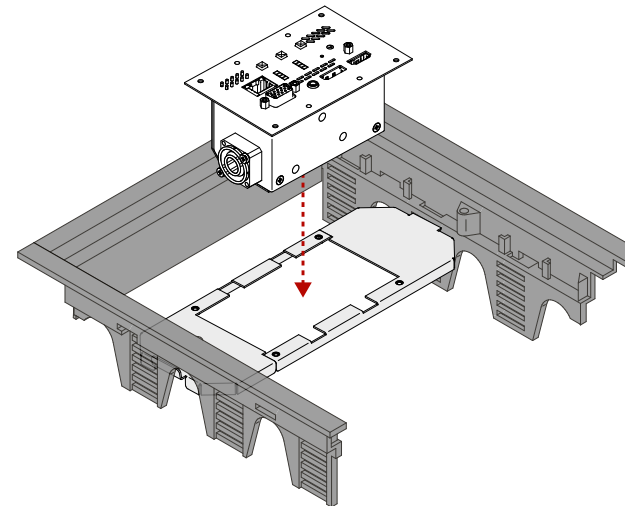

Step 3. Fasten the all four M3x6 PH fixing screws to fix the device to the brackets.

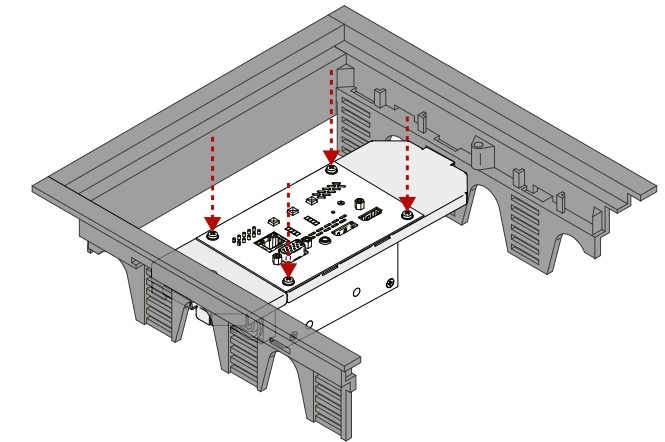

2.3. Mounting Options - Wall Plates

Switch / Outlet Box Compatibility Table

Model	Color of the front panel	Mounting		
		Type	Part number	Picture
WP-UMX-TPS-TX120-US Black	Black	Carlson B225R-UPC	7TAA040070R0000	
WP-UMX-TPS-TX130-US Black	Black			
WP-UMX-TPS-TX130-Plus-US Black	Black			
WP-UMX-TPS-TX120-US White	White			
WP-UMX-TPS-TX130-US White	White			
WP-UMX-TPS-TX130-Plus-US White	White			

Mounting Steps - WP-UMX-TPS-TX100 series

The transmitter can be easily mounted into an industrial standard switch/outlet box (B225R):

INFO: The switch/outlet box is not supplied with the mounting kit but it can be purchased separately. Please contact sales@lightware.com for the details.

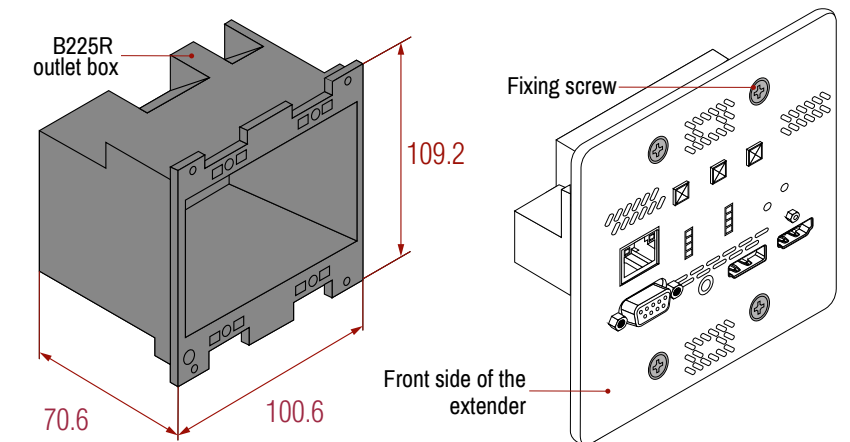

Step 4. Insert the extender into the B225R outlet box and position it to get the holes aligned.

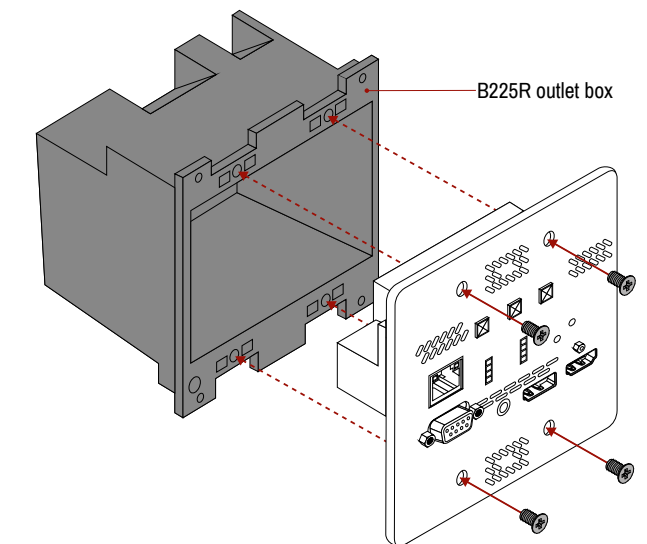

Step 5. Fasten the front side of the extender to the B225R outlet box by fitting all the screws.

2.4. Connecting Steps

2.4.1. FP/WP-UMX-TPS-TX100 series

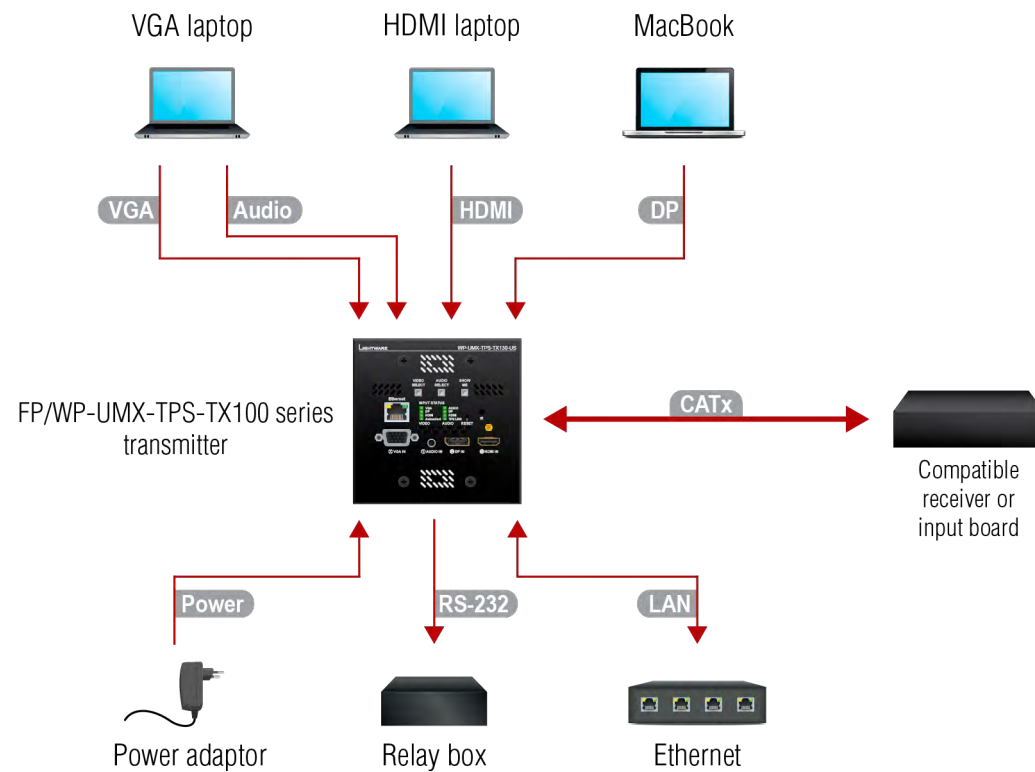

- CATx** Connect the transmitter and a compatible receiver or the matrix input board by a CATx cable via the TPS connectors.
- VGA**
HDMI
DP Connect the transmitter and the sources using the inputs and VGA / DVI-I / HDMI / DisplayPort cables.
- Audio** Optionally connect an asymmetric audio device with unbalanced audio signal (e.g. a VGA laptop) to the 2.5" TRS (jack) audio input port.
- LAN** Optionally connect the transmitter to a LAN network in order to control the device.
- RS-232** Optionally connect a controller/controlled device (e.g. relay box) to the RS-232 port.
- Power** See powering options in the next section.

2.4.2. UMX-TPS-TX100 series

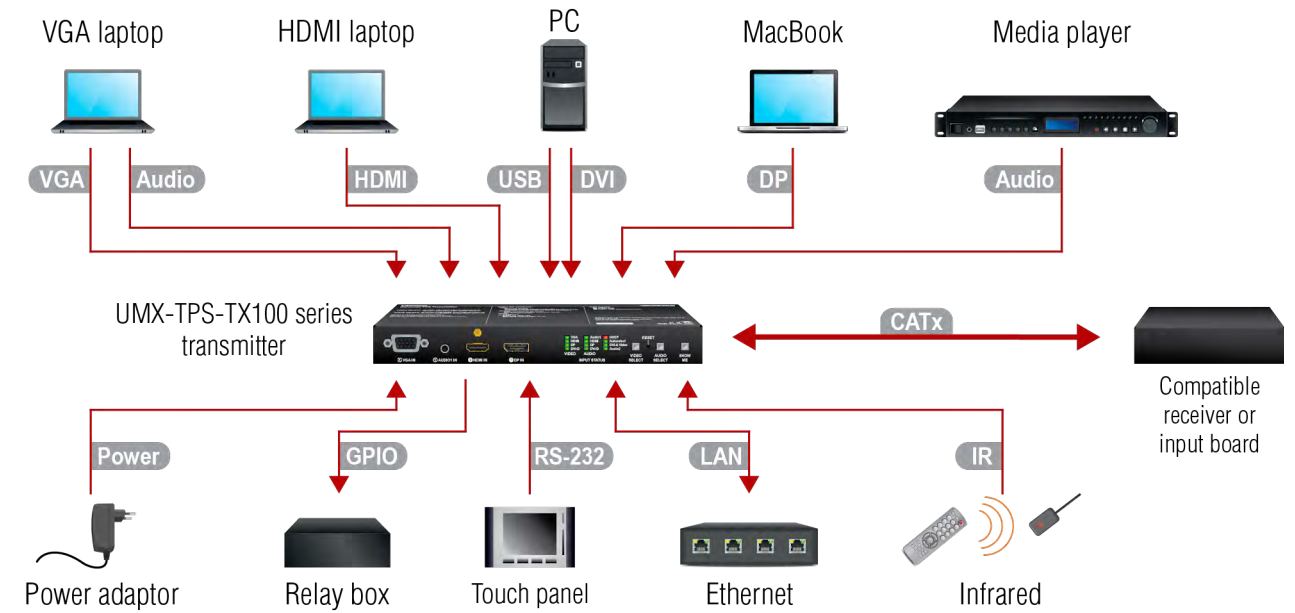

- CATx** Connect the transmitter and a compatible receiver or the matrix input board by a CATx cable via the TPS connectors.
- VGA**
DVI
HDMI
DP Connect the transmitter and the sources using the inputs and VGA / DVI-I / HDMI / DisplayPort cables.
- Audio** Optionally connect an asymmetric audio device with unbalanced audio signal (e.g. a VGA laptop) to the 2.5" TRS (jack) audio input port.
- Audio** Optionally connect a symmetric audio device with balanced audio signal (e.g. a media player) to the 5-pole Phoenix audio input port. See the wiring guide for the connector in the [Audio Cable Wiring Guide](#) section.
- USB** Only for UMX-TPS-TX140K: Optionally for USB HID extension: connect the transmitter to the computer by the USB-B cable and connect at least one USB HID device to the compatible receiver.
- IR** Optionally for Infrared control:
 - Connect the IR emitter to the IR OUT port of the device.
 - Connect the IR detector to the IR IN port of the device.
- LAN** Optionally connect the transmitter to a LAN network in order to control the device.
- RS-232** Optionally for RS-232 control: connect a controller/controlled device (e.g. touch panel) to the RS-232 port.
- GPIO** Optionally connect a controller/controlled device (e.g. relay box) to the GPIO port.
- Power** See powering options in the next section.

2.5. Powering Options

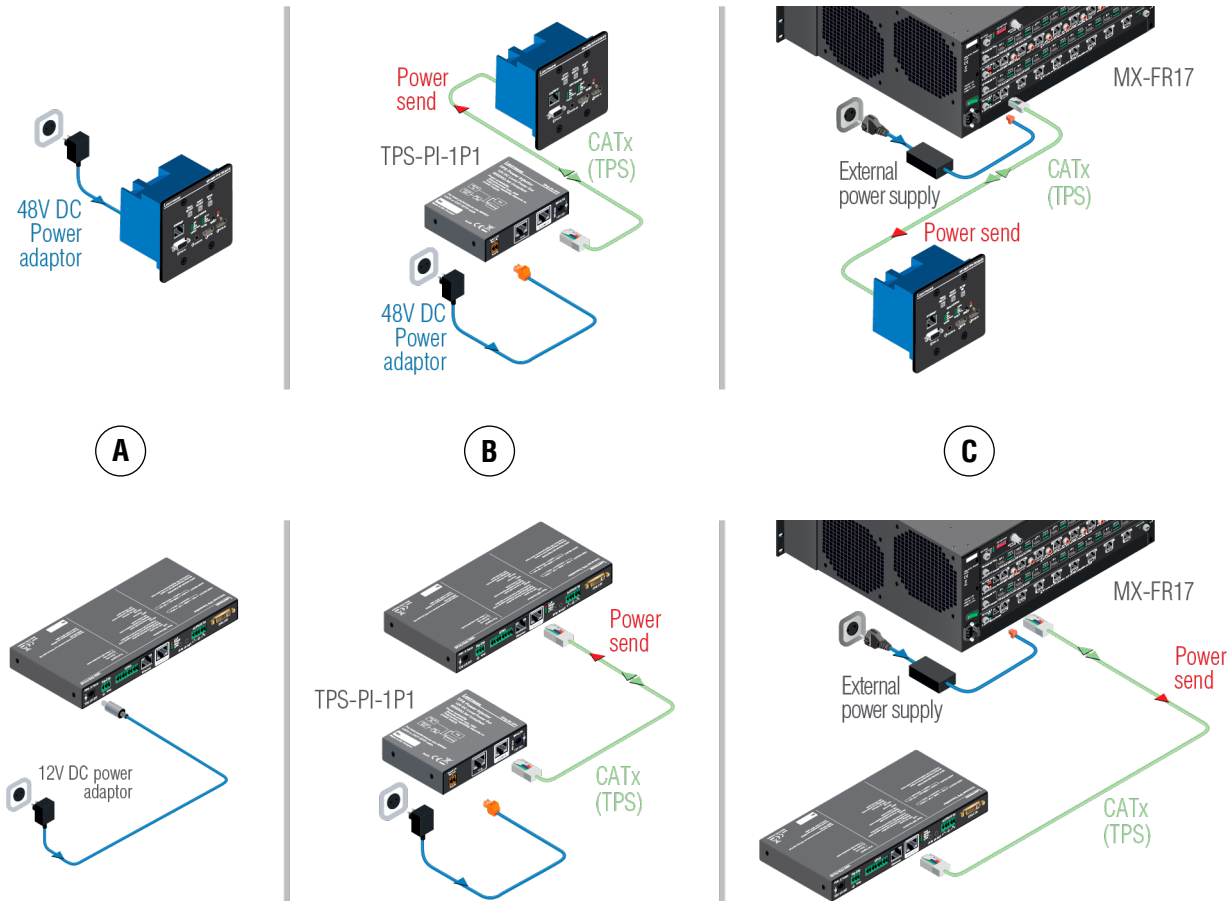

- A** **Using local PSU** - connect the power adaptor to the DC input on the transmitter first, then to the AC power socket.
- B** **Using PoE with connecting a transmitter:** connect the TPS OUT (PoE) port of the transmitter to the TPS+PoE port of the TPS-PI-1P1 power injector by a CATx cable, and connect the TPS input port of the compatible receiver to the TPS port of the TPS-PI-1P1 by a CATx cable.
- C** **Using PoE with connecting a matrix or an input board:** connect the TPS OUT (PoE) port of the transmitter to the PoE-compatible TPS input port of the matrix or input board by a CATx cable.

ATTENTION! In case of connecting the transmitter to an input board of the matrix always connect an external PSU to the board. For the detailed information please read the user's manual of the matrix.

ATTENTION! The Ethernet port does not support PoE. Only the TPS port support PoE function.

3

Product Overview

The following sections are about the physical structure of the device, input/output ports and connectors:

- ▶ POWERING OPTIONS
- ▶ FRONT VIEW - UMX-TPS-TX100 SERIES
- ▶ REAR VIEW - UMX-TPS-TX100 SERIES
- ▶ FRONT VIEW - WP-UMX-TPS-TX100 SERIES
- ▶ REAR VIEW - WP-UMX-TPS-TX100 SERIES
- ▶ FRONT VIEW - FP-UMX-TPS-TX100 SERIES
- ▶ REAR VIEW - FP-UMX-TPS-TX100 SERIES
- ▶ ELECTRICAL CONNECTIONS
- ▶ TPS EXTENDER CONCEPT
- ▶ TPS INTERFACE
- ▶ PORT DIAGRAMS
- ▶ VIDEO INTERFACE
- ▶ THE AUTOSELECT FEATURE
- ▶ AUDIO INTERFACE
- ▶ SERIAL INTERFACE
- ▶ IR INTERFACE
- ▶ GPIO INTERFACE
- ▶ ETHERNET CONTROL INTERFACE
- ▶ USB INTERFACE (KVM FUNCTION)
- ▶ CONSUMING ELECTRONIC CONTROL (CEC) INTERFACE
- ▶ FURTHER BUILT-IN FEATURES

3.1. Front View - UMX-TPS-TX100 series

UMX-TPS-TX120



UMX-TPS-TX130

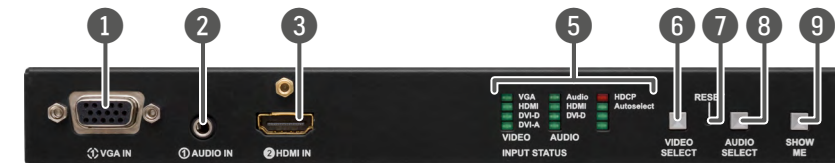

- | | | |
|---|----------------------------|---|
| 1 | VGA input | D-SUB connector for analog video signal. |
| 2 | Audio1 input | 3.5 mm Jack connector for asymmetric analog audio input signal. |
| 3 | HDMI input | HDMI connector for DVI video or HDMI video and audio. |
| 4 | DisplayPort input | DisplayPort connector for DisplayPort audio/video signal. |
| 5 | Input Status LEDs | LEDs give feedback about the current status of the unit and input signals. See the details in the Front Panel LEDs section. <i>#status</i> |
| 6 | Video Select button | Button for switching between video sources. See the details in the Video Select Button section. <i>#crosspoint #switch #testpattern #button</i> |
| 7 | Reset button | Pushing the button reboots the unit. <i>#reset #reboot</i> |
| 8 | Audio Select button | Button for switching between audio sources. See the details in the Audio Select Button section. <i>#audio #analogaudio</i> |
| 9 | Show Me button | Special functions can be reached using this button (firmware upgrade (bootload) mode, DHCP settings, restore factory default settings, condition launching in Event Manager). <i>#dhcp #factorydefault</i> |

UMX-TPS-TX140 /UMX-TPS-TX140-Plus

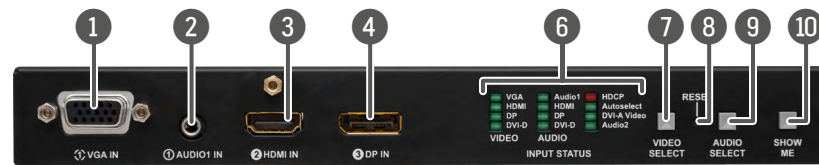

UMX-TPS-TX140K #new

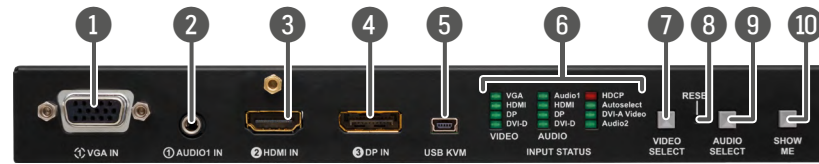

- 1 **VGA input** D-SUB connector for analog video signal.
- 2 **Audio1 input** 3.5 mm Jack connector for asymmetric analog audio input signal.
- 3 **HDMI input** HDMI connector for DVI video or HDMI video and audio.
- 4 **DisplayPort input** DisplayPort connector for DisplayPort audio/video signal.
- 5 **USB KVM** Mini-B type connector for KVM extension for USB HID (Human Interface Devices, e.g. keyboard, mouse, presenter). This port transmits the USB data from the extender towards the PC. *#usb #usbkvm*
- 6 **Input Status LEDs** LEDs give feedback about the current status of the unit and input signals. See the details in the [Front Panel LEDs](#) section. *#status*
- 7 **Video Select button** Button for switching between video sources. See the details in the [Video Select Button](#) section. *#crosspoint #switch #testpattern #button*
- 8 **Reset button** Pushing the button reboots the unit. *#reset #reboot*
- 9 **Audio Select button** Button for switching between audio sources. See the details in the [Audio Select Button](#) section. *#audio #analogaudio*
- 10 **Show Me button** Special functions can be reached using this button (firmware upgrade (bootload) mode, DHCP settings, restore factory default settings, condition launching in [Event Manager](#)). *#dhcp #factorydefault*

3.2. Rear View - UMX-TPS-TX100 series

UMX-TPS-TX120

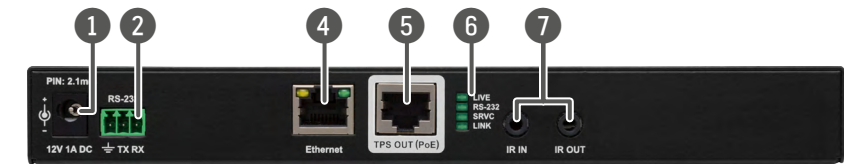

UMX-TPS-TX130

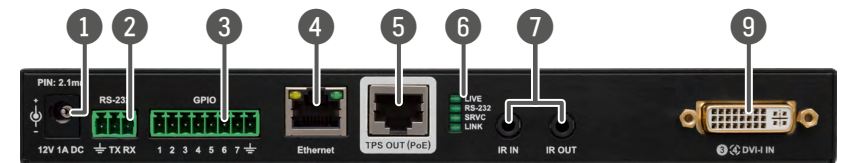

- 1 **12V DC input** 12V DC input for local powering. For more details see the [Locking 12V DC Connection](#) section or see all the available [Powering Options](#).
- 2 **RS-232 connector** 3-pole Phoenix connector for controlling the device with LDC or third-party control systems, or third-party device control. Pin assignment can be found in the [RS-232 Connector](#) section.
- 3 **GPIO** 8-pole Phoenix connector for configurable general purpose input/output ports. Pin assignment can be found in the [GPIO - General Purpose Input/Output Ports](#) section.
- 4 **Ethernet** Locking RJ-45 connector for configuring the device using Lightware Device Controller (LDC), or upgrading it using Lightware Device Updater (LDU). Any third-party control system can use this port to control the device.
- 5 **TPS OUT (PoE)** Locking RJ45 connector for HDBaseT™ signal transmission. Maximum CATx cable distances can be found in the [Maximum Extension Distances](#) section.
- 6 **Status LEDs** The LEDs give feedback about the actual state of the device. See the details in the [Rear Panel LEDs](#) section.
- 7 **IR IN and OUT** 3-pole TRS connector, also known as 3.5 mm (1/8") jack plug for optional IR receiver (IR IN) and transmitter (IR OUT) connection. Pin assignments can be found in the [IR Connector](#) section.
- 8 **Audio2 input** 5-pole Phoenix connector for balanced analog audio input. Pin assignment can be found in the [Analog Stereo Audio \(Phoenix\)](#) section.
- 9 **DVI-I input** DVI-I connector for analog / DVI / HDMI signals. Pin assignment can be found in the [DVI-I Connector](#) section.

UMX-TPS-TX140 / UMX-TPS-TX140-Plus

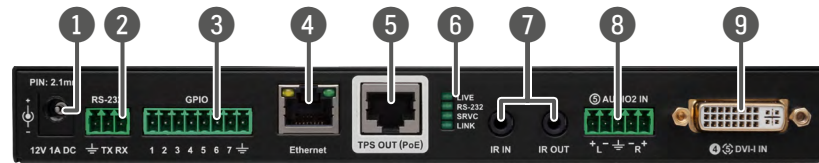

UMX-TPS-TX140K #new

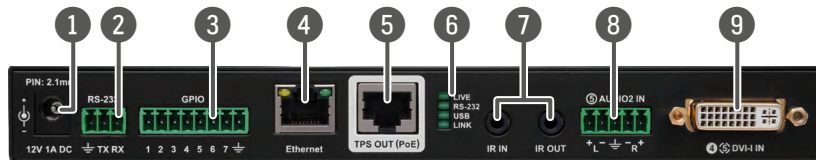

- 1 **12V DC input** 12V DC input for local powering. For more details see the [Locking 12V DC Connection](#) section or see all the available [Powering Options](#).
- 2 **RS-232 connector** 3-pole Phoenix connector for controlling the device with LDC or third-party control systems, or third-party device control. Pin assignment can be found in the [RS-232 Connector](#) section.
- 3 **GPIO** 8-pole Phoenix connector for configurable general purpose input/output ports. Pin assignment can be found in the [GPIO - General Purpose Input/Output Ports](#) section.
- 4 **Ethernet** Locking RJ-45 connector for configuring the device using Lightware Device Controller (LDC), or upgrading it using Lightware Device Updater (LDU). Any third-party control system can use this port to control the device.
- 5 **TPS OUT (PoE)** Locking RJ45 connector for HDBaseT™ signal transmission. Maximum CATx cable distances can be found in the [Maximum Extension Distances](#) section.
- 6 **Status LEDs** The LEDs give feedback about the actual state of the device. See the details in the [Rear Panel LEDs](#) section.
- 7 **IR IN and OUT** 3-pole TRS connector, also known as 3.5 mm (1/8") jack plug for optional IR receiver (IR IN) and transmitter (IR OUT) connection. Pin assignments can be found in the [IR Connector](#) section.
- 8 **Audio2 input** 5-pole Phoenix connector for balanced analog audio input. Pin assignment can be found in the [Analog Stereo Audio \(Phoenix\)](#) section.
- 9 **DVI-I input** DVI-I connector for analog / DVI / HDMI signals. Pin assignment can be found in the [DVI-I Connector](#) section.

3.3. Front View - WP-UMX-TPS-TX100 series

WP-UMX-TPS-TX120-US

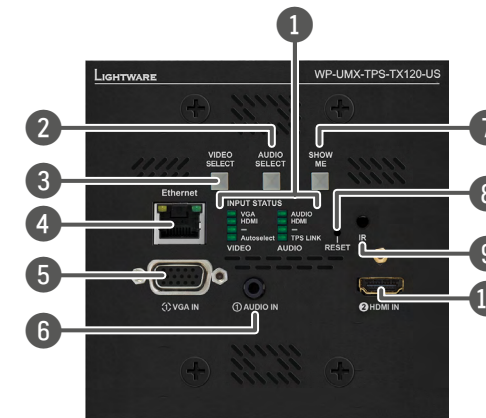

WP-UMX-TPS-TX130-US / WP-UMX-TPS-TX130-Plus-US

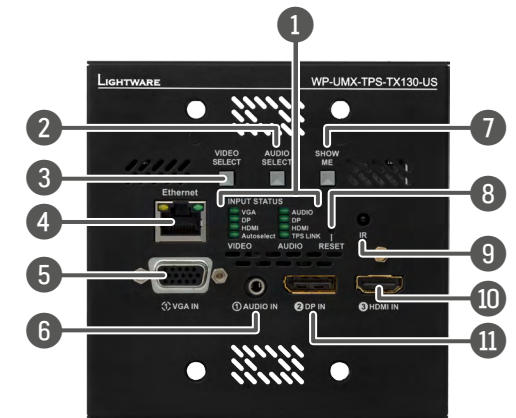

- 1 **Input Status LEDs** LEDs give feedback about the current status of the unit and input signals. See the details in the [Front Panel LEDs](#) section.
- 2 **Audio Select button** Button for switching between audio sources. See the details in the [Audio Select Button](#) section. *#audio #analogaudio*
- 3 **Video Select button** Button for switching between video sources. See the details in the [Video Select Button](#) section. *#crosspoint #switch*
- 4 **Ethernet** Locking RJ-45 connector for configuring the device using Lightware Device Controller (LDC), or upgrading it using Lightware Device Updater (LDU). Any third-party control system can use this port to control the device.
- 5 **VGA input** D-SUB connector for analog video signal.
- 6 **Audio input** 3.5 mm Jack connector for asymmetric analog audio input signal.
- 7 **Show Me button** Special functions can be reached using this button (firmware upgrade (bootload) mode, DHCP settings, restore factory default settings, condition launching in [Event Manager](#)). *#dhcp #factorydefault*
- 8 **Reset button** Pushing the button reboots the unit. *#reboot #reset*
- 9 **IR detector** IR Detector can sense IR light which can be forwarded to the receiver side or use for controlling functions.
- 10 **HDMI input** HDMI connector for DVI video or HDMI video and audio.
- 11 **DisplayPort input** DisplayPort connector for DisplayPort audio/video signal.

3.4. Rear View - WP-UMX-TPS-TX100 series

WP-UMX-TPS-TX120-US / WP-UMX-TPS-TX130-US /
WP-UMX-TPS-TX130-Plus-US

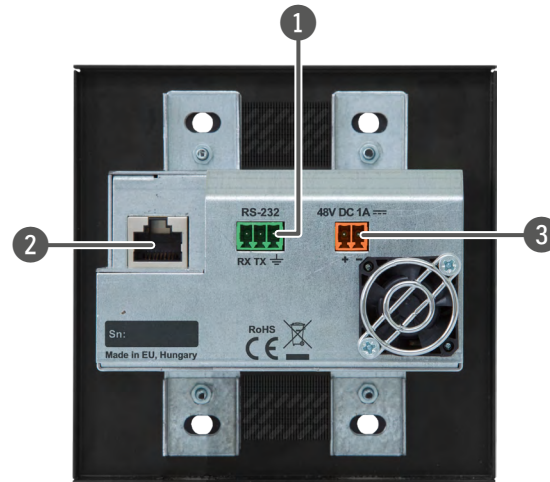

- 1 **RS-232 connector** 3-pole Phoenix connector for controlling the device with LDC or third-party control systems, or third-party device control. Pin assignment can be found in the [RS-232 Connector](#) section.
- 2 **TPS output (PoE)** Locking RJ45 connector for HDBaseT™ signal transmission. Maximum CATx cable distances can be found in the [Maximum Extension Distances](#) section.
- 3 **48V DC input** Power the device remotely by a PoE-compatible power injector (TPS-PI-1P1). If the device has to be powered by a local adaptor (PSU-48VP1), connect the output to the 2-pole Phoenix connector on the rear of the wall plate. See more details about powering options in the [48V DC Connection](#) section or see all the available [Powering Options](#).

3.5. Front View - FP-UMX-TPS-TX100 series

FP-UMX-TPS-TX120

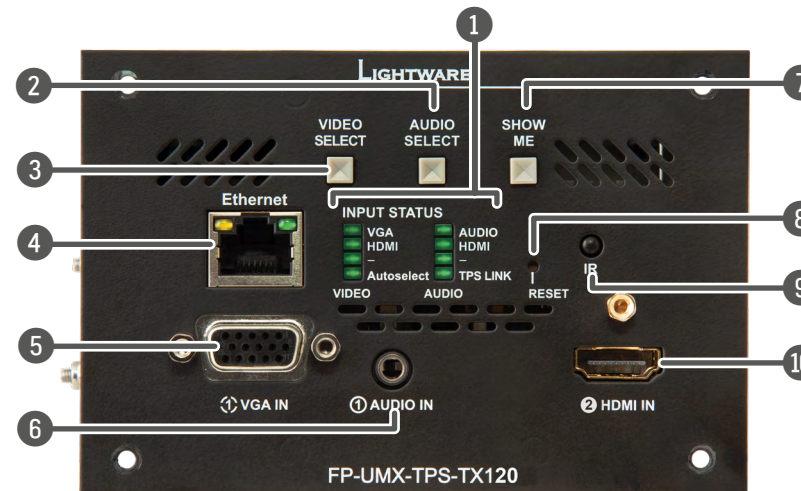

FP-UMX-TPS-TX130

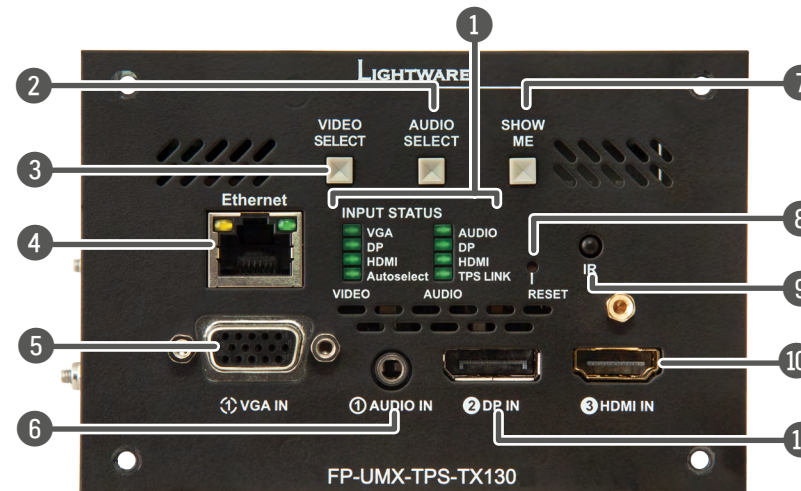

- 1 **Input Status LEDs** LEDs give feedback about the current status of the unit and input signals. See the details in the [Front Panel LEDs](#) section. `#status`
- 2 **Audio Select button** Button for switching between audio sources. See the details in the [Audio Select Button](#) section.
- 3 **Video Select button** Button for switching between video sources. See the details in the [Video Select Button](#) section.
- 4 **Ethernet** Locking RJ-45 connector for configuring the device using Lightware Device Controller (LDC), or upgrading it using Lightware Device Updater (LDU). Any third-party control system can use this port to control the device.
- 5 **VGA input** D-SUB connector for analog video signal.
- 6 **Audio input** 3.5 mm Jack connector for asymmetric analog audio input signal.
- 7 **Show Me button** Special functions can be reached using this button (firmware upgrade (bootload) mode, DHCP settings, restore factory default settings, condition launching in [Event Manager](#)).
- 8 **Reset button** Pushing the button reboots the unit.
- 9 **IR detector** IR Detector can sense IR light which can be forwarded to the receiver side or use for controlling functions.
- 10 **HDMI input** HDMI connector for DVI video or HDMI video and audio.
- 11 **DisplayPort input** DisplayPort connector for DisplayPort audio/video signal.

`#analogaudio #audio #button #crosspoint #switch #testpattern #network #dhcp #reset reboot #restart #nosyncscreen`

3.6. Rear View - FP-UMX-TPS-TX100 series

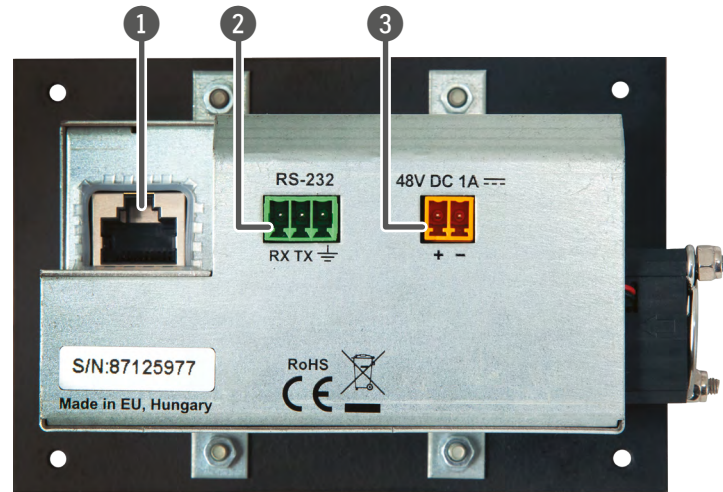

- 1 TPS output (PoE)** Locking RJ45 connector for HDBase™ signal transmission. Maximum CATx cable distances can be found in the [Maximum Extension Distances](#) section.
- 2 RS-232 connector** 3-pole Phoenix connector for controlling the device with LDC or third-party control systems, or third-party device control. Pin assignment can be found in the [RS-232 Connector](#) section.
- 3 48V DC input** Power the device remotely by a PoE-compatible power injector (TPS-PI-1P1). If the device has to be powered by a local adaptor (PSU-48VP1), connect the output to the 2-pole Phoenix connector on the rear of the floor plate. See more details about powering options in the [48V DC Connection](#) section or see all the available [Powering Options](#).

3.7. Electrical Connections

3.7.1. Locking 12V DC Connection

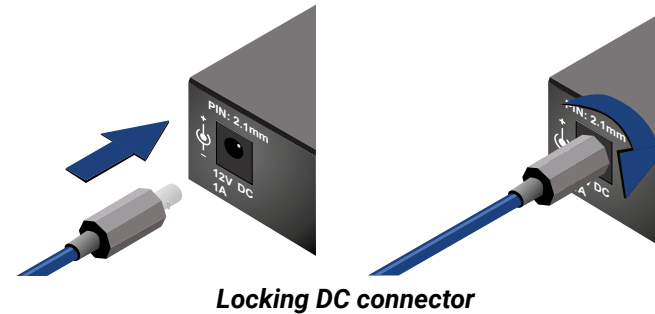

UMX-TPS-TX100 series transmitters are built with locking 12V DC connector. Do not forget to turn the plug clockwise direction before disconnecting the power adaptor. #power

WARNING! Always use the supplied 12V power adaptor. Warranty void if damage occurs due to use of a different power source.

3.7.2. 48V DC Connection

FP/WP-UMX-TPS-TX100 series transmitters are built with 2-pole Phoenix connector for 48V DC 1A power connection.



Pin nr.	Signal
1	+
2	-

2-pole Phoenix connector and plug pin assignments

3.7.3. VGA Connector

The transmitter provides a standard 15-pole D-SUB female connector for connecting VGA devices. Always use high-quality VGA cable for connecting sources and displays; using a VGA cable where all the pins are wired (including the DDC channel's wires) is highly recommended.



3.7.4. HDMI Connector

The extender provides standard 19-pole HDMI connector for input. Always use high quality HDMI cable for connecting sources and displays.



3.7.5. DisplayPort Connector

UMX-TPS-TX140,UMX-TPS-TX140-Plus,UMX-TPS-TX140K, WP-UMX-TPS-TX130-US, and WP-UMX-TPS-TX130-Plus-US models provide standard 20-pole DisplayPort connector for input. Always use high quality DP cable for connecting DisplayPort devices.

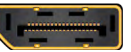

3.7.6. DVI-I Connector

UMX-TPS-TX130, UMX-TPS-TX140, UMX-TPS-TX140K and UMX-TPS-TX140-Plus transmitters provide a standard 29-pole DVI-I connector for input where digital and analog pins are connected internally. Hence users can use the connector receiving DVI-A (analog video) and DVI-D signals (digital video and digital audio) as well.

ATTENTION! Only one (DVI-A or DVI-D) mode is available at a time. You can use the Video Select button to choose the input source.

Always use high quality DVI cable for connecting DVI devices.

The following drawing and table show the pinout of DVI-I connector and the position of analog and digital signal pins.



Pin	Signal	Pin	Signal
1	TMDS Data2-	16	Hot Plug Detect
2	TMDS Data2+	17	TMDS Data0-
3	TMDS Data2 Shield	18	TMDS Data0+
4	not connected	19	TMDS Data0 Shield
5	not connected	20	not connected
6	DDC Clock	21	not connected
7	DDC Data	22	TMDS Clock Shield
8	Analog Vertical Sync	23	TMDS Clock+
9	TMDS Data1-	24	TMDS Clock-
10	TMDS Data1+	C1	Analog Red
11	TMDS Data1 Shield	C2	Analog Green
12	not connected	C3	Analog Blue
13	not connected	C4	Analog Horizontal Sync
14	+5V Power	C5	GND
15	GND (for +5V)		

3.7.7. Analog Stereo Audio (Jack)

The connector is used for receiving unbalanced analog audio signal. It is also known as (3.5 mm or approx. 1/8") audio jack, phone jack, phone plug and mini-jack plug.



Jack audio plug pin assignments

You can find more information about audio functions in the [Audio Interface](#) section.

3.7.8. Analog Stereo Audio (Phoenix)

5-pole Phoenix connector is used for balanced analog audio input in the UMX-TPS-TX140 and UMX-TPS-TX140-Plus transmitters. Unbalanced audio signals can be connected as well. See more details about the balanced and unbalanced input port wiring in the [Audio Cable Wiring Guide](#) section.

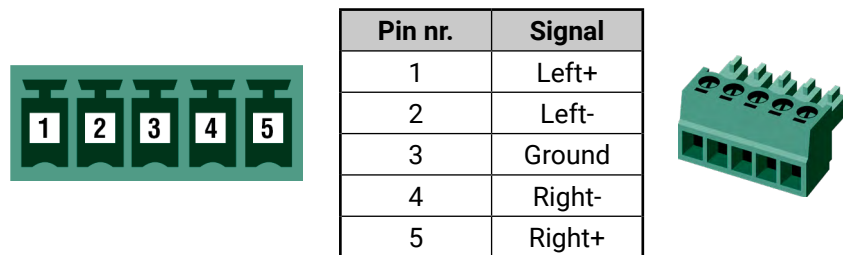

Analog audio connector and plug pin assignments

Compatible Plug Type

Phoenix® Combicon series (3.5mm pitch, 5-pole), type: MC 1.5/5-ST-3.5. You can find more information about analog audio function in the [Audio Interface](#) section.

3.7.9. Ethernet Connector (TPS and LAN Ports)

The extender provides standard RJ45 connectors for TPS IN and LAN ports. Always use high quality Ethernet cable for connecting transmitters and receivers. Maximum CATx cable distances can be found in the [Maximum Extension Distances](#) section.

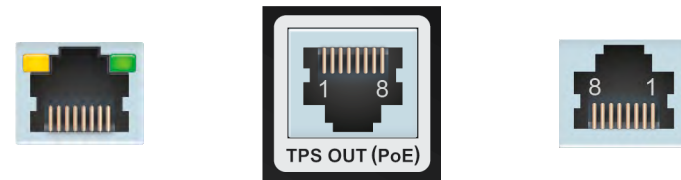

LAN connector

TPS connector of UMX-TPS-TX100 series transmitters

TPS connector of FP/WP-UMX-TPS-TX100 series transmitters

Wiring of TPS and LAN Cables

Lightware recommends the termination of LAN cables on the basis of TIA/EIA T 568 A or TIA/EIA T 568 B standards.

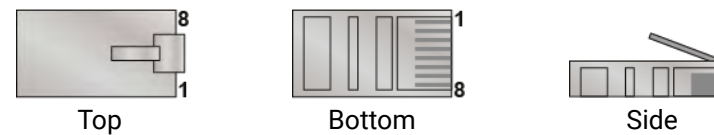

Pin	TIA/EIA T568 A	Color and name	TIA/EIA T568 B	Color and name
1		white/green stripe		white/orange stripe
2		green solid		orange solid
3		white/orange stripe		white/green stripe
4		blue solid		blue solid
5		white/blue stripe		white/blue stripe
6		orange solid		green solid
7		white/brown stripe		white/brown stripe
8		brown solid		brown solid

Pin assignments of RJ45 connector types

You can find more information about TPS interface in the [TPS Interface](#) section.

3.7.10. RS-232 Connector

The extender contains a 3-pole Phoenix connector which is used for RS-232 serial connection.



Pin nr.	Signal
1	Ground
2	TX data
3	RX data

RS-232 connector pin assignments

Compatible Plug Type

Phoenix® Combicon series (3.5mm pitch, 3-pole), type: MC 1.5/3-ST-3.5. You can find more information about RS-232 interface in the [Serial Interface](#) section.

3.7.11. IR Connector

IR detector and IR emitter can be connected to the UMX-TPS-TX100 series extenders with TRS (Tip, Ring, and Sleeve) connectors. They are also known as (3,5 mm or approx. 1/8") audio jack, phone jack, phone plug, and mini-jack plug. The pin assignments are the following for the detector and the emitter:

Detector – 3-pole-TRS		Emitter – 2-pole-TS	
1 Tip	Signal (active low)	1 Tip	+5V
2 Ring	GND	2 Ring	Signal (active low)
3 Sleeve	+5V	3 Sleeve	

INFO: Ring pole of the emitter is optional. If your IR emitter has three-pole TRS plug, then the Ring and the Sleeve are the same signal (Output -).

You can find more information about Infrared interface in the [IR Interface](#) section.

3.7.12. IR Detector

FP/WP-UMX-TPS-TX100 series transmitters are built with an IR detector on front panel of the wall plate. The sensor is used for receiving IR signals from remote control or other IR emitter devices.

You can find more information about Infrared interface in the [IR Interface](#) section.

3.7.13. GPIO - General Purpose Input/Output Ports

UMX-TPS-TX130, UMX-TPS-TX140, and UMX-TPS-TX140-Plus transmitters contain a 8-pole Phoenix connector with seven GPIO pins, which operates at TTL digital signal levels and can be set to high or low level (Push-Pull). The direction of the pins can be input or output (adjustable). Voltage ranges for GPIO inputs are the following:

	Input voltage [V]	Output voltage [V]	Max. current [mA]
Logical low level	0 - 0.8	0 - 0.5V	30
Logical high level	2 - 5	4.5 - 5V	18

INFO: The maximum total current for the seven GPIO pins is 180 mA.

Pin nr.	Level and direction
1	Configurable
2	
3	
4	
5	
6	
7	
Ground	

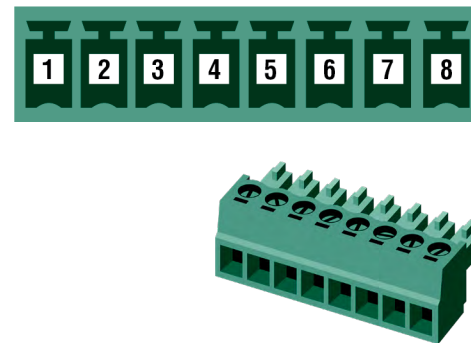

GPIO connector and plug pin assignments

Compatible plug type

Phoenix® Combicon series (3.5mm pitch 8-pole), type: MC 1.5/8-ST-3.5.

You can find more information about GPIO interface in the [GPIO Interface](#) section.

3.7.14. USB Port

DIFFERENCE: Only the UMX-TPS-TX140K model supplied with USB port. *#new*



The USB port allow USB extension and control the transmitter. The UMX-TPS-TX140K are assembled with mini-B type port (connecting a computer). For more information about the USB extension see the [USB Interface \(KVM Function\)](#) section.

3.8. TPS Extender Concept

The UMX-TPS-TX100 series transmitters and wall plates are universal audio/video extenders with analog/digital conversion and audio embedding functions. The devices receive analog (VGA, DVI-A) and digital (DP, HDMI, DVI-D) video signals and transmits HDBaseT (TPS) signal including HDMI/DVI audio/video signals, Ethernet, RS-232, and Infrared signals. Analog audio signals can be received via the 3.5" TRS (jack) and the 5-pole Phoenix connectors.

The device can be controlled via Ethernet, RS-232 or Infrared and is able to control third-party devices via the RS-232, Ethernet, Infrared interfaces.



- + Ethernet
- + RS-232
- + Infrared
- + GPIO ²
- + USB ⁴

The summary of the interfaces of UMX-TPS-TX100 series transmitters



- + Ethernet
- + RS-232
- + Infrared

The summary of the interfaces of WP- and FP -UMX-TPS-TX100 series transmitters

¹ Only for UMX-TPS-TX140, UMX-TPS-TX140K and UMX-TPS-TX140-Plus models.
² Only for UMX-TPS-TX130, UMX-TPS-TX140, UMX-TPS-TX140K and UMX-TPS-TX140-Plus models.
³ Only for WP-UMX-TPS-TX130-US, WP-UMX-TPS-TX130-Plus-US, and FP-UMX-TPS-TX130 models.
⁴ Only for UMX-TPS-TX140K model.

3.9. TPS Interface

The device is built with TPS (Twisted Pair Single) interface which are using HDBaseT™ technology. It means the unit transmits video, audio, Ethernet, RS-232, and Infrared signals via a single CATx cable.

TPS Interface Working Modes

The TPS working mode between the transmitter and the receiver is determined by the mode set in them. Both devices TPS mode settings together determine the finally established TPS transmission mode.

The following TPS modes are defined in the transmitter:

- **Auto:** The TPS mode is determined automatically.
- **HDBaseT:** Ideal for high resolution signals up to 4K.
- **Long reach:** Ideal for big distances up to 1080p@60Hz with extended cable lengths.
- **LPPF1*:** Only RS-232 communication is transmitted (@ 9600 baud).
- **LPPF2*:** Only RS-232 (@ 9600 baud) and Ethernet communication are transmitted.

* LPPF: Low Power Partial Functionality.

		Selected mode on RX side				
		LPPF1	LPPF2	HDBaseT	Long reach	Auto
Selected mode on TX side	LPPF1	LPPF1	LPPF1	LPPF1	LPPF1	LPPF1
	LPPF2	LPPF1	LPPF2	LPPF2	LPPF2	LPPF2
	HDBaseT	LPPF1	LPPF2	HDBaseT	Long reach	HDBaseT
	Long reach	LPPF1	LPPF2	Long reach	Long reach	Long reach
	Auto	LPPF1	LPPF2	HDBaseT	Long reach	HDBaseT **

** If there is valid HDMI/DVI signal is on the TX side, the TPS mode will be HDBaseT on both side. If the transmitter does not transmits HDMI/DVI signal, the TPS mode will be changed to LPPF2 or LPPF1 automatically. Long reach mode is not available when both sides are set to Auto mode.

When using automatic operation mode selection, the device determines the mode of operation. If both halves are set to Auto mode, the source side is the initiator. It will negotiate each state transition with its sink side partner.

When one of the devices is configured to manual operation mode selection, the other device may be placed in automatic mode. In this case, the mode transition negotiation is initiated by the host-managed device and the auto-mode device follows through. The allowed cable lengths and resolutions are listed in the [Maximum Extension Distances](#) section.

3.10. Port Diagrams

3.10.1. Standalone Extenders

The following figure describes the port diagram of the UMX-TPS-TX140 transmitter. The principle of the operation is the same for the following models.

- UMX-TPS-TX120
- UMX-TPS-TX130
- UMX-TPS-TX140
- UMX-TPS-TX140-Plus
- UMX-TPS-TX140K

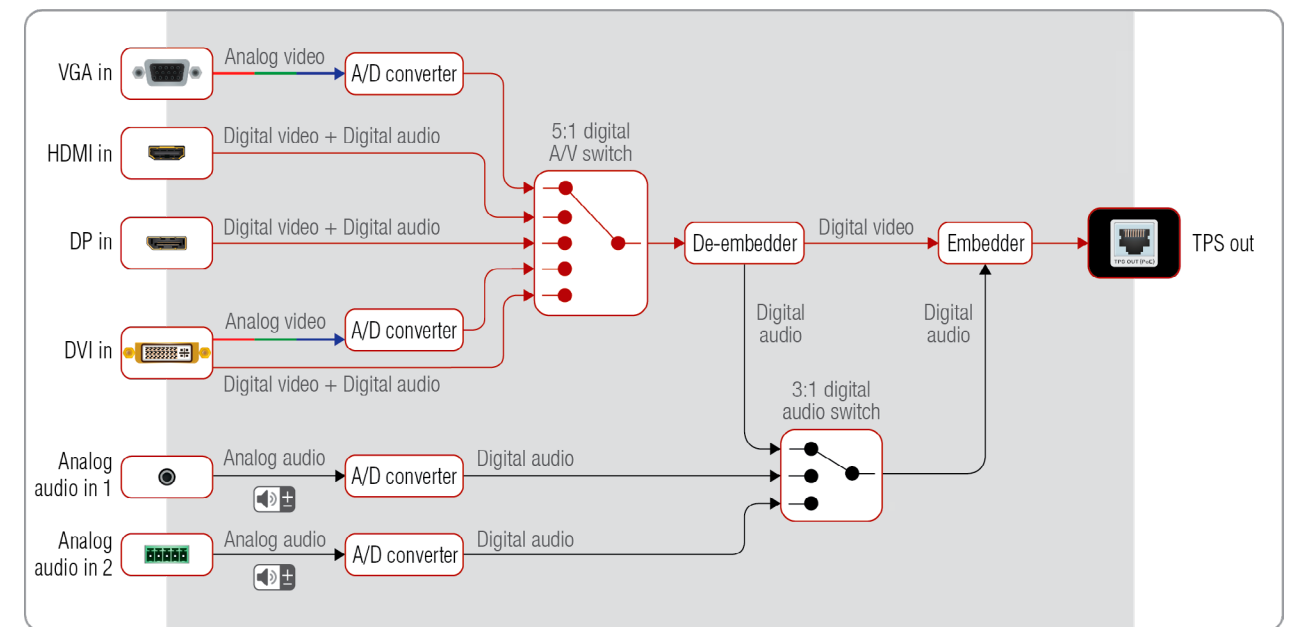

Port diagram of the UMX-TPS-TX140 transmitter

The device has four video input ports to receive analog video (VGA, DVI-A) and digital video (HDMI, DP, DVI-D) signals. The analog signals are converted to digital. A 5:1 digital audio/video switch decides which signal is routed toward the TPS output port. The device also has two analog audio input ports (3.5mm Jack, 5-pole Phoenix). The analog signals are converted to digital ones. The user can choose which audio signal is transmitted on the TPS output port: one from the analog audio sources or the original embedded audio from the HDMI / DP / DVI-D ports.

INFO: The DVI-D input accepts HDMI signal with embedded audio as well.

Besides, the device has four different interfaces to control the unit itself or third-party devices: infrared (input and output), RS-232, Ethernet, and GPIO.

3.10.2. Wall Plate / Floor Plate Extenders

The following figure describes the port diagram of the WP-UMX-TPS-TX130-US transmitter. The principle of the operation is the same for the following models.

- WP-UMX-TPS-TX120-US series
- WP-UMX-TPS-TX130-US series
- WP-UMX-TPS-TX130-Plus-US series
- FP-UMX-TPS-TX120
- FP-UMX-TPS-TX130

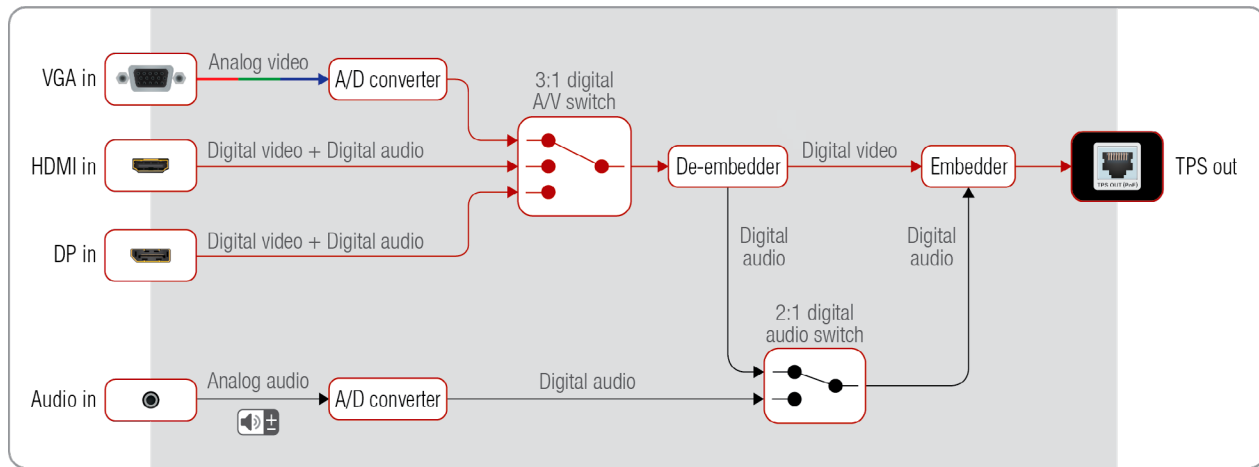

Port diagram of the WP-UMX-TPS-TX130-US transmitter

The device has three video input ports to receive analog video (VGA) and digital video (HDMI, DP) signals. The analog signal is converted to digital. A 3:1 digital audio/video switch decides which signal is routed toward the TPS output port. The device also has an analog audio input port (3.5mm Jack). The analog signals are converted to digital ones. The user can choose which audio signal is transmitted on the TPS output port: the analog audio source or the original embedded audio from the HDMI / DP ports.

Besides, the device has four different interfaces to control the unit itself or third-party devices: infrared (input), RS-232, and Ethernet.

3.11. Video Interface

3.11.1. Video Input Modes

The device can receive digital video signal on the HDMI, DisplayPort, and DVI-D input ports and analog video signal on the VGA and the DVI-A input ports.

INFO: Both the DVI-A and DVI-D signals can be received on the same DVI-I input port.

3.11.2. Input Source Selection Modes

Video input source can be selected the following ways:

- pressing **Video Select** button on the device;
- using Lightware Device Controller (LDC);
- sending LW2 or LW3 protocol commands; or
- using the **Autoselect** function.

3.12. The Autoselect Feature

There are three types of Autoselect as follows.

- **First detect mode:** selected input port is kept connected to the output as long as it has an active signal.
- **Priority detect mode:** always the highest priority active input is selected to transmit.
- **Last detect mode:** always the last attached input is selected to transmit.

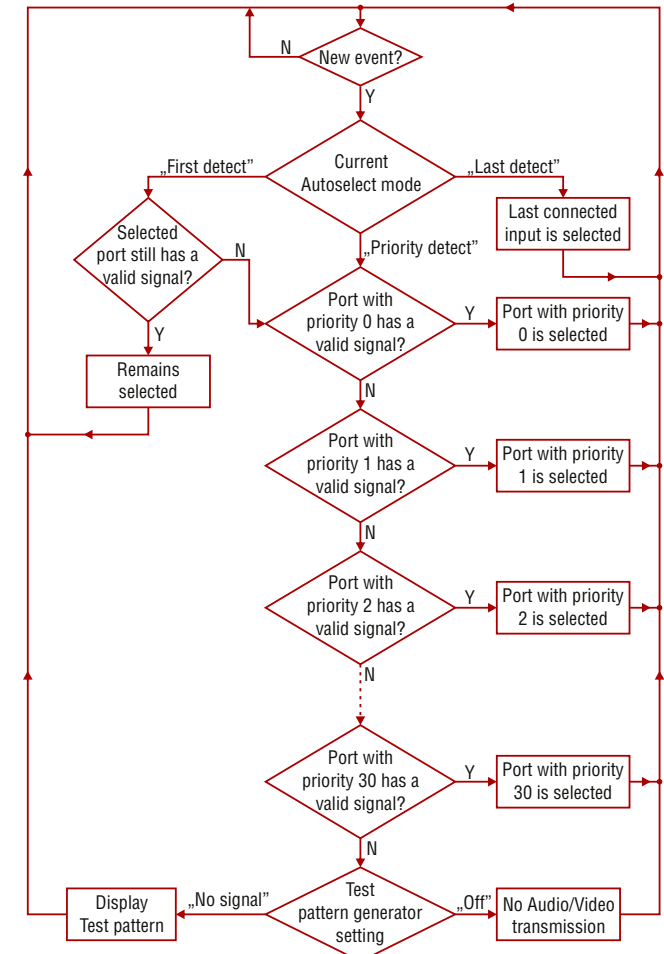

Automatic Input Selection - Example

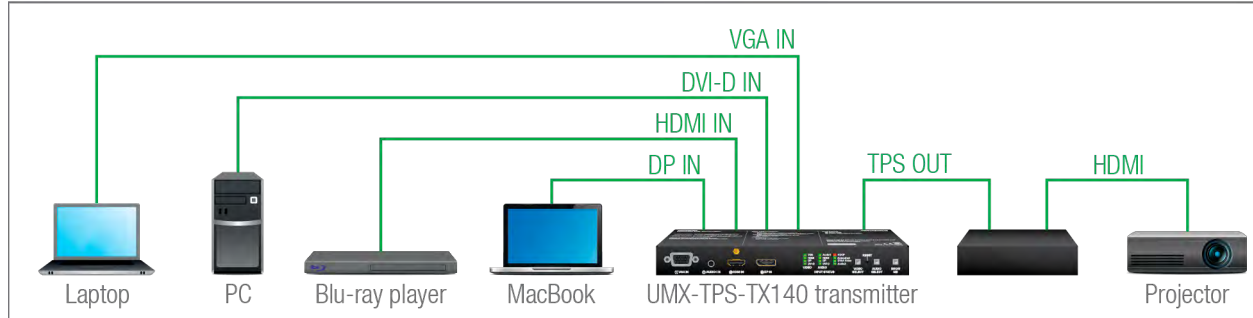

The Concept

If there is no other source connected to the transmitter, but the Laptop, VGA input will be automatically switched to the TPS output. If the Laptop and the PC are also connected to the transmitter, DVI-D input will be switched to the TPS output. If the Blu-ray player is connected on the HDMI input, and later the MacBook is connected on the DP input of the transmitter, it will be switched to the TPS output – independently of the presence of other video signals.

Settings

- **TPS output:** Set the Autoselect to **Enabled**. Set Autoselect mode to **Priority detect**. The priorities are the following (the lowest number means the highest priority):

Source device	Input interface	Input port	Priority
MacBook	DP IN	I3	0
Blu-ray player	HDMI IN	I2	1
PC	DVI-D IN	I4	2
Laptop	VGA IN	I1	3

Priorities can be set in Lightware Device Controller software, see related settings in the [TPS Video Output](#) and the [TPS Audio Output](#) sections.

3.13. Audio Interface

3.13.1. Audio Input Modes

The device can receive embedded digital audio signal on the HDMI, DisplayPort, and DVI-D input ports and analog audio signal on the Jack and the Phoenix input ports.

Audio Embedding

The transmitter has a built-in audio embedder function which means the audio signal being received on the analog audio input port can be embedded to the TPS output.

The video and audio inputs can be combined with limitations. Below table contains the allowed connections:

		Audio sources				
		HDMI	DP	DVI-D	Analog audio (Jack)	Analog audio (Phoenix)
Video sources	HDMI	✓	-	-	✓	✓
	DP	-	✓	-	✓	✓
	DVI-D	-	-	✓	✓	✓
	VGA	-	-	-	✓	✓
	DVI-A	-	-	-	✓	✓

Allowed audio connections

ATTENTION! Audio embedding is available where the pixel clocking of the video signal is up to 225 MHz. If the output video is 4K, the audio embedding function is not available.

3.13.2. Audio Options - Example

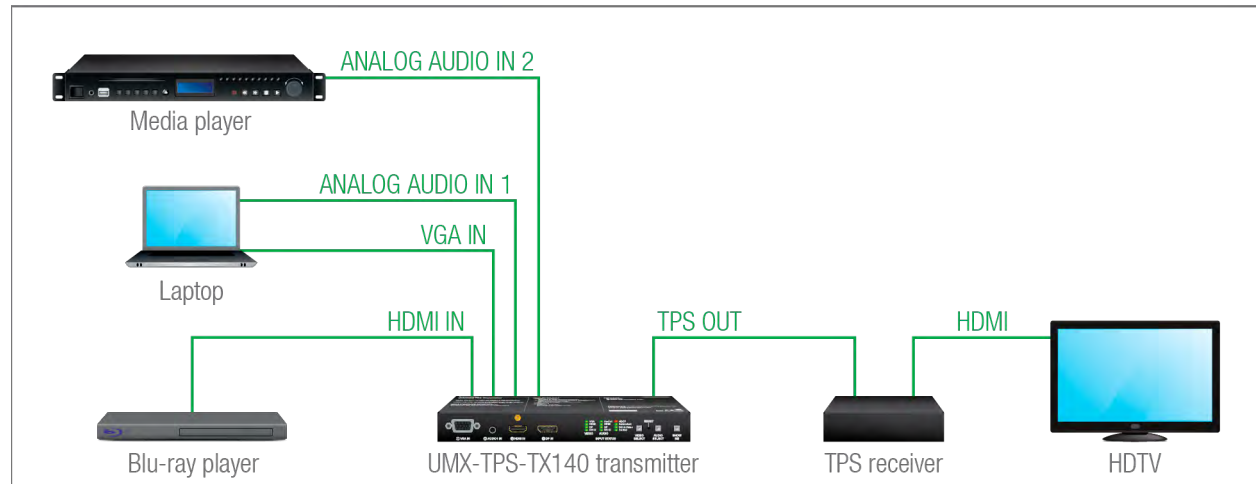

The Concept

Three audio sources are connected to the transmitter: a Blu-ray player on the HDMI input (embedded HDMI audio); a Laptop on the analog audio input 1; and a Media player on the analog audio input 2. There are two video sources as well: the Blu-ray player on the HDMI input (digital video with the embedded audio) and the Laptop on the VGA input (analog video).

The following options are available for audio routing / signal selection:

- If the video input source of the **HDTV** is the **Blu-ray player**, you can select from the following audio sources:
 - the original embedded HDMI audio from the **Blu-ray player**;
 - the analog audio input 1 from the **Laptop**;
 - the analog audio input 2 from the **Media player**.
- If the video input source of the **HDTV** is the **Laptop**, you can select from the following audio sources:
 - the analog audio input 1 from the **Laptop**;
 - the analog audio input 2 from the **Media player**.

3.14. Serial Interface

3.14.1. Technical Background

Serial data communication can be established via the local RS-232 port (Phoenix connector) or via the TPS lines. The RS-232 ports – which are connected to the CPU – can be configured separately (e.g. if the Baud rates are different, the CPU does the conversion automatically between the ports). The RS-232 port can be switched to Pass-through mode, Control mode, or Command Injection mode; see the figure below.

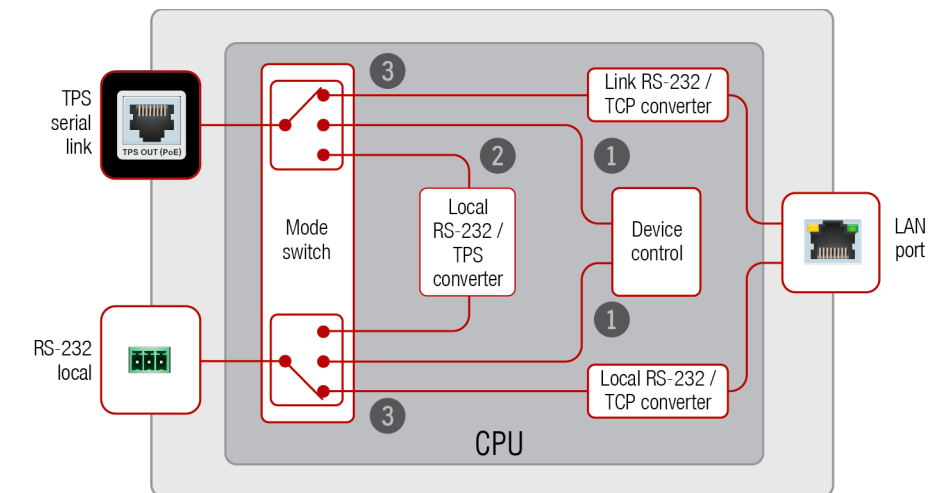

Block diagram of the serial interface

The following settings are defined:

- 1 The Local and the TPS serial ports are in **Control mode**.
- 2 The Local and the TPS serial ports are in **Pass-through mode**.
- 3 The Local and the TPS serial ports are in **Command Injection mode**.

INFO: All settings are available in the LDC software, see settings in the [RS-232 Tab](#) section.

Only one mode can be used at the same time: Control mode, or Pass-through mode, or Command Injection mode. If you choose one of them, TPS serial link and local RS-232 port will operate in the same mode.

Pass-through Mode

In pass-through mode, the given device forwards the data that is coming from one of its ports to another same type of port. The command is not processed by the CPU. Incoming serial data is forwarded from local RS-232 port to the TPS output port and vice versa inside the transmitter.

Control Mode

The incoming data from the given port is processed and interpreted by the CPU. The mode allows to control the transmitter directly. LW2 or LW3 protocol commands are accepted – depending on the current port setting.

Command Injection Mode

In this mode, the transmitter works as an RS-232 bidirectional converter. The TPS signal is converted to RS-232 data and vice versa. TCP/IP port numbers are defined for the serial ports (TPS and local) for this purpose. E.g. the default Command Injection port number of the local RS-232 port is 8001. If a command is coming from the TPS interface which addresses to the port no. 8001, it will be transmitted to the Tx pin of the local RS-232 port. That works in the opposite direction of course and the method is the same on the serial interface of the TPS port as well.

3.14.2. RS-232 Signal Transmission – Example

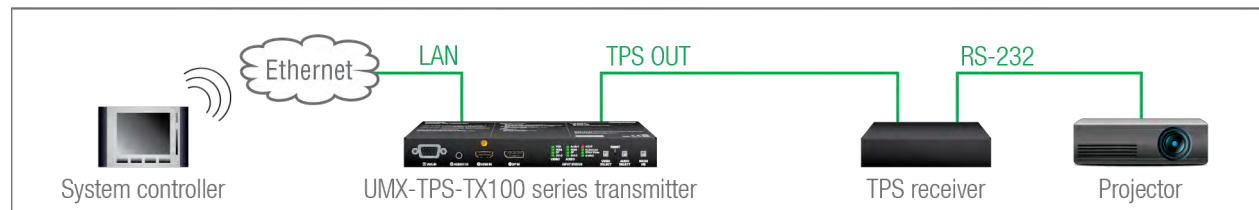

The Concept

The System controller can send commands to the transmitter and it is able to remote control the projector through the TPS receiver via RS-232.

Settings

- **System controller:** wireless IP connection to the same Ethernet as the transmitter is connected to. Use a dedicated software tool (e.g. a terminal) which is suitable for sending commands via TCP/IP to a certain IP:port address.
- **Transmitter:** set the RS-232 mode to Command Injection on TPS output port. Set the further parameters (Baud rate, Data bits, etc.) in accordance with the specifications of the projector. The transmitter will transmit the RS-232 data toward the receiver.
- **Receiver:** set the RS-232 mode to Pass-through on RS-232 port.
- **Projector:** note the RS-232 port setting that is specified by the Manufacturer. Connect a suitable serial cable with the proper wiring.

3.14.3. RS-232 Recognizer

DIFFERENCE: This feature is available only in UMX-TPS-TX140-Plus, UMX-TPS-TX140K and WP-UMX-TPS-TX130-Plus-US models.

RS-232 Recognizer Example

When the UMX-TPS-TX140-Plus has an active video signal, the transmitter login the VC codec automatically.
Steps and Settings

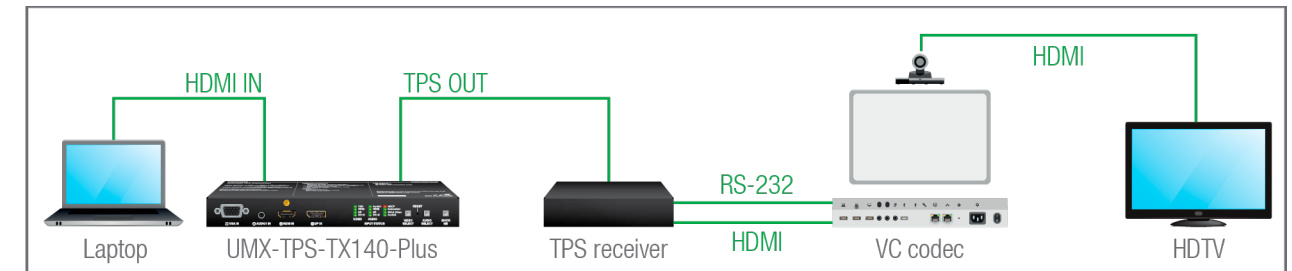

Process

When signal presents on any HDMI input, the extender sends a message: 'ping'.



Video codec sends a message: 'Login name:'.



When 'Login name:' is detected in the string, the extender sends a message: 'Admin'.



Video codec sends a message: 'Password:'.



When 'Password:' is detected in the string, the extender sends a message: 'Admin'.



Login is established, Video codec is ready to use.

Settings

This condition and the action is set in Event manager.

The serial communication is scanned continuously by the recognizer in the extender and gets the 'Login name' string.

This condition and the action is set in Event manager.

The serial communication is scanned continuously by the recognizer in the extender and gets the 'Password' string.

This condition and the action is set in Event manager.

First, configure the recognizer for the serial communication, after that, set the events in the Event Manager (for more details see the [Event Manager](#) section). The RS-232 recognizer settings has to be done with Lightware Device Controller Software (see the [Message Recognizer](#) section) or with LW3 protocol commands (see the [RS-232 Recognizer](#) section).

Settings in the Event manager

- **E1.** When the signal is present on O1 port of the UMX-TPS-TX140-Plus, it sends a message 'PING' on P1 port of RS-232 to the VC codec. For more details see Message Sending via RS-232 Serial Port section.
- **E2.** Set a condition where 'Login name:' is the recognized RS-232 message. Action is sending serial message ('Admin') on the P1 port to the VC codec.
- **E3.** Set a condition where 'Password:' is the recognized RS-232 message. Action is sending serial message ('Admin') on the P1 port to the VC codec.

3.15. IR Interface

ATTENTION! For the complete usage attach an IR emitter unit to the IR OUT and an IR detector unit to the IR IN connectors.

3.15.1. Technical Background

The Infrared signal transmission is similar to the serial data communication. The transmitter contains dedicated IR I/O connection and also can transmit/receive IR signal via the TPS interface. The signal is in pronto HEX format in both cases.

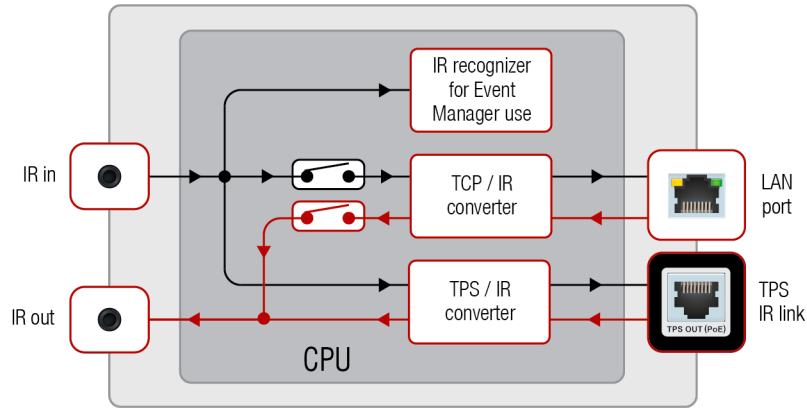

Block diagram of the IR interface - UMX-TPS-TX100 series transmitters

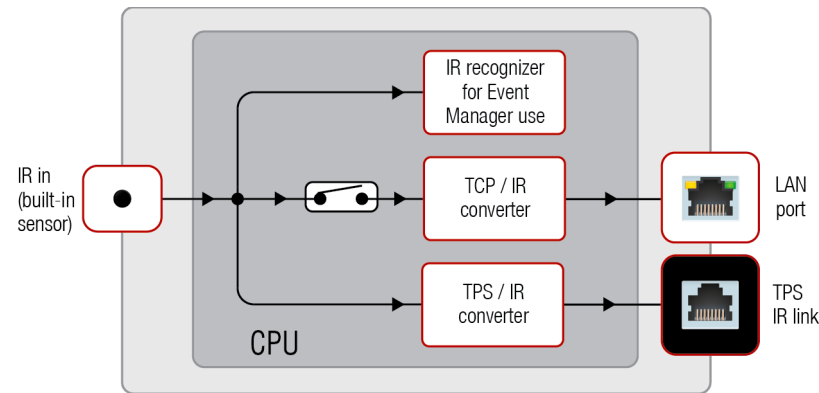

Block diagram of the IR interface - WP/FP-UMX-TPS-TX100 series transmitters

The most trivial usage of the IR interface is the transparent mode: signal received or sent on local IR ports are transmitted directly on the TPS IR link port and vice versa. Beside of this there is an IR recognizer in the device where you can assign actions in Event Manager for. The third option is the command injection mode (like at serial interface in the previous section) where you can send IR commands over LAN. Command injection mode can be turned on and off by input/output ports.

INFO: All settings are available in the LDC software, see settings in the [Infra Tab](#) section.

INFO: The modulation of output IR signal can be turned off or on by LW3 command, see details in the [Enable/Disable Output Signal Modulation](#) section.

3.15.2. IR Signal Transmission - Example 1

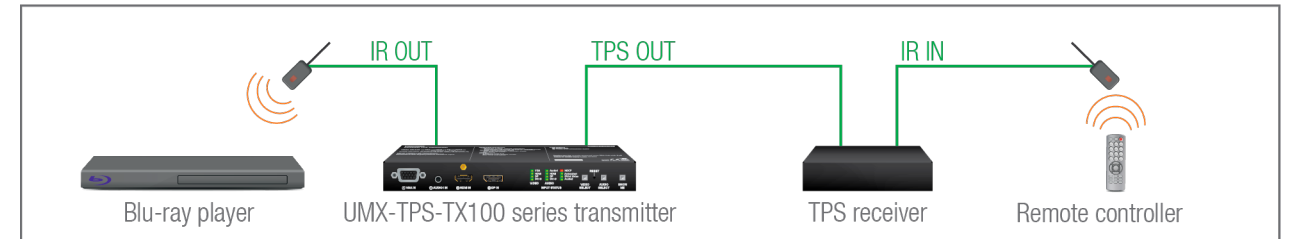

The Concept

An IR detector is attached to the Infrared input port of the TPS receiver and IR signals are sent by the Remote controller. The TPS Receiver is connected to an UMX-TPS-TX100 series transmitter built with IR output port via TPS line.

Settings:

Set the TPS IR link of the Transmitter to **Transparent mode**. IR signals are received over the local IR input port of the **Receiver** by the Remote controller. The signals transmitted further over the TPS line to the **Transmitter** which can control the **Blu-ray player** via an IR emitter.

3.15.3. IR Signal Transmission - Example 2

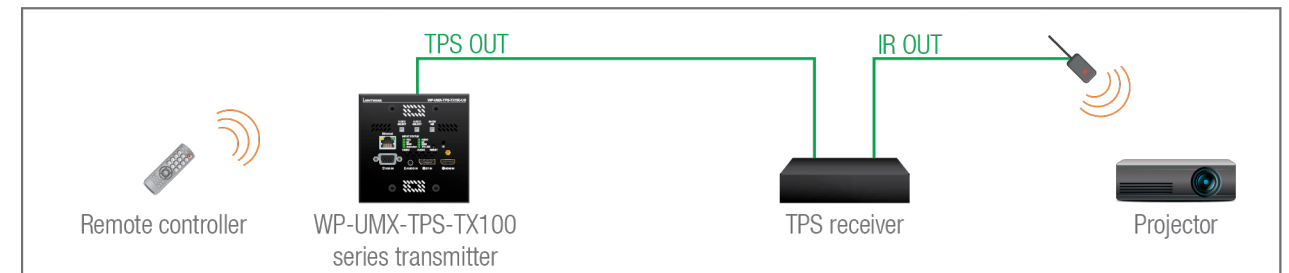

The Concept

The **built-in IR detector** of the Wallplate transmitter receives the IR signals from the **Remote controller**. The signal is transmitted via the TPS line to the **TPS receiver**. In this way the Remote controller can control the the **Projector** via the **Wallplate transmitter**.

3.15.4. Advanced IR functionality

DIFFERENCE: UMX-TPS-TX140-Plus, UMX-TPS-TX140K and WP-UMX-TPS-TX130-Plus-US can send Little-endian pronto hex IR codes on its IR output port.

It is possible in the following ways:

- With Lightware Device Controller software (for more details see [Sending pronto hex codes \(Little-endian format\)](#) section)
- With Event Manager (for more details see [Sending pronto hex codes \(Little-endian format\)](#) and [Event Manager](#) section)
- With LW3 protocol command (for more information see [Sending Pronto Hex Codes in Little-endian Format via IR Port](#))

Sending Bigger-endian pronto hex code is also available, see [Sending Pronto Hex Codes in Big-endian Format via IR Port](#).

3.16. GPIO Interface

3.16.1. Description

The GPIO (General Purpose Input/Output) port is a multifunctional input/output interface to control the transmitter or third-party devices and peripherals. You can establish connection between the controller/controllable device and the transmitter by the 8-pole Phoenix connector. Seven pin's direction is configurable independently based on needs of the application.

3.16.2. GPIO Options - Example

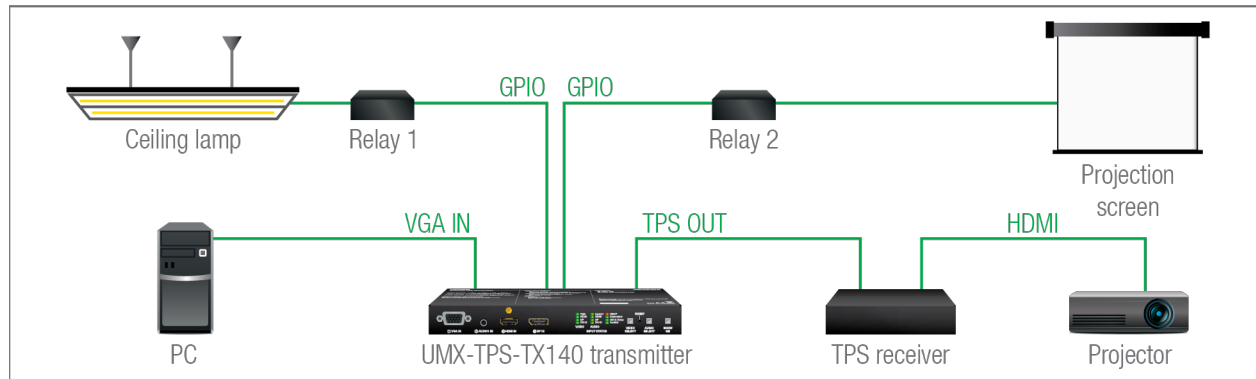

The Concept

Ceiling lamp is turned off by Relay 1 and projection screen is rolled down by Relay 2 when signal received from the PC over the VGA input. Both relays are controlled by the GPIO port.

Settings of the Transmitter

- **For Relay 1:** create an event in Event manager: when signal is present on Input 1 (I1) then set GPIO pins to low level for Relay 1 opening. Also create another event when signal is not present on Input 1 (I1) then set GPIO pins to high level for Relay 1 closing.
- **For Relay 2:** create an event in Event manager when signal is present on Input 1 (I1) then set GPIO pins to high level for Relay 2 closing. Also create another event when signal is not present on Input 1 (I1) then set GPIO pins to low level for Relay 2 opening.

When the PC starts to play the video presentation, the signal is received over the VGA input so GPIO pins send signal to Relay 1 to open which results turning off the lights. Furthermore GPIO pins also send signal to Relay 2 to close and the projection screen is rolled down. When the presentation is ended, signal ceases on the VGA input, so GPIO pins send signal to Relay 1 to close which results turning on the lights and sends signal to Relay 2 to open so projection screen returns to its enclosure.

ATTENTION! Please always check the electrical parameters of the devices what you want to control. The maximum current of one GPIO pin is 30 mA, the maximum total current for the seven pins is 180 mA.

See the LDC settings for GPIO port in the [GPIO Tab](#) section. See also the details about the Event Manager settings in the [Event Manager](#) section.

3.17. Ethernet Control Interface

The device can be controlled over front panel Ethernet standard RJ45 connector which connected to LAN. This interface supports both LW2 and LW3 protocols.

The interface can be used to remote control the device with Lightware Device Controller and establish the connection to Lightware Device Updater software and perform firmware upgrade.

3.18. USB Interface (KVM Function)

DIFFERENCE: Only the UMX-TPS-TX140K model supplied with USB port. `#new #usb #usbkvm`

UMX-TPS-TX140K model supports HID-compliant (Human Interface Device) devices to transmit USB signal between the source and sink devices. The UMX-TPS-TX140K transmitter connects to the controlled device (e.g. PC) and the controlling devices (e.g. computer mouse, keyboard, touch panel) are connected to the compatible receiver.

ATTENTION! The compatible receiver for the USB KVM extension is HDMI-TPS-RX220AK.

The device can be controlled over front panel USB mini B-type connector. This interface only supports LW3 protocol. The interface can be also used to establish a connection to [Lightware Device Controller](#) software.

ATTENTION! Only HID-compliant devices are supported by the extenders. Non-HID devices (USB sticks, webcams, etc.) will not be working with the UMX-TPS-TX140K.

ATTENTION! USB HUB devices are not supported by the UMX-TPS-TX140K transmitter.

Technical background

The same USB data is transmitted on the RX side which is received on the TX side. The content of the transmitted packets are unknown to the Lightware infrastructure so the data is not modified by any means during transmission.

Key Features:

- Supports all HID-compliant devices.
- Driver software for all connected USB devices has to be installed on the controlled computer. The connected mouse and keyboard will be detected as a new hardware in the operating system.

USB KVM Function - Example

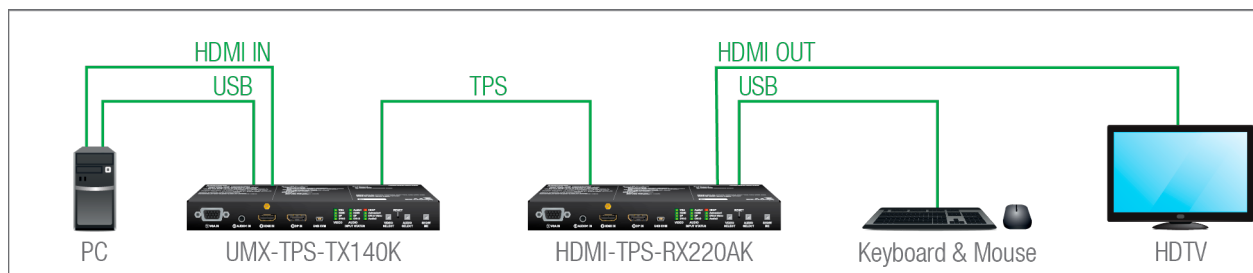

The Concept

The PC is the sink device for the USB KVM function. The HDMI-TPS-RX220AK receiver is connected to the TPS output of the transmitter via CATx cable. The keyboard and the mice are connected to the receiver at the end user side.

There is no restriction on the USB-HID devices if the driver is installed on the connected computer the USB KVM signal is transmitted to the receiver without any limitation.

3.19. Consuming Electronic Control (CEC) Interface

DIFFERENCE: This feature is available only in UMX-TPS-TX140-Plus, UMX-TPS-TX140K and WP-UMX-TPS-TX130-Plus-US models.

Consumer Electronic Control (CEC) is a bi-directional communication, defined in the HDMI standard. This feature is for remote control of the source and sink devices in the A/V system.

UMX-TPS-TX140-Plus model is able to send and receive CEC commands, on HDMI IN (I2) port towards the source, on HDMI OUT (O1) port towards the sink. For more information about sending CEC messages, see [Sending CEC Commands](#) section.

CEC has a dedicated pin in the HDMI connector. DVI connector does not contain this pin, so the CEC transmission brakes when HDMI-DVI connector or adapter is in the signal route.

CEC Application Example

When active signal is detected on HDMI in, the transmitter sends a CEC message automatically to the HDTV to wake up.

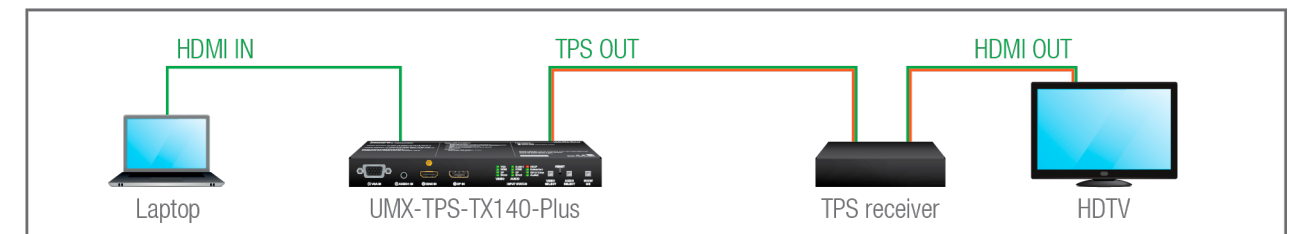

Create an event in the event manager:

- Set as a condition, that the signal is present on the output (O1),
- Set as an action then send a CEC command 'Image view on' O1 output port.

See the details about the Event Manager settings in the [Event Manager](#) section.

ATTENTION! The CEC command sending over TPS interface is working only with CEC-transparent TPS receivers. For the details please download our Using CEC in Lightware Devices document on <https://lightware.com/support/guides-and-white-papers> website.

3.20. Further Built-in Features

3.20.1. Automatically Launched Actions – The Event Manager

The Event Manager feature means that the device can sense changes on its ports and is able to react according to the pre-defined settings. Lightware Device Controller contains a user-friendly software tool and allows to create Events by defining a Condition and an Action.

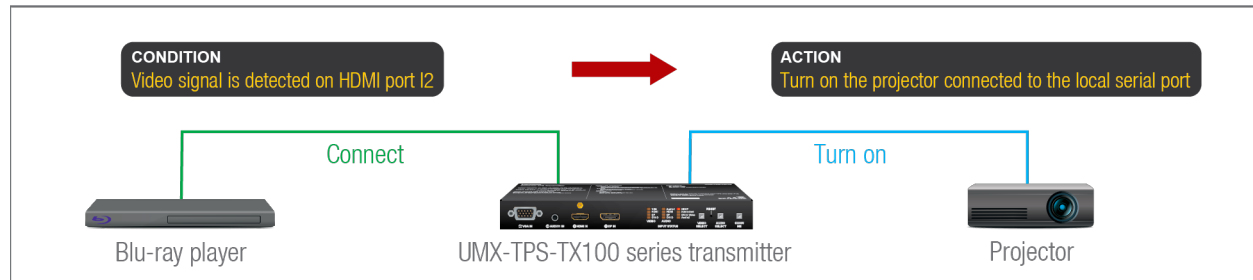

Event Manager example

See more information about the settings in the [Event Manager](#) section.

3.20.2. Transmitter Cloning – Configuration Backup and Restore

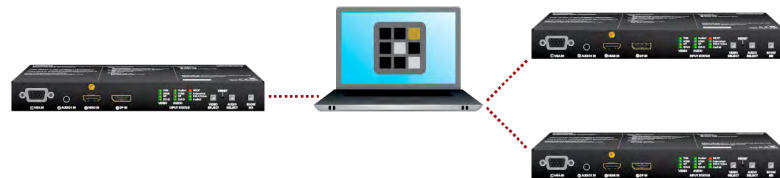

The transmitter (configuration) cloning of a UMX-TPS-TX100 series transmitter or wallplate is a simple method that eliminates the need to repeatedly configure certain devices to have identical (non-factory) settings. If the devices are installed in the same type of system multiple times then it is enough to set up only one device to fit the user's needs and then copy those settings to the others, thus saving time and resources.

See more information about the settings in the [Configuration Cloning \(Backup Tab\)](#) section.

3.20.3. Remote Firmware Upgrade of Connected Lightware Devices



The firmware of the Lightware TPS devices can be upgraded individually by Lightware Device Updater (LDU) software. UMX-TPS-TX100 series transmitters and wallplates contain a feature which allows having a faster and more comfortable firmware upgrade process. When the firmware of the connected extenders has to be upgraded the TPS connection is necessary towards the extenders – nothing else. The LDU will find the connected devices and can upgrade them.

The upgrade process is almost the same as in the case of the usual upgrade process. See the details of the process in the [Remote Firmware Upgrade of Connected Lightware Devices](#) section.

4

Operation

This chapter is about the powering and operating of the device describing the functions which are available by the front/rear controls:

- ▶ [FRONT PANEL LEDs](#)
- ▶ [REAR PANEL LEDs](#)
- ▶ [FRONT PANEL BUTTONS](#)
- ▶ [SPECIAL FUNCTIONS](#)
- ▶ [SOFTWARE CONTROL MODES](#)

4.1. Front Panel LEDs

INFO: The operation of the status LEDs of WP-UMX-TPS-TX100 series and FP-UMX-TPS-TX100 series models are the same.

ATTENTION! When Dark mode is enabled, no LEDs are on, even though the device is fully functional. `#status`

4.1.1. Video Input LEDs

- **OFF:** Video source is not selected.
- **BLINKING:** Video source is selected, and signal is not detected.
- **ON:** Video source is selected and signal is present.

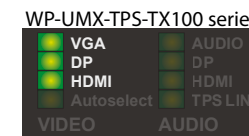
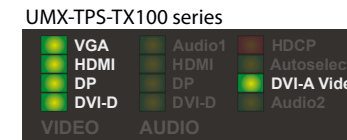

4.1.2. Audio Input LEDs

- **OFF:** Audio source is not selected. **BLINKING:** Audio source is selected, and signal is not detected.
- **ON (with short pause):** Audio source is selected and the port is active but not embedded to the output video stream (DVI output mode).
- **ON (continuously):** Audio source is selected, the port is active and the audio is embedded to the output video stream (HDMI output mode).

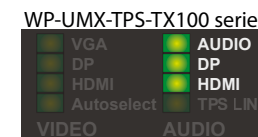
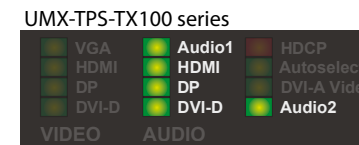

4.1.3. Autoselect LED

- **OFF:** Autoselect function is disabled. **BLINKING:** Autoselect function is enabled, searching for signal (the video input LEDs are also blinking).
- **ON:** Autoselect function is enabled, the active video signal is found (the selected video input's LED is also ON).

You can find more details in the [The Autoselect Feature](#) section.

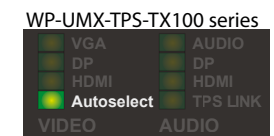
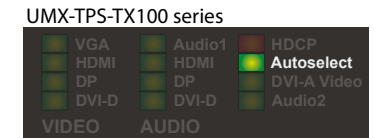

4.1.4. HDCP LED

- **OFF:** Video output signal is not encrypted with HDCP.
- **ON:** Video output signal is HDCP-encrypted.

You can find more details in the [HDCP Management](#) section.



4.1.5. TPS LINK LED

- **OFF:** No TPS link between the transmitter and the receiver.
- **BLINKING (slow):** Low power mode is active.
- **BLINKING (fast):** Ethernet fallback mode is active.
- **ON:** TPS link is established, HDBaseT or Long Reach mode is active.

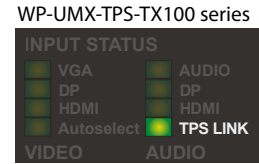

You can find more details about TPS operation modes in the [TPS Interface](#) section.

4.1.6. Firmware Version Indication

After being powered on, the transmitter lights up all LEDs, then displays its firmware version using three LEDs on the front panel: the upper three in the left column. The top LED means the first number of the firmware version – actually this is the main version. The second and the third LEDs from the top indicate the second and the third numbers of the firmware version which mean the subversions. *#firmwareversion*

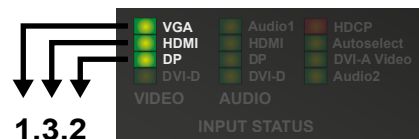

UMX-TPS-TX140

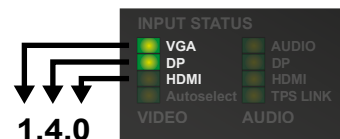

WP-UMX-TPS-TX130-US

Example - WP-UMX-TPS-TX130-US

The process after the device is switched on or rebooted is the following:

Step 6. VGA LED blinks once the first number (1).

Step 7. DP LED blinks twice the second number (2).

Step 8. HDMI LED stays dark showing the third number (0).

4.2. Rear Panel LEDs

4.2.1. LIVE LED

- **OFF:** The device is not powered.
- **BLINKING (slow):** The device is powered and operational.
- **BLINKING (fast):** The device is in firmware upgrade (bootload) mode.
- **ON:** The device is powered but not operational.



4.2.2. RS-232 LED

- **OFF:** RS-232 ports (Local and Link) are in Pass-through mode.
- **BLINKING:** Command injection mode is active.
- **ON:** RS-232 ports (Local and Link) are in Control mode.



See more details about RS-232 modes in the [Technical Background](#) section.

4.2.3. SRVC LED

- **DIFFERENCE:** The UMX-TPS-TX140K model has no SRVC LED.
- **ON:** Test pattern is the selected and active input source.



See more details about Test pattern input mode in the [Test Pattern](#) section.

4.2.4. USB KVM LED

DIFFERENCE: Only the UMX-TPS-TX140K model has USB KVM LED.

- **OFF:** No USB link between the transmitter and the controlled device (e.g. PC).
- **ON:** The USB is enumerated.

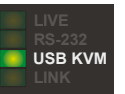

See more details in the [USB Interface \(KVM Function\)](#) section. *#new*

4.2.5. LINK LED

- **OFF:** No TPS link between the transmitter and the receiver.
- **BLINKING (slow):** Low power mode is active.
- **BLINKING (fast):** Ethernet fallback mode is active.
- **ON:** TPS link is established, HDBaseT or Long Reach mode is active.

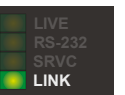

See more details about TPS modes in the [TPS Interface](#) section. *#status*

4.3. Front Panel Buttons

INFO: WP-UMX-TPS-TX130-US and FP-UMX-TPS-TX130-MKM models have the same functionality. The operation of the front panel buttons is also similar. *#button #crosspoint #switch*

4.3.1. Video Select Button

Desired video input can be selected by the **Video Select button** from the front panel. The selection order of the inputs depends on the model as follows:

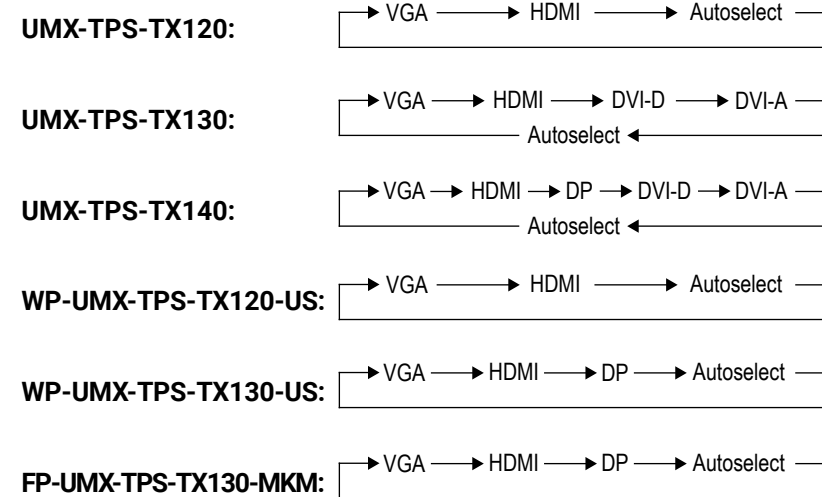

4.3.2. Audio Select Button

Desired audio input can be selected by the **Audio Select button** from the front panel. The selection order of the inputs depends on the model as follows:

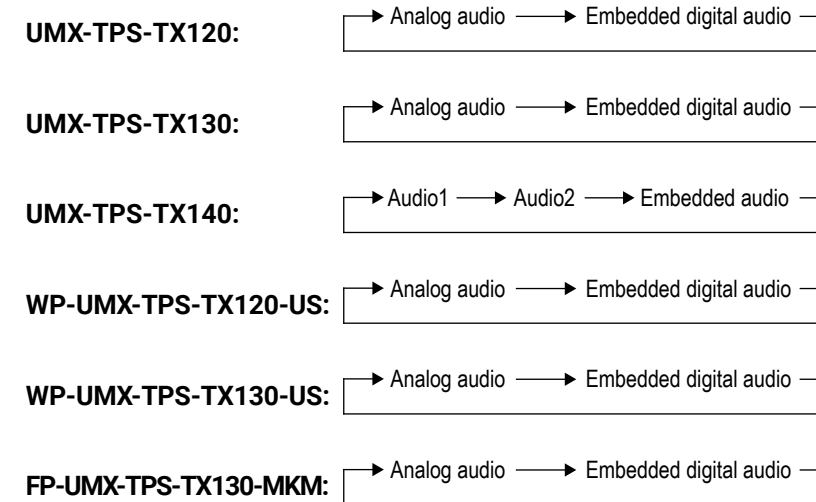

INFO: Embedded digital audio is received on the digital video input port (HDMI / DP / DVI-D) which is currently selected. If analog video input signal (VGA / DVI-A) is selected which cannot contain embedded audio, this source is skipped. *#audio #analogaudio*

4.3.3. Port Legend

- ① Video only
- ① Audio only
- ② Video with embedded audio

4.3.4. Programmable Show Me Button

Action or an operation can be assigned to the Show Me button. “**Show Me button pressed**” is a condition that can be selected in the Event Manager. See more details in the [Event Manager](#) section.



4.4. Special Functions

4.4.1. Enable DHCP (Dynamic) IP Address



The device has a static IP address as a factory default setting. If this setting does not fit to the circumstances during install or usage, DHCP can be enabled from the front panel:

- Step 1.** Make sure the device is powered on and operational.
- Step 2.** Press and keep pressed the **Show Me** button for 5 seconds.
- Step 3.** After 5 seconds front panel LEDs start blinking; release the button and press it 3 times again quickly (within 3 seconds).
- Step 4.** The LEDs get dark, DHCP gets enabled. *#network #dhcp*

4.4.2. Reset to Factory Default Settings



To restore factory default values, do the following steps:

- Step 1.** Make sure the device is powered on and operational.
- Step 2.** Press and keep pressed the **Show Me** button for 10 seconds. After 5 seconds front panel LEDs start blinking but keep on pressing the button.
- Step 3.** After 10 seconds the LEDs start blinking faster; release the button and press it 3 times again quickly (within 3 seconds).
- Step 4.** The LEDs get dark, the device restores the factory default settings and reboots.

Factory default settings are listed in the [Factory Default Settings](#) section. *#factorydefault*

4.4.3. Resetting the Device

In few cases (after firmware upgrade, etc) you may need to reset the device. Pushing the reset button results the same as you disconnect and reconnect the power adaptor to the transmitter. To resetting the device follow the steps:

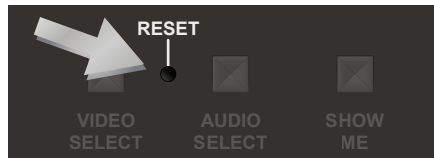

Step 1. Push the button with a thin object for a second.

Step 2. Wait until the device reboots. You can use the transmitter when the LIVE LED is blinking slowly again.

ATTENTION! Resetting the device does not reset the settings to factory defaults. To reset factory default settings see the previous section. *#reset #reboot #restart*

4.4.4. Control Lock

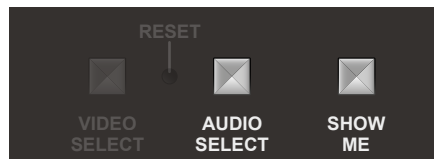

Press the **Audio Select** and **Show Me** buttons **together** (within 100 ms) to disable/enable front panel buttons; front panel LEDs blink 4 times when locking/unlocking. If the control lock is enabled and a button is pressed, front panel LEDs blink 3 times. *#controllock*

4.4.5. Entering Firmware Upgrade Mode

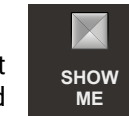

It may happen that the firmware upgrade process is not successful and the device cannot be switched to bootloader mode automatically. In this case, the device can be forced into firmware upgrade mode as follows:

Step 1. Make sure the transmitter is powered off.

Step 2. Press and keep pressed the **Show Me** button.

Step 3. Power on the transmitter while the **Show Me** button is being pressed. If the device is switched to firmware upgrade mode the LIVE LED is blinking quickly (less than 500 ms duty cycle). The other LEDs are off.

The procedure of firmware upgrade can be found in the [Firmware Upgrade](#) chapter.

4.5. Software Control Modes

User has more possibilities to control the device besides the front panel buttons. The following list contains the software control modes:

- **Lightware Device Controller (LDC)** - you can connect to the device via our control software using Ethernet or RS-232 interface and control or configure the device as you wish. For the details see the [Software Control - Lightware Device Controller](#) chapter.
- **LW2 protocol commands:** you can configure the device by using the reduced command set of LW2 protocol. For more details see the [LW2 Programmer's Reference](#) chapter.
- **LW3 protocol commands:** you can configure the device by using the full-range command set of LW3 protocol. For more details see the [LW3 Programmers' Reference](#) chapter.

5

Software Control - Lightware Device Controller

The device can be controlled by a computer through the Ethernet and RS-232 ports using Lightware Device Controller (LDC). The software can be installed on a Windows PC or macOS. The application and the User's manual can be downloaded from www.lightware.com.

- ▶ [INSTALL AND UPGRADE](#)
- ▶ [RUNNING THE LDC](#)
- ▶ [CONNECTING TO A DEVICE \(DEVICE DISCOVERY WINDOW\)](#)
- ▶ [CROSSPOINT MENU](#)
- ▶ [PORT PROPERTIES WINDOWS](#)
- ▶ [DIAGNOSTIC TOOLS](#)
- ▶ [EDID MENU](#)
- ▶ [CONTROL MENU](#)
- ▶ [EVENT MANAGER](#)
- ▶ [SETTINGS MENU](#)
- ▶ [CONFIGURATION CLONING \(BACKUP TAB\)](#)
- ▶ [ADVANCED VIEW WINDOW](#)
- ▶ [LW2 PROTOCOL DESCRIPTION](#)
- ▶ [GENERAL LW2 COMMANDS](#)

5.1. Install and Upgrade

INFO: After the installation, the Windows and the Mac application has the same look and functionality. This type of the installer is equal with the Normal install in case of Windows and results an updateable version with the same attributes.

Installation for Windows OS

Run the installer. If the User Account Control drops a pop-up message click **Yes**.

During the installation you will be prompted to select the type of the installation: **normal** and the **snapshot** install:

Normal install	Snapshot install
Available for Windows and macOS	Available for Windows
The installer can update only this instance	Cannot be updated
Only one updateable instance can exist for all users	More than one different version can be installed for all users

Comparison of installation types

ATTENTION! Using the Normal install as the default choice is highly recommended.

Installation for macOS

Mount the DMG file with double clicking on it and drag the LDC icon over the Applications icon to copy the program into the Applications folder. If you want to copy the LDC into another location just drag the icon over the desired folder.

Upgrading of LDC

Step 1. Run the application.

The **Device Discovery** window appears automatically and the program checks the available updates on Lightware's website and opens the update window if the LDC found updates.

The current and the update version number can be seen at the top of the window and they are shown in this window even with the snapshot install.

The **Update** window can also be opened by clicking the **About icon**  and the **Update** button.

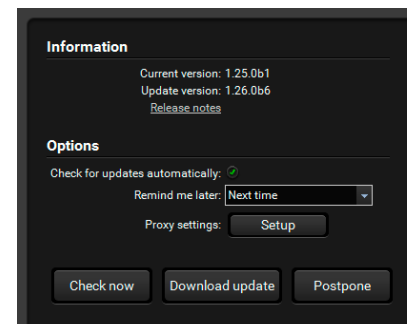

Step 2. Set the desired update setting in the **Options** section.

- If you do not want to check for the updates automatically, uncheck **the circle**, which contains the green tick.
- If you want to postpone the update, a reminder can be set with different delays from the **drop down list**.
- If the proxy settings traverse the update process, set the proper values then click the **OK** button.

Step 3. Click the **Download update** button to start the upgrading.

The updates can be checked manually by clicking the **Check now** button.

5.2. Running the LDC

The common way to start the software is double-click on the LDC icon. But the LDC can be run by command line parameters as follows:

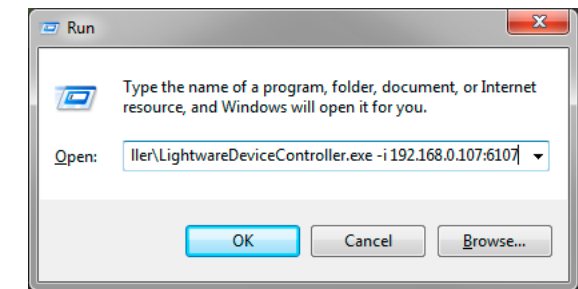

Connecting to a Device with Static IP Address

Format: LightwareDeviceController -i <IP_address>:<port>

Example: LightwareDeviceController -i 192.168.0.20:6107

The LDC is connected to a device with the indicated static IP address directly; the Device Discovery window is not displayed. When the port number is not set, the default port is used: 10001 (LW2 protocol). For LW3 devices use the **6107** port number.

Connecting to a Device via a Serial Port

Format: LightwareDeviceController -c <COM_port>:<Baud>

Example: LightwareDeviceController -c COM1:57600

The LDC is connected to a device with the indicated COM port directly; the Device Discovery window is not displayed. If no Baud rate is set the application will detect it automatically.

5.3. Connecting to a Device (Device Discovery Window)

There are three tabs for the different type of interfaces: Ethernet, Serial, and USB (in UMX-TPS-TX140K).

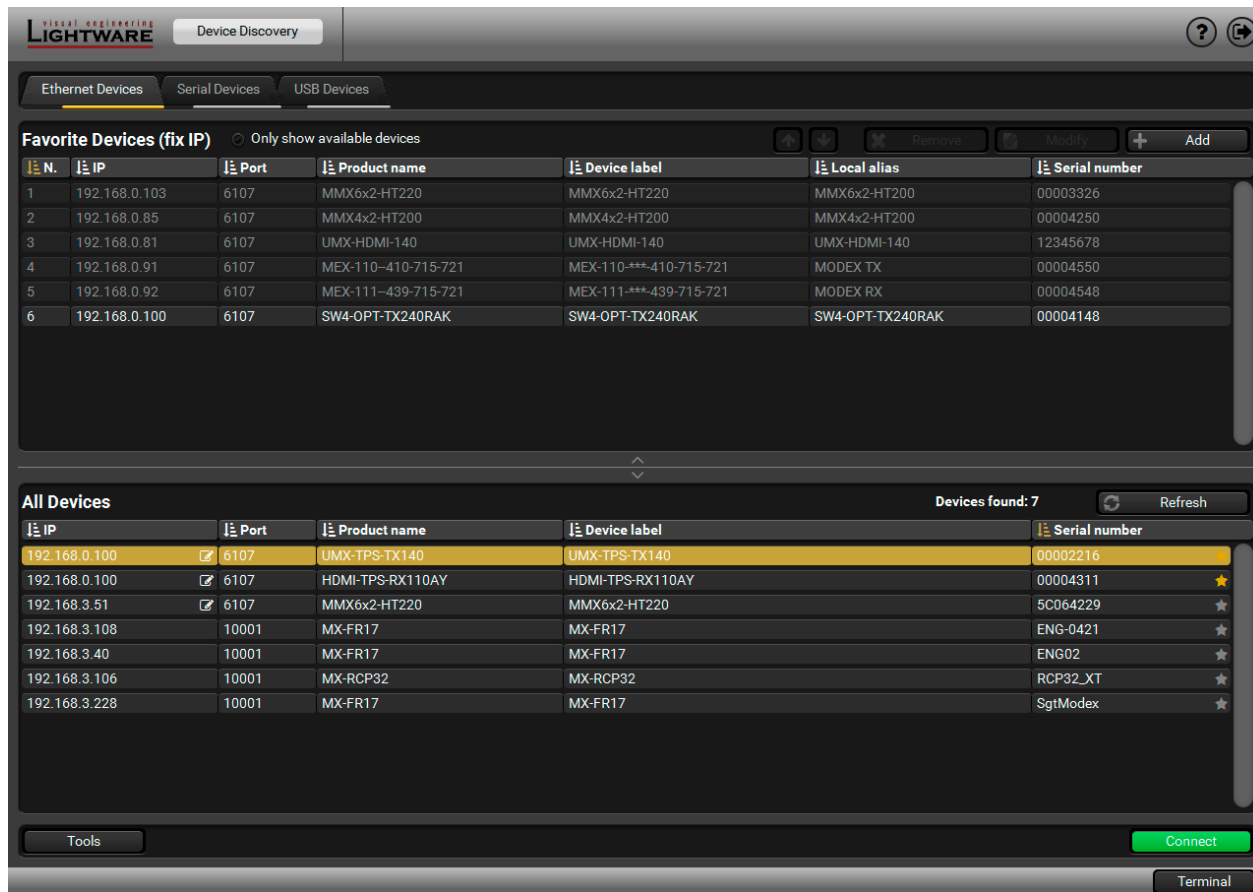

Device Discovery Window

Establishing the Connection

Select the unit from the discovered Ethernet devices (see the picture on the left); if the device is connected via the RS-232 port click on the **Query** button next to the desired serial port to display the device's name and serial number (see the picture below). Double click on the device or select it and click on the green **Connect** button.

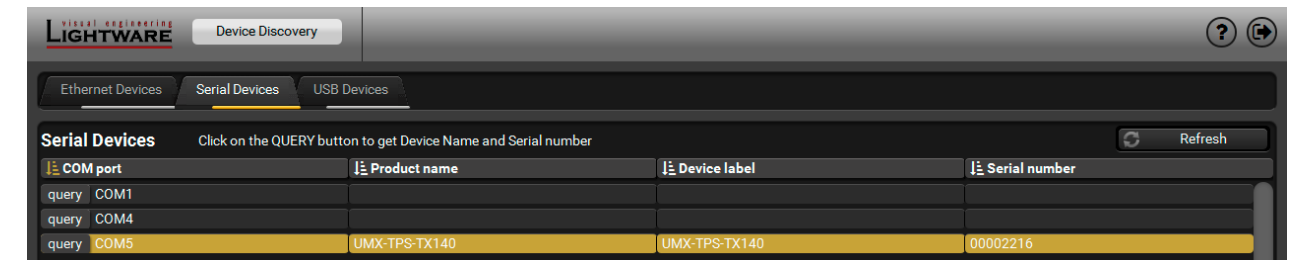

ATTENTION! Before the device is connected via the local RS-232 port, make sure that **Control mode** and **LW3 protocol** are set on the serial port.

The Ethernet tab consists of two lists:

- **Favorite Devices:** You can add any Lightware device that is connected via Ethernet and no need to browse all the available devices. Devices can be added by pressing the **Add** button or marking the desired device by the ★ symbol in the **All Devices** list.
- **All Devices:** The Lightware devices are listed which are available in the connected network.

Further Tools

The **Tools** menu contains the following options:

- **Log Viewer:** The tool can be used for reviewing log files which have been saved previously.
- **Create EDID:** This tool opens the Easy EDID Creator wizard which can be used for creating unique EDIDs in a few simple steps. Functionality is the same as the Easy EDID Creator.
- **Demo Mode:** This is a virtual MX-FR17 matrix router with full functionality built into the LDC. Functions and options are the same as a real MX-FR17 device.

The **Terminal** window is also available by pressing its button on the bottom.

IP Address Configuration

The IP settings of a device can be changed without establishing the connection to the LDC. If the feature is supported by the device an icon is displayed next to the IP address:

Press the icon to open the IP configuration window and set the necessary parameters then press the **Apply** button (or **Cancel** to discard and exit).

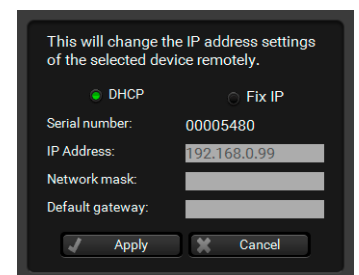

Identifying the Device

Clicking on the icon results the blinking of the status LEDs for 10 seconds. The feature helps to identify the device itself in the rack shelf.

5.4. Crosspoint Menu



- 1 **Main menu** The available menu items are displayed. The active one is showed with dark grey background color.
- 2 **Information ribbon** The label shows the device label which can be edited in the Settings menu - [Status](#) tab. Device discovery window can be displayed by clicking on this ribbon.
- 3 **Video input ports** Each tile represents a video input port. The tile below the port shows the current crosspoint setting; if the port is switched to the output, the color of the tile is white, otherwise grey. *#crosspoint #switch #testpattern*
- 4 **Audio input ports** Each tile represents an audio input port. The tile below the port shows current crosspoint setting; if the port is switched to the output, the color of the tile is white, otherwise grey. Dark grey means the audio port is not allowed to embed in the current video input port. *#audio #analogaudio*
- 5 **Advanced view** Displaying [Advanced View Window](#), showing the Terminal window and the LW3 protocol tree. *#nosyncscreen*
- 6 **Audio output** The audio output of the TPS out port. Clicking on the tile opens the [TPS Audio Output](#).
- 7 **Video output** The video output of the TPS out port. Clicking on the tile opens the [TPS Video Output](#).

Port Tiles #status

The colors of the port tiles and the displayed icons represent different states and information:

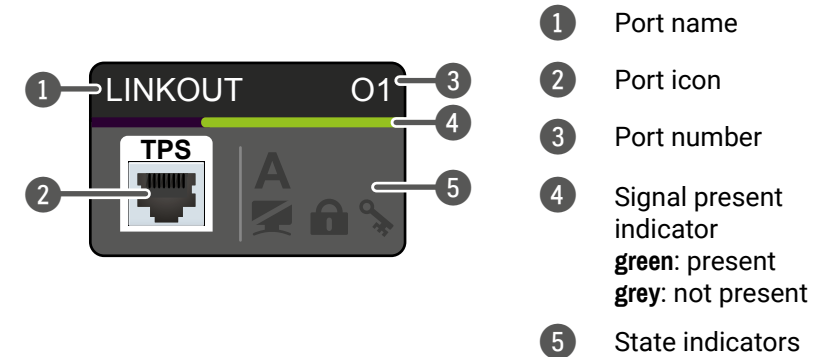

State Indicators

Following icons display different states of the port/signal:

Icon	Icon is grey	Icon is black	Icon is green
	Signal is not encrypted with HDCP	Signal is encrypted with HDCP	-
	Port is unmuted	Port is muted	-
	Port is unlocked	Port is locked	-
	Autoselect is disabled	-	Autoselect is enabled

5.5. Port Properties Windows

Clicking on the port tile opens the Port properties window. This section shows the available settings and status information by port types.

5.5.1. Analog Video Inputs

Port properties windows of VGA and DVI-A input ports provide similar settings and status information:

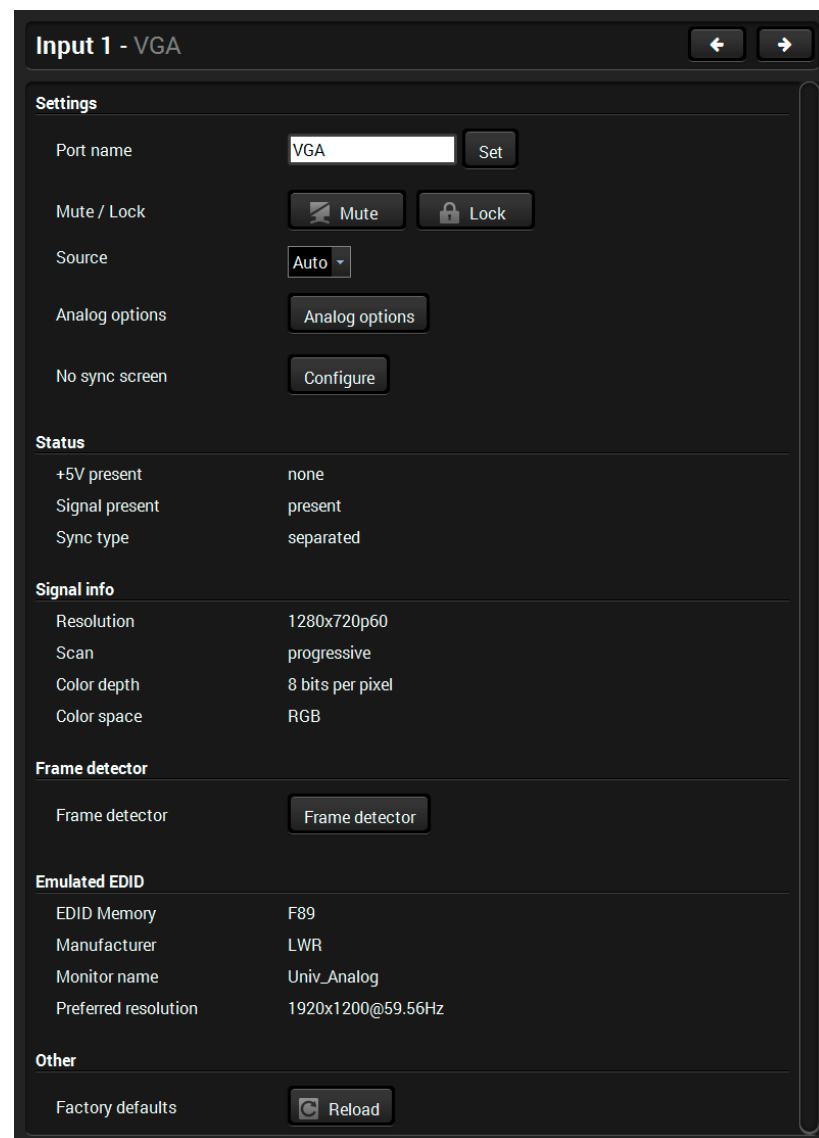

Port properties window of the VGA video input

Available settings: `#mute #unmute #lock #unlock #testpattern`

- Mute/unmute the port; `#nosyncscreen`
- Lock/unlock the port;
- Source: Auto / RGB / YUV;
- Analog options, see the details below;
- No sync screen: configuration settings of the [Test Pattern](#);
- [Frame Detector](#); `#framedetector`
- Reloading factory default settings for the selected port. `#factorydefault`

Analog Options

Analog video signals are digitized on the input. The timing parameters can be adjusted here if needed. Timing presets can be saved for each resolution separately. User has 32 user presets to store different timing data.

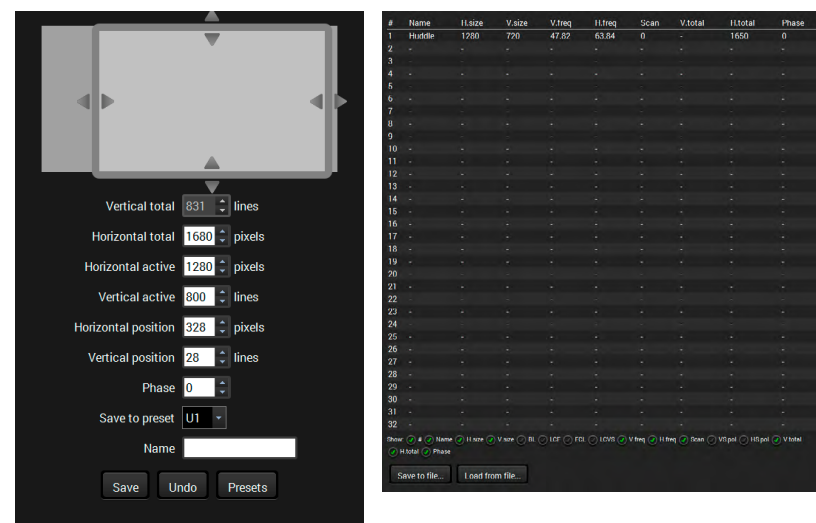

Analog options and Presets windows in LDC

5.5.2. Digital Video Inputs

Clicking on the HDMI, DisplayPort, or DVI-D input port icon results opening the Port properties window. The most important information and settings are available from the panel.

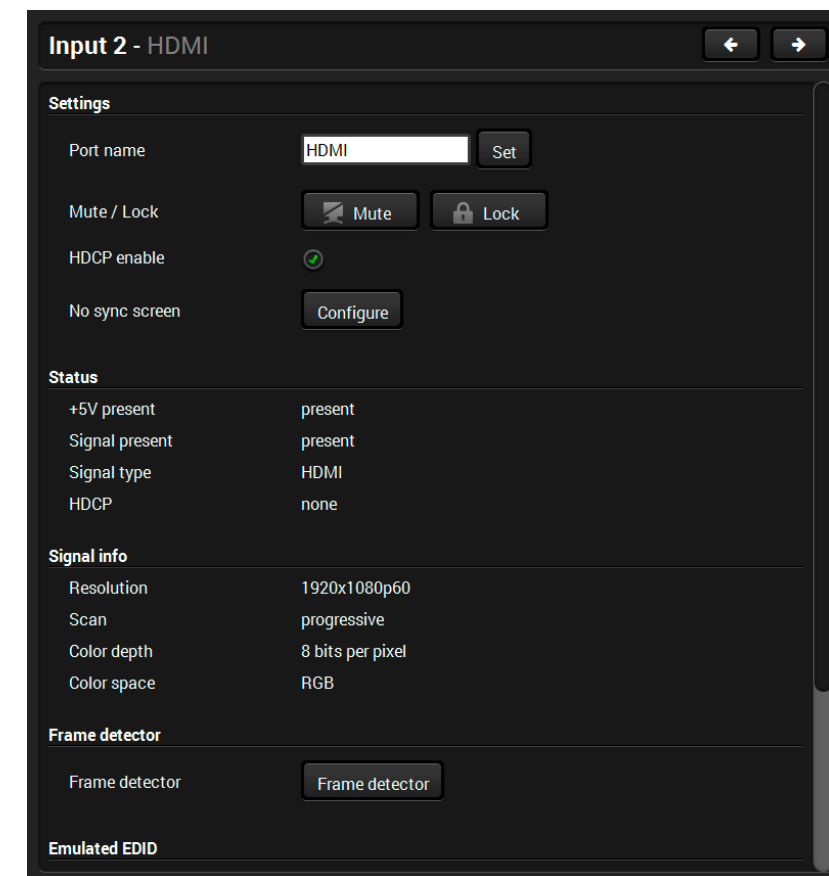

Port properties window of the HDMI video input

Available settings:

- Mute/unmute the port;
- Lock/unlock the port;
- HDCP setting (enable / disable);
- No sync screen: configuration settings of the [Test Pattern](#);
- [Frame Detector](#);
- Reloading factory default settings for the selected port.

5.5.3. CEC Command Sending

UMX-TPS-TX140-Plus, UMX-TPS-TX140K and WP-UMX-TPS-TX130-Plus-US models are able to send and receive Consumer Electronic Control (CEC) commands. This feature is for remote control of the source or sink device. CEC is a bi-directional communication via HDMI cable, in this case between the input port of the switcher and the source. *#cec*

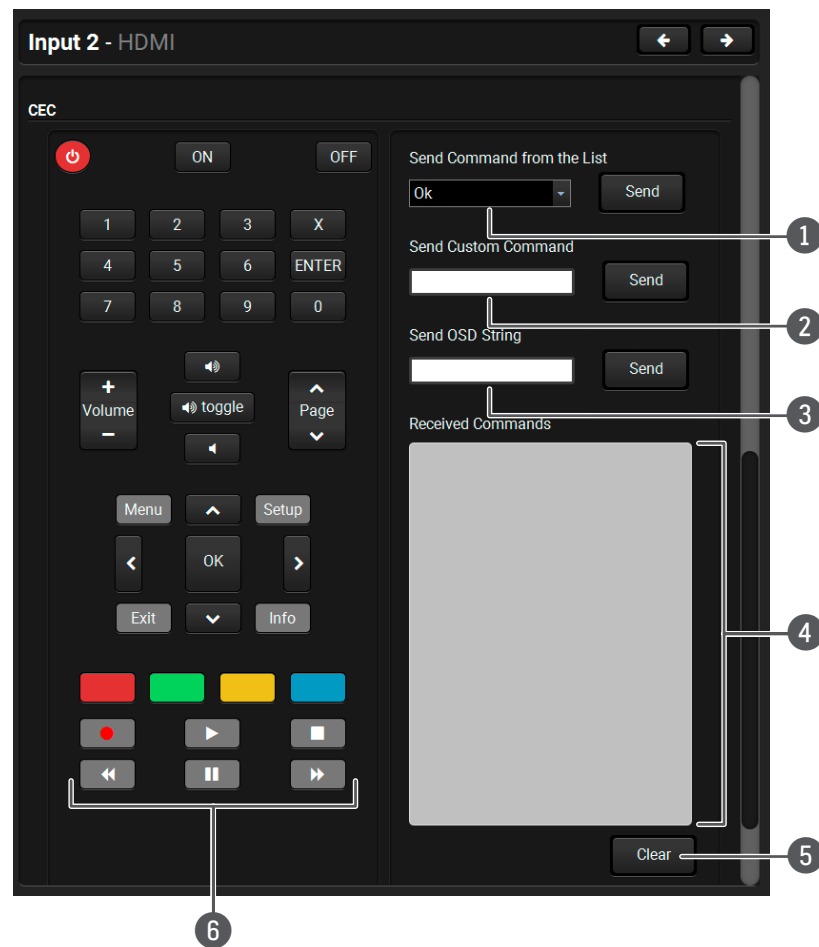

Layout of CEC panel on the HDMI input port

The CEC panel is available on the port properties window of the **HDMI input** and **TPS output** ports.

ATTENTION! It can occur that the third-party device can receive, but not execute the command because it is not supported by the product. Check the accepted commands in the documentation of the device.

INFO: The first 2x2 bytes of the CEC commands contains identification data of the source and destination address. When the port is input, it is always 04 (from TV to Playback device 1.), when the port is output, it is always 40 (from Playback device 1. to TV).

- 1 **Drop-down command list** This list contains the basic CEC commands, most of them are displayed on the graphical interface, too (on the left side). Click on the **Send** button to execute sending the command.
- 2 **Custom command textbox** The text field is for sending hexadecimal commands to the source. The maximum length of the message could be 30 characters (15 bytes). Click on the **Send** button to execute sending the command.
- 3 **OSD string textbox** A max. 14 character-long text can be shown on the sink device. The send OSD (On-screen display) command textbox is the input field of the string. Alphanumeric characters, glyphs and space are accepted. Click on the **Send** button to execute the command.
- 4 **Received Command box** Displays all the sent (in red) CEC commands and the received answers (in blue) with a timestamp.
Legend of the received message:
 - < [10:33:17] ACK
Answer for the acknowledged command.
 - < [10:35:01] NACK
Answer for the not acknowledged command.
 - < [10:33:17] IN PROGRESS
The command is in progress at the moment.
 - < [10:33:17] FAILED
Answer for other failure.
 - < [10:35:40] feature_abort_<*>
This is the most common answer from the third-party devices when the command is delivered, but the execution is refused. The cause of the refuse stands after 'feature_abort' expression.
- 5 **Clear button** Click on the **Clear** button to erase the content of the terminal window.
- 6 **CEC command button panel** This panel provides the quick and easy management of CEC commands. These buttons are pre-programmed with basic functions and sends commands towards the sink. The communication is displayed in the Received Command box. For the list of the commands see [Sending CEC Commands](#) section. Both the layout and functionality are similar to the design of a remote control.

ATTENTION! Make sure that the controlled unit is CEC-capable and this function is enabled.

5.5.4. TPS Video Output

Click on the output port to display its properties. The most important information and settings are available from the panel.

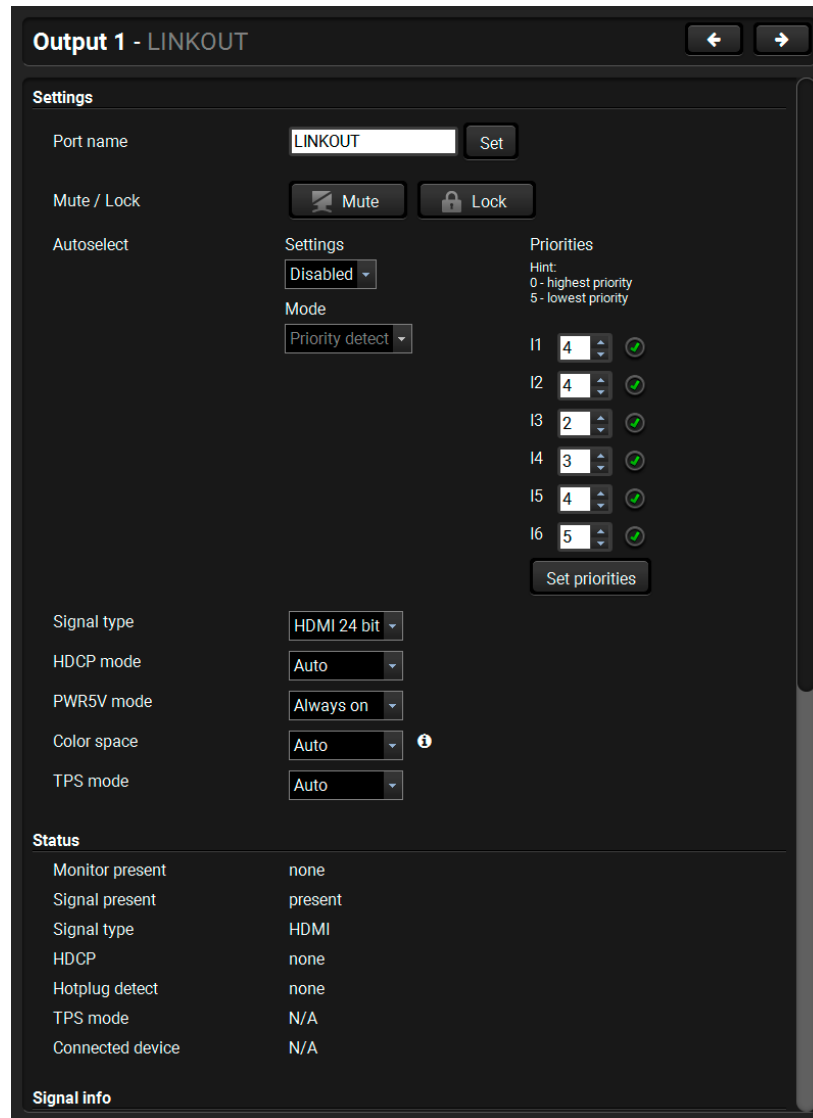

Port properties window of TPS video output

Available settings: `#mute #unmute #lock #unlock #testpattern`

- Mute/unmute the port; `#nosyncscreen`
- Lock/unlock the port;
- **Autoselect settings:** enable / disable, mode, and priorities. (See more details about Autoselect feature in [The Autoselect Feature](#) section);
- **Signal type:** Auto / DVI / HDMI 24 bit / HDMI 30 bit / HDMI 36 bit - The outgoing signal format can be selected by a drop-down menu;
- **HDCP mode:** Auto / Always - The transmitter forces the source sent the signal without encryption if the content allows when Auto mode is selected;
- **Power 5V mode:** Auto / Always on / Always off - The setting lets the source and the sink devices be connected – independently from the transmitted signal;
- **Color space:** Auto / RGB / YCbCr 4:4:4 / YCbCr 4:2:2 - The outgoing signal color space can be selected by a drop-down menu;

INFO: The color space conversion supports resolutions up to 1600×1200@60Hz. When the pixel clock frequency is above 170MHz, the conversion does not execute, and the original content will be transmitted.

- **TPS mode:** Auto / HDBaseT / Long reach / LPPF1 / LPPF2. See more information about TPS modes in the [TPS Interface](#) section.
- [Frame Detector](#);
- [Cable Diagnostics](#);
- [CEC Command Sending](#) (in UMX-TPS-TX140-Plus, UMX-TPS-TX140K and WP-UMX-TPS-TX130-Plus-US models)
- Reloading factory default settings for the selected port.

`#autoselect #mute #unmute #lock #unlock htcp #status #colorspace #tpsmode`

5.5.5. Analog Audio Inputs

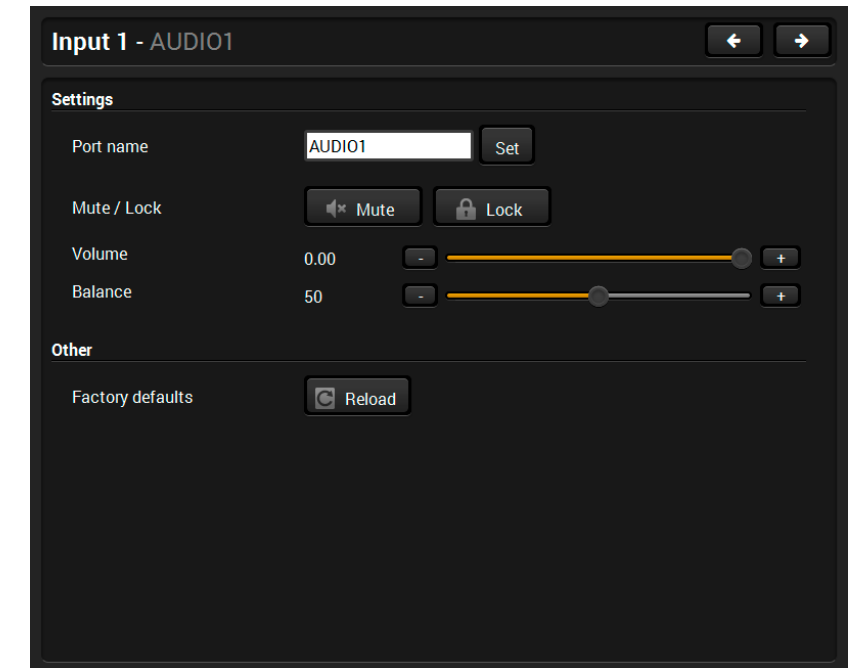

Port properties window of the AUDIO1 (Jack) input

Certain parameters of the analog audio input signal can be set as follows: `#analogaudio #audio`

- Mute/unmute the port;
- Lock/unlock the port;
- Volume: from 0 dB to -52 dB (step 0.25 dB), from -54 dB to -66 dB (step 2 dB); -69 dB; -72 dB; -78 dB (default is 0 dB)
- Balance: from 0 to 100, step 1 (default is 50 = center)
- Reloading factory default settings for the selected port.

5.5.6. Digital Audio Inputs

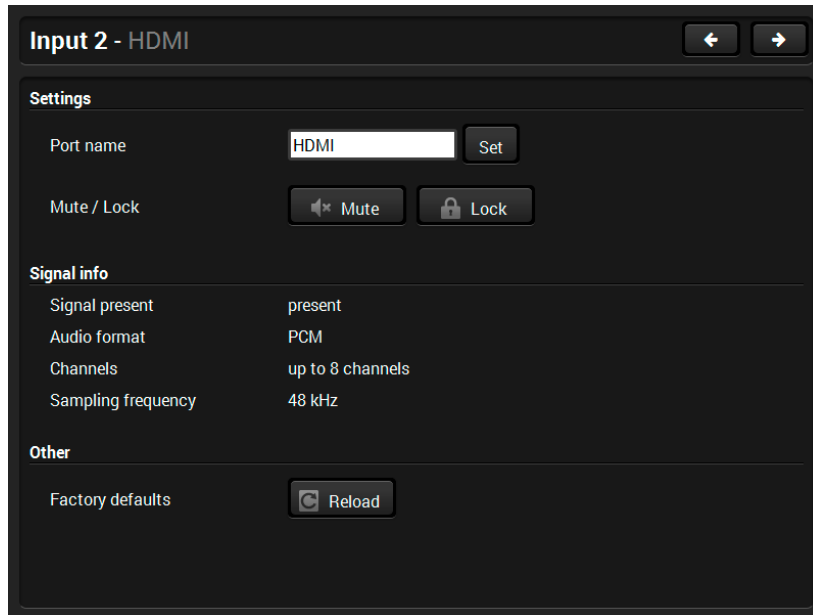

Port properties window of HDMI audio input

Certain parameters of the embedded audio input signal can be set as follows:

- Mute/unmute the port;
- Lock/unlock the port;
- Reloading factory default settings for the selected port.

#mute #unmute #lock #unlock #audio

5.5.7. TPS Audio Output

Certain parameters of the digital audio output signal can be set as follows:

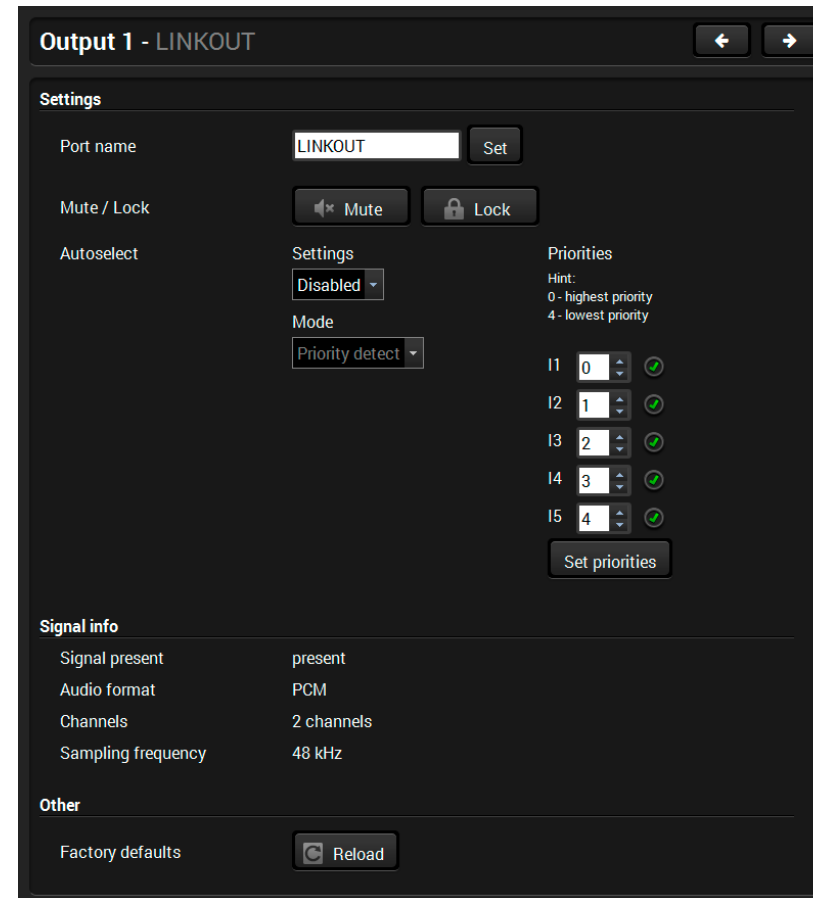

Port properties window of the TPS audio output

Available settings:

- Mute/unmute the port;
- Lock/unlock the port;
- **Autoselect settings:** enable / disable, mode, and priorities. (See more details about Autoselect feature in [The Autoselect Feature](#) section);
- Reloading factory default settings for the selected port.

5.6. Diagnostic Tools

5.6.1. Cable Diagnostics

The cable diagnostics is a useful tool to determine any cable related issues in case of TPS connection. The estimated cable length and the quality of the link are measured periodically and the diagnostic window shows the values in real-time. If the green bars hit the first line in the middle they turn into red. It means the number of the errors – during the extension – is higher than recommended. The link might be alive but recovering of the received data is not guaranteed.

INFO: Each bar represents a differential line in the CATx cable. The inappropriate termination of the cable usually causes high error rates. Check the cable terminations or change the cable.

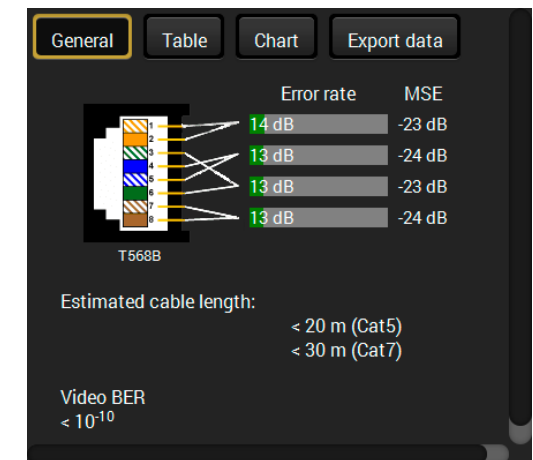

Reference Values #cablediagnostics

Value	Explanation
10 ⁻¹⁰ -10 ⁻⁹	Excellent image quality
10 ⁻⁸	Minor error, not recognizable by eyes
10 ⁻⁷	Sometimes recognizable flash on a special test pattern
10 ⁻⁶	Small noise can be seen
10 ⁻⁵	Easy to recognize image error
10 ⁻⁴	Bad image quality

Above displayed “Video BER < 10⁻¹⁰” value means that on average there is 1 bad pixel after 10¹⁰ pixels, which means the number of the bit errors is about 1 pixel in every 80 seconds.

INFO: You can find more details about maximum twisted pair cable distances in the [Maximum Extension Distances](#) section.

Table and Chart Views #cablediagnostics

Cable diagnostics can be displayed in advanced modes as well. Two ways are available: **table view** and **chart view**. Data can be exported to a file on clicking on the **Export data** button.

Date	MSE #1	MSE #2	MSE #3	MSE #4	Error rate #1	Error rate #2	Error rate #3	Error rate #4	Cable length
2016-11-12 09:57:23	-24	-22	-22	-22	28	52	32	34	< 20
2016-11-12 09:57:24	-24	-22	-22	-22	28	52	32	34	< 20
2016-11-12 09:57:25	-24	-22	-23	-23	28	46	30	34	< 20
2016-11-12 09:57:26	-24	-22	-22	-22	26	44	30	36	< 20
2016-11-12 09:57:27	-24	-22	-22	-22	26	44	30	36	< 20
2016-11-12 09:57:28	-24	-22	-23	-22	26	46	32	38	< 20
2016-11-12 09:57:29	-24	-22	-23	-22	26	46	32	38	< 20
2016-11-12 09:57:30	-24	-22	-23	-22	26	46	32	38	< 20

Table view of cable diagnostics

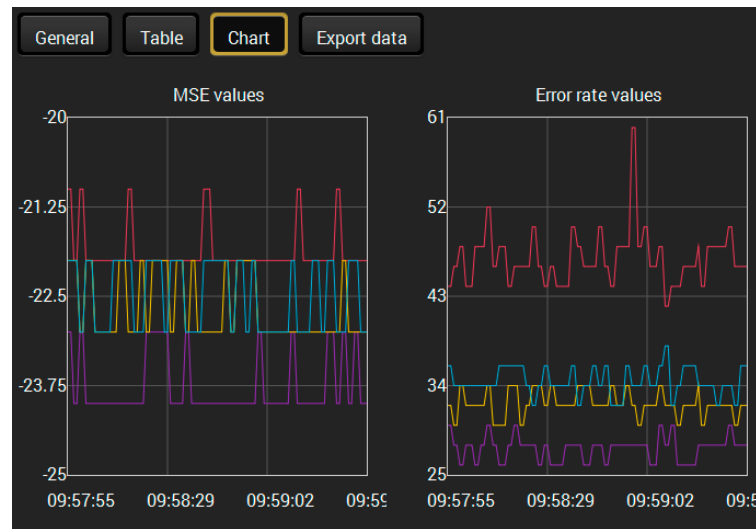

Chart view of cable diagnostics

5.6.2. Test Pattern

The port generates an image which can be displayed when there is no incoming signal on the port. Each port can have individual settings which can be set by clicking on the **Configure** button. #testpattern

Input 6 - TESTPATTERN

Settings

Port name: TESTPATTERN [Set]

Mute / Lock: [Mute] [Lock]

Test pattern: [Configure]

Signal info

Resolution: 640x480p60

Scan: progressive

Color depth: 8 bits per pixel

Color space: RGB

Frame detector

Frame detector: [Frame detector]

Other

Factory defaults: [Reload]

Port properties window of the Test pattern input

Test Pattern Configuration on Testpattern Port (I6)

Resolution: 640x480p

Color: [Color palette]

#108020

Resolution: Set the desired image resolution from the drop-down menu.

Color: Click on the desired color or use the sliders and press the **Set color** button to store.

Test Pattern Configuration on Video Input Ports

Mode: Auto

Resolution: 640x480p

Color: [Color palette]

#7F7F7F

Mode: **Auto:** No sync screen signal is sent when there is no incoming signal.

Always on: No sync screen signal is sent always, independently from the incoming signal.

Always off: No signal is sent when there is no incoming signal.

Resolution: Set the desired image resolution from the drop-down menu.

Color: Click on the desired color or use the sliders and press the **Set color** button to store.

5.6.3. Frame Detector

The ports can show detailed information about the signal like full size and active video resolution. This feature is a good troubleshooter if compatibility problems occur during system installation. To access this function, open the port properties window and click on **Frame detector** button.

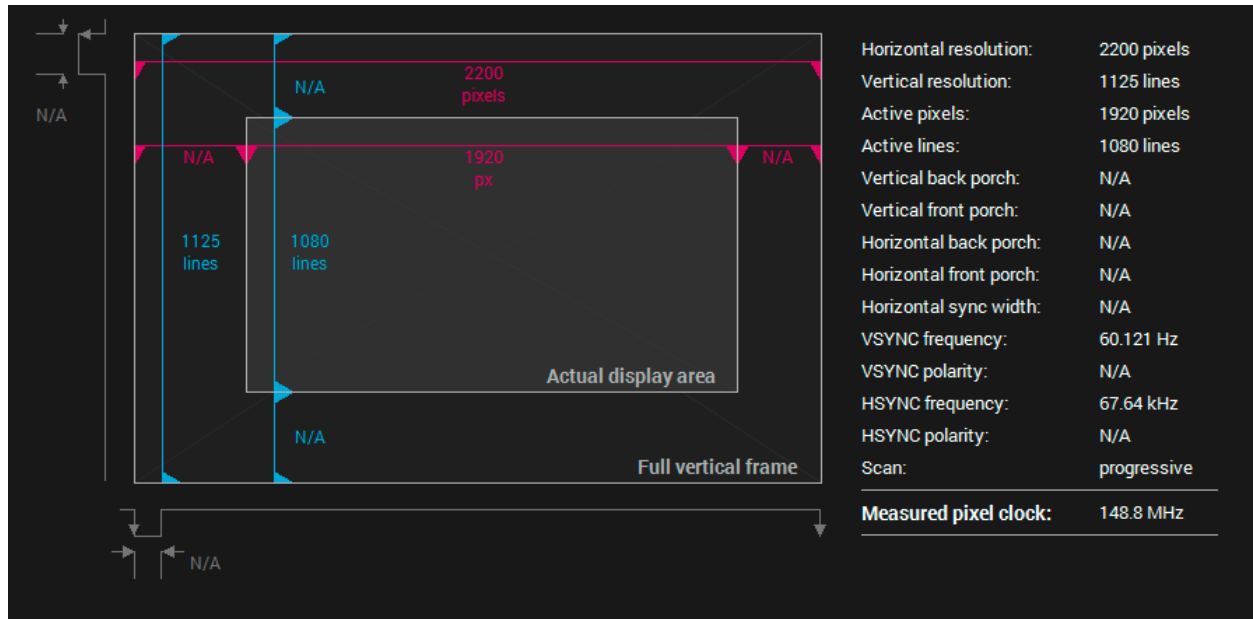

Frame detector window

Lightware's Frame Detector function works like a signal analyzer and makes possible to determine the exact video format that is present on the port, thus helps to identify many problems. E.g. actual timing parameters may differ from the expected and this may cause some displays to drop the picture. #framedetector

Frame Detector measures detailed timings on the video signals just like a built-in oscilloscope, but it is much more easy to use. Actual display area shows the active video size (light grey). Dark grey area of the full frame is the blanking interval which can contain the info frames and embedded audio data for HDMI signals. Shown values are measured actually on the signal and not retrieved only from the HDMI info frames.

5.7. EDID Menu

Advanced EDID Management can be accessed by selecting the EDID menu. There are two panels: left one contains Source EDIDs, right one contains Destination places where the EDIDs can be emulated or copied.

The screenshot shows the EDID menu with two panels: 'Factory' and 'User'. The 'User' panel is active, showing a list of EDIDs with columns for memory address, manual ID, resolution, audio, and monitor name. The 'Emulated' panel shows a similar list for emulation destinations.

Mem...	Manu...	Resolution	Audio	Monitor Name
F1	LWR	640x480@60.00Hz	N/A	D640x480p60
F2	LWR	848x480@60.00Hz	N/A	D848x480p60
F3	LWR	800x600@60.32Hz	N/A	D800x600p60
F4	LWR	1024x768@60.00Hz	N/A	D1024x768p60
F5	LWR	1280x768@50.00Hz	N/A	D1280x768p50
F6	LWR	1280x768@59.94Hz	N/A	D1280x768p60
F7	LWR	1280x768@75.00Hz	N/A	D1280x768p75
F8	LWR	1360x768@60.02Hz	N/A	D1360x768p60
F9	LWR	1280x1024@50.00Hz	N/A	D1280x1024p50
F10	LWR	1280x1024@60.02Hz	N/A	D1280x1024p60
F11	LWR	1280x1024@75.02Hz	N/A	D1280x1024p75
F12	LWR	1400x1050@50.00Hz	N/A	D1400x1050p50
F13	LWR	1400x1050@60.00Hz	N/A	D1400x1050p60
F14	LWR	1400x1050@75.00Hz	N/A	D1400x1050p75
F15	LWR	1680x1050@60.00Hz	N/A	D1680x1050p60
F16	LWR	1920x1080@50.00Hz	N/A	D1920x1080p50
F17	LWR	1920x1080@60.00Hz	N/A	D1920x1080p60
F18	LWR	2048x1080@50.00Hz	N/A	D2048x1080p50
F19	LWR	2048x1080@60.00Hz	N/A	D2048x1080p60
F20	LWR	1600x1200@50.00Hz	N/A	D1600x1200p50
F21	LWR	1600x1200@60.00Hz	N/A	D1600x1200p60
F22	LWR	1920x1200@50.00Hz	N/A	D1920x1200p50

EDID menu

Control Buttons

- Export: Exporting an EDID (save to a file)
- Import: Importing an EDID (load from a file)
- Info: Display EDID Summary window
- Edit: Opening Advanced EDID Editor with the selected EDID
- Create: Opening Easy EDID Creator
- Transfer button: executing EDID emulation or copying
- Delete selected: Deleting EDID (from User memory)
- Select all: Selecting all memory places in the right panel
- Select none: Selecting none of the memory places in the right panel

#edid

5.7.1. EDID Operations

Changing Emulated EDID #edid

- Step 1.** Choose the desired **EDID list** on the source panel and select an **EDID**. 
- Step 2.** Press the **Emulated** button on the top of the Destination panel.
- Step 3.** Select the desired **port** on the right panel (one or more ports can be selected); the EDID(s) will be highlighted with a yellow cursor.
- Step 4.** Press the **Transfer** button to change the emulated EDID.

Learning an EDID

The process is the same as changing the emulated EDID; the only difference is the Destination panel: press the **User** button. Thus, one or more EDIDs can be copied into the user memory either from the factory memory or from a connected sink (Dynamic).

Exporting an EDID

ATTENTION! This function is working on Windows and macOS operating systems and under Firefox or Chrome web browsers only.

Source EDID can be downloaded as a file (*.bin, *.dat or *.edid) to the computer.

- Step 1.** Select the desired **EDID** from the Source panel (line will be highlighted with yellow). 
- Step 2.** Press the **Export** button to open the dialog box and save the file to the computer.

Importing an EDID

Previously saved EDID (*.bin, *.dat or *.edid file) can be uploaded to the user memory:

- Step 1.** Press the **User** button on the top of the Source panel and select a **memory** slot. 
- Step 2.** Press the **Import** button below the Source panel.
- Step 3.** Browse the file in the opening window then press the **Open** button. Browsed EDID is imported into the selected User memory.

ATTENTION! The imported EDID overwrites the selected memory place even if it is not empty.

Deleting EDID(s)

The EDID(s) from User memory can be deleted as follows: 

- Step 1.** Press **User** button on the top of the Destination panel.
- Step 2.** Select the desired **memory** slot(s); one or more can be selected (“Select All” and “Select None” buttons can be used). The EDID(s) will be highlighted with yellow.
- Step 3.** Press the **Delete selected** button to delete the EDID(s).

5.7.2. EDID Summary Window

Select an EDID from Source panel and press **Info** button to display EDID summary. 

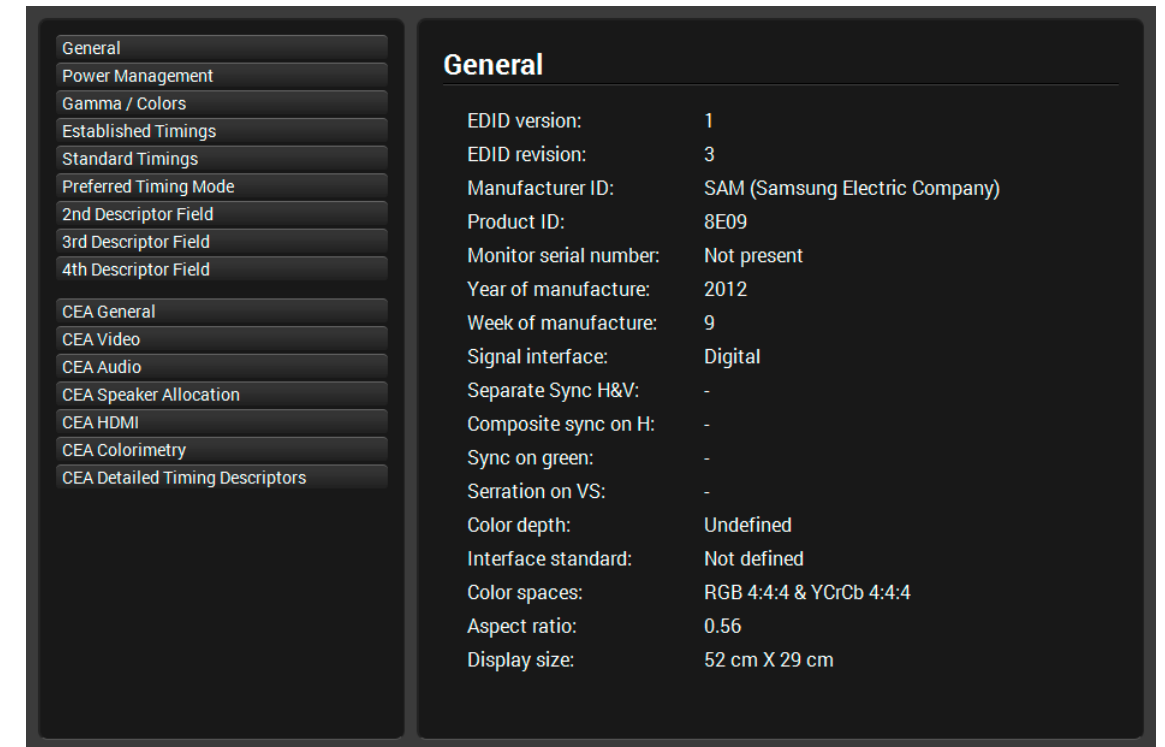

General	
EDID version:	1
EDID revision:	3
Manufacturer ID:	SAM (Samsung Electric Company)
Product ID:	8E09
Monitor serial number:	Not present
Year of manufacture:	2012
Week of manufacture:	9
Signal interface:	Digital
Separate Sync H&V:	-
Composite sync on H:	-
Sync on green:	-
Serration on VS:	-
Color depth:	Undefined
Interface standard:	Not defined
Color spaces:	RGB 4:4:4 & YCrCb 4:4:4
Aspect ratio:	0.56
Display size:	52 cm X 29 cm

EDID summary window

5.7.3. Editing an EDID

Select an EDID from Source panel and press Edit button to display Advanced EDID Editor window. The editor can read and write all descriptors, which are defined in the standards, including the additional CEA extensions. Any EDID from the device's memory or a saved EDID file can be loaded into the editor. The software resolves the raw EDID and displays it as readable information to the user. #edid

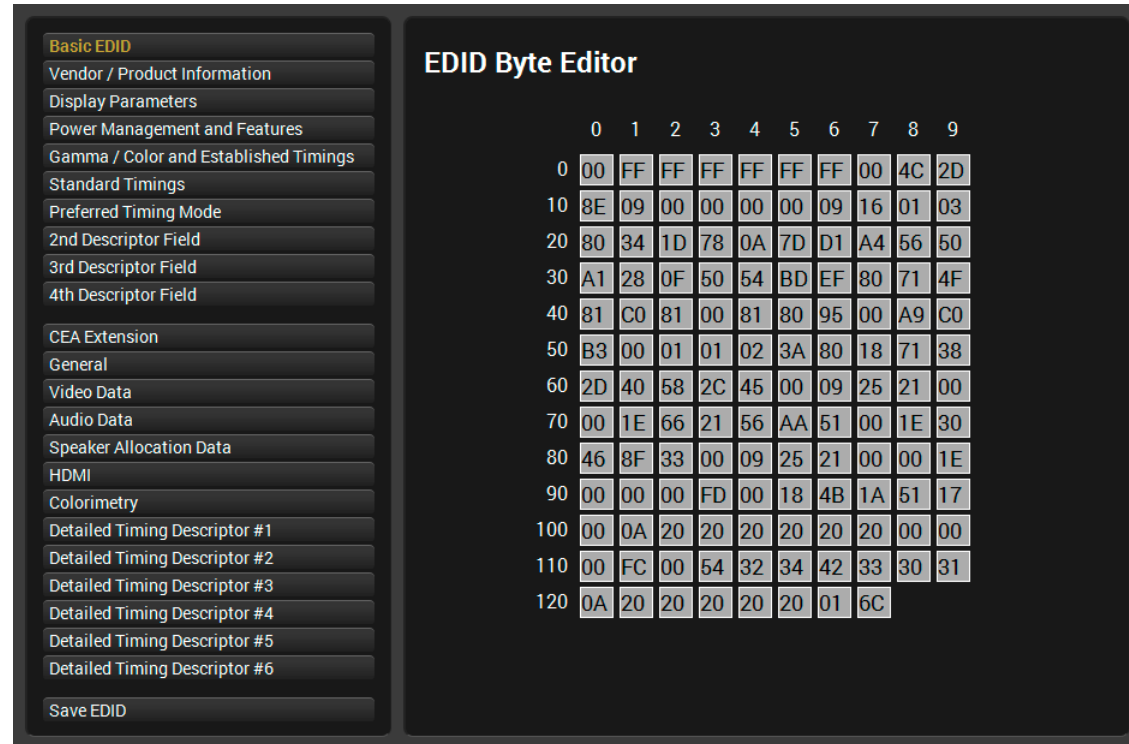

EDID Editor window

5.7.4. Creating an EDID - Easy EDID Creator

Since above mentioned Advanced EDID Editor needs more complex knowledge about EDID, Lightware introduced a wizard-like interface for fast and easy EDID creation. With Easy EDID Creator it is possible to create custom EDIDs in four simple steps. By clicking on the Create button below Source panel, Easy EDID Creator is opened in a new window.

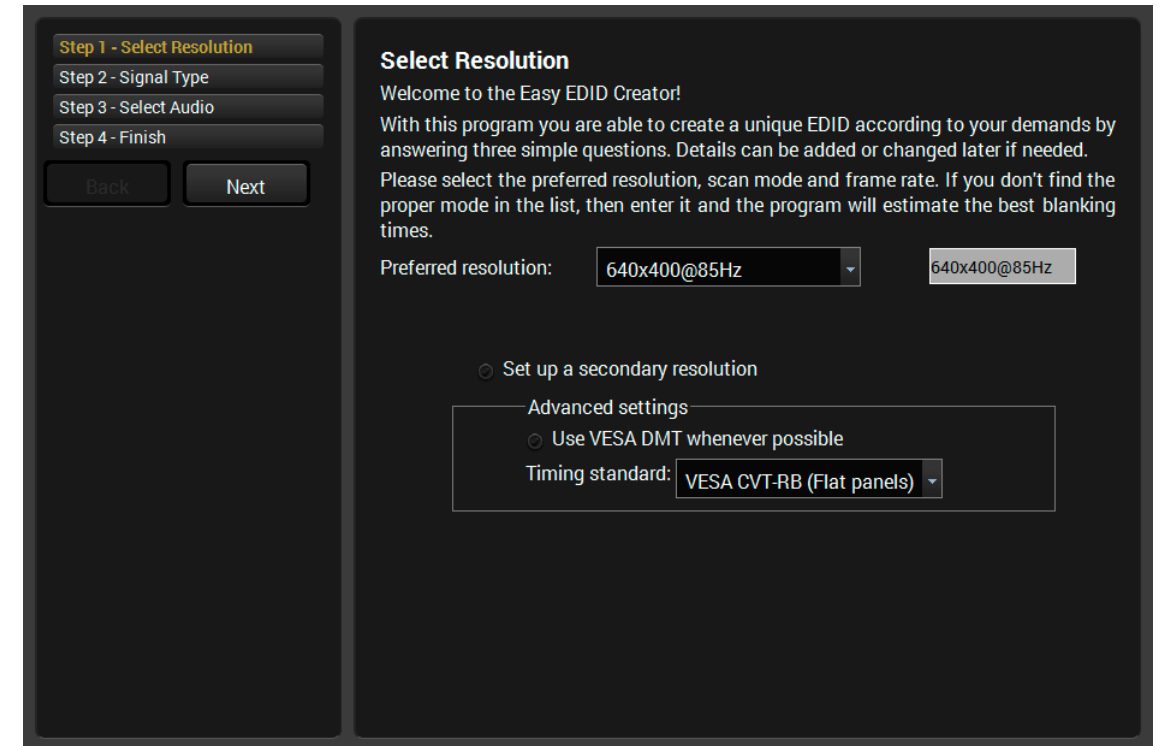

EDID Creator Window

5.8. Control Menu

5.8.1. RS-232 Tab

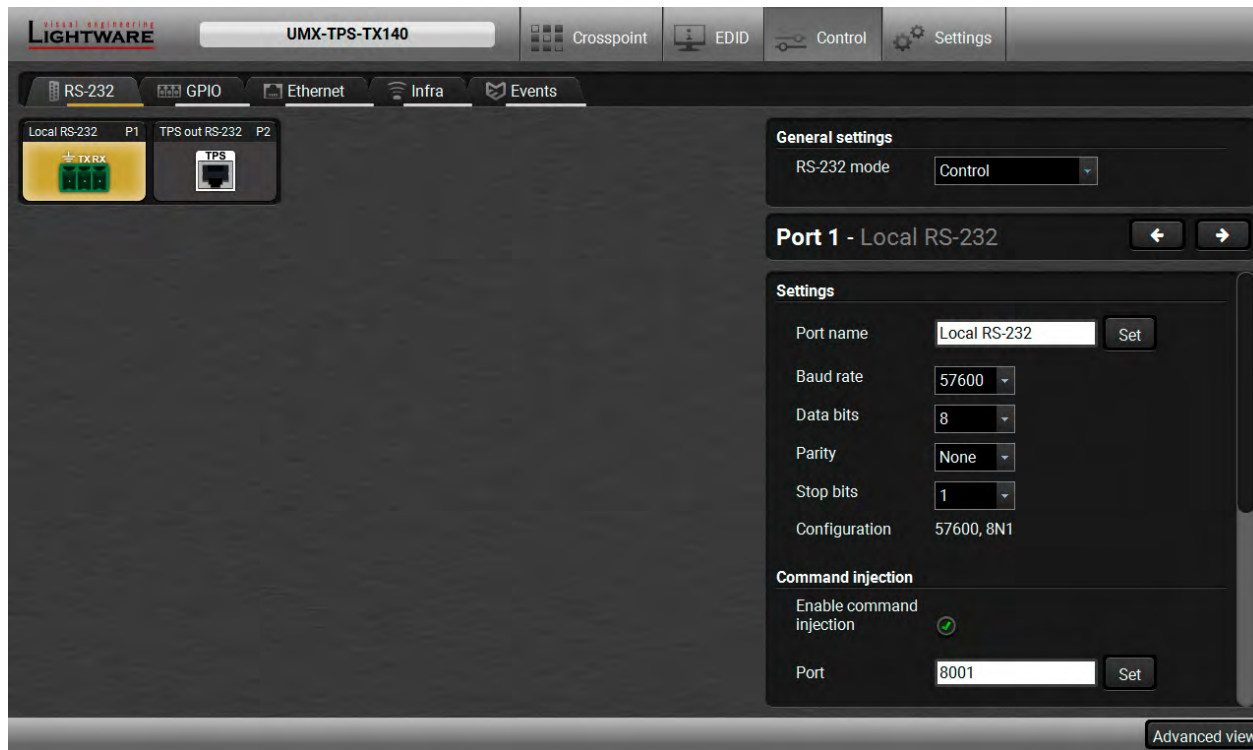

RS-232 tab in Control menu

The following settings and functions are available on the **local** and **TPS link** RS-232 port:

- **RS-232 mode:** Control, Pass-through, and Command Injection (for more details about serial interface modes see the [Technical Background](#) section);
- Baud rate: 4800, 7200, 9600, 14400, 19200, 38400, 57600, 115200;
- Data bits: 8 or 9;
- Parity: None, Odd, or Even;
- Stop bits: 1, 1.5, or 2;
- Command injection: enable or disable;
- Command injection port number;
- Control protocol: LW2 or LW3;
- Message sending via serial port;
- Reloading factory defaults (see factory default settings in the [Factory Default Settings](#) section).

ATTENTION! The RS-232 **Operation mode** is mirrored on the Local and TPS out serial port. The other settings can be adjusted separately on the two ports. `#rs232 #rs-232 #serial #commandinjection`

5.8.2. Message Recognizer

Difference: This feature is available in UMX-TPS-TX140-Plus, UMX-TPS-TX140K and WP-UMX-TPS-TX130-US models.

The device can analyze and store the received serial data. For more information see the [RS-232 Recognizer](#) section.

Put a tick to **Enable message recognizer on this port** to switch the recognizer on.

Delimiter sequence text box is for set the delimiter string in hex format. When this string is detected in the incoming serial data, the device saves the RS-232 message data from the first bit, until the delimiter (or the data between the two delimiters).

INFO: 0D0A is the factory default value, this is the hexadecimal code of Carriage Return and Line Feed. LW3 protocol commands ended with this formula, so the default value support the recognition of the LW3 commands and the stored changes automatically.

If the **Timeout** is enabled and set, the received data is saved when the timeout is elapsed after the last received message.

In **Received messages** box shows the last received and stored message in Text (RECOGNIZER.Rx), Hex (RECOGNIZER.RxHex), and Hash (RECOGNIZER.Hash) format. The Hex and Hash contains the delimiter.

Press the **Clear** button to erase this storage.

Clicking on **Reload** restores the [Factory Default Settings](#) of the recognizer.

ATTENTION! The Message recognizer settings are mirrored on the Local and TPS out serial port.

INFO: Message recognizer operates independently of the RS-232 mode.

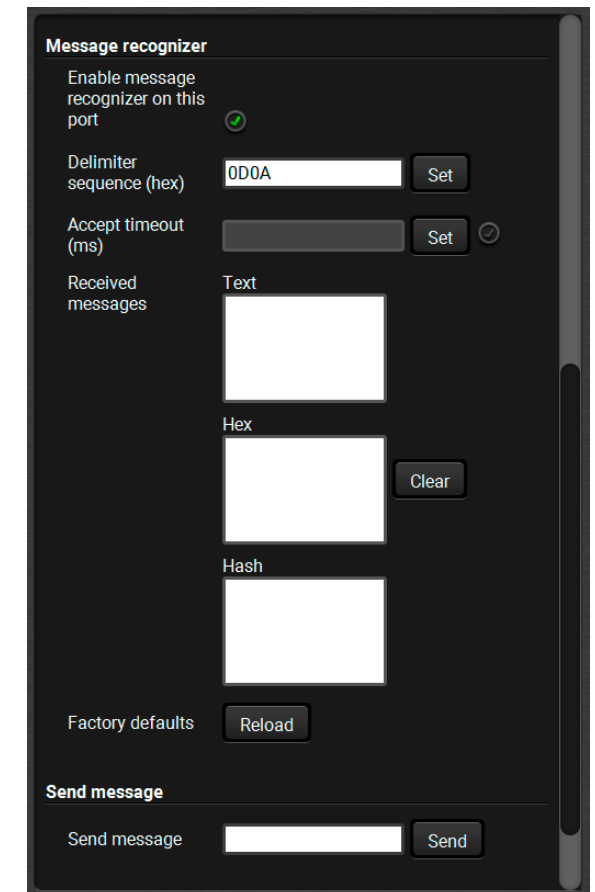

Configuration Example for the Message Recognizer

The detailed description below shows how to configure the message recognizer in [RS-232 Recognizer Example](#).

When the UMX-TPS-TX140-Plus has an active video signal, the switcher login the VC codec automatically. The signal presence triggers a bi-directional communication with the VC codec via RS-232:

Step 1. Turn on the recognizer: Enable it on the P1 serial port.

Step 2. Set the delimiter (in hex format). In this case, the delimiter character is ':', which is '3a' in hex format. When the delimiter string is detected in the incoming serial data, the serial message is stored in string (in Rx and ActiveRx property), hex (in RxHex and ActiveHex property) and hash (in Hash and ActiveHash property) format. These stored content can be set as a condition in the event manager.

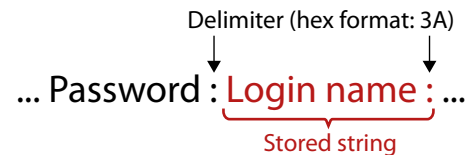

INFO: The stored content is the incoming data which arrives **before** the delimiter or **between** the two delimiters.

Step 3. Set the Active timeout 100. This property is responsible for erasing the temporary storage (ActiveRx, ActiveRxHex, ActiveHash) after the elapsing time. In the below example, it can be seen how does the recognizer properties change during the communication:

▶ UMX-TPS-TX140-Plus: **PING**

Rx	RxHex	Hash	ActiveRx	ActiveRxHex	ActiveHash

◀ VC codec: **Login:**

Rx	RxHex	Hash	ActiveRx	ActiveRxHex	ActiveHash
Login:	4C6F67696E3A	2D8A5E38	Login:	4C6F67696E3A	2D8A5E38

▶ UMX-TPS-TX140-Plus: **Admin**

Active timeout is elapsed, so the values of the Active- prefixed properties are deleted.

Rx	RxHex	Hash	ActiveRx	ActiveRxHex	ActiveHash
Login:	4C6F67696E3A	2D8A5E38			

◀ VC codec: **Password:**

Rx	RxHex	Hash	ActiveRx	ActiveRxHex	ActiveHash
Password:	50617373776F72643A	79059B26	Password:	50617373776F72643A	79059B26

▶ UMX-TPS-TX140-Plus: **Admin**

Active timeout is elapsed, so the values of the Active- prefixed properties are deleted.

Rx	RxHex	Hash	ActiveRx	ActiveRxHex	ActiveHash
Password:	50617373776F72643A	79059B26			

5.8.3. GPIO Tab

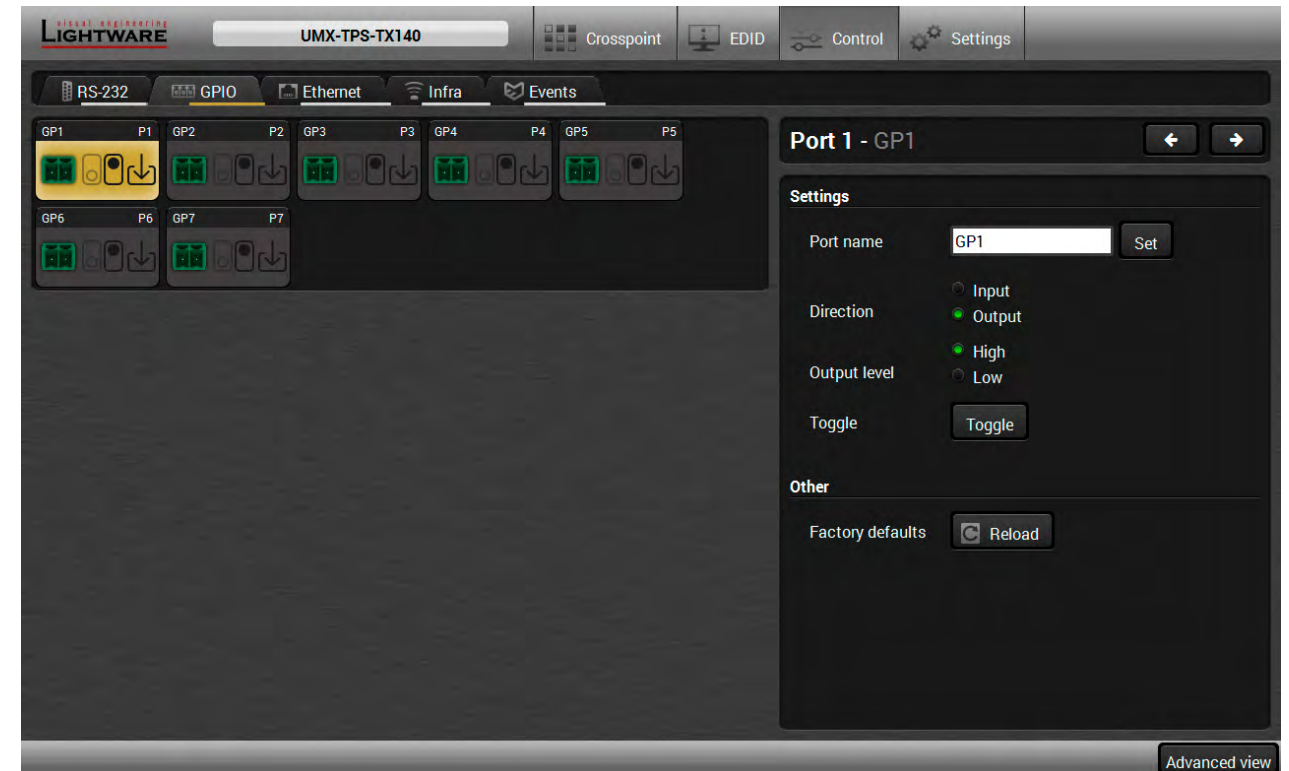

GPIO tab in Control menu

The GPIO port has 7 pins, which operate at TTL digital signal levels and can be controlled by LDC or protocol commands. Select a GPIO pin and under the Port settings section; the settings (pin direction and input level) are displayed on the port tiles as well: *#gpio*

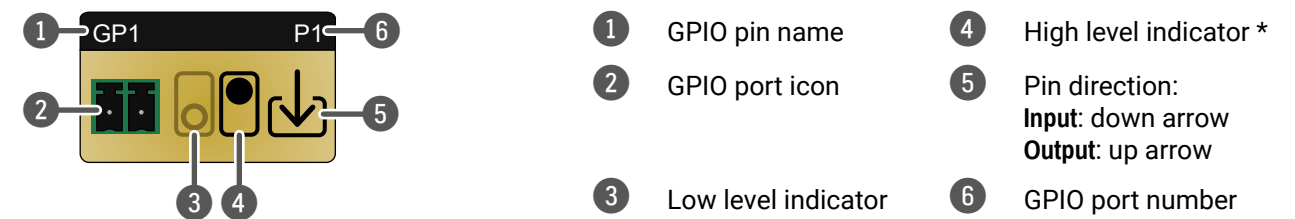

* Highlighted with black means the current setting.

INFO: Output level can be set only in case of setting the pin direction to Output. In case of input direction the output level setting and the Toggle button is not available.

For more details about GPIO interface see the [GPIO Interface](#) section.

5.8.4. Ethernet

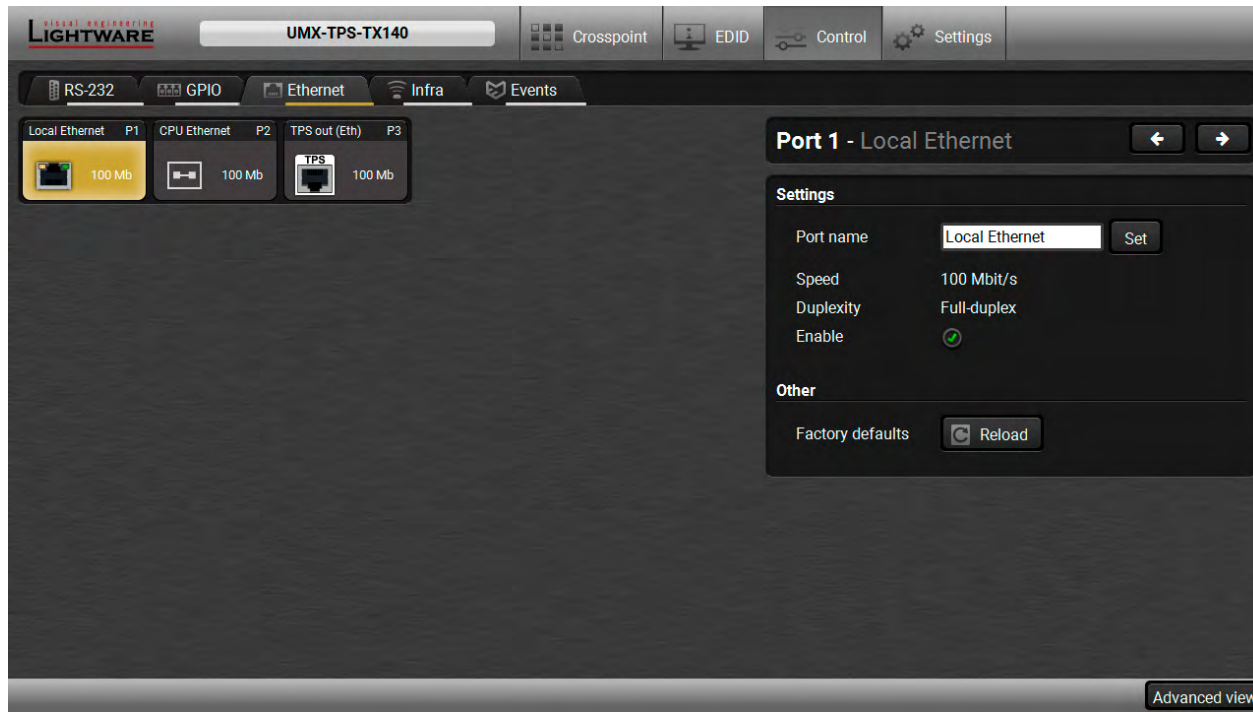

Ethernet tab in Control menu

Two ports are displayed in the Ethernet settings: Local, CPU, and TPS. You can check the status of the Ethernet line by each ports: the speed and the duplexity of the connection.

The following settings are available for the local port:

- Enable / disable the port;
- Reloading factory defaults.

ATTENTION! If the Ethernet port is set to disabled, this may break the connection with the device.

INFO: CPU Ethernet port cannot be disabled.

5.8.5. Infra Tab

ATTENTION! The device has no built-in Infrared receiver and transmitter. For the complete usage attach an IR emitter unit to the IR OUT and an IR detector unit to the IR IN connectors.

Infra-Red (IR) receiver and transmitter options can be found on this tab. There are three submenus are available under it: **IR codes**, **Ports**, and **Clear all IR codes**.

IR Codes

User can set the name of the IR code, the fingerprint (hash), and the repeat timeout in ms, as well as actions can be ordered to each IR codes.

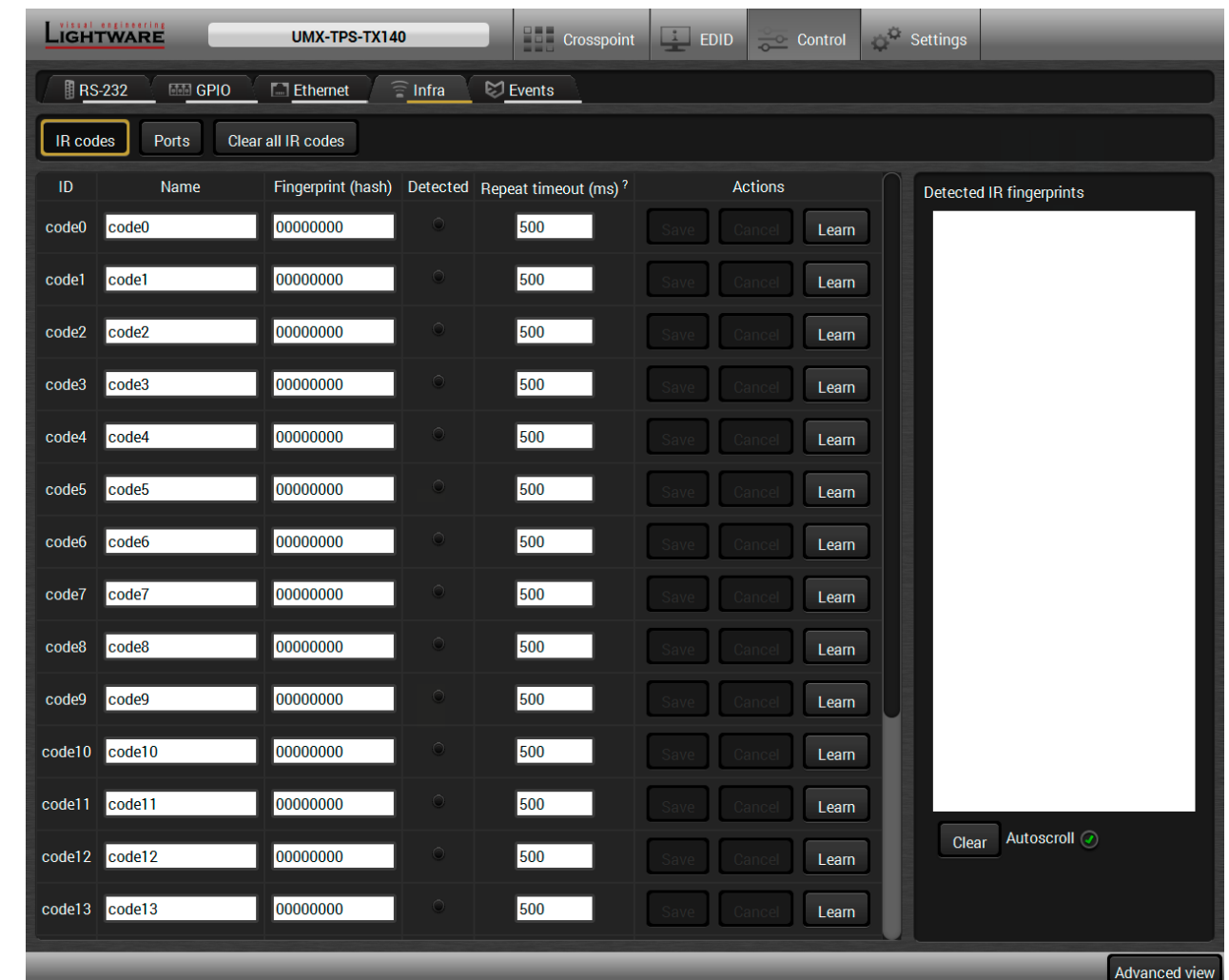

IR codes window in Control menu

Description	Function
ID	Code number.
Name	You can give an unique name for the desired code.
Fingerprint (hash)	Fingerprint code in pronto hexa format.
Detected	Indicator gives feedback about the given IR code is detected currently.
Repeat timeout (ms)	You can set a timeout to avoid the involuntary code recurrence.
Actions	Action buttons for the desired IR code: Save: saving the fingerprint. Cancel: canceling the fingerprint. Learn: learning the detected IR code.
Detected IR fingerprints	You can check the detected IR codes in this panel. Pushing Clear button deleting all current fingerprints and switch on or off the automatic scrolling with the Autoscroll pipe.

20 fingerprints can be stored in the device at the same time. Each of them can be ordered to an action in [Event Manager](#).

Learning IR Codes

- Step 1.** Connect the IR detector unit to the IR IN port of the transmitter.
- Step 2.** Click on the **Learn** button.
- Step 3.** Turn the remote controller to the IR detector. A pop-up window appears in LDC - press your remote button to learn.
- Step 4.** Once the code is received, a new window pops up in LDC - learning completed. Click **OK** to continue.
- Step 5.** Optionally type a unique name for the code in the **Name** text box. The default name is code#, e.g. code0.

Ports Section of the UMX-TPS-TX100 Series Devices

User can set the name and command injection port to each sources and destinations. For more details about IR interface see the [IR Interface](#) section.

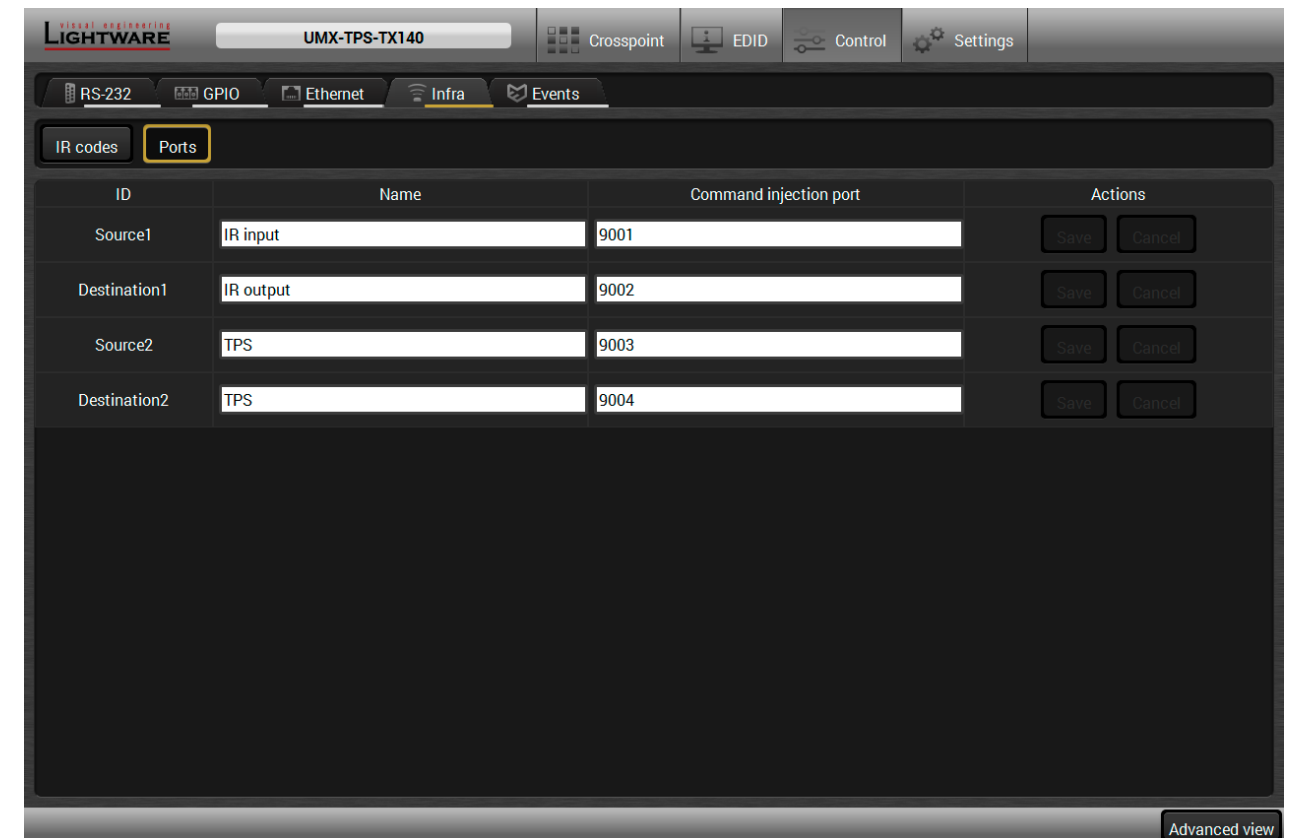

Infra tab - Ports window for the UMX-TPS-TX100 series devices

Ports Section of the UMX-TPS-TX140-Plus UMX-TPS-TX140K and WP-UMX-TPS-TX130-US Models

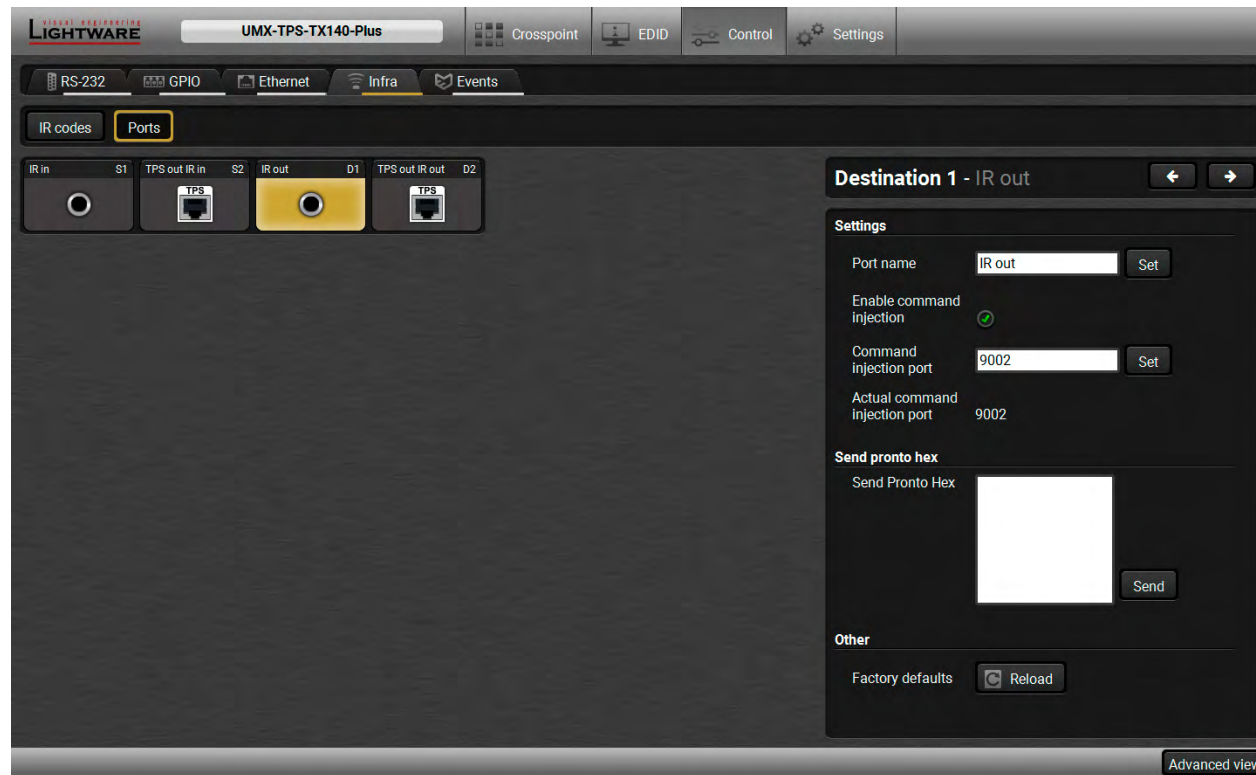

Infra tab - Ports window for the UMX-TPS-TX140-Plus model

The user can set the name and command injection port to each sources and destinations. For more details about IR interface see the [IR Interface](#) section.

The following settings are also available:

- Port name;
- Enable / disable the port;
- Port number;
- Enable / disable command injection;
- Message sending function (little-endian pronto hex code). For more details see the next section;
- Reload [Factory Default Settings](#). `#commandinjection`

Sending pronto hex codes (Little-endian format)

Copy the raw, little endian-format IR code into the **Send Pronto Hex** entry field and click the **Send** button.

The maximum length of the code can be 765 characters (765 bytes). For more details about the accepted IR code formats, see [Sending Pronto Hex Codes in Little-endian Format via IR Port](#) section.

This entry field does not store the code. The code can be saved into the action in the event manager with the following parameters: **Category:** Infra; **Expression:** Send pronto hex; **Port:** D1; **Pronto hex:** <custom_code>

In the Event Manager, the maximum length of the code can be 184 characters (184 bytes).

INFO: Sending bigger endian-format code is available with LW3 protocol command, see [Sending Pronto Hex Codes in Big-endian Format via IR Port](#) section.

Clear all IR codes

Clicking on the button results deleting all stored IR fingerprints.

5.9. Event Manager

The feature means that the device can sense changes on its ports and able to react according to the pre-defined settings. The development idea of the Event manager is based on users' feedbacks. In many cases internal events (such as signal present or HDCP active) are necessary to display but it is not easy when the device is hard to access (e.g. built under the desk).



The Event manager can be configured to perform an action if a condition has been detected. E.g. the desired setup is that after a certain type of signal has been detected on I1 port, the port has to be switched to O1. The settings can be done via the LDC in the Control/Events tab, or by LW3 protocol commands. Configurable events number depends on the device what you are using actually.

Numerous new ideas and requests have been received in connection with the features and settings of the Event manager since the first release. Therefore, the user interface has been re-designed and many new functions implemented. The Event editor can be opened by pressing the **Edit** button at each Event.

There is a **grey bar** on the left of the Event panel in each line. If a condition and an action are set and the Event is enabled, the bar is displayed **in green**.

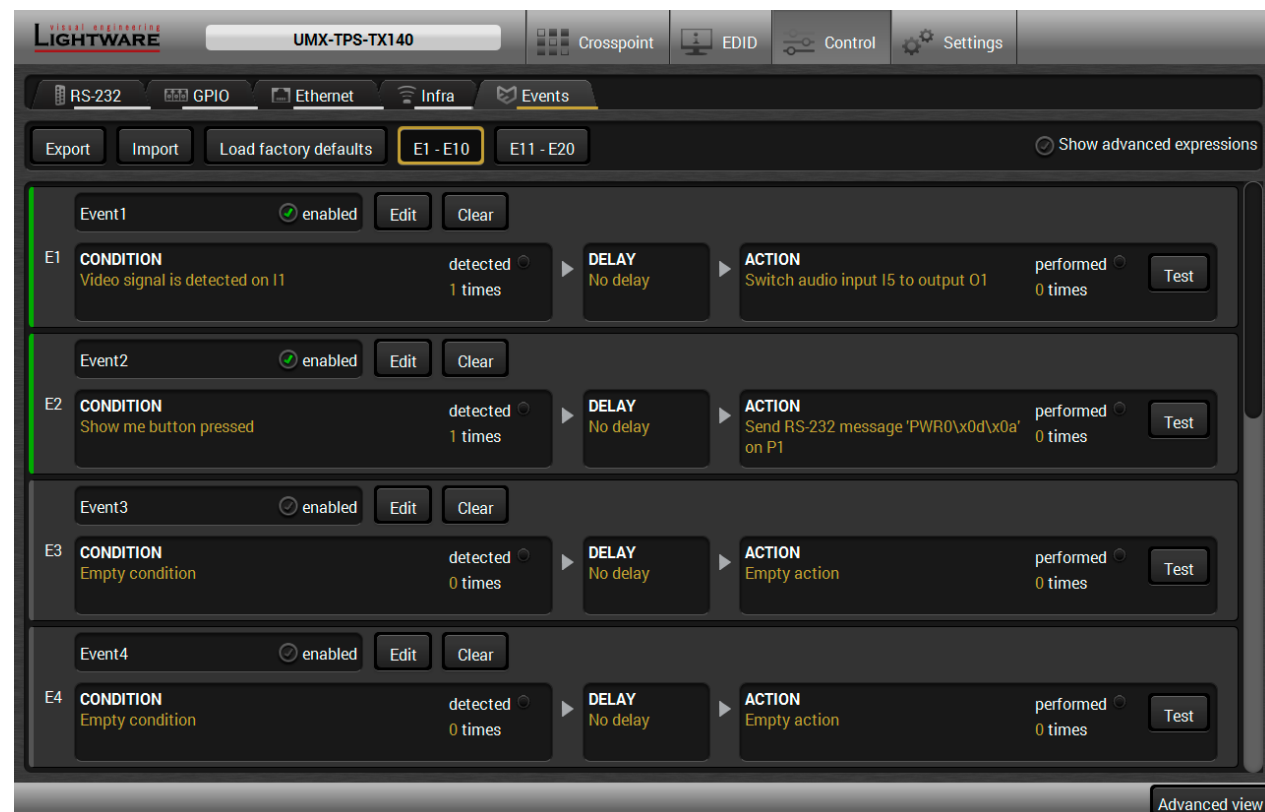

Control menu, Event Manager tab

5.9.1. The Event Editor

Press the **Edit** button in the desired Event line to open the Event editor window.

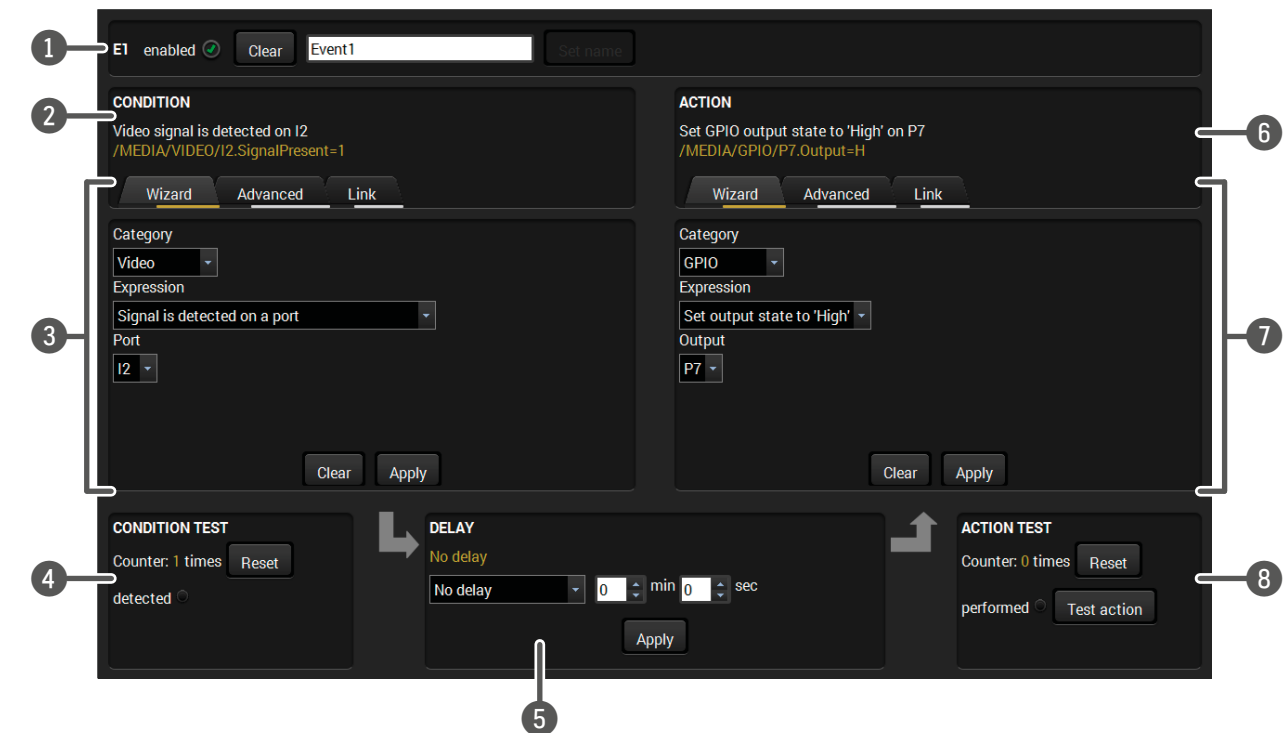

1 **Event header**

The name of the Event is displayed. Type the desired name and press the Set name button. The Event can be cleared by the Clear button. Use the tick mark to enable/disable the Event.

2 **Condition header**

If the condition is set, the description (white colored text) and the exact LW3 protocol expression (yellow colored text) can be seen. If the advanced mode was used the description is "Custom condition".

3 **Condition panel**

The Wizard, the Advanced or the Link tool is available to set the condition. The parameters and settings are displayed below the buttons.

4 **Condition test**

The set condition can be tested to see the working method in the practice.

5 **Delay settings**

The action can be scheduled to follow the condition after the set time value.

6 **Action header**

If the action is set, the description (white colored text) and the exact LW3 protocol expression (yellow colored text) can be seen. If the advanced mode was used the description is "Custom action".

7 **Action panel**

The Wizard, the Advanced or the Link tool is available to set the action. The parameters and settings are displayed below the buttons.

8 **Action test**

The set action can be tested to see the working method in the practice.

5.9.2. Create or Modify an Event

Wizard Mode

The wizard mode lists the most common conditions and actions, so the user does not have to look for LW3 nodes and properties.

- Step 1.** Click on the **Edit** button of the desired Event; the **Event editor** is displayed.
- Step 2.** The wizard mode is displayed as default. Select the desired **Category** first (e.g. Audio or Video).
- Step 3.** Select the desired **Expression** from the drop-down menu. If any other parameter is necessary to set, it is going to be displayed.
- Step 4.** Press the **Apply** button to store the settings of the Condition.

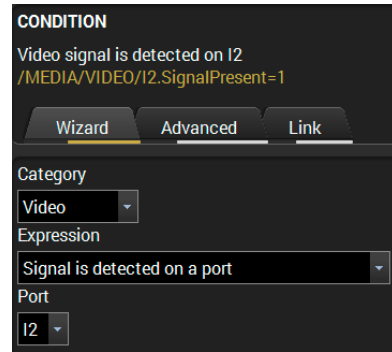

Advanced Mode

The goal of this mode is the same as of the wizard: set the properties and methods for conditions and actions. The difference is the number of the available and usable properties and methods of the LW3 protocol. Advanced mode allows almost all of it.

- Step 1.** Click on the **Edit** button of the desired Event; the **Event editor** is displayed.
- Step 2.** The wizard mode is the default, press the **Advanced** button. The LW3 protocol tree is displayed showing the list of the properties in the drop-down menu. Navigate to the desired node.
- Step 3.** Select the desired **Property** from the menu. The **manual** of the property is displayed below to help to select the necessary property and to set the value.
- Step 4.** Set the desired **value** and **operator**, then press the **Apply** button to store settings.

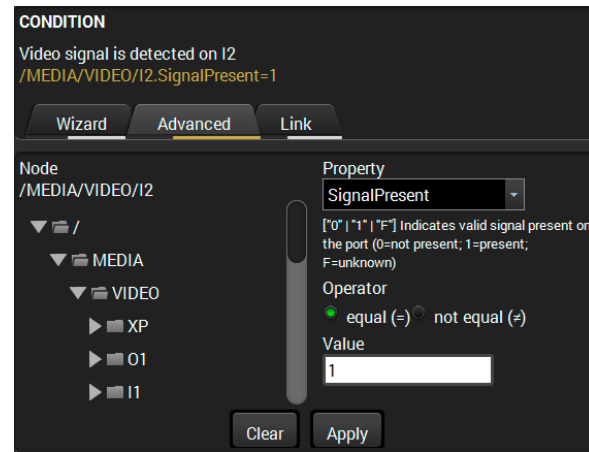

The Link Tool

The new interface allows creating more actions to the same condition. In that case, a condition can trigger more actions. To set such an Event, the Link tool has been introduced.

- Step 1.** Click on the **Edit** button of the desired Event; the **Event editor** is displayed.
- Step 2.** The wizard mode is displayed as default, press the **Link** button.
- Step 3.** All the saved Events are analyzed and the **conditions** are listed (it takes some seconds to finish). The **Show advanced expressions** option allows showing the exact path and set the value of the given property.
- Step 4.** Select the desired **Condition** and press the **Apply** button to store the settings.

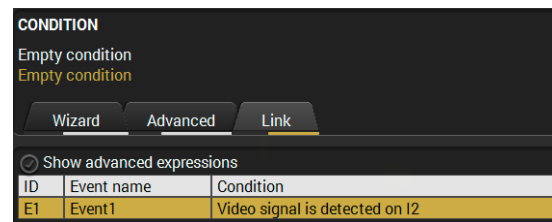

5.9.3. Special Tools and Accessories

The Name of the Event

The name of a port can be changed by typing the new name and clicking the **Set** button. The following characters are allowed when naming:

Letters (A-Z) and (a-z), numbers (0-9), special characters: hyphen (-), underscore (_), and space ().

Enable or Disable an Event

The set Event can be enabled or disabled in the Event list, or directly in the Event editor window by setting the **tick mark** beside the name.

Testing the Condition

When the desired Condition is arranged, the setting can be tested. The Event list and the Event editor contains a small panel that shows if the set condition is detected and how many times. The **Counter** can be reset by the button in Event editor. If the Condition is true, the **detected** mark turns green for two seconds and the **Counter** is increased.

Testing the Action

The method is the same as testing the Condition, but in this case, the Action can be triggered manually by pressing the **Test** button.

TIPS AND TRICKS: The Test button is also placed on the Action panel in the Event list. Thus, you can check the Actions without opening the Event editor.

Delay the Action

In most cases the Action is performed immediately after the Condition is detected. But sometimes a delay is necessary between the Condition and the Action. Therefore, the new Event manager contains the Delay panel which allows that feature with below settings:

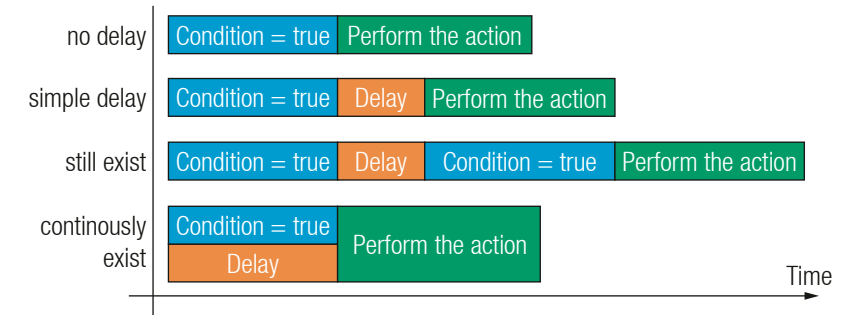

- **No delay:** when the Condition is detected, the Action is launched.
- **Simple delay:** when the Condition is detected, the Action is launched after the set time interval.
- **Still exists:** when the Condition is detected, the Action is launched after the set time interval only if the Condition still exists.
- **Continuously exists:** when the Condition is detected, the Action is launched after the set time interval only if the Condition has been existing continuously.

TIPS AND TRICKS: **Show advanced expressions** option is a useful tool when you look for the path or value of a property but just the expression is displayed. The option is available in the Event list window or when Link tool is used.

5.9.4. Clear One or More Event(s)

Clear an Event

Press the **Clear** button in the Event list or in the header section in the Event editor.

Clear all Events

When all the Events must be cleared press the **Load factory defaults** button above the Event list. You will be prompted to confirm the process.

5.9.5. Export and Import Events

The feature allows saving all the Events. The backup file can be uploaded to another UMX-TPS-TX100 series transmitter.

Export all the Events

Step 1. Press the **Export** button above the Event list.

Step 2. The Save as dialog box will appear. Set the desired folder and file name, then press the **Save** button.

The generated file is a simple text file which contains LW3 protocol commands. The file can be viewed by a simple text editor, e.g. Notepad.

ATTENTION! Editing the file is recommended only for expert users.

Import all the Events

Step 1. Press the **Import** button above the Event list.

Step 2. The Open dialog box will appear. Select the desired folder and file, then press the **Open** button.

5.9.6. Event Creating - Example

The following example shows you on a real-life situation how to set up an Event.

The Concept

The UMX-TPS-TX140 is connected to a projector by the TPS output port. The transmitter is also connected to the projector by the RS-232 port and can send commands via the serial line.

The task is to turn on the projector when signal is detected on the TPS output port.

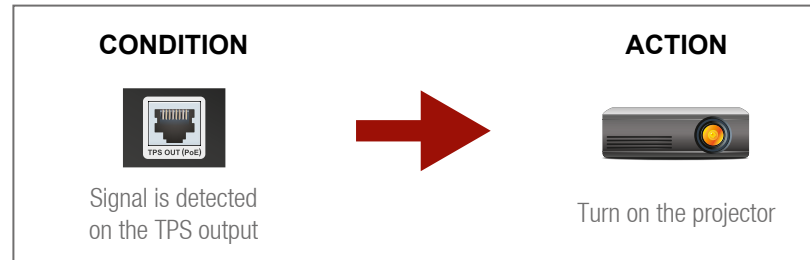

RS-232 Settings

Make sure that the serial line is established between the transmitter and the projector. Check that the RS-232 settings of the transmitter is set exactly the same which required for the projector: baud rate, data bits, parity, stop bits. The transmitter needs to be set to: Control protocol: LW3; and RS-232 mode: Pass-through. See the relevant LDC settings in the [RS-232 Tab](#) section.

Setting the Event

You can create the Event in the Wizard in few simple steps:

Step 1. Set the condition.

Select the required parameters to set the condition:

- **Category:** Video;
- **Expression:** Signal is detected on a port;
- **Port:** 01.

Click on the **Apply** button to complete the procedure. When it is done, the condition appears on the upper side in textual and LW3 command format as well.

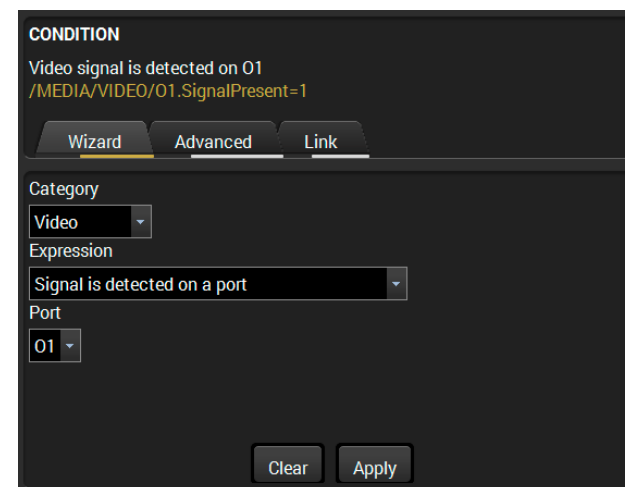

Step 2. Set the action.

If the condition is fulfilled, the following action needs to be launched: the receiver sends a command to the projector over the serial line:

- **Power on** - the required command which is accepted by the projector: PWR0<CR><LF>

For this instance the command has to be closed with the <CR><LF> characters so they need to be escaped. You can use the following format for escaping:

```
<command1><\x0d\x0a><command2><\x0d\x0a>...
...<commandn><\x0d\x0a>
```

In the current case the command is: PWR0\x0d\x0a

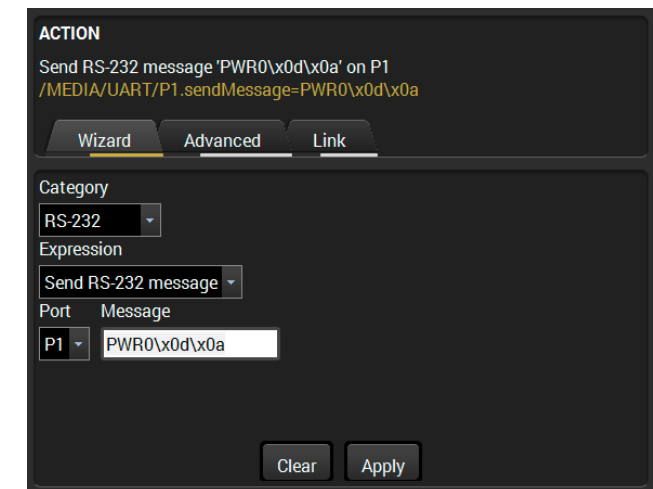

Select the required parameters to set the action:

- **Category:** RS-232;
- **Expression:** Send RS-232 message;
- **Port:** P1;
- **Message:** PWR0\x0d\x0a

Step 3. Enable the Event.

Select the **E1 enabled** pipe in upper left corner to set the Event as launched.

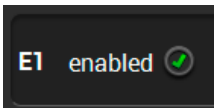

INFO: If you do not find the required category/expression/etc what you need, choose the Advanced mode in the Wizard where the entire LW3 structure tree is available. For example instead of signal detection you can set a specified resolution or color range either as a condition.

5.10. Settings Menu

5.10.1. Status

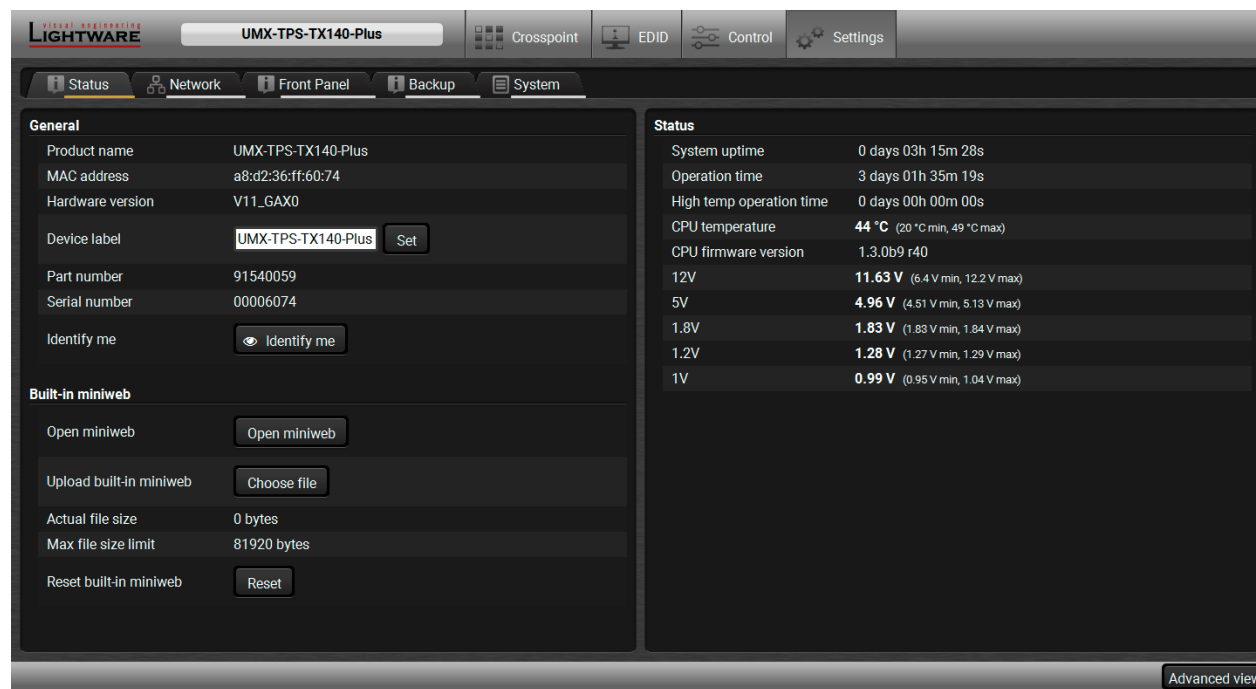

Status tab in Settings menu

The most important hardware and software related information can be found on this tab: hardware and firmware version, serial numbers, temperatures, operation time, and voltage information. Device label can be changed to unique description by the **Set** button. [#status](#) [#devicelabel](#) [#builtinweb](#)

Built-in Miniweb

The built-in website of the transmitter allows to connect and query status information of the transmitter via a web browser.

- System requirements for operating systems: Microsoft Windows XP, Windows Vista, Windows 7, Windows 10, macOS, Linux.
- Compatible Web Browsers: Mozilla Firefox, Google Chrome, Apple Safari.

ATTENTION! Please be sure that the computer is in the same network as the extender. If the computer has multiple Ethernet connections (for example Wi-Fi and LAN connections are used simultaneously) you will have to know the IP address for the one that is used for controlling the extender.

The .html file of the built-in web can be changed by clicking on **Choose file** button. Clicking on the **Reset** button restores the default .html file.

Clicking on the **Open miniweb** button opens the built-in miniweb in the default web browser application.

5.10.2. Network

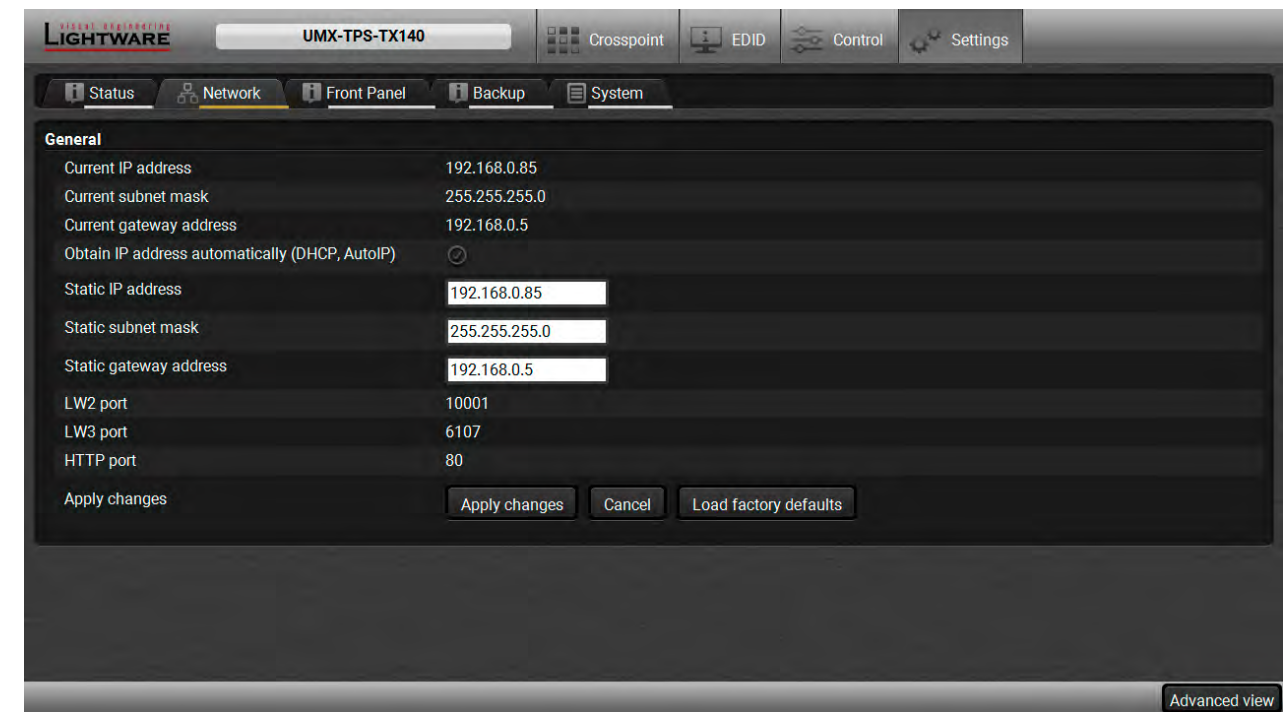

Network tab in Settings menu

IP address and DHCP settings can be set on this tab. Always press the **Apply settings** button to save changes. Factory defaults settings can be recalled with a dedicated button. [#network](#) [#dhcp](#)

5.10.3. Backup

Details about this function can be found in the [Configuration Cloning \(Backup Tab\)](#) section. [#configurationcloning](#)

5.10.4. Front Panel

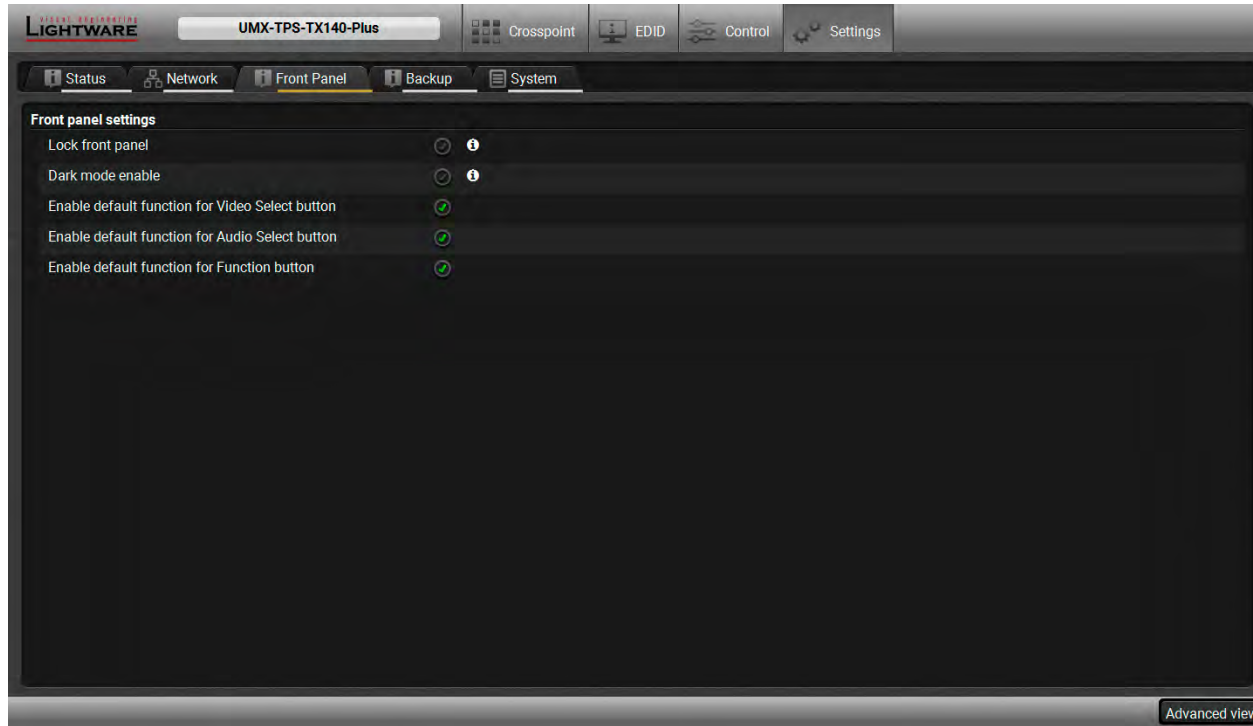

Front panel tab in Settings menu

Front panel operation LEDs and buttons can be configure in this tab.

You can disable the functionality of the front panel buttons with marking the **Button lock** option. This is same method of the control lock made by the front panel buttons. See the details in the [Control Lock](#) section.

- **Lock front panel enable/disable.** This setting is equal with [Control Lock](#). This configuration is also available via LW3 protocol, for more details see [Lock the Front Panel Buttons](#) section.
- **Dark mode enable/disable:** all the LEDs on the front panel of the transmitter unit are turned off 60 seconds after enabling the dark mode. Waking up the device is available by disabling the dark mode. This setting is also available via LW3 protocol, for more details see [Dark Mode](#) section.
- **Enable default function for Video Select/ Audio Select/ Function button.** When this property is disabled, it means that pushing the button will not perform the original function. This makes the button free for programming custom function by [Event Manager](#). This setting is also available via LW3 protocol, for more details see [Disable the Default Function of the Front Panel Buttons](#) section.

`#frontpanel #darkmode #button #controllock`

5.10.5. System

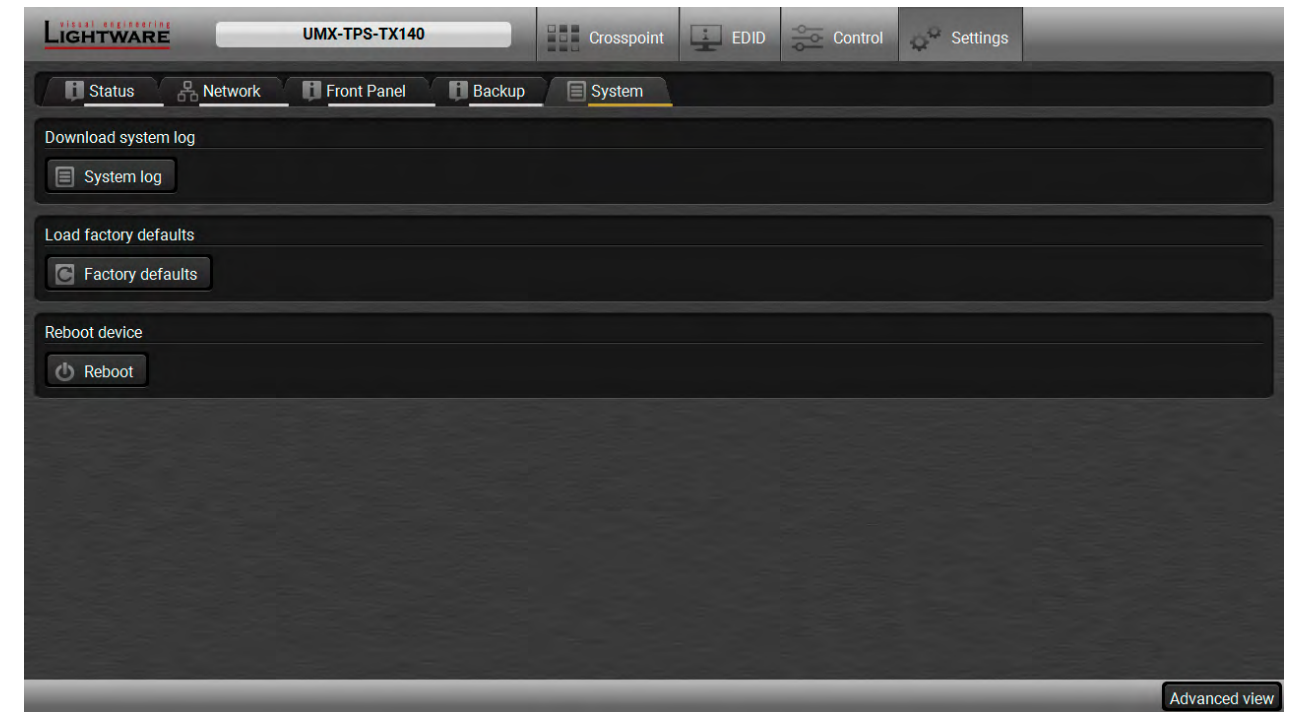

System tab in Settings menu

Three functions are available under System tab:

- **Download system log** - saving the file of the device.
- **Load factory defaults** - recalling factory defaults settings and values. All factory default settings are listed in the [Factory Default Settings](#) section.
- **Reboot** - rebooting the system.

`#factorydefaults #reboot #reset #restart`

5.11. Configuration Cloning (Backup Tab)

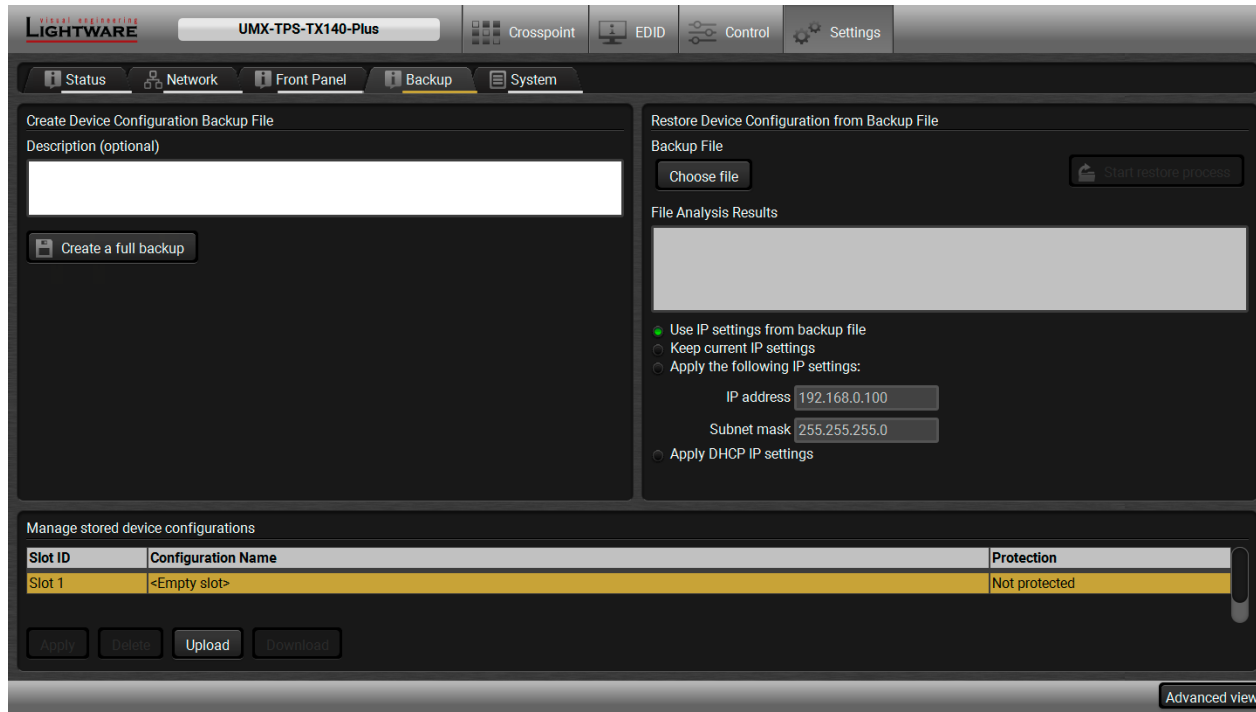

Backup tab

Configuration cloning of Lightware LW3 devices is a simple method that eliminates the need to repeatedly configure certain devices to have identical (non-factory) settings. If the devices are installed in the same type of system multiple times then it is enough to set up only one device to fit the user's needs and then copy those settings to the others, thus saving time and resources.

5.11.1. Steps in a Nutshell

Installing multiple devices with the same customized configuration settings can be done in a few easy steps:

- Step 1.** Configure one device with all your desired settings using the LDC software.
- Step 2.** Backup the full configuration file to your computer.
- Step 3.** If needed, make some modifications to the configuration file using a text editor (e.g. Notepad). E.g. modifying the static IP address is necessary when DHCP is not used.
- Step 4.** Connect to the other device which has to be configured and upload (restore) your configuration file.
- Step 5.** Done! You can have as many totally identical, customized devices as you like. *#configurationcloning #backup*

5.11.2. Save the Settings of a Device (Backup)

- Step 1.** Apply the desired settings in the transmitter (port parameters, crosspoint, etc.)
- Step 2.** Select the **Settings / Backup** tab from the menu.
- Step 3.** Write a short **description** in the text box on the left (optional).
- Step 4.** Press the **Create a full backup** button. You will be prompted to save the file to the computer. The default file name is the following:

```
BACKUP_<DEVICE TYPE>_SN<SERIAL NUMBER>.LW3
```

- Step 5.** Set the desired **file name**, select the folder and **save** the file.

TIPS AND TRICKS: Using the exact product type in the filename is recommended since it makes the file usage more comfortable.

About the Backup File

The backup file is a simple text file which contains LW3 protocol commands. The first line is the description and the further lines are the commands which will be executed during the restore process. The file can be viewed (and/or edited) by a simple text editor, e.g. Notepad.

See the entire list of saved data in the [Content of Backup File](#) section.

ATTENTION! Editing the command lines is only recommended for expert users.

5.11.3. Upload the Settings to a Device (Restore)

WARNING! Please note that the settings will be permanently overwritten with the restored parameters in the device. Undo is not available.

ATTENTION! The cloning is successful when the backup file is downloaded from the same type of source device as the destination device.

The Restoring Process

- Step 1.** Select the **Settings / Backup** tab from the menu.
- Step 2.** Click on the **Choose file** button on the right panel and **browse** to the desired file.
- Step 3.** The file is verified and the result will be displayed in the textbox below. If the file is correct, then the settings can be restored.
- Step 4.** Choose **IP settings** what you want to use after backup. You can apply settings from the backup file, keep actual settings, set it manually in a dialog box or apply DHCP.
- Step 5.** Press the **Start restore process** button and click on the **Yes** button when asked.
- Step 6.** Reboot the device to apply the network settings after finishing.

5.12. Advanced View Window

Advanced view is the surface for displaying the LW3 protocol tree. Commands and specific parameters (which are not available on the graphical user interface of the LDC) can be run and set by the controlling tools.

`#advancedview #terminal`



1 LW3 protocol help

Pushing the button results a help window opening which describes important information about LW3 protocol commands in HTML format.

2 Edit mode

The default appearance is the read-only mode. If you want to edit values or parameters, tick the option. You will be prompted for confirmation selection.

3 Warning mode

If this pipe checked in, a warning window pops up when you enter a command.

4 Node list

Correspondent parameters and nodes are shown which are connected to the selected item in the protocol tree.

Manual button: Manual (short description) of the node can be displayed in the terminal window.

Set button: Saves the value/parameter typed in the text field.

Call button: Calls the method, e.g. reloads factory default values.

5 Protocol tree

LW3 protocol tree; select an item to see its content.

6 Command line

Type the desired command and execute it by the **Send** button. The terminal window shows commands and responses in the Terminal window by the **Clear** button.

7 Terminal window

Commands and responses with time and date are listed in the terminal window. The command starts with '>' character, received response starts with '<' character. The color of each item depends on the type of the command. The content of the window can be emptied by the **Clear** button. If the option is ticked, the list is scrolled automatically when a new command is entered.

6

LW2 Programmer's Reference

The device can be controlled through a reduced command set of LW2 protocol commands to ensure the compatibility with other Lightware products. The supported LW2 commands are described in this chapter.

- ▶ AV PORT SETTINGS
- ▶ NETWORK CONFIGURATION
- ▶ GPIO CONFIGURATION
- ▶ LW2 COMMANDS – QUICK SUMMARY
- ▶ OVERVIEW
- ▶ PROTOCOL RULES

6.1. LW2 Protocol Description

The device accepts commands surrounded by curly brackets - {} - and responds data surrounded by round brackets - () - only if a command was successfully executed.

Format	Explanation
<in>	Input number in 1 or 2 digit ASCII format (01, 5, 07, 16, etc.)
<out>	Output number in 1 or 2 digit ASCII format
<in ² >	Input number in 2 digit ASCII format (01, 02, 10, 12 etc.)
<out ² >	Output number in 2 digit ASCII format (01, 02, 10, 12 etc.)
<loc>	Location number in 1, 2 or 3 digit ASCII format
<id>	id number in 1 or 2 digit ASCII format
<id ² >	id number in 2 digit ASCII format
CrLf	Carriage return, Line feed (0x0D, 0x0A)
•	Space character (0x20)
→	Each command issued by the controller
←	Each response received from the router

6.2. General LW2 Commands

6.2.1. View Product Type

Description: The device responds its name.

Format	Example
Command {i} Response (I:<PRODUCT_TYPE>)CrLf	→ {i} ← (I:UMX-TPS-TX140)

Explanation: The connected device is a UMX-TPS-TX140.

Legend: <PRODUCT_TYPE> shows type.

6.2.2. Query Control Protocol

Description: The device can be controlled with different control protocols. This command queries the active protocol of the currently used control interface. *#controlprotocol*

Format	Example
Command {P_?} Response (CURRENT•PROTOCOL••#<protocol>) CrLf	→ {P_?} ← (CURRENT PROTOCOL = #1)

Explanation: The device communicates with LW2 protocol.

6.2.3. View Firmware Version of the CPU

Description: View the CPU firmware revision. *#firmwareversion*

Format	Example
Command {f} Response (FW:<FW_VER><s>)CrLf	→ {f} ← (FW:1.3.2b1 r43)

Legend: <FW_VER> is the firmware version. It is followed by <s> string which may indicate special versions.

6.2.4. Connection Test

Description: Simple test to see if the connection is established successfully.

Format	Example
Command {PING} Response (PONG!)CrLf	→ {ping} ← (PONG!)

6.2.5. View Serial Number

Description: The device responds its 8-digit serial number.

Format	Example
Command {s} Response (SN:<SERIAL_N>)CrLf	→ {s} ← (SN:5A003192)

6.2.6. Compile Time

Description: Returns the date, when the microcontroller firmware was compiled.

Format	Example
Command {CT} Response (Complied: <DATE&TIME>)CrLf	→ {ct} ← (Compiled: May 11 2019 11:10:09)

6.2.7. View Installed Board

Description: Shows the hardware name and revision of the installed card.

Format	Example
Command {is} Response (SL#●0●<MB_DESC>)CrLf (SL●END)CrLf	→ {is} ← (SL# 0 UMX-TPS-TX140 V11_2A) ← (SL END)

Explanation: The device reports its motherboard (slot 0).

6.2.8. View Firmware for All Controllers

Description: Shows the firmware versions of all installed controllers. *#firmwareversion*

Format	Example
Command {FC} Response (CF●<DESC>)CrLf (CF●<DESC>)CrLf ... (CF END)CrLf	→ {fc} ← (CF UMX-TPS-TX140 1.3.2b1 r43) ← (SL END)

Explanation: The device has one control panel.

6.2.9. Restart the Device

Description: The device can be restarted without unplugging power. *#reset #restart reboot*

Format	Example
Command {RST} Response	→ {rst}

Explanation: The device reboots; no response is sent in this case.

6.2.10. Query Health Status

Description: Internal voltages and measured temperature values are shown.

Format	Example
Command {ST} Response (ST●<DESC>)CrLf	→ {st} ← (ST CPU 11.61V 5.03V 1.84V 1.28V 0.99V 42.24C 42.23C)

6.2.11. Restore Factory Default Settings

Description: Settings can be reset to factory default values as follows: *#factorydefault*

Format	Example
Command {FACTORY=ALL} Response (FACTORY ALL...)CrLf	→ {factory=all} ← (FACTORY ALL...)

Explanation: All settings and parameters are reset to factory default, see the table in the [Factory Default Settings](#) section.

6.3. AV Port Settings

6.3.1. Switch an Input to the Output

Following commands with <A/V/AV> option can take effect in multiple layers, according to their parameters. Depending on 'A' or 'V' it can change only the Audio or only the Video layer; or 'AV' changes both.

INFO: <A/V/AV> option usually can be skipped for legacy purposes. In this case, the devices change all (Video & Audio) layers but using status commands it displays information about only the Video layer. Please use AV option, when available.

Description: Switch input <in> to output <out>. *#audio*

Format	Example
Command {<in>@<out>●<layer>} Response (O<out>²●<in>²●<layer>)CrLf	→ {2@1 AV} ← (001 I02 AV)

Explanation: I2 audio and I2 video input ports are switched to O1 output port.

Legend:

<layer>	Layer
A	Audio layer
V	Video layer
AV (or nothing)	Audio & Video layer

<out>: O1 output port.
<in>: I1...I6 input ports.

ATTENTION! The response of this command does not show if the output is muted. To check the mute status a separate query has to be used like {VC}.

ATTENTION! Analog video inputs does not contain embedded audio. If you use the AV option in case of VGA input (I1) the audio will be switched to the analog audio input 1 (I1) and in case of DVI-A input (I5) the audio will be switched to the analog audio input 2 (I5).

6.3.2. Mute Output

Description: Mute output <out>. The output signal is turned off.

Format	Example
Command {#<out>●<layer>} Response (1MT<out>²●<layer>)CrLf	→ {#01 A} ← (1MT01 A)

Explanation: O1 audio port is muted.

ATTENTION! Muting does not change the crosspoint's state but disables the output itself. This way the last connection can be easily restored with an unmute command. Switching a muted output does not unmute the output.

6.3.3. Unmute Output

Description: Unmute output <out>.

Format	Example
Command {+<out>●<layer>} Response (0MT<out>²●<layer>)CrLf	→ {+01 V} ← (0MT01 V)

Explanation: O1 video port is unmuted.

INFO: Unmuting an output makes the previous connection active as the crosspoint state has not been changed by the muting command, only the output was disabled.

6.3.4. Lock Output

Description: Lock an output port. Output's state cannot be changed until unlocking.

Format	Example
Command {#<out>●<layer>} Response (1LO<out>²●<layer>)CrLf	→ {#>01 A} ← (1L001 A)

Explanation: O1 audio output port is locked.

6.3.5. Unlock Output

Description: Unlock an output port. The connection on output can be changed.

Format	Example
Command {+<out>●<layer>} Response (0LO<out>²●<layer>)CrLf	→ {+<01 V} ← (0L001 V)

Explanation: O1 video output port is unlocked.

INFO: The device issues the above response regardless of the previous state of the output (either it was locked or unlocked). *#mute #unmute #lock #unlock*

6.3.6. View Connection State on the Output

Description: Viewing the crosspoint state of the device; showing the input port numbers connected to the outputs.

Format	Example
Command {VC<layer>} Response (ALL<layer>●<001>●<002>)CrLf	→ {VC AV} ← (ALLV 02) ← (ALLA 05)

Legend: 001 shows the corresponding output's connection state.

<layer>	Layer
A	Audio layer
V	Video layer
AV *	Audio & Video layer

* AV is not used in the response. When AV is typed in the commands, the response will result two lines, one for the Video and one for the Audio port states.

State letters:

Letter	State	Example
L	Output is locked	L01
M	Output is muted	M01
U	Output is locked and muted	U01

Explanation: I2 video input port is connected to the video output port and I5 audio input port is connected to the audio output port. *#state*

6.3.7. View Crosspoint Size

Description: Shows the physical crosspoint size.

Format	Example
Command {getsize●<layer>} Response (SIZE=<size>●<layer>)CrLf	→ {GETSIZE AV} ← (SIZE=6x1 V) ← (SIZE=5x1 A)

Legend:

<size>: <number of inputs>x<number of outputs>
<layer>: See details in the previous section.

Explanation: The device reports that it has a video crosspoint with 6 inputs (Test pattern is the 6th input) and 1 output and an audio crosspoint with 5 inputs and 1 output.

6.3.8. Change Video Autoselect Mode

Description: The autoselect mode of the video outputs can be changed.

Format	Example
Command {AS_V<out>=<state>;<mode>} Response (AS_V<out>=<state>;<mode>)CrLf	→ {as_v1=E;P} ← (AS_V1=E;P)

Legend: The output numbers are listed in [Port Numbering](#) section.

Letter	<state>
F	First detect mode
P	Priority detect mode
L	Last detect mode

Letter	<mode>
E	Autoselect mode is enabled
D	Autoselect mode is disabled

Explanation: The Autoselect mode of video output1 is enabled and set to Priority mode.

INFO: The Autoselect mode can be queried by typing the "as_v<out>=?" command. *#autoselect*

6.3.9. Change Audio Autoselect Mode

Description: The autoselect mode of the audio outputs can be changed.

Format	Example
Command {AS_A<out>=<state>;<mode>} Response (AS_A<out>=<state>;<mode>)CrLf	→ {as_a1=E;P} ← (AS_A1=E;P)

Legend: The output numbers are listed in [Port Numbering](#) section.

Letter	<state>
F	First detect mode
P	Priority detect mode
L	Last detect mode

Letter	<mode>
E	Autoselect mode is enabled
D	Autoselect mode is disabled

Explanation: The Autoselect mode of audio output1 is enabled and set to Priority mode.

INFO: The Autoselect mode can be queried by typing the "as_v<out>=?" command. *#audio*

6.3.10. Change the Video Input Priorities

Description: The settings of video input priority can be changed as follows. *#autoselect*

Format	Example
Command {PRIO_V<out>=<in ¹ _prio>;<in ² _prio>;...;<in ⁿ _prio>} Response (PRIO_V<out>=<in ¹ _prio>;<in ² _prio>;...;<in ⁿ _prio>)CrLf	→ {prio_v1=1;0;2;3;4;5} ← (PRIO_V1=1;0;2;3;4;5)

Legend:

<out>: The output port number: V1
<in¹_prio>...<inⁿ_prio>: Priority number of the input ports. See more details about port numbering in the [Port Numbering](#) section.

Explanation: Input 2 has the highest priority (0), Input 1 has the second highest (1). Input 6 has the lowest priority (5).

ATTENTION! Always set all the priority of the ports when changing, otherwise, the change will not be executed and the response will be the current setting (like querying the priority setting).

INFO: In this case, the outputs are linked; the change will affect both local and fiber optical output ports.

INFO: The video priorities can be queried by typing the “prio_v<out>=?” command.

6.3.11. Change Audio Input Priority

Description: The settings of video input priority can be changed as follows. *#audio*

Format	Example
Command {PRIO_A<out>=<in ¹ _prio>;<in ² _prio>;...;<in ⁿ _prio>} Response (PRIO_A<out>=<in ¹ _prio>;<in ² _prio>;...;<in ⁿ _prio>)CrLf	→ {prio_a1=1;0;2;3;4} ← (PRIO_A1=1;0;2;3;4)

Legend:

<out>: The output port number: A1
<in¹_prio>...<inⁿ_prio>: Priority number of the input ports. See more details about port numbering in the [Port Numbering](#) section.

Explanation: Input 2 has the highest priority (0), Input 1 has the second highest (1). Input 5 has the lowest priority (4).

ATTENTION! Always set all the priority of the ports when changing, otherwise, the change will not be executed and the response will be the current setting (like querying the priority setting).

INFO: In this case, the outputs are linked; the change will affect both local and fiber optical output ports.

INFO: The audio priorities can be queried by typing the “prio_a<out>=?” command.

6.4. Network Configuration

6.4.1. Query the Current IP Status

Description: IP address settings can be queried as follows.

Format	Example
Command {IP_STAT=?} Response (IP_STAT=<type>;<ip_address>;<subnet_mask>;<gateway_addr>)CrLf	→ {ip_stat=?} ← (IP_STAT=0;192.168.0.100;255.255.255.0;192.168.0.1)

Legend:

<type>: 0 = static IP; 1 = DHCP.
<ip_addr>: IP address (four decimal octets separated by dots).
<subnet_mask>: Subnet mask (four decimal octets separated by dots).
<gateway_addr>: Gateway address (four decimal octets separated by dots).

Explanation: The device has a static (fix) IP address: 192.168.0.100; the subnet mask is 255.255.255.0, the gateway address is 192.168.0.1.

6.4.2. Set the IP Address

Description: IP address can be set as follows. *#network #ipaddress*

Format	Example
Command {IP_ADDRESS=<type>;<ip_address>} Response (IP_ADDRESS=<type>;<ip_address>)CrLf	→ {ip_address=0;192.168.0.110} ← (IP_ADDRESS=0;192.168.0.110)

Legend: <type>: 0 = static IP; 1 = DHCP

INFO: The IP address can be queried by typing the “ip_address=?” command. The response contains the fix IP address that is stored in the device even if DHCP is enabled; in this case, this IP address is not valid.

6.4.3. Set the Subnet Mask

Description: Subnet mask can be set as follows.

Format	Example
Command {IP_NETMASK=<subnet_mask>} Response (IP_NETMASK=<subnet_mask>)CrLf	→ {ip_netmask=255.255.255.0} ← (IP_NETMASK=255.255.255.0)

Legend: <subnet_mask>: Four decimal octets separated by dots.

INFO: The subnet mask can be queried by typing the “ip_address=?” command. The response contains the fix IP subnet mask that is stored in the device even if DHCP is enabled; in this case, this IP subnet mask is not valid.

6.4.4. Set the Gateway Address

Description: Gateway address can be set as follows. *#network #ipaddress*

Format	Example
Command {IP_GATEWAY=<gateway_addr>}	→ {ip_gateway=192.168.0.50}
Response (IP_GATEWAY=<gateway_addr>)CrLf	← (IP_GATEWAY=192.168.0.50)

Legend: <gateway_addr>: Four decimal octets separated by dots.

INFO: The gateway address can be queried by typing the "ip_gateway=?" command. The response contains the static IP gateway address that is stored in the device even if DHCP is enabled. In that case, the latest valid gateway address (for static IP) is stored.

6.4.5. Apply Network Settings

Description: Apply the network settings and restart the network interface.

Format	Example
Command {ip_apply}	→ {ip_apply}
Response (IP_APPLY)CrLf	← (IP_APPLY)

6.5. GPIO Configuration

6.5.1. Set Level and Direction for Each Pins

Description: GPIO pins can be configured as follows. See more details about GPIO connector in the section and about the interface in the section. *#gpio*

Format	Example
Command {GPIO<pin_nr>=<dir>;<level>}	→ {gpio1=0;H}
Response (GPIO<pin_nr>=<dir>;<level>)CrLf	← (GPIO1=0;H)

Legend:

- <pin_nr>: GPIO pin number 1...8
- <dir>: The direction of the communication, it can be input or output.
- <level>: The level of the pin, it can be low or high.

Parameter <dir>	Description
I	Input
O	Output

Parameter <level>	Description
L	Low
H	High
T	Toggle

Explanation: GPIO pin 1 is set to output with high level.

INFO: The current GPIO pin configuration can be queried by typing the {GPIO<pin_nr>=?} command.

6.6. LW2 Commands – Quick Summary

General LW2 Commands

Operation	See in section	Command
View Product Type	6.2.1	{I}
Query Control Protocol	6.2.2	{P_?}
View Firmware Version of the CPU	6.2.3	{F}
Connection Test	6.2.4	{PING}
View Serial Number	6.2.5	{S}
Compile Time	6.2.6	{CT}
View Installed Board	6.2.7	{IS}
View Firmware for All Controllers	6.2.8	{FC}
Restart the Device	6.2.9	{RST}
Change the Video Input Priorities	6.2.10	{ST}
Restore Factory Default Settings	6.2.11	{FACTORY=ALL}

AV Port Settings

Operation	See in section	Command
Switch an Input to the Output	6.3.1	{<in>@<out>●<layer>}
Mute Output	6.3.2	{#<out>●<layer>}
Unmute Output	6.3.3	{+<out>●<layer>}
Lock Output	6.3.4	{#><out>●<layer>}
Unlock Output	6.3.5	{+<out>●<layer>}
View Connection State on the Output	6.3.6	{VC●<layer>}
View Crosspoint Size	6.3.7	{GETSIZE●<layer>}
Change Video Autoselect Mode	6.3.8	{AS_V<out>=<state>;<mode>;<no_signal>}
Change Audio Autoselect Mode	6.3.9	{AS_A<out>=<state>;<mode>;<no_signal>}
Change the Video Input Priorities	6.3.10	{PRIO_V<out>=<in_1_prio>;...;<in_n_prio>}
Change Audio Input Priority	6.3.11	{PRIO_A<out>=<in_1_prio>;...;<in_n_prio>}

Network Configuration

Operation	See in section	Command
Query the Current IP Status	6.4.1	{IP_STAT=?}
Set the IP Address	6.4.2	{IP_ADDRESS=<type>;IP_ADDRESS}
Set the Subnet Mask	6.4.3	{IP_NETMASK=<subnet_mask>}
Set the Gateway Address	6.4.4	{IP_GATEWAY=<gateway_address>}
Apply Network Settings	6.4.5	{IP_APPLY}

GPIO Configuration

Operation	See in section	Command
Set Level and Direction for Each Pins	6.5.1	{GPIO<pin_nr>=<dir>;<level>}

7

LW3 Programmers' Reference

The device can be controlled through Lightware 3 (LW3) protocol commands to ensure the compatibility with other Lightware products. The supported LW3 commands are described in this chapter.

- ▶ [SYSTEM COMMANDS](#)
- ▶ [VIDEO PORT SETTINGS](#)
- ▶ [AUDIO PORT SETTINGS](#)
- ▶ [ANALOG AUDIO INPUT LEVEL SETTINGS](#)
- ▶ [NETWORK CONFIGURATION](#)
- ▶ [RS-232 PORT CONFIGURATION](#)
- ▶ [RS-232 RECOGNIZER](#)
- ▶ [INFRARED PORT CONFIGURATION](#)
- ▶ [SENDING MESSAGE VIA THE COMMUNICATION PORTS](#)
- ▶ [SENDING CEC COMMANDS](#)
- ▶ [GPIO PORT CONFIGURATION](#)
- ▶ [EDID MANAGEMENT](#)
- ▶ [LW3 COMMANDS - QUICK SUMMARY](#)
- ▶ [ABOUT THE FIRMWARE PACKAGE \(LFP2 FILE\)](#)
- ▶ [SHORT INSTRUCTIONS](#)

7.1. Overview

The Lightware Protocol #3 (LW3) is implemented in almost all new Lightware devices (matrix switchers, signal extenders and distribution amplifiers) since 2012. The protocol is ASCII-based and all commands are terminated with a carriage return (Cr, '\r') and line feed (Lf, '\n') pair. It is organized as a tree structure that provides outstanding flexibility and user-friendly handling with 'nodes', 'properties' and 'methods'. The **Advanced View** of the Lightware Device Controller software is the perfect tool for browsing and learning how the LW3 protocol can be used in practice.

7.2. Protocol Rules

7.2.1. LW3 Tree Structure and Command Structure (examples)

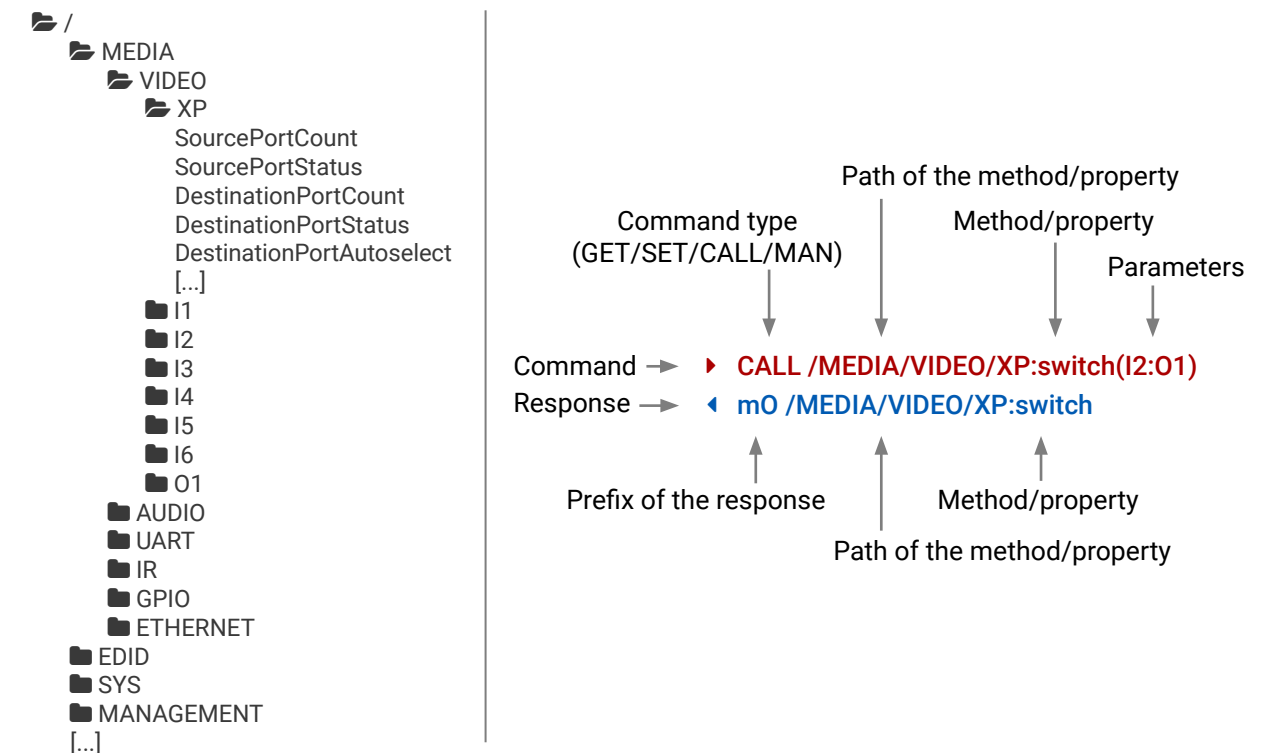

7.2.2. General Rules

- All names and parameters are **case-sensitive**.
- The nodes are separated by a slash (/) character.
- The node name can contain the elements of the English alphabet and numbers.
- Use the **TCP port no. 6107** when using LW3 protocol over Ethernet.
- When a command is issued by the device, the received response cannot be processed by the CPU.
- The node paths describe the exact location of the node, listing each parent node up to the root.

7.2.3. Command Types

GET command

The **GET** command can be used to get the child nodes, properties and methods of a specific node. It can also be used to get the value of a property. Use the dot character (.) when addressing a property:

- ▶ **GET /.SerialNumber**
- ◀ **pr /.SerialNumber=87654321**

GETALL command

The **GETALL** command can be used to get all child nodes, properties and methods of a node with one command.

- ▶ **GETALL /MEDIA/UART**
- ◀ **ns /MEDIA/UART/P1**
- ◀ **ns /MEDIA/UART/P2**
- ◀ **pr /MEDIA/UART.PortCount=2**
- ◀ **pr /MEDIA/UART.PortUi=P1:12209;P2:12224**
- ◀ **pr /MEDIA/UART.P1=Local RS-232**
- ◀ **pr /MEDIA/UART.P2=TPS out RS-232**

SET command

The **SET** command can be used to modify the value of a property. Use the dot character (.) when addressing the property:

- ▶ **SET /MEDIA/VIDEO/I1.ColorSpaceMode=0**
- ◀ **pw /MEDIA/VIDEO/I1.ColorSpaceMode=0**

CALL command

A method can be invoked by the **CALL** command. Use the colon character (:) when addressing the method:

- ▶ **CALL /MEDIA/VIDEO/XP:switch(I1:01)**
- ◀ **mO /MEDIA/VIDEO/XP:switch**

MAN command

The manual is a human readable text that describes the syntax and provides a hint for how to use the primitives. For every node, property and method in the tree there is a manual, type the MAN command to get the manual:

- ▶ **MAN /MEDIA/VIDEO/O1.Pwr5vMode**
- ◀ **pm /MEDIA/VIDEO/O1.Pwr5vMode ["0" | "1" | "2"] 0 - Auto, 1 - Always On, 2 - Always Off**

7.2.4. Prefix Summary

DEFINITION: The prefix is a 2-character long code that describes the type of the response.

The following prefixes are defined in the LW3 protocol:

Prefix	Description	Prefix	Description
n-	a node	pm	a manual for the property
nE	an error for a node	m-	a method
nm	a manual for a node	mO	a response after a success method execution
pr	a read-only property	mF	a response after a failed method execution
pw	read-write property	mE	an error for a method
pE	an error for the property	mm	a manual for a method

7.2.5. Error Messages

There are several error messages defined in the LW3 protocol, all of them have a unique error number.

- ▶ **CALL /MEDIA/VIDEO/XP:switch(IA:01)**
- ◀ **mE /MEDIA/VIDEO/XP:switch %E004:Invalid value**

7.2.6. Escaping

DEFINITION: An escape sequence is a sequence of characters that does not represent itself when used inside a character or string literal, but is translated into another character or a sequence of characters.

Property values and method parameters can contain characters which are used as control characters in the protocol. They must be escaped. The escape character is the backslash (\) and escaping means injecting a backslash before the character that should be escaped (like in C language).

Control characters are the following: \ { } # % () \r \n \t

The **original** message: **CALL /MEDIA/UART/P1:sendMessage(Set(01))**

The **escaped** message: **CALL /MEDIA/UART/P1:sendMessage(Set\01\))**

7.2.7. Signature

DEFINITION: The signature is a four-digit-long hexadecimal value that can be optionally placed before every command to keep a command and the corresponding responses together as a group.

Each line is terminated with a carriage return (Cr, '\r') and line feed (Lf, '\n') characters. In several cases the number of the lines in the response cannot be determined in advance, e.g. the client intends to receive for the whole response and also wants to be sure, that the received lines belong together and to the same command. In these cases, a special feature the 'signature' can be used. The response to that particular command will also be preceded by the signature, and the corresponding lines will be between brackets:

```
▶ 1700#GET /EDID.*
◀ {1700
◀ pr /EDID.EdidStatus=F89:E1;D1:E2;D1:E3;D1:E4;F89:E5
◀ m- /EDID:copy
◀ m- /EDID:delete
◀ m- /EDID:reset
◀ m- /EDID:switch
◀ m- /EDID:switchAll
◀ }
```

INFO: The lines of the signature are also Cr and Lf terminated.

7.2.8. Subscription

DEFINITION: Subscription to a node means that the user will get a notification if a property of the node changes.

A user can subscribe to any node. These notifications are asynchronous messages and are useful to keep the client application up to date, without having to periodically poll the node to detect a changed property. When the user does not want to be informed about the changes anymore, he can simply unsubscribe from the node.

ATTENTION! The subscriptions are handled separately for connections. Hence, if the connection is terminated all registered subscriptions are deleted. After reopening a connection all subscribe commands have to be sent in order to get the notifications of the changes on that connection.

Subscribe to a Node

```
▶ OPEN /MEDIA/VIDEO
◀ o- /MEDIA/VIDEO
```

Get the Active Subscriptions

```
▶ OPEN
◀ o- /MEDIA/VIDEO
◀ o- /EDID
◀ o- /DISCOVERY
```

Subscribe to Multiple Nodes

```
▶ OPEN /MEDIA/VIDEO/*
◀ o- /MEDIA/VIDEO/*
```

Unsubscribe from a Node

```
▶ CLOSE /MEDIA/VIDEO
◀ c- /MEDIA/VIDEO
```

Unsubscribe from Multiple Nodes

```
▶ CLOSE /MEDIA/VIDEO/*
◀ c- /MEDIA/VIDEO/*
```

7.2.9. Notifications about the Changes of the Properties

When the value of a property is changed and the user is subscribed to the node, which the property belongs to, an asynchronous notification is generated. This notification is called as the 'change message'. The format of such a message is very similar to the response for the **GET** command:

```
◀ CHG /EDID.EdidStatus=F48:E1
```

A Short Example of How to Use the Subscription

There are two independent users controlling the device through two independent connections (**Connection #1** and **Connection #2**). The events in the rows occur after each other.

```
▶ OPEN /MEDIA/VIDEO/QUALITY
◀ o- /MEDIA/VIDEO/QUALITY
▶ GET /MEDIA/VIDEO/Quality.QualityMode
◀ pm /MEDIA/VIDEO/QUALITY.QualityMode=graphic
▶ GET /MEDIA/VIDEO/Quality.QualityMode
◀ pm /MEDIA/VIDEO/QUALITY.QualityMode=graphic
▶ SET /MEDIA/VIDEO/Quality.QualityMode=video
◀ pw /MEDIA/VIDEO/QUALITY.QualityMode=video
◀ CHG /MEDIA/VIDEO/QUALITY.QualityMode=video
```

} Connection #1
} Connection #2
→ Connection #1

Explanation: The first user (**Connection #1**) set a subscription to a node. Later the other user (**Connection #2**) made a change, and thanks for the subscription, the first user got a notification about the change.

7.2.10. Legend for the Control Commands

Format	Description
<in>	Input port number
<out>	Output port number
<port>	Input or output port number
<loc>	Location number
<parameter>	Variable, which is defined and described in the command
<expression>	Batched parameters: the underline means that more expressions or parameters can be placed by using a semicolon, e.g. <u>I2;I4;I5</u> or <u>F27:E1;F47:E2</u>
▶	Sent command
◀	Received response
.	Space character

7.3. System Commands

7.3.1. Query the Product Name

The name of the product is a read-only parameter and cannot be modified.

Command and Response

- ▶ GET /.ProductName
- ◀ pr /.ProductName=<product_name>

Example

- ▶ GET /.ProductName
- ◀ pr /.ProductName=UMX-TPS-TX140-Plus

7.3.2. Set the Device Label

ATTENTION! The device label can be changed to a custom text in the [Status](#) tab of the LDC software. This writable parameter is not the same as the ProductName parameter. *#devicelabel*

Command and Response

- ▶ SET /MANAGEMENT/UID.DeviceLabel=<Custom_name>
- ◀ pw /MANAGEMENT/UID.DeviceLabel=<Custom_name>

The Device Label can be 39 character length and ASCII characters are allowed. Longer names are truncated.

Example

- ▶ SET /MANAGEMENT/UID.DeviceLabel=UMX-TPS_Control_room
- ◀ pw /MANAGEMENT/UID.DeviceLabel=UMX-TPS_Control_room

7.3.3. Query the Serial Number

Command and Response

- ▶ GET /.SerialNumber
- ◀ pr /.SerialNumber=<serial_nr>

Example

- ▶ GET /.SerialNumber
- ◀ pr /.SerialNumber=87654321

7.3.4. Query the Firmware Version

Command and Response *#firmwareversion*

- ▶ GET /SYS/MB.FirmwareVersion
- ◀ pr /SYS/MB.FirmwareVersion=<firmware_version>

Example

- ▶ GET /SYS/MB.FirmwareVersion
- ◀ pr /SYS/MB.FirmwareVersion=1.3.2b1 r43

7.3.5. Resetting the Device

The transmitter can be restarted – the current connections (LAN, RS-232) will be terminated.

Command and Response *#reboot #reset #restart*

- ▶ CALL /SYS:reset()
- ◀ m0 /SYS:reset=

Example

- ▶ CALL /SYS:reset()
- ◀ m0 /SYS:reset=

7.3.6. Restore the Factory Default Settings

Command and Response *#factorydefaults*

- ▶ CALL /SYS:factoryDefaults()
- ◀ m0 /SYS:factoryDefaults=

Example

- ▶ CALL /SYS:factoryDefaults()
- ◀ m0 /SYS:factoryDefaults=

The device is restarted, current connections are terminated, and the default settings are restored. See the complete list in the [Factory Default Settings](#) section.

7.3.7. Lock the Front Panel Buttons

Command and Response *#frontpanel #controllock #button*

- ▶ SET /MANAGEMENT/UI.ControlLock=<lock_status>
- ◀ pw /MANAGEMENT/UI.ControlLock=<lock_status>

Parameters

Identifier	Parameter description	Value	Explanation
<lock_status>	Control lock status of the front panel buttons	1	None - All functions of the front panel button are enabled.
		2	Locked - The front panel buttons are locked and they can be unlock by pressing Audio select and Show me buttons or with LW3 protocol command.
		3	Force locked - Locking and unlocking of the front panel buttons are possible only via protocol command.

Example

- ▶ SET /MANAGEMENT/UI.ControlLock=1
- ◀ pw /MANAGEMENT/UI.ControlLock=1

7.3.8. Disable the Default Function of the Front Panel Buttons

This setting makes possible to set an event with Event Manager where the Condition is pressing a button and the original function of the chosen button will not be executed.

Command and Response

- ▶ SET /MANAGEMENT/UI/BUTTONS/<btn_id>.DefaultFunctionEnable=<btn_status>
- ◀ pw /MANAGEMENT/UI/BUTTONS/<btn_id>.DefaultFunctionEnable=<btn_status>

Parameters

Identifier	Parameter description	Value	Parameter value
<btn_id>	Button identifier number	B1	Video select
		B2	Audio select
		B2	Show me button
<btn_status>	Status of the default function	Enable	The function is enabled.
		Disable	The function is disabled.

Example

- ▶ SET /MANAGEMENT/UI/BUTTONS/B1.DefaultFunctionEnable=false
- ◀ pw /MANAGEMENT/UI/BUTTONS/B1.DefaultFunctionEnable=false

7.3.9. Dark Mode

This command turns LEDs off the on the transmitter. *#darkmode*

Command and Response

- ▶ SET /MANAGEMENT/UI/DARKMODE.DarkModeEnable=<status>
- ◀ pw /MANAGEMENT/UI/DARKMODE.DarkModeEnable=<status>

Parameters

Identifier	Parameter description	Value	Explanation
<status>	Status of the dark mode	true	Dark mode is enabled.
		false	Dark mode is disabled.

Example

- ▶ SET /MANAGEMENT/UI/DARKMODE.DarkModeEnable=true
- ◀ pw /MANAGEMENT/UI/DARKMODE.DarkModeEnable=true

7.3.10. Dark Mode Delay

The LEDs on the front panel turn off after some delay time , which can be set in seconds.

Command and Response

- ▶ SET /MANAGEMENT/UI/DARKMODE.DarkModeDelay=<delay_time>
- ◀ pw /MANAGEMENT/UI/DARKMODE.DarkModeDelay=<delay_time>

Parameters

<delay_time> Delay time in seconds.

Example

- ▶ SET /MANAGEMENT/UI/DARKMODE.DarkModeDelay=10
- ◀ pw /MANAGEMENT/UI/DARKMODE.DarkModeDelay=10

7.4. Video Port Settings

INFO: Video port numbering can be found in the [Port Numbering](#) section. #status

7.4.1. Query the Status of Source Ports

Command and Response

- ▶ GET:/MEDIA/VIDEO/XP.SourcePortStatus
- ◀ pr:/MEDIA/VIDEO/XP.SourcePortStatus=<in1_state>;<in2_state>;<...>;<in#_state>

The response contains 5 ASCII characters for each port. The first character indicates the mute/lock state, the next four characters represent a 2-byte HEX code showing the current state of the input ports.

Example

- ▶ GET /MEDIA/VIDEO/XP.SourcePortStatus
- ◀ pr /MEDIA/VIDEO/XP.SourcePortStatus=M00AA;T00AF;T00AA;T00EF;T000A;T002E

Parameters

Letter (Character 1)		
	Mute state	Lock state
T	Unmuted	Unlocked
L	Unmuted	Locked
M	Muted	Unlocked
U	Muted	Locked

Letter
Byte 1
Byte 2

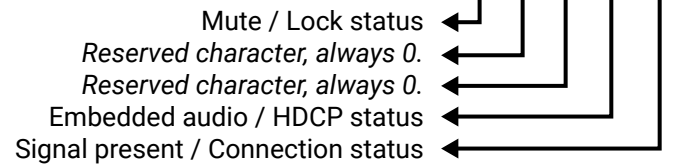

	Byte 1				Byte 2			
	Character 2		Character 3		Character 4		Character 5	
	BIT 7-6	BIT 5-4	BIT 3-2	BIT 1-0	BIT 7-6	BIT 5-4	BIT 3-2	BIT 1-0
	Reserved	Reserved	Reserved	Reserved	Embedded audio status	HDCP status	Signal present status	Connection status
00	Unknown							
01	Reserved							
10	Reserved	Reserved	Reserved	Reserved	No embedded audio	Not encrypted	No signal	Not connected
11					Embedded audio presents	Encrypted	Signal presents	Connected

The Most Common Received Port Status Responses

T00AA	T	0		0		A		A	
	Unlocked, Unmuted	00	00	00	00	10	10	10	10
		Reserved	Reserved	Reserved	Reserved	No embedded audio	Not encrypted	No signal	Not connected

T00AB	T	0		0		A		B	
	Unlocked, Unmuted	00	00	00	00	10	10	10	11
		Reserved	Reserved	Reserved	Reserved	No embedded audio	Not encrypted	No signal	Connected

T00AF	T	0		0		A		F	
	Unlocked, Unmuted	00	00	00	00	10	10	11	11
		Reserved	Reserved	Reserved	Reserved	No embedded audio	Not encrypted	Signal presents	Connected

T00EF	T	0		0		E		F	
	Unlocked, Unmuted	00	00	00	00	11	10	11	11
		Reserved	Reserved	Reserved	Reserved	Embedded audio presents	Not encrypted	Signal presents	Connected

T00BF	T	0		0		B		F	
	Unlocked, Unmuted	00	00	00	00	10	11	11	11
		Reserved	Reserved	Reserved	Reserved	No embedded audio	Encrypted	Signal presents	Connected

T00FF	T	0		0		F		F	
	Unlocked, Unmuted	00	00	00	00	11	11	11	11
		Reserved	Reserved	Reserved	Reserved	Embedded audio presents	Encrypted	Signal presents	Connected

Only for analog video ports: Character 5 is E (11 10) which means signal is present but the cable is not connected. The explanation is analog video ports have no hotplug signal which indicates the connection status.

T00EF	T	0		0		E		F	
	Unlocked, Unmuted	00	00	00	00	11	10	11	11
		Reserved	Reserved	Reserved	Reserved	Embedded audio presents	Not encrypted	Signal presents	Connected

7.4.2. Query the Status of Destination Port

Command and Response *#status*

- ▶ GET·/MEDIA/VIDEO/XP.DestinationPortStatus
- ◀ pr·/MEDIA/VIDEO/XP.DestinationPortStatus=<out1_state>;<out2_state>;<...>;<out#_state>

Parameters

<out#_state> The response contains 5 ASCII characters for each port. The first character indicates the mute/lock state, the next 2-byte long HEX code showing the current state of the output port.

Example

- ▶ GET /MEDIA/VIDEO/XP.DestinationPortStatus
- ◀ pr /MEDIA/VIDEO/XP.DestinationPortStatus=M00BF

Legend

See at previous section.

Example and Explanation

M	0		0		B		F	
Unlocked, Muted	00	00	00	00	10	11	11	11
	Reserved	Reserved	Reserved	Reserved	No embedded audio	Encrypted	Signal presents	Connected

7.4.3. Query the Video Crosspoint Setting

Command and Response

- ▶ GET·/MEDIA/VIDEO/XP.DestinationConnectionList
- ◀ pr·/MEDIA/VIDEO/XP.DestinationConnectionList=<in>

Example

- ▶ GET /MEDIA/VIDEO/XP.DestinationConnectionList
- ◀ pr /MEDIA/VIDEO/XP.DestinationConnectionList=I1

7.4.4. Disconnect Video Input

Command and Response *#crosspoint #switch*

- ▶ CALL·/MEDIA/VIDEO/XP:switch(0:01)
- ◀ mO·/MEDIA/VIDEO/XP:switch

Example

- ▶ CALL /MEDIA/VIDEO/XP:switch(0:01)
- ◀ mO /MEDIA/VIDEO/XP:switch

Input ports are disconnected from the O1 port.

7.4.5. Switching Video Input

Command and Response *#crosspoint #switch*

- ▶ CALL·/MEDIA/VIDEO/XP:switch(<in>:<out>)
- ◀ mO·/MEDIA/VIDEO/XP:switch

Example

- ▶ CALL /MEDIA/VIDEO/XP:switch(I2:O1)
- ◀ mO /MEDIA/VIDEO/XP:switch

Explanation

I2 port is connected to O1 port.

7.4.6. Query the Video Autoselect Settings

Command and Response

- ▶ GET·/MEDIA/VIDEO/XP.DestinationPortAutoselect
- ◀ pr·/MEDIA/VIDEO/XP.DestinationPortAutoselect=<out1_set>;<out2_set>;<...>;<out#_set>

The response shows the settings of each output one by one.

Parameters

Identifier	Parameter description	Value	Parameter value
<out#_set>	Two-letter code of the Autoselect settings 1 st letter	E	Autoselect is enabled.
		D	Autoselect is disabled.
<out#_set>	Two-letter code of the Autoselect settings 2 nd letter	F	First detect: the first active video input is selected.
		P	Priority detect: always the highest priority active video input will be selected.
		L	Last detect: always the last attached input is switched to the output automatically.

Example

- ▶ GET /MEDIA/VIDEO/XP.DestinationPortAutoselect
- ◀ pr /MEDIA/VIDEO/XP.DestinationPortAutoselect=EL

Explanation

EL: the Autoselect is Enabled on output, selected mode is Last detect.

INFO: For more information about the Autoselect feature see [The Autoselect Feature](#) section.

7.4.7. Change the Autoselect Mode

Command and Response *#autoselect*

- ▶ CALL /MEDIA/VIDEO/XP:setDestinationPortAutoselect(<out1_set>;<out2_set>;<...>;<out#_set>)
- ◀ mO /MEDIA/VIDEO/XP:setDestinationPortAutoselect

Parameters

See the previous section.

Example 1

- ▶ CALL /MEDIA/VIDEO/XP:setDestinationPortAutoselect(O1:EP)
- ◀ mO /MEDIA/VIDEO/XP:setDestinationPortAutoselect

The setting is changed to **EP**: Autoselect is enabled (E); the mode is set to **priority detect** (P).

Example 2

- ▶ CALL /MEDIA/VIDEO/XP:setDestinationPortAutoselect(O1:D)
- ◀ mO /MEDIA/VIDEO/XP:setDestinationPortAutoselect

The setting is changed to **DPM**: Autoselect is disabled (D). The other settings remain unchanged. Since the outputs are linked, the change will affect local and link out.

7.4.8. Query the Input Port Priority

Command and Response

- ▶ GET /MEDIA/VIDEO/XP.PortPriorityList
- ◀ pr /MEDIA/VIDEO/XP.PortPriorityList=<out1_list>;<out2_list>;<...>;<out#_list>

The response shows the priority of each output one after another. The priority number can be from 0 to 31; 0 is the highest- and 30 is the lowest priority. 31 means that the port will be skipped from the priority list.

Parameters

<out#_list> The input port priority order of the given output port: <in1>;<in2>;<...>;<in>

Example

- ▶ GET /MEDIA/VIDEO/XP.PortPriorityList
- ◀ pr /MEDIA/VIDEO/XP.PortPriorityList=0,1,2,3,4,5

Parameters

	Output					
Video input port	I1	I2	I3	I4	I5	I6
Priority	0	1	2	3	4	5

Highest priority is assigned to I1 port.

ATTENTION! The same priority number can be set to different input ports. When the priority numbers match, the input port with the lowest port number will have the highest priority.

7.4.9. Change the Input Port Priority

Command and Response

- ▶ CALL /MEDIA/VIDEO/XP:setAutoselectionPriority(<in>\(<out>\):<prio>);(<in>\(<out>\):<prio>)
- ◀ mO /MEDIA/VIDEO/XP:setAutoselectionPriority

Parameters

<prio> Priority number from 0 to 31, equal numbers are allowed (31 means that the port will be skipped from the priority list).

An input port priority can be set on an output port. Many settings can be executed by separating a semicolon (no space), see the example below.

Example

- ▶ CALL /MEDIA/VIDEO/XP:setAutoselectionPriority(I1\<O1>\:4;I2\<O1>\:4)
- ◀ mO /MEDIA/VIDEO/XP:setAutoselectionPriority

Explanation

The priority number of input 1 and Input 2 has been set to 4 on output 1. The example shows that certain control characters have been escaped: the backslash “\” character is inserted before the “(” and “)” characters. See more information about the escaping in the [Escaping](#) section.

7.4.10. Mute an Input Port

Command and Response *#mute #unmute*

- ▶ CALL /MEDIA/VIDEO/XP:muteSource(<in>)
- ◀ mO /MEDIA/VIDEO/XP:muteSource

Example

- ▶ CALL /MEDIA/VIDEO/XP:muteSource(I1)
- ◀ mO /MEDIA/VIDEO/XP:muteSource

7.4.11. Unmute an Input Port

Command and Response

- ▶ CALL /MEDIA/VIDEO/XP:unmuteSource(<in>)
- ◀ mO /MEDIA/VIDEO/XP:unmuteSource

Example

- ▶ CALL /MEDIA/VIDEO/XP:unmuteSource(I1)
- ◀ mO /MEDIA/VIDEO/XP:unmuteSource

7.4.12. Lock an Input Port

Command and Response *#mute #unmute#lock #unlock*

- ▶ CALL·/MEDIA/VIDEO/XP:lockSource(<in>)
- ◀ mO·/MEDIA/VIDEO/XP:lockSource

Example

- ▶ CALL /MEDIA/VIDEO/XP:lockSource(I1)
- ◀ mO /MEDIA/VIDEO/XP:lockSource

7.4.13. Unlock an Input Port

Command and Response

- ▶ CALL·/MEDIA/VIDEO/XP:unlockSource(<in>)
- ◀ mO·/MEDIA/VIDEO/XP:unlockSource

Example

- ▶ CALL /MEDIA/VIDEO/XP:unlockSource(I1)
- ◀ mO /MEDIA/VIDEO/XP:unlockSource

7.4.14. Mute Output

Command and Response

- ▶ CALL·/MEDIA/VIDEO/XP:muteDestination(<out>)
- ◀ mO·/MEDIA/VIDEO/XP:muteDestination

Example

- ▶ CALL /MEDIA/VIDEO/XP:muteDestination(O1)
- ◀ mO /MEDIA/VIDEO/XP:muteDestination

7.4.15. Unmute Output

Command and Response

- ▶ CALL·/MEDIA/VIDEO/XP:unmuteDestination(<out>)
- ◀ mO·/MEDIA/VIDEO/XP:unmuteDestination

Example

- ▶ CALL /MEDIA/VIDEO/XP:unmuteDestination(O1)
- ◀ mO /MEDIA/VIDEO/XP:unmuteDestination

7.4.16. Lock Output

Command and Response

- ▶ CALL·/MEDIA/VIDEO/XP:lockDestination(<out>)
- ◀ mO·/MEDIA/VIDEO/XP:lockDestination

Example

- ▶ CALL /MEDIA/VIDEO/XP:lockDestination(O1)
- ◀ mO /MEDIA/VIDEO/XP:lockDestination

7.4.17. Unlock Output

Command and Response

- ▶ CALL·/MEDIA/VIDEO/XP:unlockDestination(<out>)
- ◀ mO·/MEDIA/VIDEO/XP:unlockDestination

Example

- ▶ CALL /MEDIA/VIDEO/XP:unlockDestination(O1)
- ◀ mO /MEDIA/VIDEO/XP:unlockDestination

7.4.18. HDCP Setting (Input Port)

HDCP capability can be enabled/disabled on the input ports, thus, non-encrypted content can be seen on a non-HDCP compliant display. See more information in the [HDCP Management](#) section.

Command and Response *#hdc*

- ▶ SET·/MEDIA/VIDEO/<in>.HdcpEnable=<logical_value>
- ◀ pw·/MEDIA/VIDEO/<in>.HdcpEnable=<logical_value>

Parameters

Identifier	Parameter description	Value	Parameter value
<logical_value>	HDCP enable/disable setting	true	HDCP encryption is enabled.
		false	HDCP encryption is disabled.

Example

- ▶ SET /MEDIA/VIDEO/I2.HdcpEnable=true
- ◀ pw /MEDIA/VIDEO/I2.HdcpEnable=true

INFO: HDCP can be set for digital video inputs (I2, I3, I4) only. The function is unavailable on the analog inputs (I1, I5)

7.4.19. Test Pattern Generator Mode

The output port can send a special image towards the sink device for testing purposes. The setting is available on the input ports with the below-listed parameters.

Command and Response *#testpattern #nosyncscreen*

- ▶ SET·/MEDIA/VIDEO/<in>.FreeRunMode=<mode>
- ◀ pw·/MEDIA/VIDEO/<in>.FreeRunMode=<mode>

Parameters

Identifier	Parameter description	Value	Parameter value
<mode>	Test pattern generator mode	0	Always off: the test pattern is not displayed on the output.
		1	Always on: the test pattern is displayed on the output.
		2	Auto: the test pattern is displayed if there is no signal on the input port.

Example

- ▶ SET /MEDIA/VIDEO/I1.FreeRunMode=2
- ◀ pw /MEDIA/VIDEO/I1.FreeRunMode=2

7.4.20. Test Pattern Color

Command and Response

- ▶ SET·/MEDIA/VIDEO/<in>.FreeRunColor=<RGB_code>
- ◀ pw·/MEDIA/VIDEO/<in>.FreeRunColor=<RGB_code>

Parameters

<RGB_code> RGB color in RR;GG;BB format (separated by semicolons).

Example

- ▶ SET /MEDIA/VIDEO/I1.FreeRunColor=10;80;20
- ◀ pw /MEDIA/VIDEO/I1.FreeRunColor=10;80;20

The test pattern color is on VGA input (I1) is set to green.

7.4.21. Test Pattern Resolution

Command and Response

- ▶ SET·/MEDIA/VIDEO/<in>.FreeRunResolution=<resolution>
- ◀ pw·/MEDIA/VIDEO/<in>.FreeRunResolution=<resolution>

Parameters

Identifier	Parameter description	Value	Parameter value
		0	640x480p60
		1	720x480i60
		2	720x480p60
		3	720x576i50
		4	720x576p50
		5	800x600p60
		6	1024x768p60
		7	1280x720p60
		8	1280x1024p60
		9	1280x1080i60
		10	1920x1080p60
		11	1920x1200p60

<resolution> Applied resolution of the test pattern generator

Example

- ▶ SET /MEDIA/VIDEO/I2.FreeRunResolution=10
- ◀ pw /MEDIA/VIDEO/I2.FreeRunResolution=10

7.4.22. HDCP Setting (Output Port)

HDCP capability can be set to Auto/Always on the output ports, thus, non-encrypted content can be transmitted to a non-HDCP compliant display. See more information in the [HDCP Management](#) section.

Command and Response #hdcp

- ▶ SET /MEDIA/VIDEO/<out>.HdcpModeSetting=<HDCP_mode>
- ◀ pw /MEDIA/VIDEO/<out>.HdcpModeSetting=<HDCP_mode>

Parameters

Identifier	Parameter description	Value	Parameter value
<HDCP_mode>	HDCP mode	0	Auto
		1	Always

Example

- ▶ SET /MEDIA/VIDEO/01.HdcpModeSetting=0
- ◀ pw /MEDIA/VIDEO/01.HdcpModeSetting=0

7.4.23. HDMI Mode Settings (Output Port)

Command and Response

- ▶ SET /MEDIA/VIDEO/<out>.HdmiModeSetting=<mode>
- ◀ pw /MEDIA/VIDEO/<out>.HdmiModeSetting=<mode>

Parameters

Identifier	Parameter description	Value	Parameter value
<mode>	HDMI mode	0	Auto
		1	DVI
		2	HDMI 24 bit
		3	HDMI 30 bit
		4	HDMI 36 bit

Example

- ▶ SET /MEDIA/VIDEO/01.HdmiModeSetting=2
- ◀ pw /MEDIA/VIDEO/01.HdmiModeSetting=2

7.4.24. Color Space Setting (Output Port)

Command and Response #colorspace

- ▶ SET /MEDIA/VIDEO/<out>.ColorSpaceSetting=<colorspace>
- ◀ pw /MEDIA/VIDEO/<out>.ColorSpaceSetting=<colorspace>

Parameters

Identifier	Parameter description	Value	Parameter value
<colorspace>	Color space conversion	0	Auto
		1	RGB
		2	YCbCr 4:4:4
		3	YCbCr 4:2:2

Example

- ▶ SET /MEDIA/VIDEO/01.ColorSpaceSetting=2
- ◀ pw /MEDIA/VIDEO/01.ColorSpaceSetting=2

7.4.25. Query the Recent TPS Mode

Command and Response

- ▶ GET /REMOTE/<port>. tpsModeSetting
- ◀ pr /REMOTE/<port>. tpsModeSetting =<mode>

Parameters

Identifier	Parameter description	Value	Parameter value
<mode>	TPS mode	A	Auto
		H	HDBaseT
		L	Long reach
		1	LPPF1
		2	LPPF2

Example

- ▶ GET /REMOTE/D1.tpsModeSetting
- ◀ pr /REMOTE/D1.tpsModeSetting =H

INFO: See more information about TPS modes in the [TPS Interface](#) section.

7.4.26. TPS Mode Settings

Command and Response *#tpsmode*

- ▶ SET·/REMOTE/<port>.tpsModeSetting=<tps_mode>
- ◀ pw·/REMOTE/<port>.tpsModeSetting=<tps_mode>

Parameters

See at previous section.

Example

- ▶ SET /REMOTE/S1.tpsModeSetting=A
- ◀ pw /REMOTE/S1.tpsModeSetting=A

7.5. Audio Port Settings

INFO: Audio port numbering can be found in the [Port Numbering](#) section.

7.5.1. Query the Status of Source Ports

Command and Response *#status*

- ▶ GET·/MEDIA/AUDIO/XP.SourcePortStatus
- ◀ pr·/MEDIA/AUDIO/XP.SourcePortStatus=<in1_state>;<in2_state>;<...>; <in#_state>

The response contains 5 ASCII characters for each port. The first character indicates the mute/lock state, the next four characters represent a 2-byte HEX code showing the current state of the input ports.

Example

- ▶ GET /MEDIA/AUDIO/XP.SourcePortStatus
- ◀ pr /MEDIA/AUDIO/XP.SourcePortStatus=T000F;M000B;T000A;T000A;T000C

Legend:

Letter (Character 1)		
	Mute state	Lock state
T	Unmuted	Unlocked
L	Unmuted	Locked
M	Muted	Unlocked
U	Muted	Locked

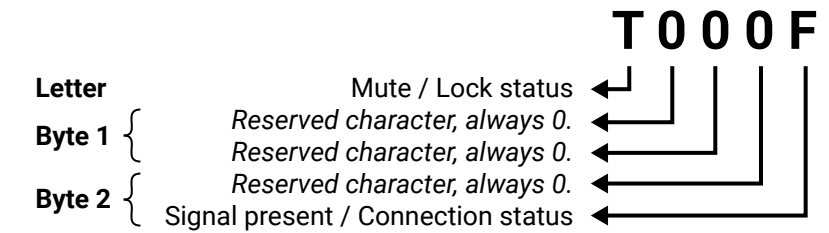

	Byte 1				Byte 2			
	Character 2		Character 3		Character 4		Character 5	
	BIT 7-6	BIT 5-4	BIT 3-2	BIT 1-0	BIT 7-6	BIT 5-4	BIT 3-2	BIT 1-0
	Reserved	Reserved	Reserved	Reserved	Reserved	Reserved	Signal present status	Connection status
0 0							Unknown	
0 1							Reserved	
1 0	Reserved	Reserved	Reserved	Reserved	Reserved	Reserved	No signal	Not connected
1 1							Signal presents	Connected

Example and Explanation (for input 2, M000B):

M	0		0		0		B	
Unlocked, Muted	00	00	00	00	00	00	10	11
	Reserved	Reserved	Reserved	Reserved	Reserved	Reserved	No signal	Connected

The Most Common Received Port Status Responses

T000A	T	0		0		0		A	
Unlocked, Unmuted	00	00	00	00	00	00	00	10	10
	Reserved	Reserved	Reserved	Reserved	Reserved	Reserved	Reserved	No signal	Not connected

T000B	T	0		0		0		B	
Unlocked, Unmuted	00	00	00	00	00	00	00	10	11
	Reserved	Reserved	Reserved	Reserved	Reserved	Reserved	Reserved	No signal	Connected

T000F	T	0		0		0		F	
Unlocked, Unmuted	00	00	00	00	00	00	00	11	11
	Reserved	Reserved	Reserved	Reserved	Reserved	Reserved	Reserved	Signal presents	Connected

Only for Phoenix audio port: Character 5 is C (11 00) which means signal is present but the cable connection status is unknown. The explanation is Phoenix connector has no pin which can indicate the connection status so this is always unknown.

T000C	T	0		0		0		C	
Unlocked, Unmuted	00	00	00	00	00	00	00	11	00
	Reserved	Reserved	Reserved	Reserved	Reserved	Reserved	Reserved	Signal presents	Unknown

7.5.2. Query the Status of Destination Port**Command and Response**

- ▶ GET /MEDIA/AUDIO/XP.DestinationPortStatus
- ◀ pr /MEDIA/AUDIO/XP.DestinationPortStatus=<out1_state>

The response contains 5 ASCII characters for each port. The first character indicates the mute/lock state, the next 2-byte long HEX code showing the current state of the output port.

Example

- ▶ GET /MEDIA/AUDIO/XP.DestinationPortStatus
- ◀ pr /MEDIA/AUDIO/XP.DestinationPortStatus=T000F

Legend

See at previous section.

Example and Explanation

T	0		0		0		F	
Unlocked, Unmuted	00	00	00	00	00	00	11	11
	Reserved	Reserved	Reserved	Reserved	Reserved	Reserved	Signal presents	Connected

7.5.3. Query the Audio Crosspoint Setting**Command and Response**

- ▶ GET /MEDIA/AUDIO/XP.DestinationConnectionList
- ◀ pr /MEDIA/AUDIO/XP.DestinationConnectionList=<in>

Example

- ▶ GET /MEDIA/AUDIO/XP.DestinationConnectionList
- ◀ pr /MEDIA/AUDIO/XP.DestinationConnectionList=I5

I5 input port is connected to the output port.

7.5.4. Switching Audio Input**Command and Response #audio**

- ▶ CALL /MEDIA/AUDIO/XP:switch(<in>:<out>)
- ◀ mO /MEDIA/AUDIO/XP:switch

Example

- ▶ CALL /MEDIA/AUDIO/XP:switch(I2:O1)
- ◀ mO /MEDIA/AUDIO/XP:switch

7.5.5. Query the Audio Autoselect Settings

Command and Response

- ▶ GET /MEDIA/AUDIO/XP.DestinationPortAutoselect
- ◀ pr /MEDIA/AUDIO/XP.DestinationPortAutoselect=<out_set>

The response shows the settings of each output one by one.

Parameters

Identifier	Parameter description	Value	Parameter value
<out_set>	Two-letter code of the Autoselect settings 1 st letter	E	Autoselect is enabled.
		D	Autoselect is disabled.
		F	First detect: the first active audio input is selected.
	Two-letter code of the Autoselect settings 2 nd letter	P	Priority detect: always the highest priority active audio input will be selected.
		L	Last detect: always the last attached input is switched to the output automatically.
		S	Static: the audio input follows the selected video if the video signal contains embedded audio.

Example

- ▶ GET /MEDIA/AUDIO/XP.DestinationPortAutoselect
- ◀ pr /MEDIA/AUDIO/XP.DestinationPortAutoselect=EL

Explanation

EL: the Autoselect is Enabled on output, selected mode is Last detect.

INFO: For more information about the Autoselect feature see [The Autoselect Feature](#) section.

7.5.6. Change the Autoselect Mode

Command and Response #audio

- ▶ CALL /MEDIA/AUDIO/XP:setDestinationPortAutoselect(<out>:<out_set>)
- ◀ mO /MEDIA/AUDIO/XP.setDestinationPortAutoselect

Parameters

See at previous section.

Example 1

- ▶ CALL /MEDIA/AUDIO/XP:setDestinationPortAutoselect(O1:EL)
- ◀ mO /MEDIA/AUDIO/XP:setDestinationPortAutoselect

The setting is changed to **EPM**: Autoselect is enabled (**E**); the mode is set to **Priority detect (P)**, and the port will be disconnected if a higher priority port becomes active (**M**).

Example 2

- ▶ CALL /MEDIA/AUDIO/XP:setDestinationPortAutoselect(O1:D)
- ◀ mO /MEDIA/AUDIO/XP:setDestinationPortAutoselect

The setting is changed to **DPM** Autoselect is disabled (**D**). The other settings remain unchanged. Since the outputs are linked, the change will affect local and link out.

INFO: For more information about the Autoselect feature see [The Autoselect Feature](#) section.

7.5.7. Query the Input Port Priority

Command and Response

- ▶ GET /MEDIA/AUDIO/XP.PortPriorityList
- ◀ pr /MEDIA/AUDIO/XP.PortPriorityList=<out1_list>;<out2_list>;<...>;<out#_list>

The response shows the priority of each output one after another. The priority number can be from 0 to 31; 0 is the highest- and 30 is the lowest priority. 31 means that the port will be skipped from the priority list.

Parameters

<out1_list> The input port priority order of the given output port: <in1>,<in2>,...,<in>

Example

- ▶ GET /MEDIA/AUDIO/XP.PortPriorityList
- ◀ pr /MEDIA/AUDIO/XP.PortPriorityList=0,1,2,3,4,5

	Output					
Video input port	I1	I2	I3	I4	I5	I6
Priority	0	1	2	3	4	5

Highest priority is assigned to I1 port.

ATTENTION! The same priority number can be set to different input ports. When the priority numbers match, the input port with the lowest port number will have the highest priority.

7.5.8. Change the Input Port Priority

Command and Response #audio

- ▶ CALL /MEDIA/AUDIO/XP:setAutoselectionPriority(<in>\(<out>\):<prio>);(<in>\(<out>\):<prio>)
- ◀ mO /MEDIA/AUDIO/XP:setAutoselectionPriority

Parameters

<prio> Priority number from 0 to 31, equal numbers are allowed (31 means that the port will be skipped from the priority list).

An input port priority can be set on an output port. Many settings can be executed by separating a semicolon (no space), see the example below.

Example

- ▶ CALL /MEDIA/VIDEO/XP:setAutoselectionPriority(I1\ (O1\):4;I2\ (O1\):4)
- ◀ mO /MEDIA/VIDEO/XP:setAutoselectionPriority

The priority number of input 1 and Input 2 has been set to 4 on output 1. The example shows that certain control characters have been escaped: the backslash “\” character is inserted before the “(” and “)” characters. See more information about the escaping in the [Escaping](#) section.

7.5.9. Mute an Audio Input

Command and Response #audio #mute

- ▶ CALL /MEDIA/AUDIO/XP:muteSource(<in>)
- ◀ mO /MEDIA/AUDIO/XP:muteSource

Example

- ▶ CALL /MEDIA/AUDIO/XP:muteSource(I1;I3)
- ◀ mO /MEDIA/AUDIO/XP:muteSource

7.5.10. Unmute an Audio Input

Command and Response #audio #unmute

- ▶ CALL /MEDIA/AUDIO/XP:unmuteSource(<in>)
- ◀ mO /MEDIA/AUDIO/XP:unmuteSource

Example

- ▶ CALL /MEDIA/AUDIO/XP:unmuteSource(I1;I2)
- ◀ mO /MEDIA/AUDIO/XP:unmuteSource

7.5.11. Lock an Input Port

Command and Response #audio #lock

- ▶ CALL /MEDIA/AUDIO/XP:lockSource(<in>)
- ◀ mO /MEDIA/AUDIO/XP:lockSource

Example

- ▶ CALL /MEDIA/AUDIO/XP:lockSource(I2;I4)
- ◀ mO /MEDIA/AUDIO/XP:lockSource

7.5.12. Unlock an Input Port

Command and Response #audio #unlock

- ▶ CALL /MEDIA/AUDIO/XP:unlockSource(<in>)
- ◀ mO /MEDIA/AUDIO/XP:unlockSource

Example

- ▶ CALL /MEDIA/AUDIO/XP:unlockSource(I1;I4)
- ◀ mO /MEDIA/AUDIO/XP:unlockSource

7.5.13. Mute Audio Output

Command and Response *#audio #mute*

- ▶ CALL·/MEDIA/AUDIO/XP:muteDestination(<out>)
- ◀ mO·/MEDIA/AUDIO/XP:muteDestination

Example

- ▶ CALL /MEDIA/AUDIO/XP:muteDestination(01)
- ◀ mO /MEDIA/AUDIO/XP:muteDestination

7.5.14. Unmute Audio Output

Command and Response *#unmute*

- ▶ CALL·/MEDIA/AUDIO/XP:unmuteDestination(<out>)
- ◀ mO·/MEDIA/AUDIO/XP:unmuteDestination

Example

- ▶ CALL /MEDIA/AUDIO/XP:unmuteDestination(01)
- ◀ mO /MEDIA/AUDIO/XP:unmuteDestination

7.5.15. Lock Output

Command and Response *#lock*

- ▶ CALL·/MEDIA/AUDIO/XP:lockDestination(<out>)
- ◀ mO·/MEDIA/AUDIO/XP:lockDestination

Example

- ▶ CALL /MEDIA/AUDIO/XP:lockDestination(01)
- ◀ mO /MEDIA/AUDIO/XP:lockDestination

7.5.16. Unlock Output

Command and Response *#unlock*

- ▶ CALL·/MEDIA/AUDIO/XP:unlockDestination(<out>)
- ◀ mO·/MEDIA/AUDIO/XP:unlockDestination

Example

- ▶ CALL /MEDIA/AUDIO/XP:unlockDestination(01)
- ◀ mO /MEDIA/AUDIO/XP:unlockDestination

7.6. Analog Audio Input Level Settings

7.6.1. Volume

Command and Response *#analogaudio #volume*

- ▶ SET·/MEDIA/AUDIO/<in>.Volume=<level>
- ◀ pw·/MEDIA/AUDIO/<in>.Volume=<level>

Parameters

- <level> Sets the input volume (attenuation) between -95.625 dB and 0 dB in step of -0.375 dB. The value is rounded up if necessary to match with the step value.

Example

- ▶ SET /MEDIA/AUDIO/I1.Volume=-15
- ◀ pw /MEDIA/AUDIO/I1.Volume=-15.000

7.6.2. Balance

Command and Response *#analogaudio #balance*

- ▶ SET·/MEDIA/AUDIO/<in>.Balance=<level>
- ◀ pw·/MEDIA/AUDIO/<in>.Balance=<level>

Parameters

- <level> Sets the balance; 0 means left balance, 100 means right balance, step is 1. Center is 50 (default).

Example

- ▶ SET /MEDIA/AUDIO/I5.Balance=75
- ◀ pw /MEDIA/AUDIO/I5.Balance=75

Explanation

The balance level of the right audio sink is set to 75%, the left one is set to 25%.

7.7. Network Configuration

7.7.1. Query the DHCP State

Command and Response *#network #dhcp #ipaddress*

- ▶ GET /MANAGEMENT/NETWORK.DhcpEnabled
- ◀ pw /MANAGEMENT/NETWORK.DhcpEnabled=<logical_value>

Parameters

Identifier	Parameter description	Value	Parameter value
<logical_value>	DHCP (dynamic IP address) setting	true	Dynamic IP address is set.
		false	Fix IP address is set.

Example

- ▶ GET /MANAGEMENT/NETWORK.DhcpEnabled
- ◀ pw /MANAGEMENT/NETWORK.DhcpEnabled=true

7.7.2. Change the DHCP State

Command and Response

- ▶ SET /MANAGEMENT/NETWORK.DhcpEnabled=<logical_value>
- ◀ pw /MANAGEMENT/NETWORK.DhcpEnabled=<logical_value>

Parameters

See the previous section.

Example

- ▶ SET /MANAGEMENT/NETWORK.DhcpEnabled=false
- ◀ pw /MANAGEMENT/NETWORK.DhcpEnabled=false

7.7.3. Query the IP Address

Command and Response

- ▶ GET /MANAGEMENT/NETWORK.IpAddress
- ◀ pr /MANAGEMENT/NETWORK.IpAddress=<IP_Address>

Example

- ▶ GET /MANAGEMENT/NETWORK.IpAddress
- ◀ pr /MANAGEMENT/NETWORK.IpAddress=192.168.0.100

7.7.4. Change the IP Address (Static)

Command and Response

- ▶ SET /MANAGEMENT/NETWORK.StaticIpAddress=<IP_address>
- ◀ pw /MANAGEMENT/NETWORK.StaticIpAddress=<IP_address>

Example

- ▶ SET /MANAGEMENT/NETWORK.StaticIpAddress=192.168.0.85
- ◀ pw /MANAGEMENT/NETWORK.StaticIpAddress=192.168.0.85

7.7.5. Query the Subnet Mask

Command and Response

- ▶ GET /MANAGEMENT/NETWORK.NetworkMask
- ◀ pr /MANAGEMENT/NETWORK.NetworkMask=<netmask>

Example

- ▶ GET /MANAGEMENT/NETWORK.NetworkMask
- ◀ pr /MANAGEMENT/NETWORK.NetworkMask=255.255.255.0

7.7.6. Change the Subnet Mask (Static)

Command and Response

- ▶ SET /MANAGEMENT/NETWORK.StaticNetworkMask=<netmask>
- ◀ pw /MANAGEMENT/NETWORK.StaticNetworkMask=<netmask>

Example

- ▶ SET /MANAGEMENT/NETWORK.StaticNetworkMask=255.255.255.0
- ◀ pw /MANAGEMENT/NETWORK.StaticNetworkMask=255.255.255.0

7.7.7. Query the Gateway Address

Command and Response

- ▶ GET /MANAGEMENT/NETWORK.GatewayAddress
- ◀ pr /MANAGEMENT/NETWORK.GatewayAddress=<gw_address>

Example

- ▶ GET /MANAGEMENT/NETWORK.GatewayAddress
- ◀ pr /MANAGEMENT/NETWORK.GatewayAddress=192.168.0.1

7.7.8. Change the Gateway Address (Static)

Command and Response

- ▶ SET /MANAGEMENT/NETWORK.StaticGatewayAddress=<gw_address>
- ◀ pw /MANAGEMENT/NETWORK.StaticGatewayAddress=<gw_address>

Example

- ▶ SET /MANAGEMENT/NETWORK.StaticGatewayAddress=192.168.0.5
- ◀ pw /MANAGEMENT/NETWORK.StaticGatewayAddress=192.168.0.5

7.8. RS-232 Port Configuration

INFO: Serial port numbering can be found in the [Port Numbering](#) section.

7.8.1. Protocol Setting

Command and Response *#rs232 #rs-232 #serial #controlprotocol*

- ▶ SET /MEDIA/UART/<port>.ControlProtocol=<protocol>
- ◀ pw /MEDIA/UART/<port>.ControlProtocol=<protocol>

Parameters

Identifier	Parameter description	Value	Parameter value
<protocol>	Control protocol which is applied on the selected serial port	0	LW2 protocol
		1	LW3 protocol

Example

- ▶ SET /MEDIA/UART/P1.ControlProtocol=1
- ◀ pw /MEDIA/UART/P1.ControlProtocol=1

7.8.2. BAUD Rate Setting

Command and Response

- ▶ SET /MEDIA/UART/<port>.Baudrate=<baudrate>
- ◀ pw /MEDIA/UART/<port>.Baudrate=<baudrate>

Parameters

Identifier	Parameter description	Value	Parameter value
<baudrate>	BAUD rate value	0	4800
		1	7200
		2	9600
		3	14400
		4	19200
		5	38400
		6	57600
		7	115200

Example

- ▶ SET /MEDIA/UART/P1.Baudrate=2
- ◀ pw /MEDIA/UART/P1.Baudrate=2

7.8.3. Databits Setting

Command and Response

- ▶ SET /MEDIA/UART/<port>.DataBits=<databits>
- ◀ pw /MEDIA/UART/<port>.DataBits=<databits>

Parameters

Identifier	Parameter description	Value	Parameter value
<databits>	Databits value	8	8
		9	9

Example

- ▶ SET /MEDIA/UART/P1.DataBits=8
- ◀ pw /MEDIA/UART/P1.DataBits=8

7.8.4. Stopbits Setting

Command and Response

- ▶ SET·/MEDIA/UART/<port>.StopBits=<stopbits>
- ◀ pw·/MEDIA/UART/<port>.StopBits=<stopbits>

Parameters

Identifier	Parameter description	Value	Parameter value
		0	1
<stopbits>	Stopbits value	1	1,5
		2	2

Example

- ▶ SET /MEDIA/UART/P1.StopBits=0
- ◀ pw /MEDIA/UART/P1.StopBits=0

7.8.5. Parity Setting

Command and Response

- ▶ SET·/MEDIA/UART/ <port>.Parity=<parity>
- ◀ pw·/MEDIA/UART/<port>.Parity=<parity>

Parameters

Identifier	Parameter description	Value	Parameter value
		0	None
<parity>	Parity setting	1	Odd
		2	Even

Example

- ▶ SET /MEDIA/UART/P1.Parity=0
- ◀ pw /MEDIA/UART/P1.Parity=0

7.8.6. RS-232 Operation Mode

Command and Response *#rs232 #rs-232 #serial #commandinjection*

- ▶ SET·/MEDIA/UART/<port>.Rs232Mode=<mode>
- ◀ pw·/MEDIA/UART/<port>.Rs232Mode=<mode>

Parameters

Identifier	Parameter description	Value	Parameter value
		0	Pass-through
<stopbits>	Stopbits value	1	Control
		2	Command injection

Example

- ▶ SET /MEDIA/UART/P1.Rs232Mode=1
- ◀ pw /MEDIA/UART/P1.Rs232Mode=1

INFO: See more information about RS-232 modes in the [Technical Background](#) section.

7.8.7. Command Injection Enable

Command and Response

- ▶ SET·/MEDIA/UART/<port>.CommandInjectionEnable=<logical_value>
- ◀ pw·/MEDIA/UART/<port>.CommandInjectionEnable=<logical_value>

Parameters

Identifier	Parameter description	Value	Parameter value
<logical_value>	Command injection enable/disable setting	true	Command injection is enabled.
		false	Command injection is disabled.

Example

- ▶ SET /MEDIA/UART/P1.CommandInjectionEnable=true
- ◀ pw /MEDIA/UART/P1.CommandInjectionEnable=true

INFO: The Command injection status is stored in another read-only property: /MEDIA/UART/<serial_port>.CommandInjectionStatus.

7.9. RS-232 Recognizer

DIFFERENCE: This feature is available only in UMX-TPS-TX140K, UMX-TPS-TX140-Plus and WP-UMX-TPS-TX130-US models.

This tool is able to recognize the incoming RS-232 message. It stores the incoming serial data from the first bit, until the previously defined string (delimiter) or the elapsing timeout after the last bit. The last incoming serial string is saved in different formats (string, hex, and hash).

#rs232 #rs-232 #serial

7.9.1. Enable the Recognizer

- ▶ SET /MEDIA/UART/<port>.RecognizerEnable=<logical_value>
- ◀ pw /MEDIA/UART/<port>.RecognizerEnable=<logical_value>

Parameters

Identifier	Parameter description	Value	Parameter value
<logical_value>	Recognizer enable/disable setting	true false	Enabled Disabled

Example

- ▶ SET /MEDIA/UART/P1.RecognizerEnable=true
- ◀ pw /MEDIA/UART/P1.RecognizerEnable=true

7.9.2. Set the Delimiter Hex

When the delimiter hex string is detected in the incoming serial data, the device saves the RS-232 message data from the first bit, until the delimiter (or the data between the two delimiter).



- ▶ SET /MEDIA/UART/RECOGNIZER.DelimiterHex=<delimiter>
- ◀ pw /MEDIA/UART/RECOGNIZER.DelimiterHex=<delimiter>

Parameters

<delimiter> It can be max. 8-character long (or 16 hex digit) in hex format.

Example

- ▶ SET /MEDIA/UART/RECOGNIZER.DelimiterHex=3a
- ◀ pw /MEDIA/UART/RECOGNIZER.DelimiterHex=3a

7.9.3. Set the Timeout

When the set time is elapsed after the last received message, the device saves the data. It can be applied, when there is no special or easily defined delimiter string in the incoming serial data, but there is a time gap between the messages.

- ▶ SET /MEDIA/UART/RECOGNIZER.Timeout=<timeout>
- ◀ pw /MEDIA/UART/RECOGNIZER.Timeout=<timeout>

Parameters

<timeout> Timeout value in ms.; 0: disable the timeout; minimum value: 10.

Example

- ▶ SET /MEDIA/UART/RECOGNIZER.Timeout=20
- ◀ pw /MEDIA/UART/RECOGNIZER.Timeout=20

7.9.4. Query the Last Recognized Serial Message in String Format

The recognized data is stored in string format. They are stored until the next incoming message or until the RECOGNIZER:clear() method is called.

TIPS AND TRICKS: When one of these properties are set as a condition in the Event Manager, and the same strings follow each other, the action **will execute once**.

Command and Response

- ▶ GET /MEDIA/UART/RECOGNIZER.Rx
- ◀ pr /MEDIA/UART/RECOGNIZER.Rx=<recognized_string>

Parameters

<recognized_string> Max. 12 byte-long recognized data string.

Example

- ▶ GET /MEDIA/UART/RECOGNIZER.Rx
- ◀ pr /MEDIA/UART/RECOGNIZER.Rx=Login:

7.9.5. Query the Last Recognized Serial Message in Hex Format

The recognized data is stored in hex format. They are stored until the next incoming message or until the RECOGNIZER:clear() method is called.

TIPS AND TRICKS: When one of these properties are set as a condition in the Event Manager, and the same strings follow each other, the action **will execute once**.

Command and Response

- ▶ GET /MEDIA/UART/RECOGNIZER.RxHex
- ◀ pr /MEDIA/UART/RECOGNIZER.RxHex=<recognized_hex>

Parameters

<recognized_hex> Recognized data in hex format.

Example

- ▶ GET /MEDIA/UART/RECOGNIZER.RxHex
- ◀ pr /MEDIA/UART/RECOGNIZER.RxHex=FF1F4C6F67696E3A

7.9.6. Query the Last Recognized Serial Message in Hash Format

The recognized data is stored in hash format. They are stored until the next incoming message or until the RECOGNIZER:clear() method is called.

TIPS AND TRICKS: When one of these properties are set as a condition in the Event Manager, and the same strings follow each other, the action **will execute once**.

Command and Response

- ▶ GET /MEDIA/UART/RECOGNIZER.Hash
- ◀ pr /MEDIA/UART/RECOGNIZER.Hash=<recognized_hash>

Parameters

<recognized_hash> Fingerprint code, Max. 32 bit-long recognized data hash.

Example

- ▶ GET /MEDIA/UART/RECOGNIZER.Hash
- ◀ pr /MEDIA/UART/RECOGNIZER.Hash=997A659E

7.9.7. Clear the Stored Last Recognized Serial Message

This method deletes all the stored received serial messages.

Command and Response

- ▶ CALL·/MEDIA/UART/RECOGNIZER:clear()
- ◀ mO·/MEDIA/UART/RECOGNIZER:clear

Example

- ▶ CALL /MEDIA/UART/RECOGNIZER:clear()
- ◀ mO /MEDIA/UART/RECOGNIZER:clear

7.9.8. Query the Last Recognized Serial Message in String Format

The recognized data is stored in string, hex and hash format in a **temporary** storage. They are erased when the Active Timeout elapsed.

TIPS AND TRICKS: When these properties are set as a condition in the Event Manager, and the same strings follow each other, the action **will execute every occasion** if the active timeout set properly.

Command and Response

- ▶ GET·/MEDIA/UART/RECOGNIZER.ActiveRx
- ◀ pr·/MEDIA/UART/RECOGNIZER.ActiveRx=<recognized _string>

Parameters

<recognized _string> Max. 12 byte-long recognized data string.

Example

- ▶ GET /MEDIA/UART/RECOGNIZER.ActiveRx
- ◀ pr /MEDIA/UART/RECOGNIZER.ActiveRx=Login:

7.9.9. Query the Last Recognized Serial Message in Hex Format

The recognized data is stored in string, hex and hash format in a **temporary** storage. They are erased when the Active Timeout elapsed.

TIPS AND TRICKS: When these properties are set as a condition in the Event Manager, and the same strings follow each other, the action **will execute every occasion** if the active timeout set properly.

Command and Response

- ▶ GET·/MEDIA/UART/RECOGNIZER.ActiveRxHex
- ◀ pr·/MEDIA/UART/RECOGNIZER.ActiveRxHex=<recognized _hex>

Parameters

<recognized _hex> Recognized data in hex format.

Example

- ▶ GET /MEDIA/UART/RECOGNIZER.ActiveRxHex
- ◀ pr /MEDIA/UART/RECOGNIZER.ActiveRxHex= 4C6F67696E3A

7.9.10. Query the Last Recognized Serial Message in Hash Format

The recognized data is stored in string, hex and hash format in a **temporary** storage. They are erased when the Active Timeout elapsed.

TIPS AND TRICKS: When these properties are set as a condition in the Event Manager, and the same strings follow each other, the action **will execute every occasion** if the active timeout set properly.

Command and Response

- ▶ GET·/MEDIA/UART/RECOGNIZER.ActiveHash
- ◀ pr·/MEDIA/UART/RECOGNIZER.ActiveHash=<recognized _hash>

Parameters

<recognized _hash> Fingerprint code, Max. 32 bit-long recognized data hash.

Example

- ▶ GET /MEDIA/UART/RECOGNIZER.ActiveHash
- ◀ pr /MEDIA/UART/RECOGNIZER.ActiveHash= 2D8A5E38

7.9.11. Set the Active Timeout

This property is responsible for erasing the temporary storage (ActiveRx, ActiveRxHex, ActiveHash) after the elapsing time. Default value is 50ms.

Command and Response

- ▶ SET·/MEDIA/UART/RECOGNIZER.ActivePropertyTimeout=<a_timeout>
- ◀ pw·/MEDIA/UART/RECOGNIZER.ActivePropertyTimeout=<a_timeout>

Parameters

<a_timeout> Active timeout value (ms) between 0 and 255.

Example

- ▶ SET /MEDIA/UART/RECOGNIZER.ActivePropertyTimeout=255
- ◀ pw /MEDIA/UART/RECOGNIZER.ActivePropertyTimeout=255

7.10. Infrared Port Configuration

INFO: Infrared input and output port numbering can be found in the [Port Numbering](#) section.

7.10.1. Enable Command Injection Mode

Command and Response *#commandinjection*

- ▶ SET·/MEDIA/IR/<port>.CommandInjectionEnable=true|false
- ◀ pw·/MEDIA/IR/<port>.CommandInjectionEnable=true|false

Example

- ▶ SET /MEDIA/IR/S1.CommandInjectionEnable=true
- ◀ pw /MEDIA/IR/S1.CommandInjectionEnable=true

7.10.2. Enable/Disable Output Signal Modulation

Command and Response

- ▶ SET·/MEDIA/IR/<port>.EnableModulation=true|false
- ◀ pw·/MEDIA/IR/<port>.EnableModulation=true|false

Example

- ▶ SET /MEDIA/IR/D1.EnableModulation=false
- ◀ pw /MEDIA/IR/D1.EnableModulation=false

Signal modulation is turned off on IR output (D1).

INFO: The default setting value is "true" (enabled).

7.11. Sending Message via the Communication Ports

7.11.1. Sending a TCP Message (ASCII-format) via TCP Port

The command is for sending a command message in ASCII-format. This method allows escaping the control characters. For more information see the [Escaping](#) section.

Command and Response

- ▶ CALL /MEDIA/ETHERNET:tcpMessage(<IP_address>:<port_no>=<message>)
- ◀ mO /MEDIA/ETHERNET:tcpMessage

Example

- ▶ CALL /MEDIA/ETHERNET:tcpMessage(192.168.0.103:6107=C00)
- ◀ mO /MEDIA/ETHERNET:tcpMessage

The 'C00' message is sent to the indicated IP:port address.

Example with HEX codes

- ▶ CALL /MEDIA/ETHERNET:tcpMessage(192.168.0.20:5555=C00\x0a\x0d)
- ◀ mO /MEDIA/ETHERNET:tcpMessage

The 'C00' message with CrLf (Carriage return and Line feed) is sent to the indicated IP:port address. The \x sequence indicates the HEXA code; see more information in the [Using Hexadecimal Codes](#) section.

7.11.2. Sending a TCP Text (ASCII-format) via TCP Port

The command is for sending a text message in ASCII-format. This method **does not allow** escaping or inserting control characters.

Command and Response

- ▶ CALL /MEDIA/ETHERNET:tcpText(<IP_address>:<port_no>=<text>)
- ◀ mO /MEDIA/ETHERNET:tcpText

Example

- ▶ CALL /MEDIA/ETHERNET:tcpText(192.168.0.103:6107=pwr_on)
- ◀ mO /MEDIA/ETHERNET:tcpText

Explanation

The 'pwr_on' text is sent to the indicated IP:port address.

7.11.3. Sending a TCP Binary Message (HEX-format) via TCP Port

The command is for sending a binary message in Hexadecimal format. This method **does not allow** escaping or inserting control characters.

Command and Response

- ▶ CALL /MEDIA/ETHERNET:tcpBinary(<IP_address>:<port_no>=<HEX_message>)
- ◀ mO /MEDIA/ETHERNET:tcpBinary

Example

- ▶ CALL /MEDIA/ETHERNET:tcpBinary(192.168.0.103:6107=0100000061620000cdcc2c40)
- ◀ mO /MEDIA/ETHERNET:tcpBinary

Explanation

The '0100000061620000cdcc2c40' message is sent to the indicated IP:port address.

INFO: There is no need to insert a space or other separator character between the binary messages.

7.11.4. Sending UDP Message (ASCII-format) via TCP Port

The command is for sending a UDP message in ASCII-format. This method allows escaping the control characters. For more information see the [Escaping](#) section.

Command and Response

- ▶ CALL /MEDIA/ETHERNET:udpMessage(<IP_address>:<port_no>=<message>)
- ◀ mO /MEDIA/ETHERNET:udpMessage

Example

- ▶ CALL /MEDIA/ETHERNET:udpMessage(192.168.0.103:6107=C00)
- ◀ mO /MEDIA/ETHERNET:udpMessage

The 'C00' message is sent to the indicated IP:port address.

Example with HEX codes

- ▶ CALL /MEDIA/ETHERNET:udpMessage(192.168.0.20:9988=C00\x0a\x0d)
- ◀ mO /MEDIA/ETHERNET:udpMessage

The 'C00' message with CrLf (Carriage return and Line feed) is sent to the indicated IP:port address. The \x sequence indicates the HEXA code; see more information in the [Using Hexadecimal Codes](#) section.

7.11.5. Sending a TCP Text (ASCII-format) via TCP Port

The command is for sending a text message in ASCII-format via UDP-protocol. This method **does not allow** escaping or inserting control characters.

Command and Response

- ▶ CALL /MEDIA/ETHERNET:udpText(<IP_address>:<port_no>=<text>)
- ◀ mO /MEDIA/ETHERNET:udpText

Example

- ▶ CALL /MEDIA/ETHERNET:udpText(192.168.0.20:9988=open)
- ◀ mO /MEDIA/ETHERNET:udpText

The 'open' text is sent to the indicated IP:port address.

7.11.6. Sending a UDP Binary Message (HEX-format) via TCP Port

The command is for sending a binary message in Hexadecimal format via UDP protocol. This method **does not allow** escaping or inserting control characters.

Command and Response

- ▶ CALL /MEDIA/ETHERNET:udpBinary(<IP_address>:<port_no>=<HEX_message>)
- ◀ mO /MEDIA/ETHERNET:udpBinary

Example

- ▶ CALL /MEDIA/ETHERNET:udpBinary(192.168.0.20:9988=433030)
- ◀ mO /MEDIA/ETHERNET:udpBinary

The '433030' message is sent to the indicated IP:port address.

■ INFO: There is no need to insert a space or other separator character between the binary messages.

7.11.7. Sending a Message (ASCII-format) via Serial Port

The command is for sending a command message in ASCII-format. This method **allows** escaping the control characters. For more information see the [Escaping](#) section.

Command and Response

- ▶ CALL /MEDIA/UART/<port>:sendMessage(<message>)
- ◀ mO /MEDIA/UART/<port>:sendMessage

Example

- ▶ CALL /MEDIA/UART/P1:sendMessage(PWR0)
- ◀ mO /MEDIA/UART/P1:sendMessage

The 'PWR0' message is sent out via the P1 serial port.

7.11.8. Sending a Text (ASCII-format) via Serial Port

The command is for sending a command message in ASCII-format. This method **does not allow** escaping the control characters.

Command and Response

- ▶ CALL /MEDIA/UART/<port>:sendText(<message>)
- ◀ mO /MEDIA/UART/<port>:sendText

Example

- ▶ CALL /MEDIA/UART/P1:sendText(open)
- ◀ mO /MEDIA/UART/P1:sendText

The 'open' text is sent out via the P1 serial port.

7.11.9. Sending a Binary Message (HEX-format) via Serial Port

The command is for sending a command message in Hexadecimal-format. This method **does not allow** escaping the control characters.

Command and Response

- ▶ CALL /MEDIA/UART/<port>:sendBinaryMessage(<message>)
- ◀ mO /MEDIA/UART/<port>:sendBinaryMessage

Example

- ▶ CALL /MEDIA/UART/P1:sendBinaryMessage(433030)
- ◀ mO /MEDIA/UART/P1:sendBinaryMessage

The '433030' message is sent out via the P1 serial port.

7.11.10. Using Hexadecimal Codes

Hexadecimal codes can be inserted in the ASCII message when using:

sendMessage command: CALL /MEDIA/UART/P1:sendMessage(C00\x0D)

tcpMessage command: CALL /MEDIA/ETHERNET:tcpMessage(C00\x0D)

udpMessage command: CALL /MEDIA/ETHERNET:udpMessage(C00\x0D)

- **C00:** the message.
- **\x:** indicates that the following is a hexadecimal code.
- **0D:** the hexadecimal code (Carriage Return).

7.12. Sending CEC Commands

DIFFERENCE: CEC command sending feature is available only in UMX-TPS-TX140K, UMX-TPS-TX140-Plus and WP-UMX-TPS-TX130-US models.

INFO: The hidden first 2 bytes of the CEC command is static, it refers to the logical address of the sender and the addressee. When the port is input, it is always 04 (from TV to Playback device 1.), when the port is output, it is always 40 (from Playback device 1. to TV). Broadcast addressing is also possible (in this case it is 0F or 4F).

Parameters

Parameter	Description
<port>	HDMI input (I2) and TPS output (O1) port.

7.12.1. Sending an OSD String

Sending the OSD string consists of two steps. First, set the **CEC.OsdString** property with the desired text, after that, call the **CEC.send(set_osd)** method.

Step 1 – Setting the CEC.OsdString Property

Command and Response

- ▶ SET /MEDIA/CEC/<port>.OsdString=<text>
- ◀ pw /MEDIA/CEC/<port>.OsdString=<text>

Parameters

<text> Letters (A-Z) and (a-z), hyphen (-), underscore (_), numbers (0-9), and dot (.). Max length: 14 characters.

Example

- ▶ SET /MEDIA/CEC/I2.OsdString=Lightware
- ◀ pw /MEDIA/CEC/I2.OsdString=Lightware

Step 2 – Call the CEC.send(set_osd) method

Command and Response

- ▶ CALL /MEDIA/CEC/<port>.send(set_osd)
- ◀ mO /MEDIA/CEC/I2:send

Example

- ▶ CALL /MEDIA/CEC/I2:send(set_osd)
- ◀ mO /MEDIA/CEC/I2:send

7.12.2. Sending a CEC Command in Text Format

Command and Response #cec

- ▶ CALL /MEDIA/CEC/<port>.send(<command>)
- ◀ mO /MEDIA/CEC/<port>.send

Parameters

The followings are accepted as <command>:

image_view_on	standby	ok	back	up
down	left	right	root_menu	setup_menu
contents_menu	favorite_menu	media_top_menu	media_context_menu	number_0
number_1	number_2	number_3	number_4	number_5
number_6	number_7	number_8	number_9	dot
enter	clear	channel_up	channel_down	sound_select
input_select	display_info	power_legacy	page_up	page_down
volume_up	volume_down	mute_toggle	mute	unmute
play	stop	pause	record	rewind
fast_forward	eject	skip_forward	skip_backward	3d_mode
stop_record	pause_record	play_forward	play_reverse	select_next_media
select_media_1	select_media_2	select_media_3	select_media_4	select_media_5
power_toggle	power_on	power_off	stop_function	f1
f2	f3	f4		

Example

- ▶ CALL /MEDIA/CEC/I2:send(power_on)
- ◀ mO /MEDIA/CEC/I2:send

7.12.3. Sending a CEC Command in Hexadecimal Format

- ▶ CALL /MEDIA/CEC/<port>.sendHex(<hex_code>)
- ◀ mO /MEDIA/CEC/<port>.sendHex

Parameters

<hex_code> Accepted command is max. 30 character long (15 byte) in hexadecimal format.

Example

- ▶ CALL /MEDIA/CEC/I2:sendHex(8700E091)
- ◀ mO /MEDIA/CEC/I2:sendHex

7.13. GPIO Port Configuration

INFO: Use the GET command to query a parameter. `#gpio`

Parameters

Parameter	Description
<port>	GPIO port number (1..8). Example: P1

7.13.1. Set the Direction of a GPIO Pin

Command and Response

- ▶ SET /MEDIA/GPIO/<port>.Direction=<direction>
- ◀ pw /MEDIA/GPIO/<port>.Direction=<direction>

Parameters

Identifier	Parameter description	Value	Parameter value
<direction>	Direction of the GPIO pin	I	Input
		O	Output

Example

- ▶ SET /MEDIA/GPIO/P1.Direction=I
- ◀ pw /MEDIA/GPIO/P1.Direction=I

7.13.2. Set the Output Level of a GPIO Pin

Command and Response

- ▶ SET /MEDIA/GPIO/<port>.Output=<value>
- ◀ pw /MEDIA/GPIO/ <port>.Output=<value>

Parameters

Identifier	Parameter description	Value	Parameter value
<value>	Level value of the GPIO pin	H	Logical high level
		L	Logical low level

Example

- ▶ SET /MEDIA/GPIO/P1.Output=H
- ◀ pw /MEDIA/GPIO/P1.Output=H

7.13.3. Toggle the Level of a GPIO Pin

Command and Response

- ▶ CALL /MEDIA/GPIO/<port>.toggle()
- ◀ m0 /MEDIA/GPIO/ <port>.toggle

Example

- ▶ CALL /MEDIA/GPIO/P1.toggle()
- ◀ m0 /MEDIA/GPIO/P1.toggle

Explanation

If the direction of the pin is input: the output value is toggled. If the direction of the pin is output: the output value and the input value are toggled.

7.14. EDID Management

Parameters `#edid`

Parameter	Description
<emulated>	The emulated EDID memory of the desired input port. Example: E1.
<dynamic>	Dynamic EDID memory index. Example: D1
<user>	User EDID memory index. Example: U1
<factory>	Factory EDID memory index. Example: F1

7.14.1. Query the Emulated EDIDs

Command and Response

- ▶ GET /EDID.EdidStatus
- ◀ pr /EDID.EdidStatus=<dynamic|user|factory>:<emulated>;...:<dynamic|user|factory>:<emulated>

Example

- ▶ GET /EDID.EdidStatus
- ◀ pr /EDID.EdidStatus=D1:E1;D1:E2;D1:E3;D1:E4

Emulated EDID memory for input port is listed with the EDID number that is currently emulated on the input.

7.14.2. Query the Validity of a Dynamic EDID

Command and Response #edid

- ▶ GET·/EDID/D/<dynamic>.Validity
- ◀ pr·/EDID/D/<dynamic>.Validity=<logical_value>

Parameters

The <logical_value> can be **true** or **false**.

Example

- ▶ GET /EDID/D/D1.Validity
- ◀ pr /EDID/D/D1.Validity=true

7.14.3. Query the Preferred Resolution of an User EDID

Command and Response

- ▶ GET·/EDID/U/<user>.PreferredResolution
- ◀ pr·/EDID/U/<user>.PreferredResolution=<resolution>

Example

- ▶ GET /EDID/U/U2.PreferredResolution
- ◀ pr /EDID/U/U2.PreferredResolution=1920x1080p60.00Hz

7.14.4. Emulating an EDID to an Input Port

Command and Response

- ▶ CALL·/EDID:switch(<dynamic|user|factory>:<emulated>)
- ◀ mO·/EDID:switch

Example

- ▶ CALL /EDID:switch(F49:E2)
- ◀ mO /EDID:switch

7.14.5. Emulating an EDID to All Input Ports

Command and Response

- ▶ CALL·/EDID:switchAll(<dynamic|user|factory>)
- ◀ mO·/EDID:switchAll

Example

- ▶ CALL /EDID:switchAll(F47)
- ◀ mO /EDID:switchAll

7.14.6. Copy an EDID to User Memory

Command and Response

- ▶ CALL·/EDID:copy(<dynamic|emulated|factory|user>:<user>)
- ◀ mO·/EDID:copy

Example

- ▶ CALL /EDID:copy(D1:U1)
- ◀ mO /EDID:copy

The EDID of the last connected sink of D1 (Output 1) has been copied to U1.

7.14.7. Deleting an EDID from User Memory

Command and Response

- ▶ CALL·/EDID:delete(<user>)
- ◀ mO·/EDID:delete

Example

- ▶ CALL /EDID:delete(U1)
- ◀ mO /EDID:delete

7.14.8. Resetting the Emulated EDIDs

Command and Response

- ▶ CALL·/EDID:reset()
- ◀ mO·/EDID:reset

Example

- ▶ CALL /EDID:reset()
- ◀ mO /EDID:reset

Calling this method switches all emulated EDIDs to factory default one. See the table in the [Factory EDID List](#) section.

7.15. LW3 Commands - Quick Summary

System Commands

Query the Product Name

- ▶ GET·/.ProductName

Set the Device Label

- ▶ SET·/MANAGEMENT/UID.DeviceLabel=<Custom_name>

Query the Serial Number

- ▶ GET·/.SerialNumber

Query the Firmware Version

- ▶ GET·/SYS/MB.FirmwareVersion

Resetting the Device

- ▶ CALL·/SYS:reset()

Restore the Factory Default Settings

- ▶ CALL·/SYS:factoryDefaults()

Lock the Front Panel Buttons

- ▶ SET /MANAGEMENT/UI.ControlLock=<lock_status>

Disable the Default Function of the Front Panel Buttons

- ▶ SET /MANAGEMENT/UI/BUTTONS/<btn_id>.DefaultFunctionEnable=<btn_status>

Dark Mode

- ▶ SET /MANAGEMENT/UI/DARKMODE.DarkModeEnable=<status>

Dark Mode Delay

- ▶ SET /MANAGEMENT/UI/DARKMODE.DarkModeDelay=<delay_time>

Video Port Settings

Query the Status of Source Ports

- ▶ GET·/MEDIA/VIDEO/XP.SourcePortStatus

Query the Status of Destination Port

- ▶ GET·/MEDIA/VIDEO/XP.DestinationPortStatus

Query the Video Crosspoint Setting

- ▶ GET·/MEDIA/VIDEO/XP.DestinationConnectionList

Switching Video Input

- ▶ CALL·/MEDIA/VIDEO/XP:switch(<in>:<out>)

Query the Video Autoselect Settings

- ▶ GET·/MEDIA/VIDEO/XP.DestinationPortAutoselect

Change the Autoselect Mode

- ▶ CALL·/MEDIA/VIDEO/XP:setDestinationPortAutoselect(<out1_set>;<out2_set>;<...>;<out#_set>)

Query the Input Port Priority

- ▶ GET·/MEDIA/VIDEO/XP.PortPriorityList

Change the Input Port Priority

- ▶ CALL·/MEDIA/VIDEO/XP:setAutoselectionPriority(<in>\(<out>\):<prio>);(<in>\(<out>\):<prio>)

Mute an Input Port

- ▶ CALL·/MEDIA/VIDEO/XP:muteSource(<in>)

Unmute an Input Port

- ▶ CALL·/MEDIA/VIDEO/XP:unmuteSource(<in>)

Lock an Input Port

- ▶ CALL·/MEDIA/VIDEO/XP:lockSource(<in>)

Unlock an Input Port

- ▶ CALL·/MEDIA/VIDEO/XP:unlockSource(<in>)

Mute Output

- ▶ CALL·/MEDIA/VIDEO/XP:muteDestination(<out>)

Unmute Output

- ▶ CALL·/MEDIA/VIDEO/XP:unmuteDestination(<out>)

Lock Output

- ▶ CALL·/MEDIA/VIDEO/XP:lockDestination(<out>)

Unlock Output

- ▶ CALL·/MEDIA/VIDEO/XP:unlockDestination(<out>)

HDCP Setting (Input Port)

- ▶ SET·/MEDIA/VIDEO/<in>.HdcpEnable=<logical_value>

Test Pattern Generator Mode

- ▶ SET·/MEDIA/VIDEO/<in>.FreeRunMode=<mode>

Test Pattern Color

- ▶ SET·/MEDIA/VIDEO/<in>.FreeRunColor=<RGB_code>

Test Pattern Resolution

- ▶ SET·/MEDIA/VIDEO/<in>.FreeRunResolution=<resolution>

HDCP Setting (Output Port)

- ▶ SET:/MEDIA/VIDEO/<out>.HdcpModeSetting=<HDCP_mode>

HDMI Mode Settings (Output Port)

- ▶ SET:/MEDIA/VIDEO/<out>.HdmiModeSetting=<mode>

Color Space Setting (Output Port)

- ▶ SET:/MEDIA/VIDEO/<out>.ColorSpaceSetting=<colorspace>

Query the Recent TPS Mode

- ▶ GET:/REMOTE/<port>.tpsModeSetting

TPS Mode Settings

- ▶ SET:/REMOTE/<port>.tpsModeSetting=<tps_mode>

Audio Port Settings**Query the Status of Source Ports**

- ▶ GET:/MEDIA/AUDIO/XP.SourcePortStatus

Query the Status of Destination Port

- ▶ GET:/MEDIA/AUDIO/XP.DestinationPortStatus

Query the Audio Crosspoint Setting

- ▶ GET:/MEDIA/AUDIO/XP.DestinationConnectionList

Switching Audio Input

- ▶ CALL:/MEDIA/AUDIO/XP:switch(<in>:<out>)

Query the Audio Autoselect Settings

- ▶ GET:/MEDIA/AUDIO/XP.DestinationPortAutoselect

Change the Autoselect Mode

- ▶ CALL:/MEDIA/AUDIO/XP:setDestinationPortAutoselect(<out>:<out_set>)

Query the Input Port Priority

- ▶ GET:/MEDIA/AUDIO/XP.PortPriorityList

Change the Input Port Priority

- ▶ CALL:/MEDIA/AUDIO/XP:setAutoselectionPriority(<in>\(<out>\):<prio>);(<in>\(<out>\):<prio>)

Mute an Audio Input

- ▶ CALL:/MEDIA/AUDIO/XP:muteSource(<in>)

Unmute an Audio Input

- ▶ CALL:/MEDIA/AUDIO/XP:unmuteSource(<in>)

Lock an Input Port

- ▶ CALL:/MEDIA/AUDIO/XP:lockSource(<in>)

Unlock an Input Port

- ▶ CALL:/MEDIA/AUDIO/XP:unlockSource(<in>)

Mute Audio Output

- ▶ CALL:/MEDIA/AUDIO/XP:muteDestination(<out>)

Unmute Audio Output

- ▶ CALL:/MEDIA/AUDIO/XP:unmuteDestination(<out>)

Lock Output

- ▶ CALL:/MEDIA/AUDIO/XP:lockDestination(<out>)

Unlock Output

- ▶ CALL:/MEDIA/AUDIO/XP:unlockDestination(<out>)

Analog Audio Input Level Settings**Volume**

- ▶ SET:/MEDIA/AUDIO/<in>.Volume=<level>

Balance

- ▶ SET:/MEDIA/AUDIO/<in>.Balance=<level>

Network Configuration**Query the DHCP State**

- ▶ GET:/MANAGEMENT/NETWORK.DhcpEnabled

Change the DHCP State

- ▶ SET:/MANAGEMENT/NETWORK.DhcpEnabled=<logical_value>

Query the IP Address

- ▶ GET:/MANAGEMENT/NETWORK.IpAddress

Change the IP Address (Static)

- ▶ SET:/MANAGEMENT/NETWORK.StaticIpAddress=<IP_address>

Query the Subnet Mask

- ▶ GET:/MANAGEMENT/NETWORK.NetworkMask

Change the Subnet Mask (Static)

- ▶ SET:/MANAGEMENT/NETWORK.StaticNetworkMask=<netmask>

Query the Gateway Address

- ▶ GET:/MANAGEMENT/NETWORK.GatewayAddress

Change the Gateway Address (Static)

- ▶ SET:/MANAGEMENT/NETWORK.StaticGatewayAddress=<gw_address>

RS-232 Port Configuration**Protocol Setting**

- ▶ SET·/MEDIA/UART/<port>.ControlProtocol=<protocol>

BAUD Rate Setting

- ▶ SET·/MEDIA/UART/<port>.Baudrate=<baudrate>

Databits Setting

- ▶ SET·/MEDIA/UART/<port>.DataBits=<databits>

Stopbits Setting

- ▶ SET·/MEDIA/UART/<port>.StopBits=<stopbits>

Parity Setting

- ▶ SET·/MEDIA/UART/ <port>.Parity=<parity>

RS-232 Operation Mode

- ▶ SET·/MEDIA/UART/<port>.Rs232Mode=<mode>

Command Injection Enable

- ▶ SET·/MEDIA/UART/<port>.CommandInjectionEnable=<logical_value>

RS-232 Recognizer**Enable the Recognizer**

- ▶ SET·/MEDIA/UART/<port>.RecognizerEnable=<logical_value>

Set the Delimiter Hex

- ▶ SET·/MEDIA/UART/RECOGNIZER.DelimiterHex=<delimiter>

Set the Timeout

- ▶ SET·/MEDIA/UART/RECOGNIZER.TimeOut=<timeout>

Query the Last Recognized Serial Message in String Format

- ▶ GET·/MEDIA/UART/RECOGNIZER.Rx

Query the Last Recognized Serial Message in Hex Format

- ▶ GET·/MEDIA/UART/RECOGNIZER.RxHex

Query the Last Recognized Serial Message in Hash Format

- ▶ GET·/MEDIA/UART/RECOGNIZER.Hash

Clear the Stored Last Recognized Serial Message

- ▶ CALL·/MEDIA/UART/RECOGNIZER:clear()

Query the Last Recognized Serial Message in String Format

- ▶ GET·/MEDIA/UART/RECOGNIZER.ActiveRx

Query the Last Recognized Serial Message in Hex Format

- ▶ GET·/MEDIA/UART/RECOGNIZER.ActiveRxHex

Query the Last Recognized Serial Message in Hash Format

- ▶ GET·/MEDIA/UART/RECOGNIZER.ActiveHash

Set the Active Timeout

- ▶ SET·/MEDIA/UART/RECOGNIZER.ActivePropertyTimeout=<a_timeout>

Infrared Port Configuration**Enable Command Injection Mode**

- ▶ SET·/MEDIA/IR/<port>.CommandInjectionEnable=true|false

Enable/Disable Output Signal Modulation

- ▶ SET·/MEDIA/IR/<port>.EnableModulation=true|false

Sending Message via the Communication Ports**Sending a TCP Message (ASCII-format) via TCP Port**

- ▶ CALL·/MEDIA/ETHERNET:tcpMessage(<IP_address>:<port_no>=<message>)

Sending a TCP Text (ASCII-format) via TCP Port

- ▶ CALL·/MEDIA/ETHERNET:tcpText(<IP_address>:<port_no>=<text>)

Sending a TCP Binary Message (HEX-format) via TCP Port

- ▶ CALL·/MEDIA/ETHERNET:tcpBinary(<IP_address>:<port_no>=<HEX_message>)

Sending UDP Message (ASCII-format) via TCP Port

- ▶ CALL·/MEDIA/ETHERNET:udpMessage(<IP_address>:<port_no>=<message>)

Sending a TCP Text (ASCII-format) via TCP Port

- ▶ CALL·/MEDIA/ETHERNET:udpText(<IP_address>:<port_no>=<text>)

Sending a UDP Binary Message (HEX-format) via TCP Port

- ▶ CALL·/MEDIA/ETHERNET:udpBinary(<IP_address>:<port_no>=<HEX_message>)

Sending a Message (ASCII-format) via Serial Port

- ▶ CALL·/MEDIA/UART/<port>:sendMessage(<message>)

Sending a Text (ASCII-format) via Serial Port

- ▶ CALL·/MEDIA/UART/<port>:sendText(<message>)

Sending a Binary Message (HEX-format) via Serial Port

- ▶ CALL·/MEDIA/UART/<port>:sendBinaryMessage(<message>)

Sending Pronto Hex Codes in Little-endian Format via IR Port

- ▶ CALL·/MEDIA/IR/<output_port>:sendProntoHex(<hex_code>)

Sending Pronto Hex Codes in Big-endian Format via IR Port

- ▶ CALL·/MEDIA/IR/<output_port>:sendProntoHexBigEndian(<hex_code>)

Sending CEC Commands**Sending an OSD String**

- ▶ SET·/MEDIA/CEC/<port>.OsdString=<text>
- ▶ CALL·/MEDIA/CEC/<port>:send(set_osd)

Sending a CEC Command in Text Format

- ▶ CALL /MEDIA/CEC/<port>:send(<command>)

Sending a CEC Command in Hexadecimal Format

- ▶ CALL /MEDIA/CEC/<port>:sendHex(<hex_code>)

GPIO Port Configuration**Set the Direction of a GPIO Pin**

- ▶ SET·/MEDIA/GPIO/<port>.Direction=<direction>

Set the Output Level of a GPIO Pin

- ▶ SET·/MEDIA/GPIO/<port>.Output=<value>

Toggle the Level of a GPIO Pin

- ▶ CALL·/MEDIA/GPIO/<port>:toggle()

EDID Management**Query the Emulated EDIDs**

- ▶ GET·/EDID.EdidStatus

Query the Validity of a Dynamic EDID

- ▶ GET·/EDID/D/<dynamic>.Validity

Query the Preferred Resolution of an User EDID

- ▶ GET·/EDID/U/<user>.PreferredResolution

Emulating an EDID to an Input Port

- ▶ CALL·/EDID:switch(<dynamic|user|factory>;<emulated>)

Emulating an EDID to All Input Ports

- ▶ CALL·/EDID:switchAll(<dynamic|user|factory>)

Copy an EDID to User Memory

- ▶ CALL·/EDID:copy(<dynamic|emulated|factory|user>;<user>)

Deleting an EDID from User Memory

- ▶ CALL·/EDID:delete(<user>)

Resetting the Emulated EDIDs

- ▶ CALL·/EDID:reset()

8

Firmware Upgrade

The endpoint devices can be upgraded by using **Lightware Device Updater v2 (LDU2) software via Ethernet**. The firmware pack with the necessary components (*.lfp2 file) for your specific product, and the LDU2 application can be downloaded from the Support page of our website www.lightware.com.

- ▶ [INSTALLATION OF LDU2](#)
- ▶ [DETAILED INSTRUCTIONS](#)
- ▶ [KEEPING THE CONFIGURATION SETTINGS](#)
- ▶ [REMOTE FIRMWARE UPGRADE OF CONNECTED LIGHTWARE DEVICES](#)
- ▶ [USE CASES](#)
- ▶ [HOW TO SPEED UP THE TROUBLESHOOTING PROCESS](#)

ATTENTION! While the firmware is being upgraded, the normal operation mode is suspended as the endpoint is switched to bootload mode. Signal processing is not performed. Do not interrupt the firmware upgrade. If any problem occurs, reboot the receiver and restart the process.

ATTENTION! The firmware upgrade process has an effect on the configuration and the settings of the device. For more details, please see the [Keeping the Configuration Settings](#) section before the upgrade.

8.1. About the Firmware Package (LFP2 File)

The firmware files are packed in an LFP2 package. You need only this file to do the upgrade on your device.

- The package contains all the necessary components, binary, and other files;
- The package also contains each firmware with version number and a list showing the compatible devices.

8.2. Short Instructions

Step 1. Get the firmware pack and the Lightware Device Updater v2 (LDU2) application.

Step 2. Install the LDU2 application.

Step 3. Establish connection between the computer and the device(s) via Ethernet.

Step 4. Start LDU2 and follow the instructions shown on the screen.

8.3. Installation of LDU2

Minimum System Requirement

RAM: 1 GB

Installation Modes

LDU2 has two installation modes: **Normal** and **Snapshot**.

Normal install	Snapshot install
Available for Windows and macOS	Available for Windows
The installer can update only this instance	Cannot be updated
Only one updateable instance can exist for all users	More than one different version can be installed for each user

Comparison of install types

ATTENTION! Using the Normal install as the default value is highly recommended.

Applied firmware package: v1.4.0 | LDC software: v1.34.2b1

Installation for Windows OS

Run the installer. If the User Account Control drops a pop-up message click **Yes**. During the installation you will be prompted to select the type of the installation.

Installation for macOS

Mount the DMG file with double clicking on it and drag the LDU2 icon over the Applications icon to copy the program into the Applications folder. If you want to copy the LDU2 into another location just drag the icon over the desired folder.

INFO: After the installation the Windows and the macOS application has the same look and functionality.

8.4. Detailed Instructions

8.4.1. Establish Connection

Make sure that the computer and the device are connected over **Ethernet** and the connection is established between them.

8.4.2. Start the LDU2 Application and Follow the Steps

The Steps of the Upgrade in Quick Summary:

Step 1. Select the firmware package file.

Step 2. Select the unit(s) for upgrading.

Step 3. Check the upgrade parameters.

Step 4. Start the update and wait until it is finished.

Step 5. Wait until the unit reboots with the new firmware.

Discovering the Devices

After launching LDU2 the device discovery process starts finding the Lightware devices on the network.

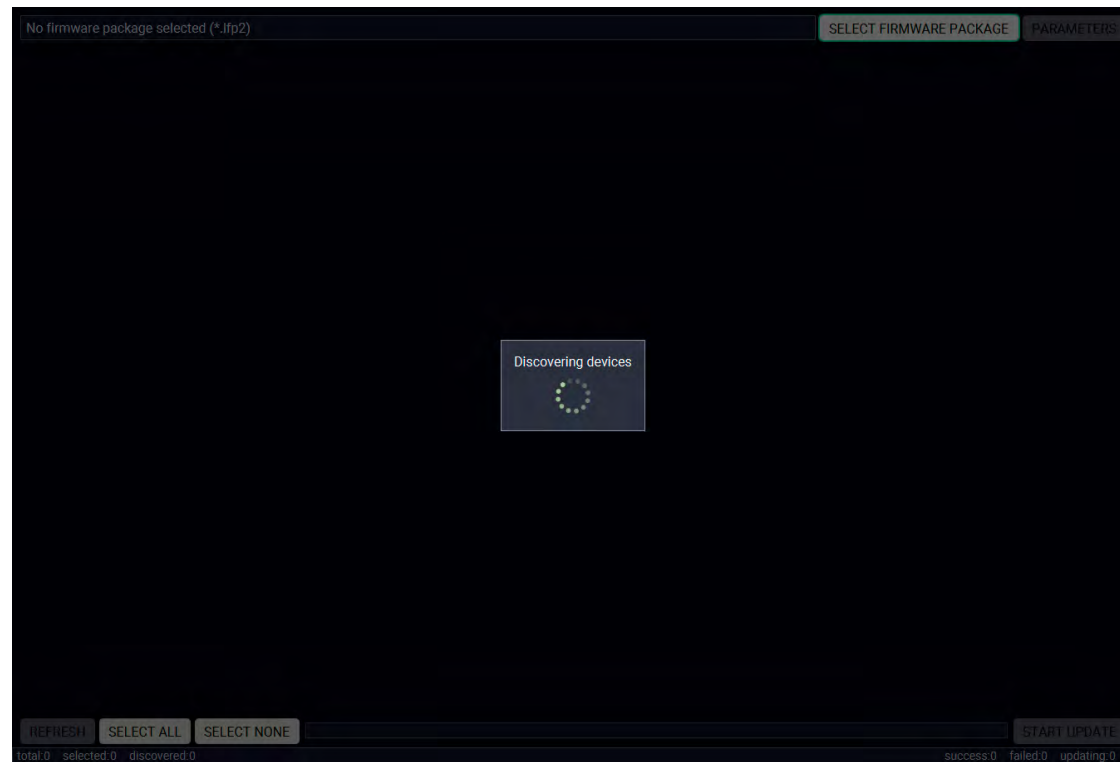

Device discovery is in progress in LDU2

Device List

When the discovery has completed, the devices available on the network are listed in the application.



Legend of the Icons

Icon	Name	Description
	Identify the device	Clicking on the icon causes all front panel LEDs blink in green for 10 seconds. The feature helps to identify the device itself in the rack shelf.
	IP address editor	To modify IP address settings quickly it is not necessary to enter the device's settings/network menu, you can set them by clicking the pencil icon beside the IP address.
	Further information available	Device is unreachable. Change the IP address using the front panel LCD menu or the IP address editor of the LDU2.
	Service mode	The device is in bootloader (service) mode. The firmware upgrade procedure can be continued in this mode.

Upgrade Steps

Step 1. Select the firmware package.

Click on the **Select Firmware Package** button and navigate to the location where the LFP2 file of the device is saved. When you click on the name of package, the preview of the release notes are displayed on the right side.

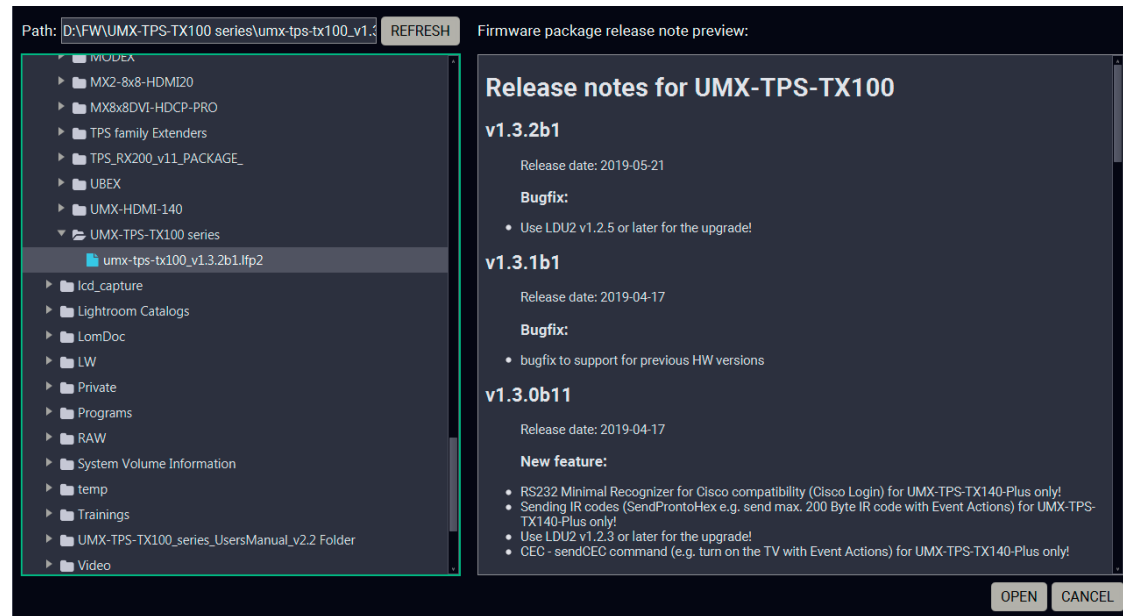

Firmware file browser and the release notes window

After the package file is loaded, the list is filtered to show compatible devices only. The current firmware version of the device is highlighted in orange if it is different from the version of the package loaded.

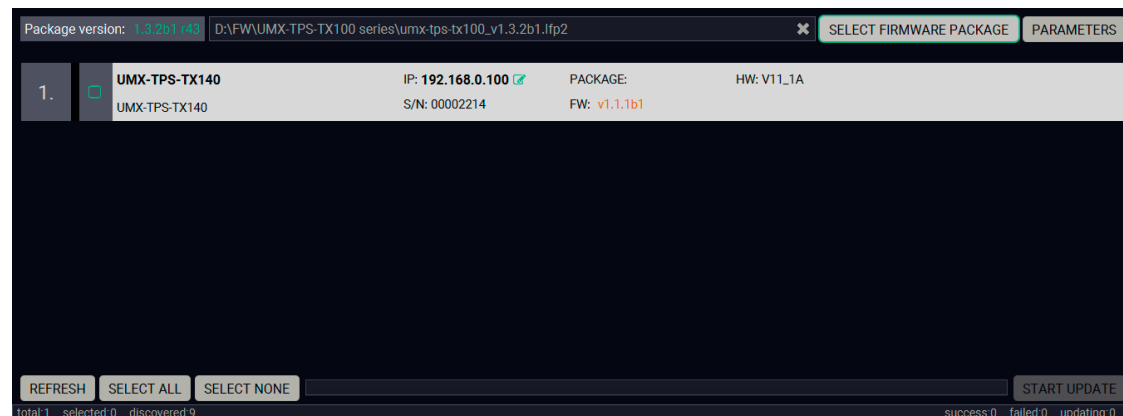

Filtered device list based on the selected firmware package

Step 2. Select the unit for upgrading.

Pick the device for upgrading. The selected line will be highlighted in green.

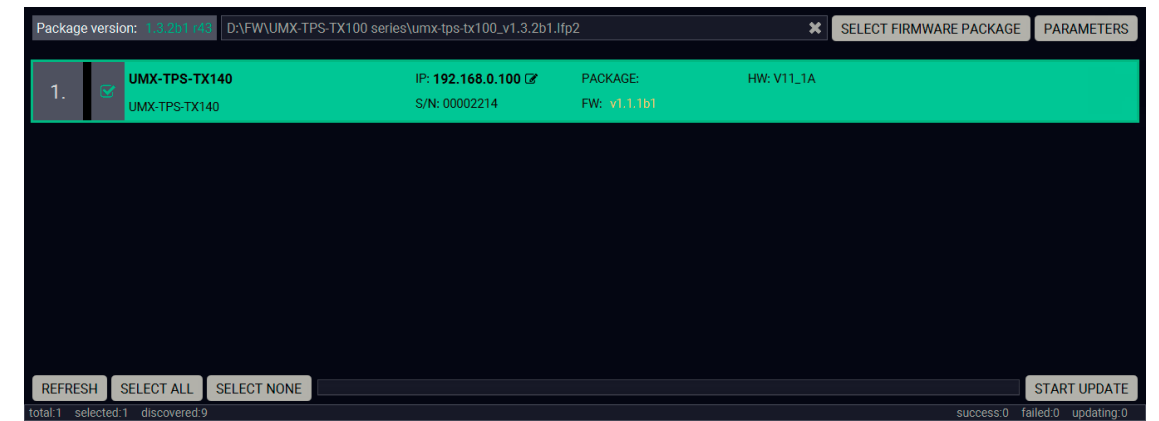

The unit is selected for upgrading

TIPS AND TRICKS: If you are not sure which device is connected to your controller device directly, use the **Identify me** feature clicking on the button. It makes the four front panel LEDs blink in green for 10 seconds. The feature helps to identify the device itself in the rack shelf or on the desk.

Step 3. Check the upgrade parameters.

ATTENTION! The default settings in the Parameters window should be fine for most cases. Please do not modify them if it is not necessary.

Click on the **Parameters** button to configure the firmware upgrade.

Backup and Restore settings

Restore device configuration: restore device configuration from the backup file created at the beginning of the update process.

Factory default: if it is selected, all user settings and parameters will be cleared and the factory default settings will be applied to the device when the upgrade is done. See the whole list of factory default settings of the endpoint device in the [Factory Default Settings](#) section.

Once the parameters are set, click on the **Apply** button to save the settings.

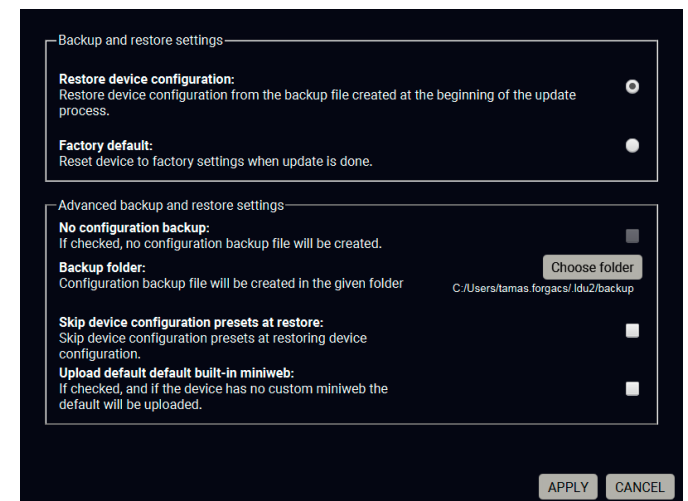

Step 4. Start the update and wait until it is finished.

Click on the **Start Update** button to start the procedure. The status is shown in percent in the right side of the device line and the status of the all procedures in the lower light green progress bar.

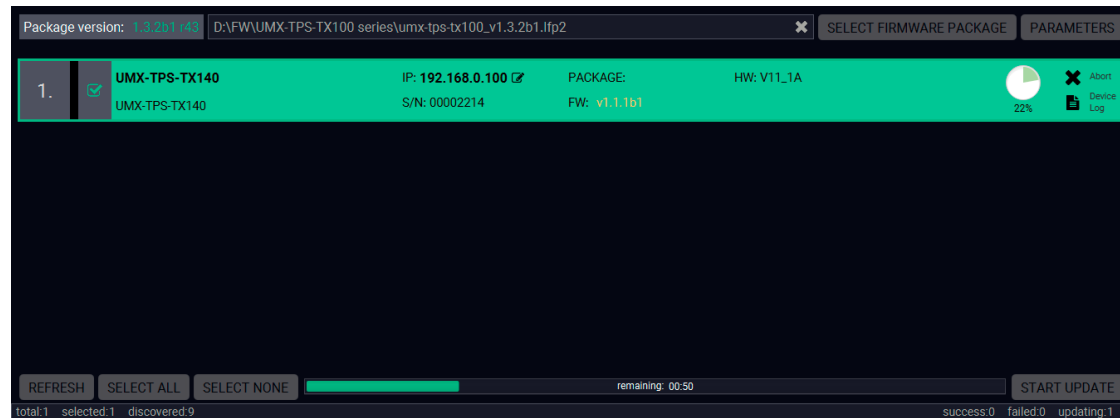

Firmware upgrade is in progress

INFO: The device might reboot several times during the firmware upgrade procedure.

Step 5. Wait until the unit reboots with the new firmware.

Once the firmware upgrade procedure is completed, the unit reboots with the new firmware.

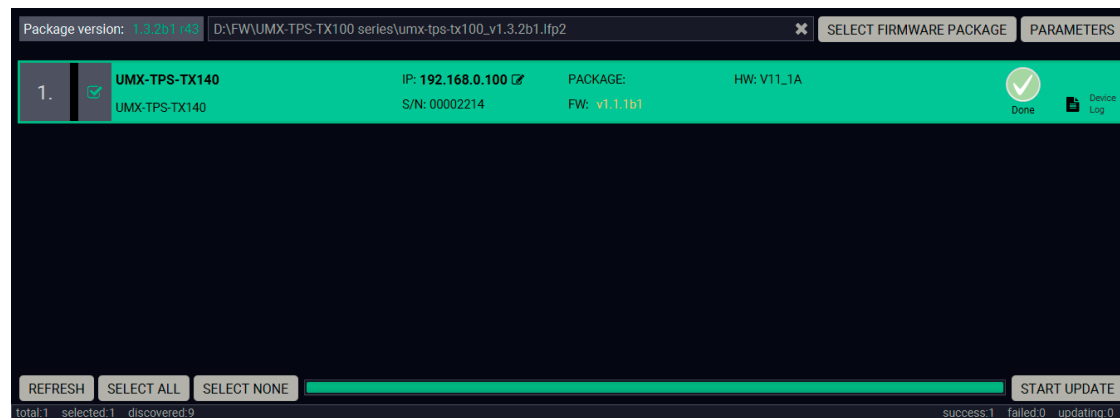

Firmware upgrade procedure is done

8.5. Keeping the Configuration Settings

By default, device configuration settings are restored when firmware upgrade is finished. If factory reset has been chosen in the parameters window, all device settings will be erased. In the case of factory reset you can save the settings of the device in the Lightware Device Controller software and restore it later. See the details in the [Configuration Cloning \(Backup Tab\)](#) section.

The following flow chart demonstrates how this function works in the background.

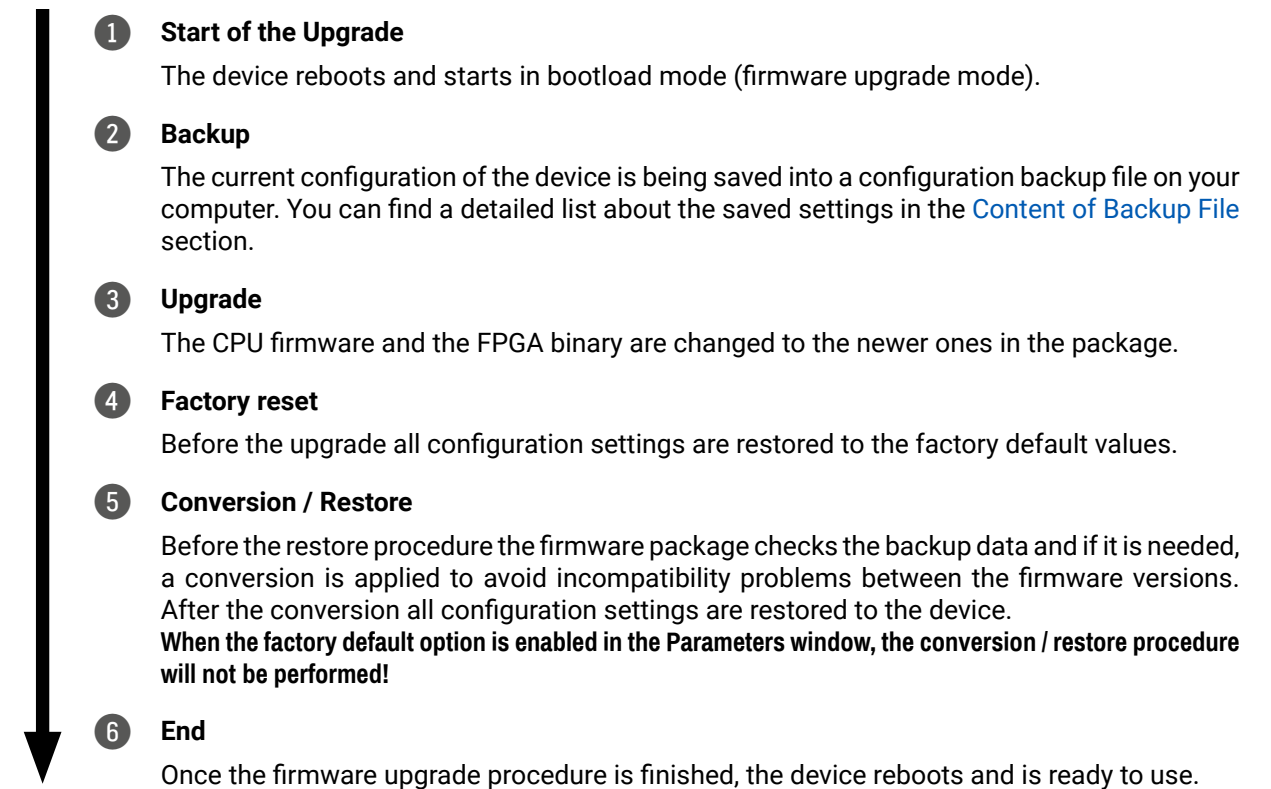

The details about the procedure: when firmware upgrade starts, the first step is making a backup of the settings of the device. The firmware package checks the backup data and if it is needed, a conversion is applied to avoid incompatibility problems between the firmware versions. If you do not want to keep configuration settings, you can set the **Factory default** option enabled.

8.6. Remote Firmware Upgrade of Connected Lightware Devices

Firmware of Lightware devices can be upgraded via another connected Lightware device without removing the device from the system. It means user does not have to connect directly to the upgradable device, it can be reached and flashed through other devices. It's a more comfortable way to keep up-to-date your Lightware devices.



There are two types of remote upgrading:

Extended Upgrade

- Intelligent devices can be upgraded via another intelligent or basic device via TPS or OPTS/OPTM link.
- For example, UMX-TPS-TX100 series extenders can be upgraded via MMX6x2-HT series matrix or a HDMI-TPS-RX95 extender.

Hosted Upgrade





- Basic devices can be upgraded only via an intelligent device via TPS link.
- For example, TPS 95 series extenders can be upgraded via MMX6x2-HT series matrix or UMX-TPS-TX100 series extenders.
- In case of hosted upgrade, the procedure is almost the same as described in Firmware upgrade – [Detailed Instructions](#). The only difference is that the host device's name, and IP address appears beside the name of the device to be upgraded.

ATTENTION! During hosted upgrade the host device turned to bootload mode when the extender is upgraded. During the upgrade normal operation mode is suspended. When the upgrade is successfully finished, the normal operation mode is restored.

9

Troubleshooting

Usually, if the system seems not to transport the signal as expected, the best strategy for troubleshooting is to check signal integrity through the whole signal chain starting from source side and moving forward to the receiver end.























-  Link to connections/cabling section.
-  Link to front panel operation section.
-  Link to LDC software section.
-  Link to LW2 protocol commands section.
-  Link to LW3 protocol commands section.























The following sections are available in the chapter:









- ▶ [EDID MANAGEMENT](#)
- ▶ [HDCP MANAGEMENT](#)

9.1. Use Cases

At first, check front panel LEDs and take the necessary steps according to their states. For more information about status, LEDs refer to [Front Panel LEDs](#) and [Rear Panel LEDs](#) sections.

Symptom	Root cause	Action	Refer to
Video signal			
No picture on the video output	Device or devices are not powered properly	Check the extenders and the other devices if they are properly powered; try to unplug and reconnect them.	 3.7.1  3.7.2
	Cable connection problem	Cables must fit very well, check all the connectors (video and TPS cables).	 3.7
	TPS mode problem	Check the actual TPS mode and the selected modes of the extenders.	 5.5.4  7.4.25
	The input port is muted	Check the mute state of input port.	 5.5  6.3.6  7.4.1
	The output port is muted	Check the mute state of output port.	 5.5.4  6.3.6  7.4.2
	Display is not able to receive the video format	Check the emulated EDID; select another (e.g. emulate the display's EDID on the input port).	 5.7  7.14
	HDCP is disabled	Enable HDCP on the input and output ports.	 5.5.2  5.5.4  7.4.18  7.4.22
Not the desired picture displayed on the video output	Video input is set to test pattern (no sync screen) statically	Check test pattern settings in the properties of the input ports.	 5.6.2  7.4.19
	Video source is set to Testpattern input (I6)	Check the crosspoint settings	 5.4  6.3.6  7.4.3
	Video output is set to test pattern (no sync screen) as there is no picture on video source	Check video settings of the source.	

Symptom	Root cause	Action	Refer to
Audio signal			
No audio is present on output	Source audio volume is low or muted	Check the audio settings of the source.	
	Audio input port is muted	Check the audio input port properties	 5.5  6.3.6  7.5.1
	Audio output port is muted	Check the output port properties.	 5.5  6.3.6  7.5.2
HDMI output signal contains no audio	HDMI mode was set to DVI	Check the properties of the output port and set the signal type to HDMI or Auto.	 5.5.4  7.4.23
	DVI EDID is emulated	Check the EDID and select and HDMI EDID to emulate.	 5.7  7.14
RS-232 signal			
Connected serial device does not respond	Cable connection problem	Check the connectors to fit well; check the wiring of the plugs.	 3.7.10
	RS-232 settings are different	Check the port settings of the transmitter and the connected serial device(s).	 5.8.1  7.8
	RS-232 mode is not right	Check the RS-232 mode settings (control, command injection, or disconnected)	 5.8.1  7.8.6
Network			
No LAN connection can be established	Incorrect IP address is set (fix IP)	Use dynamic IP address by enabling DHCP option.	 4.4.1  5.10.2  7.7.2
		Restore the factory default settings (with fix IP).	 4.4.2  5.10.5  6.2.11  7.3.6
	IP address conflict	Check the IP address of the other devices, too.	

Symptom	Root cause	Action	Refer to		
GPIO					
Connected device does not respond	Cable connection problem	Check the connectors to fit well; check the wiring of the plugs.	 3.7.13		
Output level cannot be changed	The direction of the selected pin is set to input	Check and modify the direction setting of the desired pin	 5.8.3  6.5.1  7.13		
		USB KVM			
		USB device does not operate	Cables are not connected on both sides	Check the USB cable between TX and the computer.	
Not supported USB device is connected	Keyboard, mouse (USB HID devices) are supported mostly, check your device type.				
Miscellaneous					
Front panel buttons are out of operation	Buttons are locked	Unlock the buttons	 4.4.4  5.10.1		
		Error messages received continuously	Different protocol is set	Check the port protocol settings (LW2 / LW3) and use the proper protocol commands.  5.8.1  7.8.1	

9.2. How to Speed Up the Troubleshooting Process

Lightware's technical support team is always working hard to provide the fastest support possible. Our team's response time is one of the best in the industry and in the toughest of cases we can directly consult with the hardware or software engineer who designed the product to get the information from the most reliable source.

However, the troubleshooting process can be even faster... with your help.

There are certain pieces of information that push us in the right direction to finding the root cause of the problem. If we receive most of this information in the first e-mail or it is gathered at the time when you call us, then there is a pretty high chance that we will be able to respond with the final solution right away.

This information is the following:

- Schematic (a pdf version is preferred, but a hand drawing is sufficient).
- Serial number(s) of the device(s) (it is either printed somewhere on the box or you can query it in the Device Controller software or on the built-in website).
- Firmware versions of the devices (please note that there may be multiple CPUs or controllers in the device and we need to know all of their firmware versions, a screenshot is the best option).
- Cable lengths and types.
- Patch panels, gender changers or anything else in the signal path that can affect the transmission.
- Signal type (resolution, refresh rate, color space, deep color).
- Emulated EDID(s) (please save them as file and send them to us).
- Actions to take in order to re-create the problem (if we cannot reproduce the problem, it is hard for us to find the cause).
- Photo or video about the problem (for example: "image noise" can mean many different things, it's better if we see it too).
- Error logs from the Device Controller software.
- In the case of Event Manager issue the event file and/or backup file from the Device Controller software.

The more of the above information you can give us the better. Please send these information to the Lightware Support Team (support@lightware.com) to speed up the troubleshooting process.

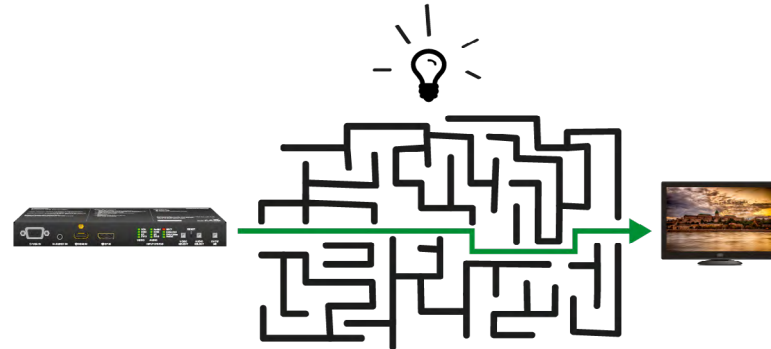

10

Technologies

The following sections contain descriptions and useful technical information how the devices work in the background. The content is based on experiences and cases we met in the practice. These sections help to understand features and technical standards like the followings:

- ▶ [PIXEL ACCURATE RECLOCKING SPECIFICATION](#)
- ▶ [FACTORY DEFAULT SETTINGS](#)

10.1. EDID Management

10.1.1. Understanding the EDID

The Extended Display Identification Data (EDID) is the passport of display devices (monitors, TV sets, projectors). It contains information about the capabilities of the display, such as supported resolutions, refresh rates (these are called Detailed Timings), the type and manufacturer of the display device, etc.

After connecting a source to a display (DVI, HDMI, DP), the source reads out the EDID to determine the resolution and refresh rate of the image to be transmitted.

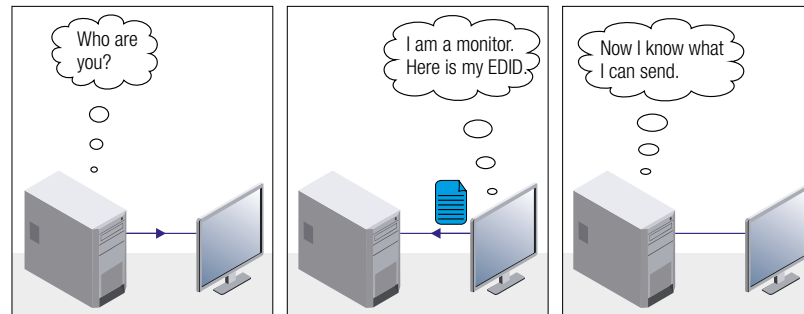

EDID Communication

Most DVI computer displays have 128-byte long EDID structure. However, Digital Televisions and HDMI capable displays may have another 128 bytes, which is called E-EDID and defined by CEA (Consumer Electronics Association). This extension contains information about additional Detailed Timings, audio capabilities, speaker allocation and HDMI capabilities. It is important to know that all HDMI capable devices must have CEA extension, but not all devices with CEA extension are HDMI capable.

Common Problems Related to EDID

Problem: “My system consists of the following: a computer, a Lightware device, a WUXGA (1920x1200) LCD monitor, and an SXGA (1280x1024) projector. I would like to see the same image on the monitor and the projector. What EDID should I choose on the Lightware device?”

Solution: If you want to see the image on both displays, you need to select the resolution of the smaller display (in this case SXGA), otherwise the smaller display may not show the higher resolution image.

Problem: “I have changed to a different EDID on an input port of the Lightware device to have a different resolution but nothing happens.”

Solution: Some graphics cards and video sources read out the EDID only after power-up and later they do not sense that EDID has been changed. You need to restart your source to make it read out the EDID again.

10.1.2. Advanced EDID Management

Each DVI sink (e.g. monitors, projectors, plasma displays, etc...) must support the EDID data structure. Source BIOS and operating systems are likely to query the sink using DDC2B protocol to determine what pixel formats and interface are supported. DVI standard uses EDID data structure to identify the monitor type and capabilities. Most DVI sources (VGA cards, set top boxes, etc.) will output DVI signal after accepting the connected sink's EDID information. In the case of EDID readout failure or missing EDID, the source will not output DVI video signal.

Lightware devices provide the Advanced EDID Management function that helps system integration. The built-in EDID Router can store and emulate factory pre-programmed- and User programmable EDIDs. The EDID of the attached monitors or projectors for each output are stored in a non-volatile memory. This way the EDID of a monitor is available when the monitor is unplugged or switched off.

Any EDID can be emulated on any input. An emulated EDID can be copied from the EDID router's memory (static EDID emulation), or from the last attached monitor's memory (dynamic EDID emulation). For example, the Lightware device can be set up to emulate a sink device, which is connected to one of the outputs. In this case, the EDID automatically changes, if the monitor is replaced with another display device (as long as it has a valid EDID).

EDID is independently programmable for all inputs without affecting each other. All inputs have their own EDID circuit.

INFO: The user is not required to disconnect the video cable to change an EDID as opposed to other manufacturer's products. EDID can be changed even if a source is connected to the input and powered ON.

INFO: When EDID has been changed, the router toggles the HOTPLUG signal for 2 seconds. Some sources do not sense this signal. In such cases, the source device must be restarted or powered OFF and ON again.

10.2. HDCP Management

Lightware Visual Engineering is a legal HDCP adopter. Several functions have been developed which helps to solve HDCP related problems. Complex AV systems often have both HDCP and non-HDCP components. The transmitter allows transmitting HDCP encrypted and unencrypted signals. The devices will be still HDCP compliant as they will never output an encrypted signal to a non-HDCP compliant display device. If an encrypted signal is switched to a non-compliant output, a red screen alert or muted screen will appear.

10.2.1. Protected and Unprotected Content

Many video sources send HDCP protected signal if they detect that the sink is HDCP capable – even if the content is not copyrighted. This can cause trouble if an HDCP capable device is connected between the source and the display. In this case, the content cannot be viewed on non-HDCP capable displays and interfaces like event controllers. Rental and staging technicians often complain about certain laptops, which are always sending HDCP encrypted signals if the receiver device (display, matrix router, etc.) reports HDCP compliancy. However, HDCP encryption is not required all the time e.g. computer desktop image, certain laptops still do that.

To avoid unnecessary HDCP encryption, Lightware introduced the HDCP enabling/disabling function: the HDCP capability can be disabled in the Lightware device. If HDCP is disabled, the connected source will detect that the sink is not HDCP capable, and turn off authentication.

10.2.2. Disable Unnecessary Encryption

HDCP Compliant Sink

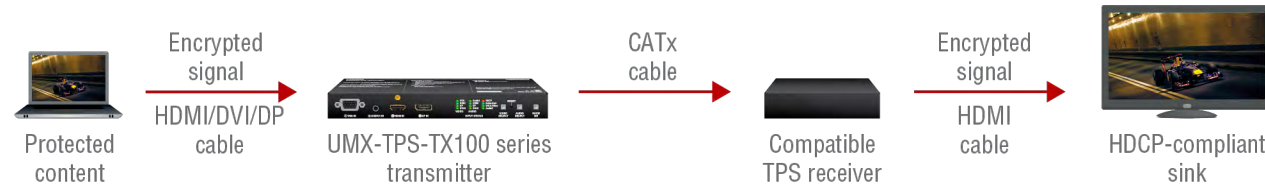

All the devices are HDCP-compliant, no manual setting is required, both protected and unprotected contents are transmitted and displayed on the sink.

Not HDCP-compliant Sink 1.

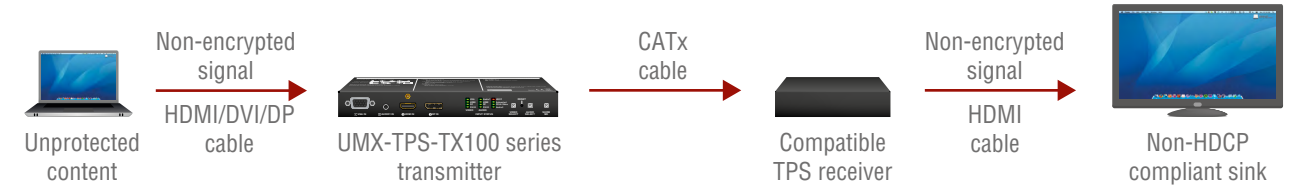

Not-HDCP compliant sink is connected to the receiver. Some sources (e.g. computers) always send HDCP encrypted signals if the receiver device reports HDCP compliancy, however, HDCP encryption is not required all the time (e.g. computer desktop image). If HDCP is enabled in the transmitter, the image will not be displayed on the sink.

Setting the HDCP parameter to Auto on the output port and disable HDCP on the input port, the transmitted signal will not be encrypted if the content is not protected. Thus, non-HDCP compliant sinks will display non-encrypted signal.

Not HDCP-compliant Sink 2.

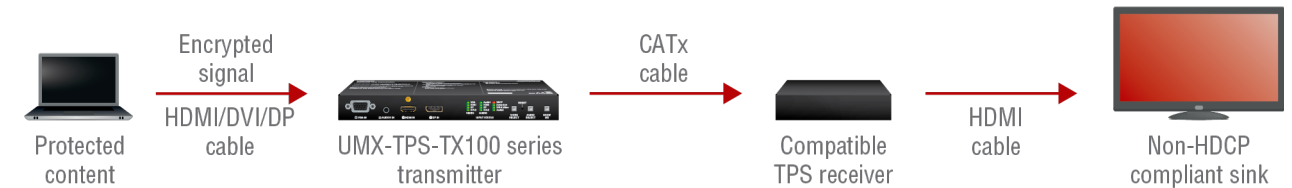

The layout is the same as in the previous case: non-HDCP compliant display device is connected to the receiver but the source would send protected content with encryption. If HDCP is enabled on the input port of the transmitter, the source will send encrypted signal. The sink is not HDCP compliant, thus, it will not display the video signal (but blank/red/muted/etc. screen). If HDCP is disabled on the input port of the transmitter, the source will not send the signal. The solution is to replace the display device to an HDCP-capable one.

10.3. Pixel Accurate Reclocking

Signal reclocking is an essential important procedure in digital signal transmission. After passing the reclocking circuit, the signal becomes stable, jitter-free, and can be transmitted over more equipment like processors, or event controllers. Without reclocking, sparkles, noise, and jaggies appear on the image.

Lightware's sophisticated Pixel Accurate Reclocking technology fixes more problems than general TMDS reclocking. It removes not only intra-pair skew but inter-pair skew as well. The Pixel Accurate Reclocking circuit eliminates the following errors:

Intra-pair skew

Skew between the + and - wires within a differential wire pair (e.g. Data2- and Data2+). It's caused by different wire lengths or slightly different wire construction (impedance mismatch) in DVI cable. It results in jitter.

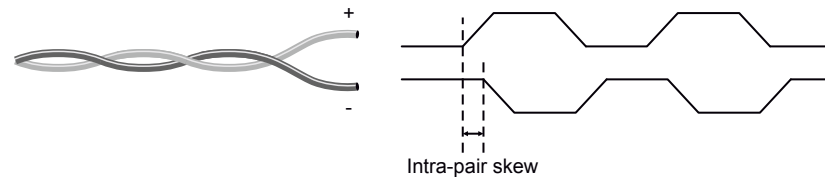

Inter-pair skew

Skew between two differential wire pairs in a cable. It is caused by different wire pair lengths or different number of twists in the DVI cable. Too much inter-pair skew results color shift in the picture or sync loss.

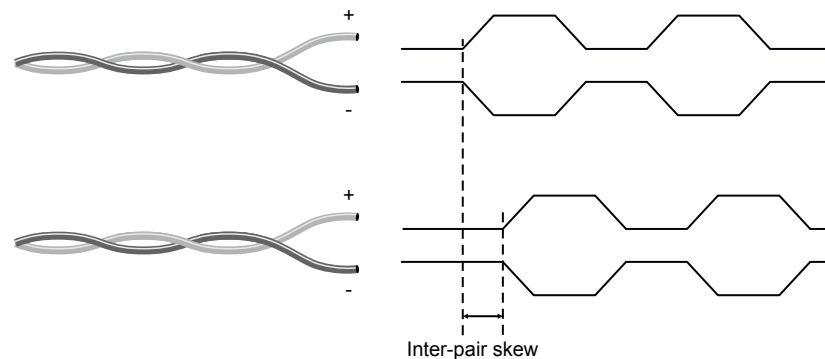

Jitter

Signal instability in the time domain. The time difference between two signal transitions should be a fixed value, but noise and other effects cause variations.

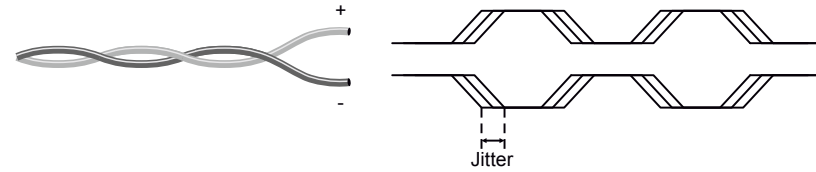

Noise

Electromagnetic interference between other electronic devices such as mobile phones, motors, etc. and the DVI cable are coupled onto the signal. Too much noise results in increased jitter.

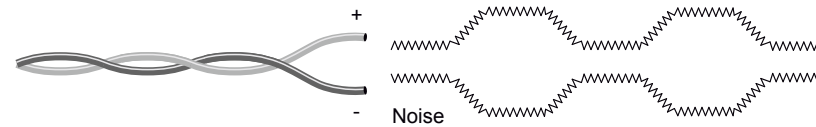

11

Appendix

Tables, drawings, guides, and technical details as follows:

- ▶ [CONTENT OF BACKUP FILE](#)
- ▶ [CABLE WIRING GUIDE](#)
- ▶ [MECHANICAL DRAWINGS](#)
- ▶ [PORT NUMBERING](#)
- ▶ [MAXIMUM EXTENSION DISTANCES](#)
- ▶ [FACTORY EDID LIST](#)
- ▶ [RELEASE NOTES OF THE FIRMWARE PACKAGES](#)
- ▶ [FURTHER INFORMATION](#)

11.1. Specification

General

Compliance	CE
EMC compliance (emission).....	IEC/EN 55032:2015
EMC compliance (immunity).....	IEC/EN 55035:2017
Safety compliance	IEC/EN 62368-1:2014
Warranty	3 years
Cooling - UMX-TPS-TX100 series	Passive
Cooling - WP/FP-UMX-TPS-TX100 series	1x built-in fan
Operating temperature	0 to +50°C (+32 to +122°F)
Operating humidity	10% to 90%, non-condensing

Power (UMX-TPS-TX100 series)

Power supply.....	External power adaptor or PoE remote powering
Power adaptor.....	In 100-240 V AC 50/60 Hz, Out 12V DC, 1 A
Power connector.....	Locking DC connector (2.1 mm pin)
Power over TPS.....	DC 48V, 1A (IEEE 802.3af)
Power consumption.....	9 W

Power (WP-UMX-TPS-TX100 series)

Power supply.....	External power adaptor or PoE remote powering
Power adaptor.....	In 100-240 V AC 50/60 Hz, Out 48V DC, 1 A
Power connector.....	Phoenix® Combicon (2-pole)
Power over TPS.....	DC 48V, 1A (IEEE 802.3af)
Power consumption.....	9 W

Power (FP-UMX-TPS-TX100 series)

Power supply.....	External power adaptor or PoE remote powering
Power adaptor.....	In 100-240 V AC 50/60 Hz, Out 48V DC, 1 A
Power connector.....	Phoenix® Combicon (2-pole)
Power over TPS.....	DC 48V, 1A (IEEE 802.3af)
Power consumption.....	9 W

Enclosure (UMX-TPS-TX100 series)

Rack mountable	Yes
Material.....	1 mm steel
Dimensions in mm.....	221W x 100.4D x 26H
Dimensions in inch	8.7 W x 3.95 D x 1.02 H
Weight - UMX-TPS-TX120.....	629 g
Weight - UMX-TPS-TX130.....	642 g
Weight - UMX-TPS-TX140.....	647 g
Weight - UMX-TPS-TX140-Plus	647 g

Enclosure (WP-UMX-TPS-TX100 series)

Rack mountable	No
Material.....	1 mm steel
Dimensions in mm.....	115.9W x 67.5D x 114.3H
Dimensions in inch	4.56 W x 2.65 D x 4.5 H
Weight.....	457 g

Enclosure (FP-UMX-TPS-TX100 series)

Rack mountable	No
Material.....	1 mm steel
Dimensions in mm.....	116 W x 54.4 D x 77 H
Dimensions in inch	4.56 W x 2.14 D x 3.03 H
Weight.....	330 g
Weight with MKM bracket	606 g

Video Ports

VGA Input

Connector type.....	DE-15F (15-pole D-sub Female)
Supported video signal.....	Analog RGB and YPbPr video
Color depth.....	Up to 24 bits, 8 bit/color
Max. data rate	Up to 170 MHz video and graphics digitizer
Max. resolution	Up to 1600x1200@60 Hz

HDMI Input

HDMI port connector type	19-pole HDMI Type A receptacle
Standard	DVI 1.0, HDMI 1.4
Color depth	Deep color support up to 36 bits, 12 bit/color
Color space	RGB, YCbCr 4:4:4, YcbCr 4:2:2
Max. video resolutions	1920x1080@120 Hz, 24 bit 1600x1200@60 Hz, 36 bit 3840x2160@30 Hz, 24 bit
Audio formats	8 channel PCM, Dolby TrueHD DTS-HD Master Audio 7.1
Reclocking	Pixel Accurate Reclocking
3D support	Yes
HDCP compliant	Yes, 1.1

DisplayPort Input

DisplayPort connector type	20-pole, DP 1.1a receptacle
Color depth	Deep color support up to 36 bits, 12 bit/color
Color space	RGB, YcbCr 4:4:4, YCbCr 4:2:2
Max. video resolutions	1920x1080@120 Hz 2560x1600@60 Hz 4096x2400@30 Hz
3D support	Yes
HDCP compliant	Yes, 1.3

DVI-I Input with DVI-D support

Connector type	29-pole, DVI-I
Standard	DVI 1.0, HDMI 1.4
Color depth	Deep color support up to 36 bits, 12 bit/color
Color space	RGB, YCbCr 4:4:4, YcbCr 4:2:2
Max. video resolutions	1920x1080@120 Hz, 24 bit 1600x1200@60 Hz, 36 bit 3840x2160@30 Hz, 24 bit
Audio formats	8 channel PCM, Dolby TrueHD DTS-HD Master Audio 7.1

Reclocking	Pixel Accurate Reclocking
3D support	Yes
HDCP compliant	Yes, 1.1

DVI-I Input with DVI-A support

Connector type	29-pole, DVI-I
Supported video signal	Analog RGB and YPbPr video
Color depth	Up to 24 bits, 8 bit/color
Max. data rate	Up to 170 MHz video and graphics digitizer
Max. resolution	Up to 1600x1200@60 Hz

TPS Output Port

TPS port connector type	RJ45 connector
Compliance	HDBaseT™
Transferred signals	Video, Audio, RS-232, Infrared, Ethernet
Max. video resolutions	1920x1080@120 Hz, 24 bit 1600x1200@60 Hz, 36 bit 3840x2160@30 Hz, 24 bit

Audio Ports**Embedded Audio Signal**

Supported on	DisplayPort, DVI-D, HDMI ports
Supported audio formats	Up to 8 channel PCM, Dolby TrueHD DTS HD Master Audio 7.1 formats

Analog Audio Input (Jack)

Connector type	3.5mm TRS (approx. 1/8" jack)
Sampling frequency	48 kHz
Volume	-95.62 – 0 dB
Maximum input level	+0 dBu, 0.77 Vrms, 2.19 Vpp

Analog Audio Input (Phoenix)

Connector type	5-pole Phoenix connector
Signal transmission	Balanced and unbalanced audio
Sampling frequency	48 kHz

Volume	-95.62 – 0 dB
Maximum input level	+4 dBu, 1.23 Vrms, 3.47 Vpp

Control Ports**RS-232**

Connector type	3-pole Phoenix connector
Available Baud rates	between 4800 and 115200 baud
Available Data bits	8 or 9
Available Parity	None / Odd / Even
Available Stop bits	1 / 1.5 / 2

Infrared

Number of IR ports	2 (1x RX, 1x TX)
Connector type	1 x 3.5mm TRS and 1 x 3.5mm TS (approx. 1/8" jack)

Ethernet

Connector type	Locking RJ45
Ethernet data rate	10/100Base-T, full duplex with autodetect
Power over Ethernet (PoE)	Not supported

GPIO

Connector type	8-pole Phoenix connector
Number of configurable pins	7
Port direction	Input or output
Input voltage: Low level	0 - 0,8 V
Input voltage: High level	2 - 5 V
Output voltage: Low level	0 - 0,5 V
Output voltage: High level	4.5 - 5 V
Max. current: Low level	30 mA
Max. current: High level	18 mA
Total available current	180 mA

USB Specifications

USB standards	Only HID devices
USB HUB	Not supported
Device number	2x USB HID devices

EDID Management

EDID emulation Yes, both on the analog and on the digital inputs
 EDID memory 120 factory presets, 15 user-programmable

11.2. Factory Default Settings

Parameter	Setting/Value
Crosspoint settings	
Video	I1 (VGA in)
Audio	I1 (Analog audio in 1)
Video port settings	
HDCP	Enabled
Autoselect	Disabled
Emulated EDID on analog video inputs	Factory #89: Universal Analog EDID
Emulated EDID on digital video inputs	Dynamic #1: Copy EDID from connected sink device.
Test pattern mode	Auto
Test pattern resolution	640x480p
Test pattern color (RGB code)	#7F7F7F (grey)
Test pattern resolution on Testpattern input (I6)	640x480p
Test pattern color (RGB code) on Testpattern input (I6)	#108020 (green)
Output signal type	Auto
Output HDCP mode	Auto
Power 5V mode	Always on
Color space	Auto
TPS mode	Auto
Analog audio port settings (I1 and I5)	
Volume	0.00 dB (100%)
Balance	50 (center)
Network settings	
IP address	192.168.0.100
Subnet mask	255.255.255.0
Static gateway	192.168.0.1

Parameter	Setting/Value
DHCP	Disabled
LW2 port number	10001
LW3 port number	6107
HTTP port number	80
RS-232 settings	
Control protocol	LW2
Baud rate	57600
Databits	8
Parity	None
Stopbits	1
Operation mode	Pass-through
Command injection port nr. - Local	8001
Command injection port nr. - TPS	8002
IR port settings	
Command injection status	Enabled
Comm. inj. input port nr. - Local	9001
Comm. inj. output port nr. - Local	9002
Comm. inj. input port nr. - TPS	9003
Comm. inj. output port nr. - TPS	9004
GPIO port settings	
Output level	High
Direction	Input

11.3. Content of Backup File

The backup file contains numerous settings and parameters saved from the device. When the file is uploaded to a device, the followings will be overwritten:

Analog video input ports (VGA, DVI-A)
Horizontal position, Vertical position, Active horizontal size, Active vertical size, Total horizontal size, Pixel phase
Test pattern mode, Test pattern resolution, Test pattern color
Digital video input ports (HDMI, DP, DVI-D)
Video port name, Audio port name, HDCP setting
Test pattern mode, Test pattern resolution, Test pattern color
TPS output port
Port name, HDCP mode, HDMI mode, Power +5V mode, Color space setting
Analog audio input ports
Port name, Volume, Balance
Crosspoint settings
Video crosspoint settings, audio crosspoint settings
Autoselect (enable/disable, delay settings, priority list)
Mute/lock state of video ports, Mute/lock state of audio ports
Serial ports (local and TPS)
RS-232 mode, Control protocol, Baud rate, Data bits, Stop bits, Parity
Port name and Command Injection (CI) port number
IR port
Port status (enable / disable), Code length, Repetition code, Modulation state
Input port name, Output port name
CI status (enable / disable), CI port number
Network settings
DHCP status (enable / disable), Static IP address, Network mask, Gateway address, LW2/LW3/HTTP port nr
Further settings
Device label, Control lock
User presets (U1-U32), User EDID data (U1-U15), Event Manager: settings of all Events (E1-E20)
GPIO port configuration (pin 1-7)

11.4. Cable Wiring Guide

11.4.1. Cable Wiring Guide for Serial Data Transmission

The standalone transmitters are built with 3-pole Phoenix connector. See below the two examples of the most common assembling cases.

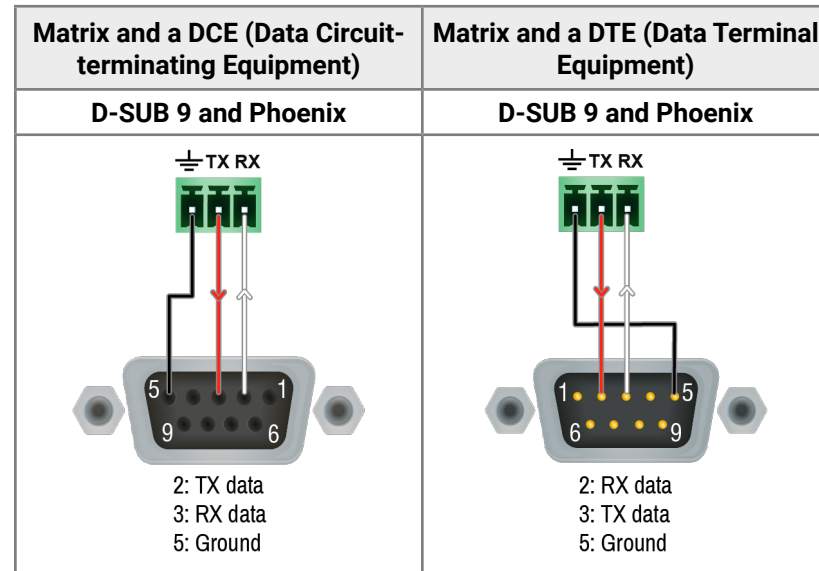

11.4.2. Audio Cable Wiring Guide

Inputs and outputs of audio devices are symmetric or asymmetric. The main advantage of the symmetric lines is the better protection against the noise therefore, they are widely used in the professional audio industry. Symmetric audio is most often referred to as balanced audio, as opposed to asymmetric, which is referred to as unbalanced audio. Lightware products are usually built with 5-pole Phoenix connectors so we would like to help users assembling their own audio cables. See the most common cases below.

ATTENTION! Symmetric and asymmetric lines can be linked with passive accessories (e.g. special cables), but in this case half of the line level is lost.

ATTENTION! There are numerous types of regularly used connector and cable types to connect audio devices. Please always make sure that a connector or cable fits your system before use.

ATTENTION! Never join the phase-inverted (negative, cold or -) poles (either right and left) to the ground or to each other on the output side, as this can damage the unit.

INFO: Use a galvanic isolation in case of a ground loop.

From Unbalanced Output to Balanced Input

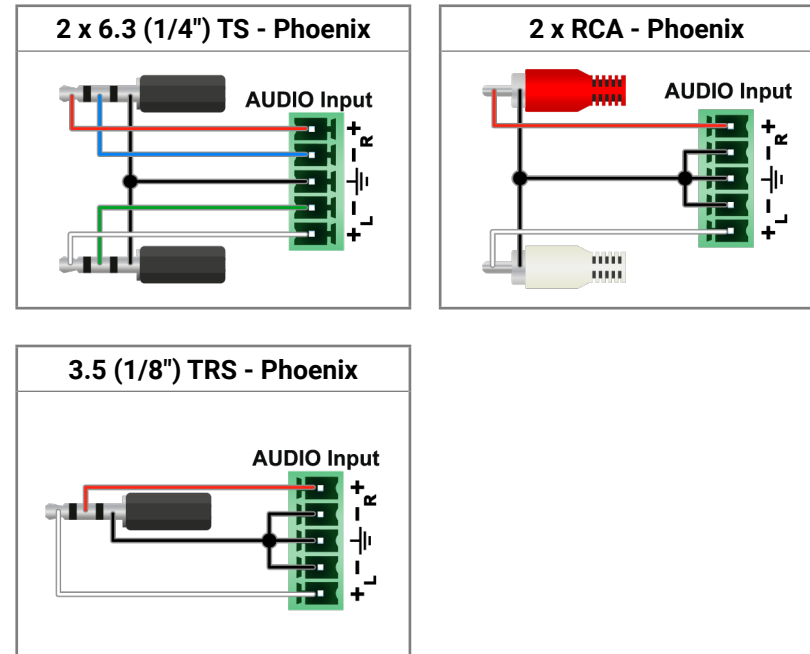

From Balanced Output to Balanced Input

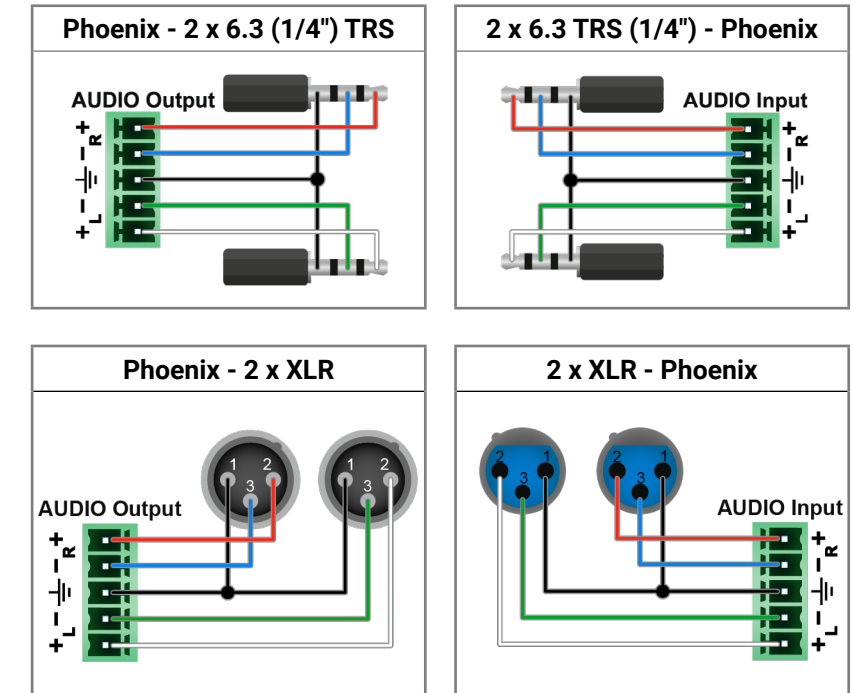

From Balanced Output to Unbalanced Input

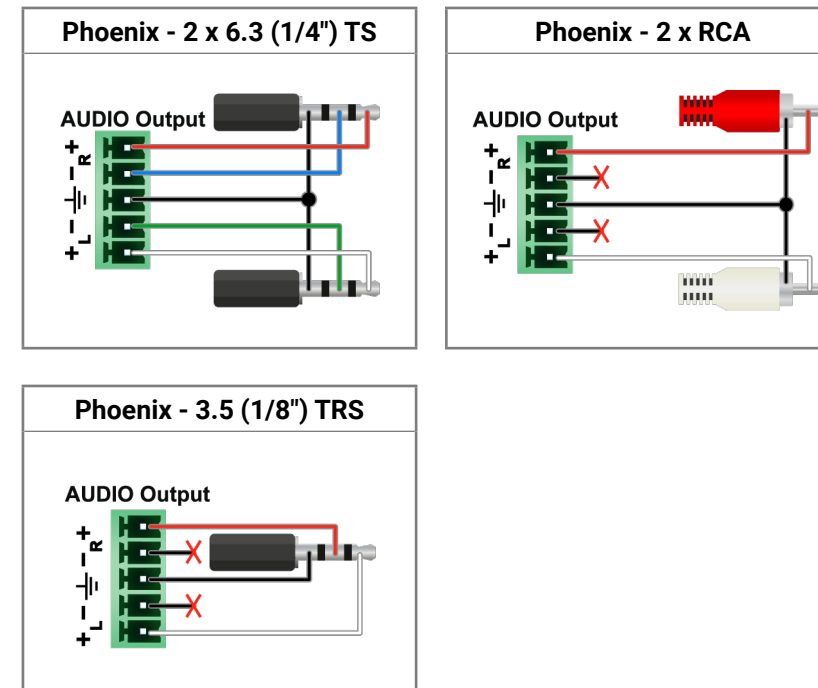

For more information about the cable wiring see the **Cable Wiring Guide** on our website <https://lightware.com/support/guides-and-white-papers>.

11.5. Mechanical Drawings

11.5.1. UMX-TPS-TX100 series

UMX-TPS-TX140 can be seen in the pictures, but the dimensions are the same for all standalone transmitter models.

Front View

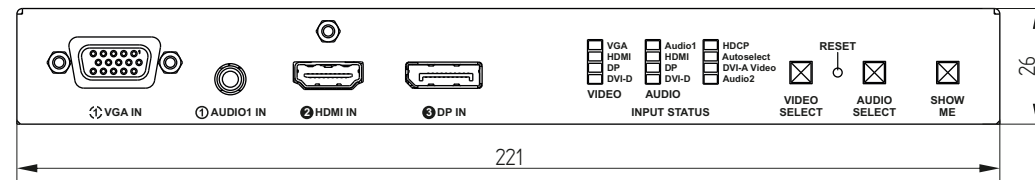

Rear View

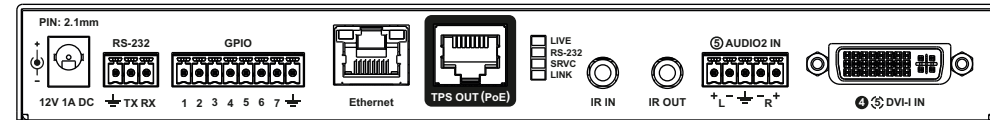

Bottom View

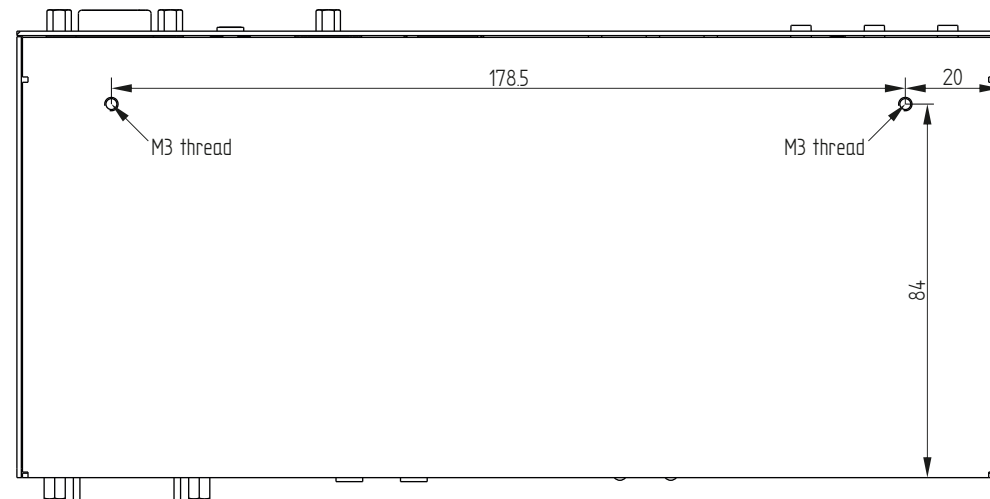

Top View

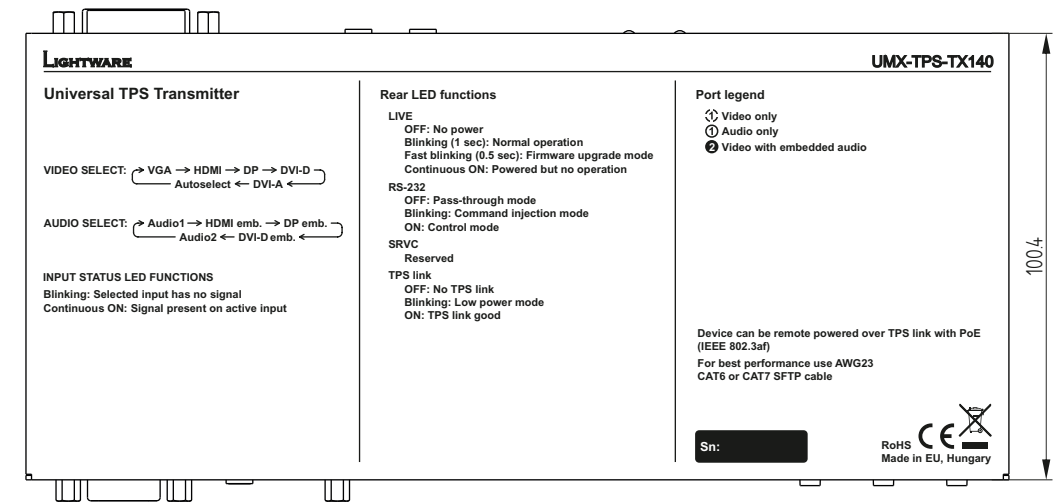

Side View

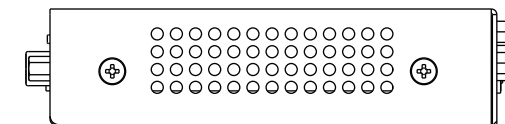

11.5.2. WP-UMX-TPS-TX100 series

WP-UMX-TPS-TX130-US can be seen in the pictures, but the dimensions are the same for all wall plate models. Dimensions are in mm.

Front View

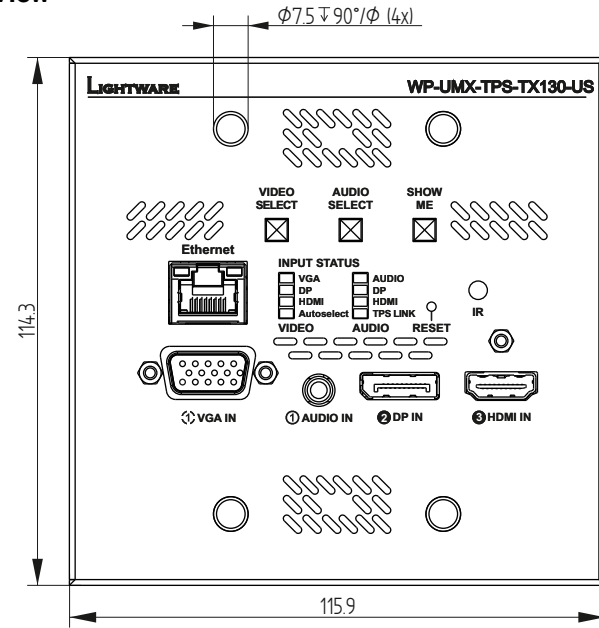

Rear View

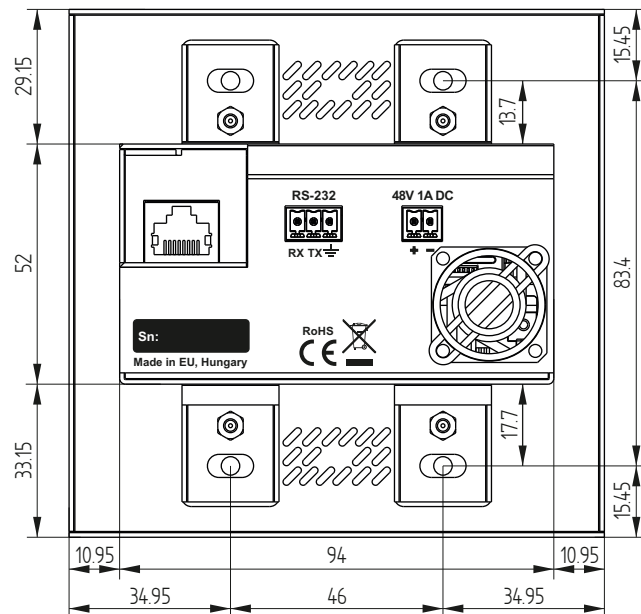

Side View

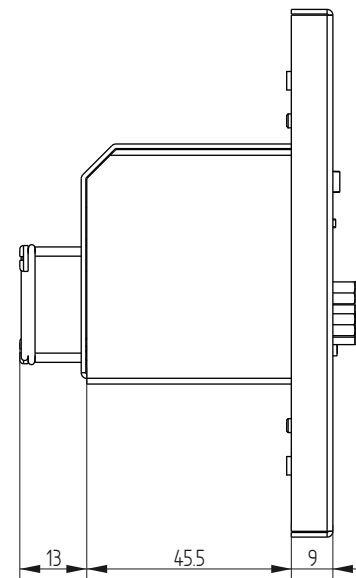

11.5.3. FP-UMX-TPS-TX100 series

FP-UMX-TPS-TX130 can be seen in the pictures, but the dimensions are the same for all floor plate models. Dimensions are in mm.

Front View

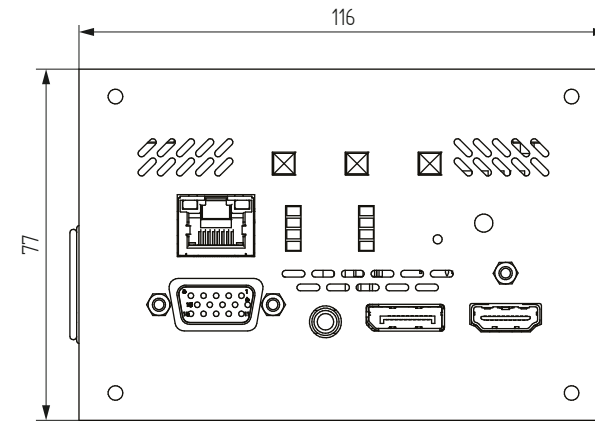

Rear View

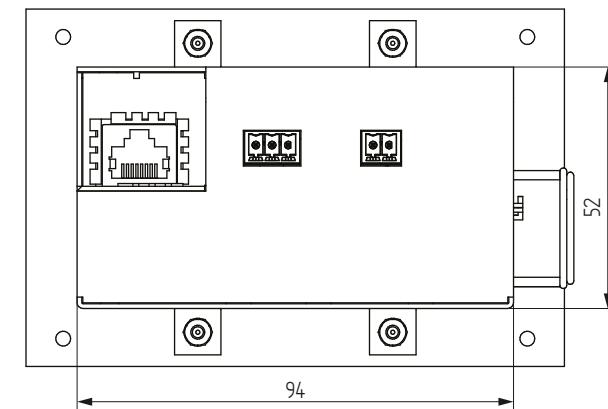

Side View

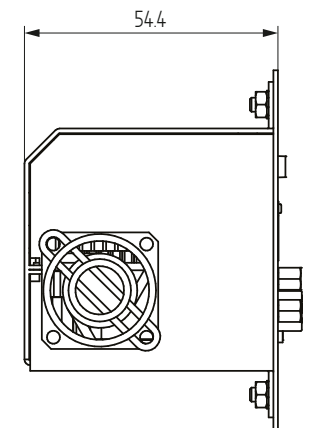

11.6. Port Numbering

11.6.1. WP-UMX-TPS-TX120-US

Audio/Video Ports

Port name	Video port nr. (LW2)	Video port nr. (LW3)		Emulated EDID memory	Audio port nr. (LW2)	Audio port nr. (LW3)	
		Till fw v1.0.3	From fw v1.1.0			Till fw v1.0.3	From fw v1.1.0
VGA in	I1	P1	I1	E1	-	-	-
HDMI in	I2	P2	I2	E2	I2	P2	I2
Test pattern	I3	P3	I3	-	-	-	-
Audio in	-	-	-	-	I1	P1	I1
TPS out	O1	P4	O1	-	O1	P3	O1

RS-232 and IR Ports

Port name	Port nr. (LW2 / LW3)
Local serial port	P1
TPS serial link	P2

Port name	Port nr. (LW2 / LW3)
Local IR input	S1
TPS IR input	S2

11.6.2. WP-UMX-TPS-TX130-US / WP-UMX-TPS-TX130-Plus-US

Audio/Video Ports

Port name	Video port nr. (LW2)	Video port nr. (LW3)		Emulated EDID memory	Audio port nr. (LW2)	Audio port nr. (LW3)	
		Till fw v1.0.3	From fw v1.1.0			Till fw v1.0.3	From fw v1.1.0
VGA in	I1	P1	I1	E1	-	-	-
DP in	I2	P2	I2	-	I2	P2	I2
HDMI in	I3	P3	I3	E2	I3	P3	I3
Test pattern	I4	P4	I4	-	-	-	-
Audio in	-	-	-	-	I1	P1	I1
TPS out	O1	P5	O1	-	O1	P4	O1

RS-232 and IR Ports

Port name	Port nr. (LW2 / LW3)
Local serial port	P1
TPS serial link	P2

Port name	Port nr. (LW2 / LW3)
Local IR input	S1
TPS IR input	S2

11.6.3. UMX-TPS-TX120

Audio/Video Ports

Port name	Video port nr. (LW2)	Video port nr. (LW3)		Emulated EDID memory	Audio port nr. (LW2)	Audio port nr. (LW3)	
		Till fw v1.0.3	From fw v1.1.0			Till fw v1.0.3	From fw v1.1.0
VGA in	I1	P1	I1	E1	-	-	-
HDMI in	I2	P2	I2	E2	I2	P2	I2
Test pattern	I3	P3	I3	-	-	-	-
Audio in	-	-	-	-	I1	P1	I1
TPS out	O1	P4	O1	-	O1	P3	O1

IR and RS-232 Ports

Port name	Port nr. (LW2 / LW3)
Local IR input	S1
Local IR output	D1
TPS IR input	S2
TPS IR output	D2

Port name	Port nr. (LW2 / LW3)
Local serial port	P1
TPS serial link	P2

11.6.4. UMX-TPS-TX130

Audio/Video Ports

Port name	Video port nr. (LW2)	Video port nr. (LW3)		Emulated EDID memory	Audio port nr. (LW2)	Audio port nr. (LW3)	
		Till fw v1.0.3	From fw v1.1.0			Till fw v1.0.3	From fw v1.1.0
VGA in	I1	P1	I1	E1	-	-	-
HDMI in	I2	P2	I2	E2	I2	P2	I2
DVI-D in	I3	P3	I3	E3	I3	P3	I3
DVI-A in	I4	P4	I4	E4	-	-	-
Test pattern	I5	P5	I5	-	-	-	-
Audio in	-	-	-	-	I1	P1	I1
TPS out	O1	P6	O1	-	O1	P4	O1

IR and RS-232 Ports

Port name	Port nr. (LW2 / LW3)
Local IR input	S1
Local IR output	D1
TPS IR input	S2
TPS IR output	D2

Port name	Port nr. (LW2 / LW3)
Local serial port	P1
TPS serial link	P2

11.6.5. UMX-TPS-TX140 / UMX-TPS-TX140-Plus

Audio/Video Ports

Port name	Video port nr. (LW2)	Video port nr. (LW3)		Emulated EDID memory	Audio port nr. (LW2)	Audio port nr. (LW3)	
		Till fw v1.0.3	From fw v1.1.0			Till fw v1.0.3	From fw v1.1.0
VGA in	I1	P1	I1	E1	-	-	-
HDMI in	I2	P2	I2	E2	I2	P2	I2
DP in	I3	P3	I3	E3	I3	P3	I3
DVI-D in	I4	P4	I4	E4	I4	P4	I4
DVI-A in	I5	P5	I5	E5	-	-	-
Test pattern	I6	P6	I6	-	-	-	-
Audio1 in	-	-	-	-	I1	P1	I1
Audio2 in	-	-	-	-	I5	P5	I5
TPS out	O1	P7	O1	-	O1	P6	O1

IR and RS-232 Ports

Port name	Port nr. (LW2 / LW3)
Local IR input	S1
Local IR output	D1
TPS IR input	S2
TPS IR output	D2

Port name	Port nr. (LW2 / LW3)
Local serial port	P1
TPS serial link	P2

11.6.6. FP-UMX-TPS-TX120

Audio/Video Ports

Port name	Video port nr. (LW2)	Video port nr. (LW3)	Emulated EDID memory	Audio port nr. (LW2)	Audio port nr. (LW3)
VGA in	1	I1	E1	-	-
HDMI in	2	I2	E2	2	I2
Test pattern	3	I3	-	-	-
Audio in	-	-	-	1	I1
TPS out	1	O1	-	1	O1

RS-232 and IR Ports

Port name	Port nr. (LW2 / LW3)
Local serial port	P1
TPS serial link	P2

Port name	Port nr. (LW2 / LW3)
Local IR input	S1
TPS IR input	S2
TPS IR output	D1

11.6.7. FP-UMX-TPS-TX130

Audio/Video Ports

Port name	Video port nr. (LW2)	Video port nr. (LW3)	Emulated EDID memory	Audio port nr. (LW2)	Audio port nr. (LW3)
VGA in	1	I1	E1	-	-
DP in	2	I2	-	2	I2
HDMI in	3	I3	E2	3	I3
Test pattern	4	I4	-	-	-
Audio in	-	-	-	1	I1
TPS out	1	O1	-	1	O1

RS-232 and IR Ports

Port name	Port nr. (LW2 / LW3)
Local serial port	P1
TPS serial link	P2

Port name	Port nr. (LW2 / LW3)
Local IR input	S1
TPS IR input	S2
TPS IR output	D1

11.7. Maximum Extension Distances

Resolution	Pixel clock rate	Cable lengths (Auto / Longreach TPS mode)		
		CAT5e AWG24	CAT7 AWG26**	CAT7 AWG23
1024x768@60Hz	65 MHz	100 m / 130 m*	90 m / 120 m*	120 m / 170 m*
1280x720p@60Hz	73.8 MHz	100 m / 130 m*	90 m / 120 m*	120 m / 170 m*
1920x1080p@60Hz / 24bpp	148.5 MHz	100 m / 130 m*	90 m / 120 m*	120 m / 170 m*
1920x1200@60Hz	152.9 MHz	100 m / NA	90 m / NA	120 m / NA
1600x1200@60Hz	162 MHz	100 m / NA	90 m / NA	120 m / NA
1920x1080@60Hz / 36bpp	223.6 MHz	70 m / NA	70 m / NA	100 m / NA
3840x2160@30Hz UHD	297 MHz	70 m / NA	70 m / NA	100 m / NA
4096x2160@30Hz 4K	297 MHz	70 m / NA	70 m / NA	100 m / NA

* With Long reach operation mode which supports pixel clock frequencies up to 148.5 MHz.

** When remote powering is used with AWG26 cables, distances are 20% shorter.

11.8. Factory EDID List

Mem.	Resolution	Type	Mem.	Resolution	Type
F1	640 x 480 @ 60.00 Hz	D	F34	720 x 576 @ 50.00 Hz	H
F2	848 x 480 @ 60.00 Hz	D	F35	1280 x 720 @ 50.00 Hz	H
F3	800 x 600 @ 60.32 Hz	D	F36	1280 x 720 @ 60.00 Hz	H
F4	1024 x 768 @ 60.00 Hz	D	F37	1920 x 1080i @ 50.04 Hz	H
F5	1280 x 768 @ 50.00 Hz	D	F38	1920 x 1080i @ 50.00 Hz	H
F6	1280 x 768 @ 59.94 Hz	D	F39	1920 x 1080i @ 60.05 Hz	H
F7	1280 x 768 @ 75.00 Hz	D	F40	1920 x 1080i @ 60.05 Hz	H
F8	1360 x 768 @ 60.02 Hz	D	F41	1920 x 1080 @ 24.00 Hz	H
F9	1280 x 1024 @ 50.00 Hz	D	F42	1920 x 1080 @ 25.00 Hz	H
F10	1280 x 1024 @ 60.02 Hz	D	F43	1920 x 1080 @ 30.00 Hz	H
F11	1280 x 1024 @ 75.02 Hz	D	F44	1920 x 1080 @ 50.00 Hz	H
F12	1400 x 1050 @ 50.00 Hz	D	F45	1920 x 1080 @ 60.00 Hz	H
F13	1400 x 1050 @ 60.00 Hz	D	F46	1920 x 1080 @ 60.00 Hz	H
F14	1400 x 1050 @ 75.00 Hz	D	F47	Universal_HDMI_PCM	H
F15	1680 x 1050 @ 60.00 Hz	D	F48	Universal_HDMI_ALL	H
F16	1920 x 1080 @ 50.00 Hz	D	F49	Universal_HDMI_DC	H
F17	1920 x 1080 @ 60.00 Hz	D	F50	720 x 480 @ 30.03 Hz	A
F18	2048 x 1080 @ 50.00 Hz	D	F51	720 x 576 @ 25.04 Hz	A
F19	2048 x 1080 @ 60.00 Hz	D	F52	640 x 480 @ 60.00 Hz	A
F20	1600 x 1200 @ 50.00 Hz	D	F53	640 x 480 @ 75.00 Hz	A
F21	1600 x 1200 @ 60.00 Hz	D	F54	800 x 600 @ 50.00 Hz	A
F22	1920 x 1200 @ 50.00 Hz	D	F55	800 x 600 @ 60.32 Hz	A
F23	1920 x 1200 @ 59.56 Hz	D	F56	800 x 600 @ 75.00 Hz	A
F24	2048 x 1200 @ 59.96 Hz	D	F57	1024 x 768 @ 49.99 Hz	A
F25-F28	Reserved	D	F58	1024 x 768 @ 60.00 Hz	A
F29	Universal_DVI	D	F59	1024 x 768 @ 75.03 Hz	A
F30	1440 x 480i @ 60.05 Hz	H	F60	1280 x 768 @ 50.00 Hz	A
F31	1440 x 576i @ 50.08 Hz	H	F61	1280 x 768 @ 59.94 Hz	A
F32	640 x 480 @ 59.95 Hz	H	F62	1280 x 768 @ 75.00 Hz	A
F33	720 x 480 @ 59.94 Hz	H	F63	1360 x 768 @ 60.02 Hz	A

Mem.	Resolution	Type	Mem.	Resolution	Type
F64	1364 x 768 @ 50.00 Hz	A	F95	Reserved	D
F65	1364 x 768 @ 59.94 Hz	A	F96	2560 x 1600 @ 59.86 Hz	D
F66	1364 x 768 @ 74.99 Hz	A	F97	3840 x 2400 @ 24.00 Hz	D
F67	1280 x 1024 @ 50.00 Hz	A	F98	1280 x 720 @ 60.00 Hz	H3D
F68	1280 x 1024 @ 60.02 Hz	A	F99	1920 x 1080 @ 60.00 Hz	H3D
F69	1366 x 1024 @ 60.00 Hz	A	F100	1024 x 768 @ 60.00 Hz	H
F70	1400 x 1050 @ 50.00 Hz	A	F101	1280 x 1024 @ 50.00 Hz	H
F71	1400 x 1050 @ 60.00 Hz	A	F102	1280 x 1024 @ 60.02 Hz	H
F72	1400 x 1050 @ 75.00 Hz	A	F103	1280 x 1024 @ 75.02 Hz	H
F73	1920 x 540 @ 50.00 Hz	A	F104	1600 x 1200 @ 50.00 Hz	H
F74	1920 x 540 @ 60.00 Hz	A	F105	1600 x 1200 @ 60.00 Hz	H
F75	1920 x 1080 @ 50.00 Hz	A	F106	1920 x 1200 @ 59.56 Hz	H
F76	1920 x 1080 @ 60.00 Hz	A	F107	2560 x 1440 @ 59.95 Hz	H
F77	1600 x 1200 @ 50.00 Hz	A	F108	2560 x 1600 @ 59.86 Hz	H
F78	1600 x 1200 @ 60.00 Hz	A	F109	3840 x 2400 @ 24.00 Hz	H
F79	1920 x 1200 @ 59.96 Hz	A	F110	3840 x 2160 @ 24.00 Hz	H
F80	1920 x 1200 @ 50.00 Hz	A	F111	3840 x 2160 @ 25.00 Hz	H
F81-F88	Reserved	A	F112	3840 x 2160 @ 30.00 Hz	H
F89	Universal_Analog	A	F113-F117	Reserved	
F90	1920 x 2160 @ 59.99 Hz	D	F118	Universal_4K_PCM	H4K
F91	1024 x 2400 @ 60.01 Hz	D	F119	Universal_4K_ALL	H4K
F92-F93	Reserved	D	F120	3840 x 2160 @ 60.00 Hz	H4K
F94	2048 x 1536 @ 60.00 Hz	D			

Legend

Type	Description
D	DVI EDID
H	HDMI EDID
A	Analog EDID
DL	Dual-Link DVI EDID
H3D	HDMI EDID with 3D support
H4K	HDMI EDID with 4K resolution support

11.9. Release Notes of the Firmware Packages

v1.4.0b8

Release date: 2019-07-23

New feature:

- KVM transmission between USB HID (Human Interface Devices, e.g. keyboard, mouse, presenter over PC or a Laptop) for UMX-TPS-TX140K only!
- Added support for FP-UMX-TPS-TX120-GES, FP-UMX-TPS-TX130-GES product variants.
- New bootloader is used, which allows the connected TPS-RX95's to be upgraded remotely.
- Crosspoint properties and methods changed. Warning: If you are using an external controller for this device via LW3 protocol, the recent changes in property and node names may result in difficulties to control the TPS device with the latest firmware.
- WP-UMX-TPS-TX100-WHITE products are now supported.
- The method of storing device settings in EEPROM is upgraded, which may result in losing all the settings, logs and user EDID's after upgrading to 1.1.0. The LDU software contains a plug-in to help you keep the actual settings after firmware upgrade.
- Event Manager configuration became more user friendly: actions can be triggered manually for testing and the user interface shows if any of the conditions are met.
- Event Manager upgraded: time delay can be configured between condition and action, a condition can trigger multiple actions at the same time, inverse condition can be used.
- 3840x2160p60 YUV4:2:0 factory EDID added.
- IR command injection is now supported: data received on a specific TCP port is transmitted as IR signal, and the received IR frames are also sent to this TCP connection.
- Fan can be controlled manually with setFan() LW3 method.
- EDID node properties changed: PreferredResolution, MonitorName and AudioInfo properties are added
- The device is able to identify IR commands on either the local or link IR input port. This feature can be connected to Event Manager, which means, that the device can be programmed to do various actions, if a specific IR command is detected.
- TCP and UDP messages can be sent by the device to control projectors and any other devices. This feature can also be used with Event Manager.

- Audio and video port names are changed: 'I' is used for inputs and 'O' is used for outputs, instead of 'P'.
- New EDID driver is used, the content of some factory EDID's are changed according to EDID 1.3 and 1.4 standard.
- Autoselection connect and disconnect delay can be configured via LW3 methods.
- Firmware platform library updated
- Sending IR codes (SendProntoHex e.g. send max. 200 Byte IR code with Event Actions) for UMX-TPS-TX140-Plus only!
- Added 'Disable default button function' option to support button customization in Event Manager
- Modified RS-232 modes to support SendMessage in Control mode
- CEC - sendCEC command (e.g. turn on the TV with Event Actions) for WP-UMX-TPS-TX130-Plus only!
- LWROS integration compatible for LDU2 only!
- Added 'Dark mode' function to turn off front panel LEDs
- Modified DP input driver to fix HDCP issue with MacBooks
- RS232 Minimal Recognizer for Cisco compatibility (Cisco Login) for WP-UMX-TPS-TX130-Plus only!
- Improved GPIO detection
- Use LDU2 v1.2.5 or later for the upgrade!
- Added 'User replaceable miniweb slot' to support built-in control webpage
- Added 'Forced button lock' function to lock buttons via protocol command

Bugfix:

- Poe enable state is now reloaded after reboot.
- Input video parameter measurement speed improved.
- Unsupported dual link DVI EDIDs removed from factory EDID list.
- /SYS/MB/UMXDP node renamed to /SYS/MB/DP
- Event manager conditions did not work if DP input properties were selected.
- If the user switched to the currently selected port, the output was disconnected and connected again unnecessarily, which resulted in a picture drop. Fixed.
- Compatibility issues with Gefen HDMI 1.3 HdBaseT extender fixed.

- In case of sending DVI signal on the output, the audio output port does not indicate signal present.
- If the output was set to HDCP Always mode, the signal was sent out unencrypted, if the input port was disconnected and connected again. This issue only happened, if the input signal was also unencrypted.
- If no sync screen is active, the output resolution is now reported correctly by the output port.
- Reporting the resolution of signals in YUV 4:2:0 colorspace fixed.
- In case of sending 1920x1200 no sync screen, the device did not notice the connection state changes on the inputs. Fixed.

v1.3.2b1

Release date: 2019-05-21

Bugfix:

- Use LDU2 v1.2.5 or later for the upgrade!

v1.3.1b1

Release date: 2019-04-17

Bugfix:

- bugfix to support for previous HW versions

v1.3.0b11

Release date: 2019-04-17

New feature:

- RS232 Minimal Recognizer for Cisco compatibility (Cisco Login) for UMX-TPS-TX140-Plus only!
- Sending IR codes (SendProntoHex e.g. send max. 200 Byte IR code with Event Actions) for UMX-TPS-TX140-Plus only!
- Use LDU2 v1.2.3 or later for the upgrade!
- CEC - sendCEC command (e.g. turn on the TV with Event Actions) for UMX-TPS-TX140-Plus only!

Bugfix:

- Fixed Event Manager condition linking

v1.2.1b8

Release date: 2019-01-29

New feature:

- Firmware platform library updated
- Modified DP input driver to fix HDCP issue with MacBooks
- Compatible for LDU2 only!
- Modified RS-232 modes to support SendMessage in Control mode
- Added 'Disable default button function' option to support button customization in Event Manager
- Added 'Forced button lock' function to lock buttons via protocol command
- Added 'Dark mode' function to turn off front panel LEDs
- Video crosspoint driver improvements
- AV input driver improvements
- Improved GPIO detection speed (quick impulses can be detected, even low as 80ms)

v1.1.7b2

Release date: 2018-05-18

Bugfix:

- Rs232 even parity parameter bug fixed.

v1.1.6b1

Release date: 2018-04-10

New feature:

- New control.html.

v1.1.5b1

Release date: 2018-03-01

New feature:

- New miniweb.

v1.1.3b1

Release date: 2017-10-18

Bugfix:

- Fixed GPIO PortUiCode.

v1.1.2b4

Release date: 2017-10-16

New feature:

- The text names of the ports are changed to be more precise, and less ambiguous.
- With too many devices connected, one can find it hard to pair the physically connected devices with the listed devices in LDC device discovery window. That is why Lightware is introducing the new IdentifyMe feature, which identifies the desired device by blinking its LEDs for a period of time. That helps the user visually recognize the requested device.
- Now Bonjour shows firmware version as well.

Bugfix:

- Fixed a bug that made the 'continuously exists' timing mode unable to use.
- Fixed a bug that caused Event Manager's 47th event to be unlinkable.

v1.1.1b1

Release date: 2016-05-11

New feature:

- Autoselection connect and disconnect delay can be configured via LW3 methods.

Bugfix:

- Unsupported dual link DVI EDIDs removed from factory EDID list.
- Event manager conditions did not work if DP input properties were selected.
- Input background measurement speed improved.
- If the user switched to the currently selected port, the output was disconnected and connected again unnecessarily, which resulted in a picture drop. Fixed.
- /SYS/MB/UMXDP node renamed to /SYS/MB/DP

v1.1.0b1

Release date: 2016-04-11

New feature:

- New EDID driver is used, the content of some factory EDID's are changed according to EDID 1.3 and 1.4 standard.
- EDID node properties changed: PreferredResolution, MonitorName and AudioInfo properties are added
- Audio and video port names are changed: 'I' is used for inputs and 'O' is used for outputs, instead of 'P'.
- Crosspoint properties and methods changed. Warning: If you are using an external controller for this device via LW3 protocol, the recent changes in property and node names may result in difficulties to control the TPS device with the latest firmware.
- TCP and UDP messages can be sent by the device to control projectors and any other devices. This feature can also be used with Event Manager.
- IR command injection is now supported: data received on a specific TCP port is transmitted as IR signal, and the received IR frames are also sent to this TCP connection.
- The device is able to identify IR commands on either the local or link IR input port. This feature can be connected to Event Manager, which means, that the device can be programmed to do various actions, if a specific IR command is detected.
- Factory default can be given in the board component.
- New bootloader is used, which allows the connected TPS-RX95's to be upgraded remotely.
- Event Manager upgraded: time delay can be configured between condition and action, a condition can trigger multiple actions at the same time, inverse condition can be used.
- Dynamic edid can be deleted from code.
- 3840x2160p60 YUV4:2:0 factory EDID added.

- Event Manager configuration became more user friendly: actions can be triggered manually for testing and the user interface shows if any of the conditions are met.
- FRAMEWORK update.BUGFIX: Minor bug fix in default emulated edids.
- The method of storing device settings in EEPROM is upgraded, which may result in losing all the settings, logs and user EDID's after upgrading to 1.1.0. The LDU software contains a plug-in to help you keep the actual settings after firmware upgrade.
- Default emulated edid for UmxAvgFrontend handling changed.

Bugfix:

- Error log is accessible at /MANAGEMENT/LOG/RAMLOG node.
- If no sync screen is active, the output resolution is now reported correctly by the output port.
- Compatibility issues with Gefen HDMI 1.3 HdBaseT extender fixed.
- Reporting the resolution of signals in YUV 4:2:0 colorspace fixed.
- In case of sending DVI signal on the output, the audio output port does not indicate signal present.
- In case of sending 1920x1200 no sync screen, the device did not notice the connection state changes on the inputs. Fixed.
- If the output was set to HDCP Always mode, the signal was sent out unencrypted, if the input port was disconnected and connected again. This issue only happened, if the input signal was also unencrypted.
- Poe enable wasn't saved.
- Cable diagnostics properties are moved to SYS/MB/TPS/REMOTE node.

11.10. Hashtag Keyword List

This user's manual contains keywords with hashtag (#) to help you to find the relevant information as quick as possible.

The format of the keywords is the following:

#<keyword>

The usage of the keywords: use the **Search** function (Ctrl+F / Cmd+F) of your PDF reader application, type the # (hashtag) character and the wished keyword.

The **#new** special keyword indicates a new feature/function or model that has just appeared in the latest firmware or software version.

Example

#dhcp

This keyword is placed at the DHCP (dynamic IP address) setting in the front panel operation, the Lightware Device Controller (LDC) and the LW3 programmer's reference section.

The following list contains all hashtag keywords placed in the document with a short description belonging to them. The list is in **alphabetical order** by the hashtag keywords.

Hashtag Keyword ↓	Description
Tag	Description
#advancedview	Advanced view window
#analogaudio	Analog audio related settings
#audio	Audio related settings
#backup	Configuration cloning (backup)
#balance	Balance (for analog audio) setting
#builtinweb	Built-in web
#button	Front panel button operations
#cablediagnostics	Cable diagnostics
#cec	CEC related settings
#commandinjection	Command injection settings
#configurationcloning	Configuration cloning (backup)
#controllock	Front panel control lock
#controlprotocol	Control protocol (LW2 / LW3) query
#crosspoint	Crosspoint switch setting
#darkmode	Dark mode setting
#devicelabel	Device label
#dhcp	Dynamic IP address (DHCP) setting
#edid	EDID related settings
#factorydefault	Restore factory default settings
#firmwareversion	Firmware version query
#framedetector	Frame detector in LDC/built-in web
#hdcv	HDCP-encryption related setting
#ipaddress	IP address related settings
#identifyme	Identify me
#kvm	USB data transmission

Hashtag Keyword ↓	Description
#label	Device label
#lock	Port lock settings
#mute	Port mute setting
#network	Network (IP address) related settings
#nosyncscreen	Test pattern (no sync screen) settings
#power	Power supply and redundancy related information
#reboot	Restarting the device
#reset	Restarting the device
#restart	Restarting the device
#rs232	RS-232 related settings
#rs-232	RS-232 related settings
#serial	RS-232 related settings
#status	Status query
#switch	Crosspoint switch setting
#terminal	Advanced view window
#testpattern	Test pattern (no sync screen) settings
#tpsmode	TPS (HdBaseT) mode setting
#unlock	Port unlock settings
#unmute	Port unmute setting
#usbkvm	USB data transmission
#volume	Volume (for analog audio) setting
#web	Built-in web

11.11. Further Information

Limited Warranty Statement

1. Lightware Visual Engineering LLC (Lightware) warrants to all trade and end user customers that any Lightware product purchased will be free from manufacturing defects in both material and workmanship for three (3) years from purchase unless stated otherwise below. The warranty period will begin on the latest possible date where proof of purchase/delivery can be provided by the customer. In the event that no proof can be provided (empty 'Date of purchase' field or a copy of invoice), the warranty period will begin from the point of delivery from Lightware.

1.1. 25G and MODEX product series will be subject to a seven (7) year warranty period under the same terms as outlined in this document.

1.2. If during the first three (3) months of purchase, the customer is unhappy with any aspect of a Lightware product, Lightware will accept a return for full credit.

1.3. Any product that fails in the first six (6) months of the warranty period will automatically be eligible for replacement and advanced replacement where available. Any replacements provided will be warranted for the remainder of the original unit's warranty period.

1.4. Product failures from six (6) months to the end of the warranty period will either be repaired or replaced at the discretion of Lightware. If Lightware chooses to replace the product then the replacement will be warranted for the remainder of the original unit's warranty period.

2. The above-stated warranty and procedures will not apply to any product that has been:

2.1. Modified, repaired or altered by anyone other than a certified Lightware engineer unless expressly agreed beforehand.

2.2. Used in any application other than that for which it was intended.

2.3. Subjected to any mechanical or electrical abuse or accidental damage.

2.4. Any costs incurred for repair/replacement of goods that fall into the above categories (2.1., 2.2., 2.3.) will be borne by the customer at a pre-agreed figure.

3. All products to be returned to Lightware require a return material authorization number (RMA) prior to shipment and this number must be clearly marked on the box. If an RMA number is not obtained or is not clearly marked on the box, Lightware will refuse the shipment.

3.1. The customer will be responsible for in-bound and Lightware will be responsible for out-bound shipping costs.

3.2. Newly repaired or replaced products will be warranted to the end of the originally purchased products warranty period.

Document Revision History

Rev.	Release date	Changes	Editor
1.0	26-09-2014	Initial version	Laszlo Zsedenyi
2.3	22-08-2019	Added supplement in connection with WP-UMX-TPS-TX130-Plus-US model, added MKS mounting option for FP-UMX-TPS-TX100 series models	Tamas Forgacs
2.4	25-02-2019	Added supplement in connection with UMX-TPS-TX140K model.	Judit Barsony

Contact Us

sales@lightware.com

+36 1 255 3800

support@lightware.com

+36 1 255 3810

Lightware Visual Engineering LLC.
Peterdy 15, Budapest H-1071, Hungary

www.lightware.com

©2020 Lightware Visual Engineering. All rights reserved. All trademarks mentioned are the property of their respective owners. Specifications subject to change without notice.